



US00D937581S

(12) **United States Design Patent**
Zhang

(10) **Patent No.:** **US D937,581 S**

(45) **Date of Patent:** **** Dec. 7, 2021**

(54) **HAIR BEAUTIFICATION COMB**
(71) Applicant: **Zhongshan Okay Plastics & Electronic Co., Ltd, Zhongshan (CN)**
(72) Inventor: **Rangming Zhang, Zhongshan (CN)**
(73) Assignee: **Zhongshan Okay Plastics & Electronic Co., Ltd., Guangdong (CN)**
(**) Term: **15 Years**

D401,382 S * 11/1998 Seifert D28/13
D442,331 S * 5/2001 Pannozzo D28/7
7,201,764 B2 * 4/2007 Pearl A61N 5/0617
607/88
D599,954 S * 9/2009 Michaels D28/30
D631,604 S * 1/2011 Michaels D28/30
D716,493 S * 10/2014 Michaels A45D 24/00
D28/30
D827,198 S * 8/2018 Abdul D28/13
D906,678 S * 1/2021 Ge D4/100
D924,483 S * 7/2021 Zhang D28/25
2020/0297094 A1 * 9/2020 Sun A45D 24/04

* cited by examiner

(21) Appl. No.: **29/732,991**
(22) Filed: **Apr. 29, 2020**

Primary Examiner — Karen E Eldridge Powers
(74) *Attorney, Agent, or Firm* — Patrick J Halloran

(30) **Foreign Application Priority Data**

Jan. 17, 2020 (CN) 202030032897.2

(51) **LOC (13) Cl.** **28-03**
(52) **U.S. Cl.**
USPC **D4/100; D4/134**

(58) **Field of Classification Search**
USPC D4/100, 102, 114, 115, 116, 117, 118,
D4/119, 120, 121, 122, 123, 124, 125,
D4/126, 127, 128, 129, 130, 131, 132,
D4/133, 134, 135, 136, 137, 138, 199;
D24/214, 215; D28/13, 63, 15, 18, 21,
D28/24, 25, 30, 35, 7; D30/158, 159
CPC A46B 5/02; A46B 9/023; A46B 5/0095;
A46B 15/0051; A46B 2200/104
See application file for complete search history.

(56) **References Cited**

U.S. PATENT DOCUMENTS

D383,874 S * 9/1997 Rizzuto D28/18
D401,381 S * 11/1998 Seifert D28/18

(57) **CLAIM**

I claim the ornamental design for a hair beautification comb, as shown and described.

DESCRIPTION

FIG. 1 is a rear perspective view of the hair beautification comb showing my new design;
FIG. 2 is a front perspective view thereof;
FIG. 3 is a front elevation view thereof;
FIG. 4 is a rear elevation view thereof;
FIG. 5 is a left-side elevation view thereof;
FIG. 6 is a right-side elevation view thereof;
FIG. 7 is a top plan view thereof; and,
FIG. 8 is a bottom plan view thereof.
The broken lines shown in the drawings are for the purpose of illustrating portions of the hair beautification comb that form no part of the claimed design.

1 Claim, 8 Drawing Sheets

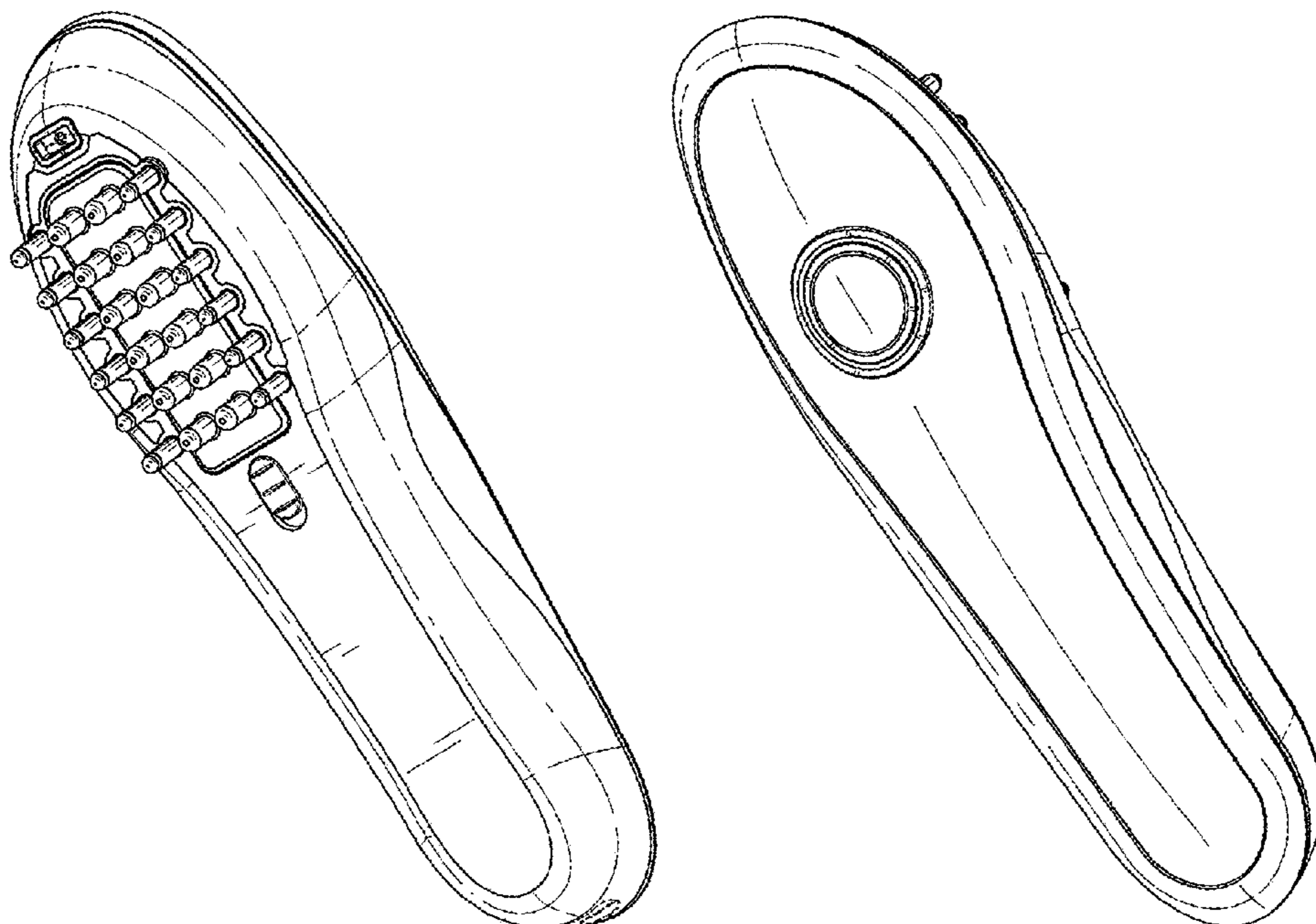

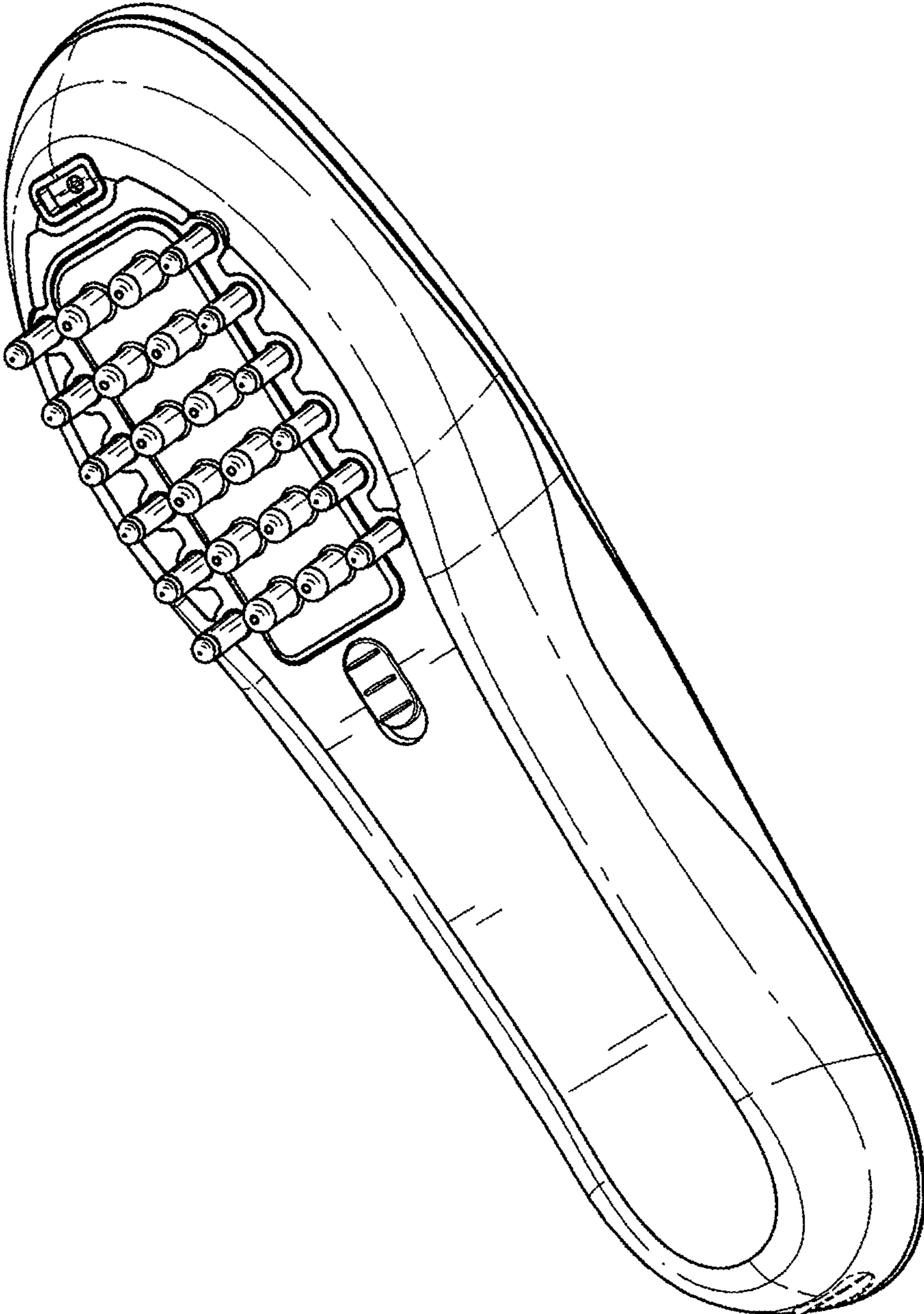

FIG. 1

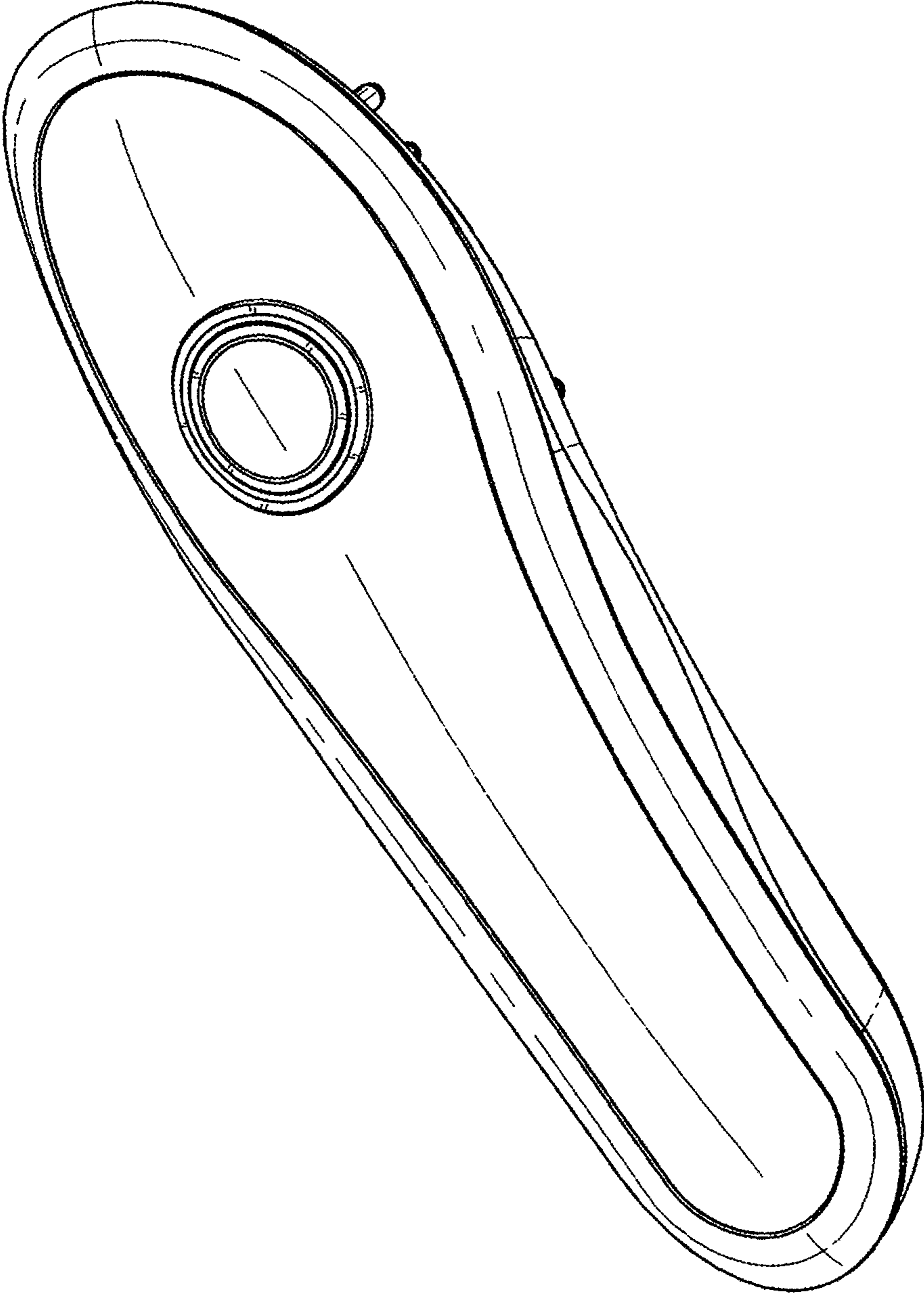

FIG. 2

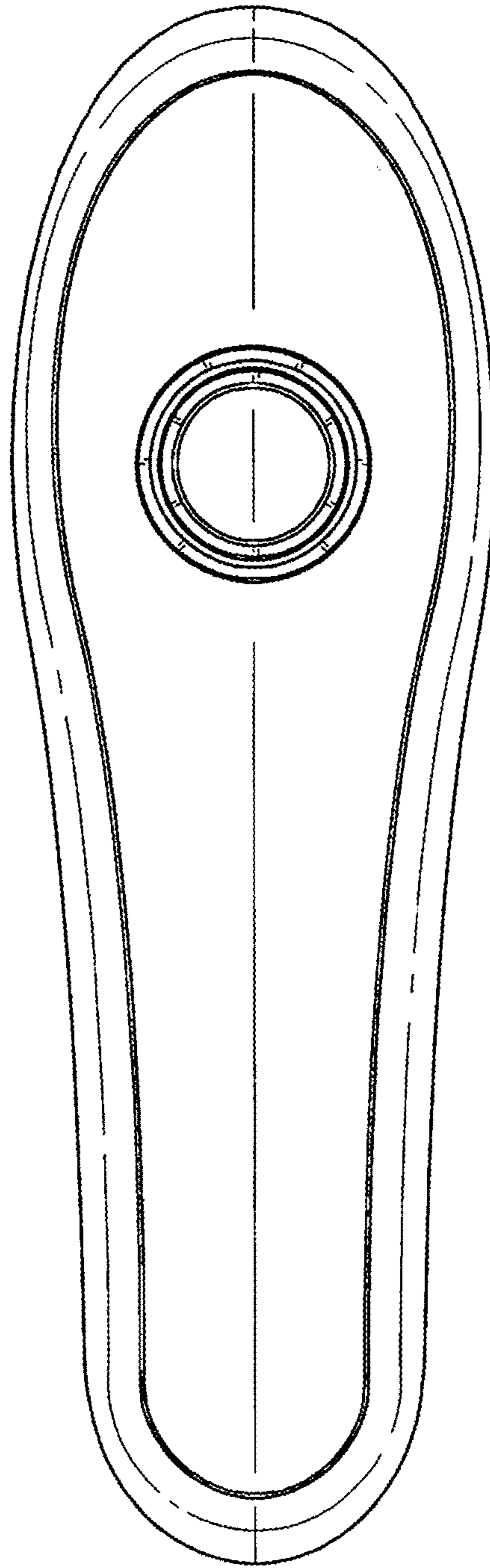

FIG. 3

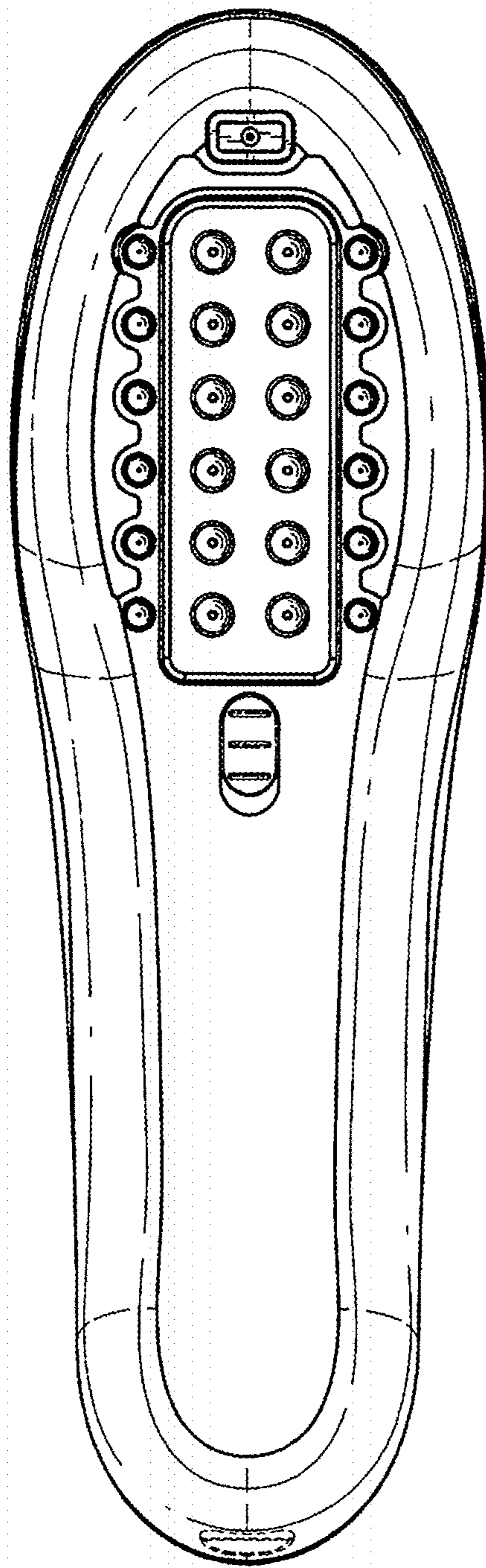

FIG. 4

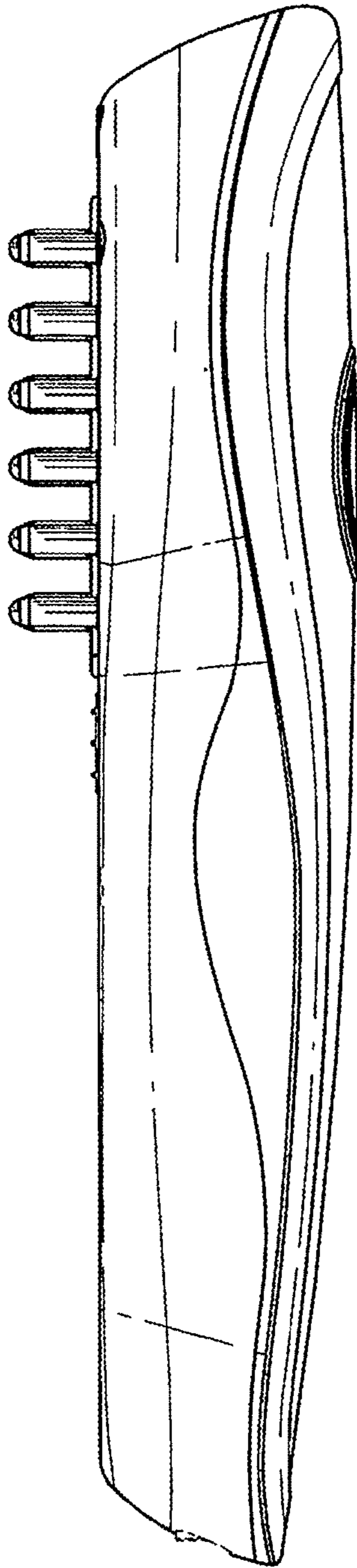

FIG. 5

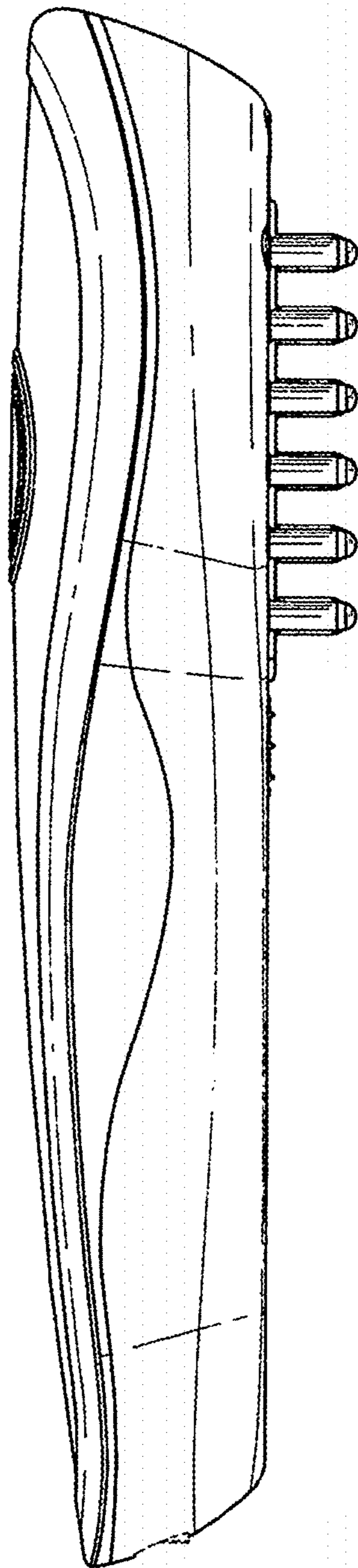

FIG. 6

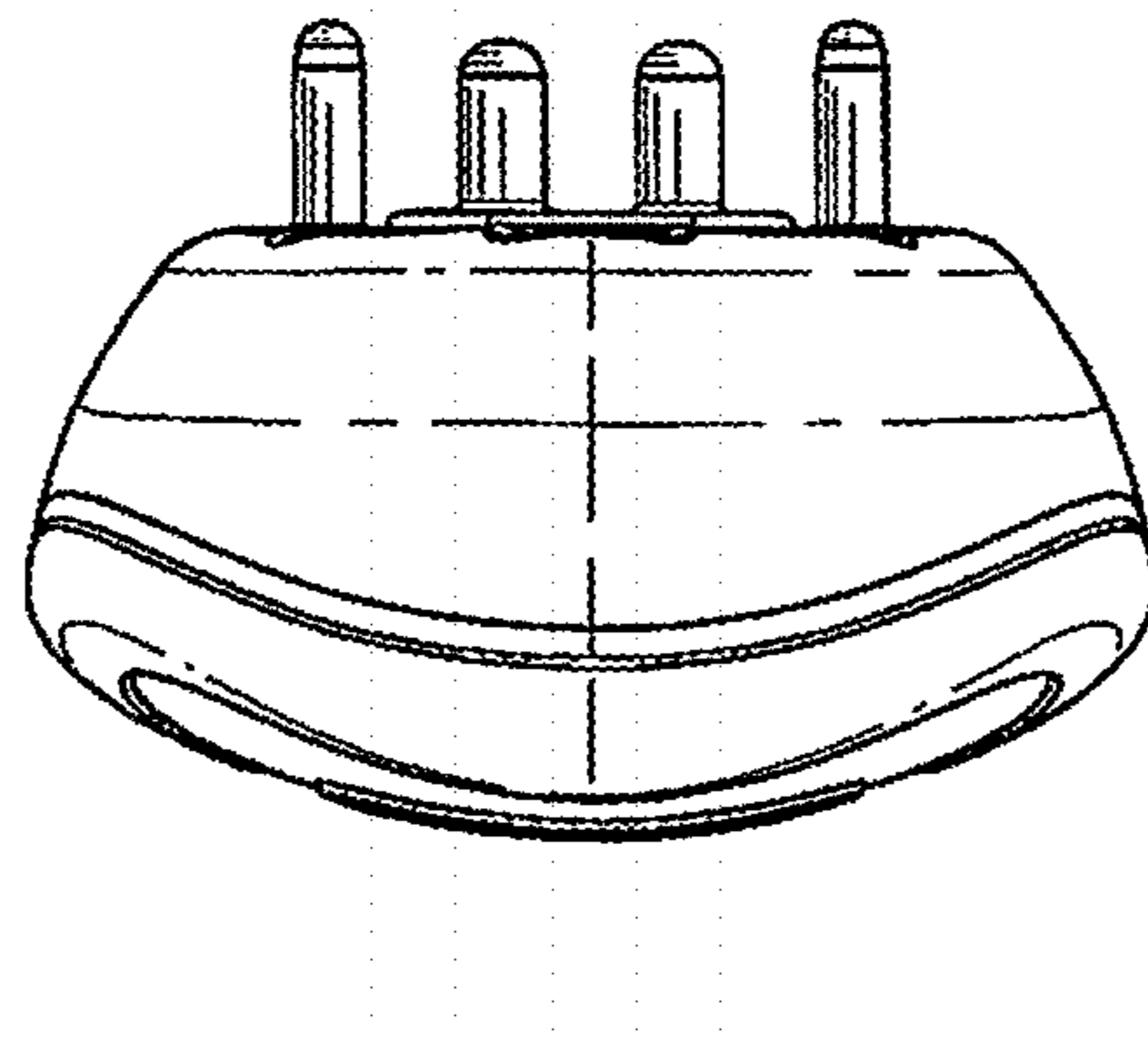

FIG. 7

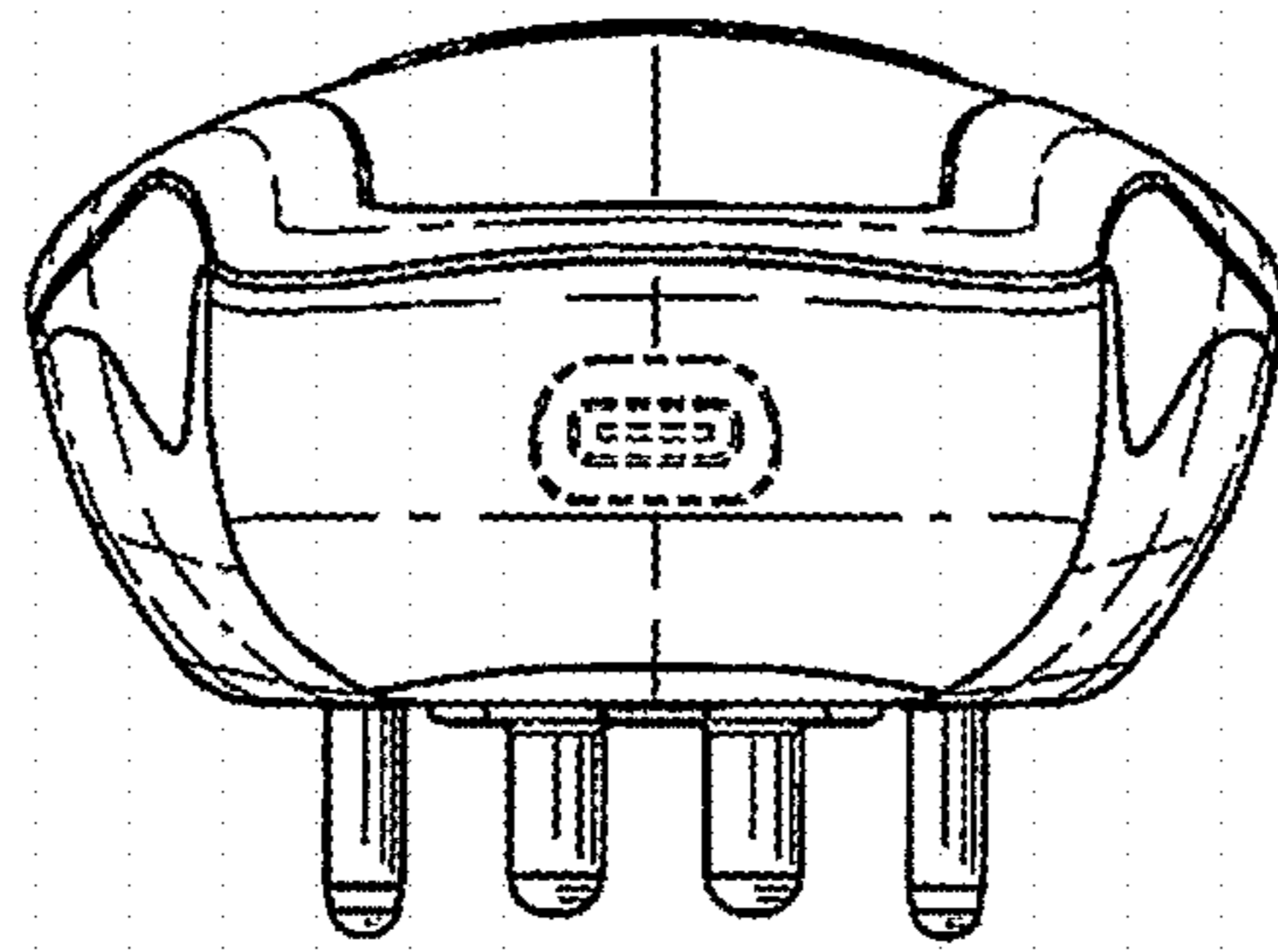

FIG. 8