



US00D937579S

(12) **United States Design Patent** (10) **Patent No.:** **US D937,579 S**  
**Cruice et al.** (45) **Date of Patent:** **\*\* Dec. 7, 2021**

(54) **TRAVEL CASE FOR A DEVICE**

FOREIGN PATENT DOCUMENTS

(71) Applicant: **Nicoventures Trading Limited**,  
London (GB)

CN 301525690 4/2011  
DE 402017100712-0007 S 1/2018

(Continued)

(72) Inventors: **Anthony Cruice**, London (GB);  
**Ainsley Cox**, London (GB)

OTHER PUBLICATIONS

(73) Assignee: **Nicoventures Trading Limited**,  
London (GB)

Vape Pen Pouch, unknown first availability date, cedarandfinch.com  
[online], [site visited Jan. 13, 2021], Available at internet URL:  
<https://cedarandfinch.com/vape-pouch.html> (Year: 2021).\*

(Continued)

(\*\*) Term: **15 Years**

(21) Appl. No.: **29/718,110**

*Primary Examiner* — Jeffrey D Asch

(22) Filed: **Dec. 20, 2019**

*Assistant Examiner* — Caitlin A Lavery

(30) **Foreign Application Priority Data**

(74) *Attorney, Agent, or Firm* — Patterson Thuent  
Pedersen, P.A.

Jun. 21, 2019 (EM) ..... 006590733

Aug. 8, 2019 (EM) ..... 006691721

(51) **LOC (13) Cl.** ..... **03-01**

(57) **CLAIM**

(52) **U.S. Cl.**

We claim the ornamental design for a travel case for a  
device, as shown.

USPC ..... **D3/299**; D27/189

(58) **Field of Classification Search**

**DESCRIPTION**

USPC ..... D3/203.1–203.3, 203.6, 205, 206, 219,  
D3/226, 227, 230, 232, 242, 243,  
D3/245–247, 249–251, 253, 258, 267,  
D3/268, 273–276, 283–291, 294, 295,  
D3/299–301, 303, 900, 901, 903;  
D7/602, 605, 607, 701, 703, 709;  
D9/701, 707, 709; D19/102, 106;  
D27/172, 173, 180, 185–187, 189–191,  
D27/193, 175, 183; D28/73, 76

FIG. 1 is a top perspective view of a travel case for a device.  
FIG. 2 is a front elevational view of the travel case for a  
device depicted in FIG. 1.  
FIG. 3 is a rear elevational view of the travel case for a  
device depicted in FIG. 1.  
FIG. 4 is a left side elevational view of the travel case for a  
device depicted in FIG. 1.  
FIG. 5 is a right side elevational view of the travel case for  
a device depicted in FIG. 1.  
FIG. 6 is a top plan view of the travel case for a device  
depicted in FIG. 1; and,  
FIG. 7 is a bottom plan view of the travel case for a device  
depicted in FIG. 1.

(Continued)

(56) **References Cited**

**1 Claim, 5 Drawing Sheets**

U.S. PATENT DOCUMENTS

49,307 A 8/1865 Saarbach  
109,365 A 11/1870 King

(Continued)

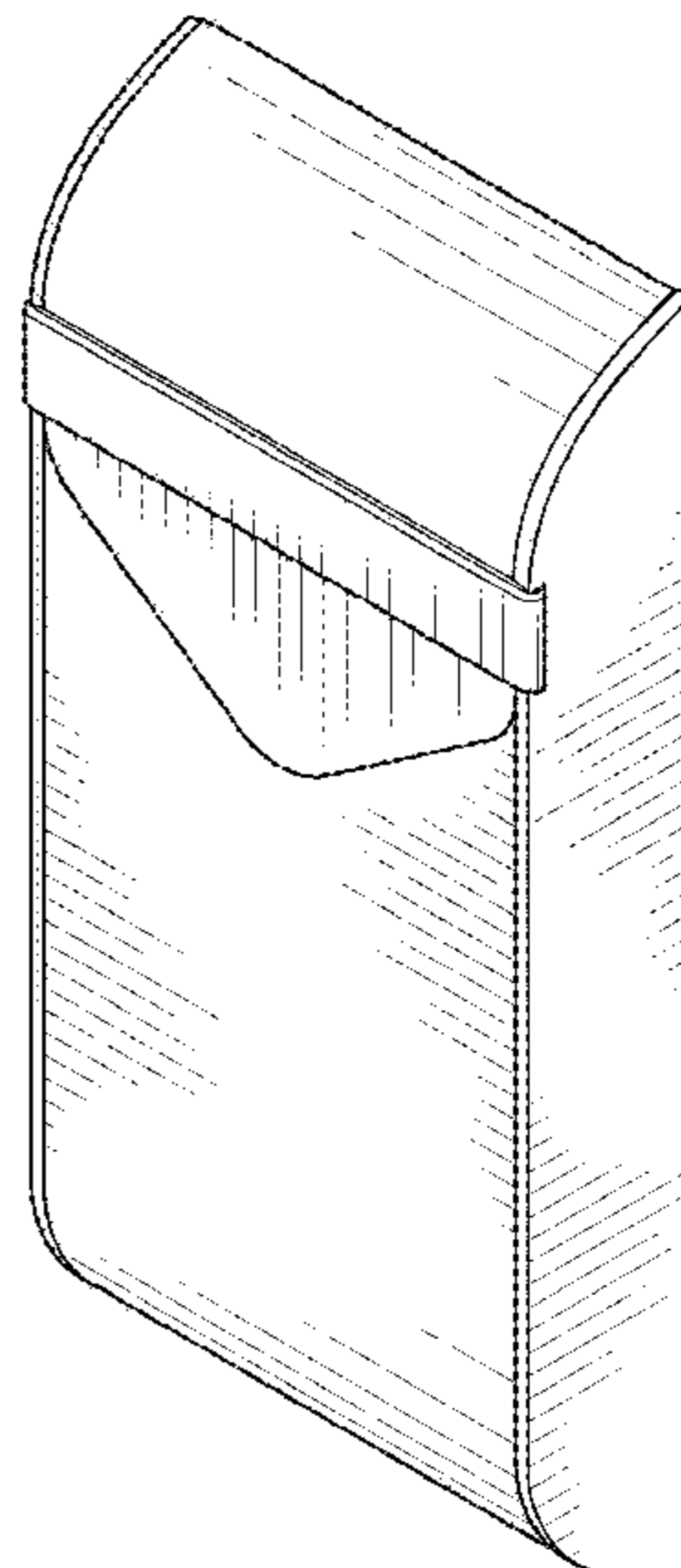

(58) **Field of Classification Search**

CPC .... A45C 1/02; A45C 1/04; A45C 1/06; A45C 1/024; A45C 3/00; A45C 3/02; A45C 3/04; A45C 3/06; A45C 3/08; A45C 3/004; A45C 5/00; A45C 5/02; A45C 5/03; A45C 5/04; A45C 5/06; A45C 5/005; A45C 7/00; A45C 7/0036; A45C 7/0086; A45C 7/059; A45C 9/00; A45C 11/00; A45C 11/16; A45C 11/24; A45C 11/26; A45C 11/38; A45C 11/008; A45C 13/02; A45C 13/08; A45C 13/26; A45C 13/30; A45C 13/185; A45C 15/00; A45C 2003/007; A45C 2003/008; A45C 2011/003; A45C 2011/007; A45C 2200/05; A45C 2200/10; A45F 5/00; A45F 5/02; A45F 5/021; A45F 2200/02; A45F 2200/0525; B65D 75/00; B65D 85/00; B65D 85/68

See application file for complete search history.

(56) **References Cited**

U.S. PATENT DOCUMENTS

175,171 A 3/1876 Rumpp  
 489,426 A 1/1893 Wientge  
 779,742 A 1/1905 Schultze  
 814,205 A 3/1906 Hawes  
 D45,341 S 3/1914 King Horne  
 1,285,602 A 11/1918 Bloomberg  
 1,463,619 A \* 7/1923 Gardner ..... A63F 1/06  
 206/39.4  
 1,584,774 A 5/1926 Henry et al.  
 D74,480 S 2/1928 Cowan  
 1,722,507 A 7/1929 Stanley  
 D98,251 S 1/1936 Hassenfeld  
 D127,283 S 5/1941 Schwalbe  
 2,335,051 A 11/1943 Gardner  
 D139,199 S 10/1944 Treganowen  
 D147,254 S \* 8/1947 Streng ..... D3/205  
 D157,742 S 3/1950 Dixon  
 D161,264 S 12/1950 Jeffery  
 2,598,070 A 5/1952 Horace et al.  
 D168,393 S 12/1952 Bourcart  
 2,700,492 A \* 1/1955 Baetzing ..... A45C 11/34  
 224/240  
 2,774,404 A \* 12/1956 Houghton ..... A45C 1/06  
 150/136  
 2,851,754 A \* 9/1958 Ecker ..... A45C 11/24  
 24/67 R  
 2,968,393 A \* 1/1961 Phillips, Jr. .... B65D 85/18  
 206/296  
 3,557,853 A \* 1/1971 Jones ..... B65D 33/24  
 383/86  
 D240,823 S 8/1976 Burke  
 D266,201 S 9/1982 Berman  
 D266,204 S 9/1982 Berman  
 D268,785 S \* 4/1983 Sommers ..... D24/226  
 D270,968 S 10/1983 Boal  
 D279,508 S 7/1985 Bauer et al.  
 D287,786 S 1/1987 Knight  
 D291,745 S 9/1987 Hansen  
 4,893,739 A 1/1990 Conner  
 D326,016 S 5/1992 Guaresi  
 D372,858 S \* 8/1996 Sunley ..... 383/25  
 D399,596 S 10/1998 Underwood  
 D408,098 S 4/1999 Stosky  
 D421,568 S \* 3/2000 Ferguson ..... D9/420  
 D426,018 S 5/2000 White  
 D438,008 S 2/2001 Snider  
 D466,412 S \* 12/2002 Baskinger ..... D9/432  
 D485,980 S 2/2004 Moses  
 D491,355 S 6/2004 Sloat  
 6,884,081 B1 4/2005 Ovadia

D518,954 S 4/2006 Wald  
 D529,283 S 10/2006 Vivar et al.  
 D532,558 S 11/2006 Jackel-Marken  
 D557,490 S \* 12/2007 Fedon ..... D3/206  
 D558,392 S 12/2007 Van Keppel et al.  
 D566,329 S 4/2008 Bagaric et al.  
 D573,303 S 7/2008 Fuente  
 D577,191 S 9/2008 Moldovan  
 D595,454 S 6/2009 Fuente  
 D596,350 S 7/2009 Fuente  
 D596,788 S 7/2009 Fuente  
 D596,842 S 7/2009 Cooper  
 D624,311 S 9/2010 Krakoff  
 D660,592 S 5/2012 Mecchella  
 D693,964 S 11/2013 Loyd  
 D694,012 S 11/2013 Hyzdu  
 8,667,998 B1 3/2014 Westrick  
 D730,042 S 5/2015 Slimane  
 9,031,401 B1 5/2015 Appelbaum et al.  
 D756,036 S \* 5/2016 Heilman ..... D28/76  
 D756,800 S 5/2016 Fenech, III  
 D775,820 S 1/2017 Sassi  
 D779,282 S \* 2/2017 Patten ..... D7/602  
 D794,120 S 8/2017 Takemura  
 D799,206 S \* 10/2017 Smith ..... D3/232  
 D812,902 S 3/2018 Derusha  
 D817,636 S 5/2018 Maier  
 D823,597 S 7/2018 Krainz  
 10,236,708 B2 3/2019 Schennum et al.  
 D868,457 S 12/2019 Hagerman  
 D876,822 S 3/2020 Kim  
 D886,448 S 6/2020 Zhang  
 10,750,779 B2 8/2020 Schennum et al.  
 D900,467 S 11/2020 Yang  
 D914,535 S 3/2021 Hack  
 2002/0020727 A1 2/2002 Huggins, Jr.  
 2004/0016658 A1 \* 1/2004 Le ..... A45C 11/00  
 206/305  
 2007/0000965 A1 1/2007 Cannon, Jr.  
 2007/0068982 A1 3/2007 Grundy et al.  
 2010/0147736 A1 6/2010 West et al.  
 2010/0230459 A1 \* 9/2010 Barbier ..... A45C 11/008  
 224/660  
 2010/0320246 A1 12/2010 Taylor  
 2013/0068641 A1 \* 3/2013 Puglisi ..... A61J 1/16  
 206/232  
 2014/0061068 A1 3/2014 Diaz  
 2014/0159405 A1 6/2014 Potter et al.  
 2017/0251790 A1 9/2017 Bedasee  
 2018/0184774 A1 7/2018 Krainz  
 2019/0104831 A1 4/2019 Lazzara  
 2020/0229582 A1 7/2020 Lui et al.  
 2020/0281335 A1 9/2020 Bojaxhi

FOREIGN PATENT DOCUMENTS

EM 0055895040001 S 9/2018  
 EM 0066146400001 S 7/2019  
 EM 006691721-0010 \* 10/2020  
 EM EU0065907330006 10/2020  
 EM EU0066917210002 10/2020  
 EM EU0066917210008 10/2020  
 EM EU0066917210012 10/2020  
 EM EU0065907330003 11/2020  
 FR 20142878001 11/2014  
 WO WO-D046568 S 2/1999

OTHER PUBLICATIONS

Ashlin Designer Trapani Triple Pen Case, unknown first availability date, ashlinleather.com [online], [site visited Jan. 13, 2021], Available at internet URL: <https://ashlinleather.com/ashlin-designer-trapani-triple-pen-case-tuscany-cowhide-pen07-18/> (Year: 2021).\*  
 "15 Pack Ego Silicone Sucker Stand Base Holder for Vapor Tanks and Batter Vaporizer Pens", first available Feb. 28, 2014, site visited Jan. 12, 2021, retrieved from <https://www.amazon.com/Ego-Vaporizer-Electronic-Cigarette-Cigarette/dp/B00KYZBPGY>, 2014, 8 pages.

(56)

**References Cited**

## OTHER PUBLICATIONS

951. Sterling Silver “Envelope” Cigarette Case, dated 1946, Auction Date Mar. 4, 2006, [aspireauctions.com](https://www.aspireauctions.com/) [online], [site visited Jan. 13, 2021], Available at internet URL: <https://www.aspireauctions.com/#!/catalog/61/345/lot/12652>, 1946, 1 page.

“Ashlin® Designer | L’Aquila Double Pen Case”, available as early as Feb. 12, 2019, site visited Jan. 14, 2021, Internet URL exceeds character limit of PTO-892, see written Office Action, dated 2019, 6 pages.

Elegant Red Suede Female Solid Women Evening Bags, unknown first available date, [aliexpress.com](https://www.aliexpress.com/), site visited Jan. 13, 2021, available at internet URL: <https://www.aliexpress.com/i/32977673973.html>, 2021, 4 pgs.

“Genuine Leather Pen Case Holder Fountain Multi Pens Pouch Pen Protective Sleeve Cover: Office Products”, available Mar. 2, 2018, [amazon.com](https://www.amazon.com/) [online], [site visited Jan. 14, 2021], Internet URL exceeds character limit of PTO-892, see written Office Action, dated 2018, 9 pages.

“Goson Classic Leather Squeeze Coin Purse Change Holder for Men and Women Pouch size 3.50 in X 3.25 in: Shoes”, first available May 4, 2018, retrieved from <https://www.amazon.com/Goson-Ciassic-Leather-Squeeze-change/dp/B07CVN6DQ2> on 2018, 12 pages.

“Hide & Drink Leather Vape Pen Case & Nightstand Holder (2 Pieces)”, site visited Jan. 14, 2021, retrieved from <https://www.amazon.com/Hide-Drink-Nightstand-Prevents-Protector/dp/B07QDV25VP>, on Apr. 9, 2019, 7 pages.

“Lucky Line Assorted Squeeze Coin Holder Key Chain (94101), Office Products”, first available Oct. 16, 2006, retrieved from <https://www.amazon.com/Lucky-Line-Piastic-Holder-94101/dp/B00460W6GG>, on 2006, 8 pages.

“Mini Envelope Wallet | Portland Leather Goods”, unknown first available date, site visited Jan. 12, 2021, retrieved from <https://www.portlandleathergoods.com/products/mini-envelope-wallet?variant=29693133717586>, 2021, 8 pages.

Office Action dated Jun. 18, 2020 for Russian Application No. 2019505801, 10 pages.

Office Action dated Jun. 18, 2020 for Russian Application No. 2019505804, 10 pages.

Office Action dated Jun. 18, 2020 for Russian Application No. 2019505805, 10 pages.

Office Action dated Jun. 18, 2020 for Russian Application No. 2019505808, 10 pages.

Office Action dated Jun. 18, 2020 for Russian Application No. 2019505809, 10 pages.

“Tip Vapor Charging Case for JUUL Kit—Vape Juice Depot”, unknown first available date, site visited Jan. 12, 2021, retrieved from <https://vapejuicedepot.com/products/coco-vapor-charging-case-for-juul>, 2021, 7 pages.

“Vype e-cigarette Sleeve”, unknown first available date, site visited Jan. 14, 2021, retrieved from <https://www.govype.ch/vype-e-cigarette-sleeve.html>, 2021, 4 pages.

“Women’s RFID Blocking Small Compact Bifold Leather Pocket Wallet Ladies Mini Purse(2-Envelope Black): Clothing”, first available Sep. 5, 2018, retrieved from [https://www.amazon.com/gp/product/B07GPZMGZ6/ref=as\\_li\\_ss\\_il?ie=UTF8&linkCode=li3&tag=simplicity0e0-20linkId=8584d6a0621d4fe9e5e4cfbd821c3126&language=en\\_US](https://www.amazon.com/gp/product/B07GPZMGZ6/ref=as_li_ss_il?ie=UTF8&linkCode=li3&tag=simplicity0e0-20linkId=8584d6a0621d4fe9e5e4cfbd821c3126&language=en_US), 2018,

8 pages.

Design U.S. Appl. No. 29/718,101, filed Dec. 20, 2019, inventor Cruice et al.

Design U.S. Appl. No. 29/718,104, filed Dec. 20, 2019, inventor Cruice et al.

Design U.S. Appl. No. 29/718,097, filed Dec. 20, 2019, inventor Cruice et al.

Design U.S. Appl. No. 29/718,106, filed Dec. 20, 2019, inventor Cruice et al.

Design U.S. Appl. No. 29/718,114, filed Dec. 20, 2019, inventor Cruice et al.

\* cited by examiner

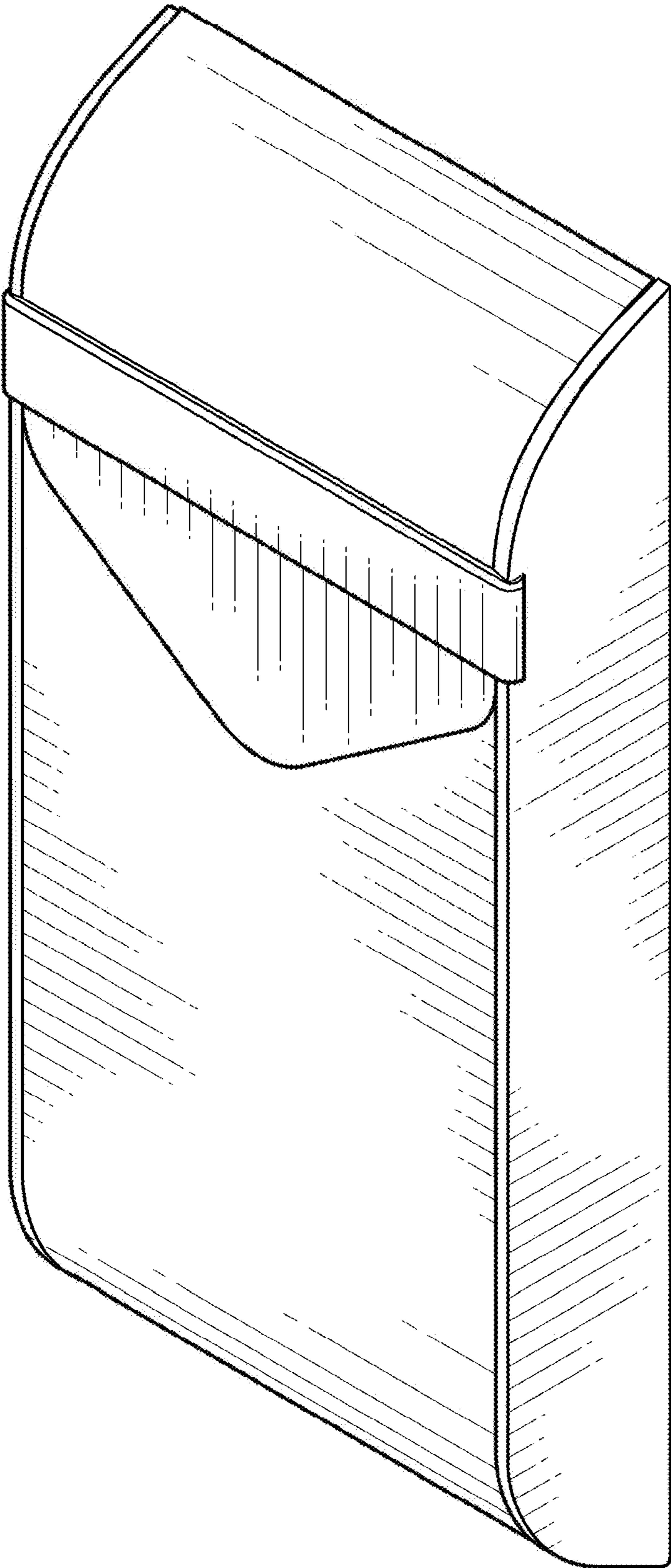

**FIG . 1**

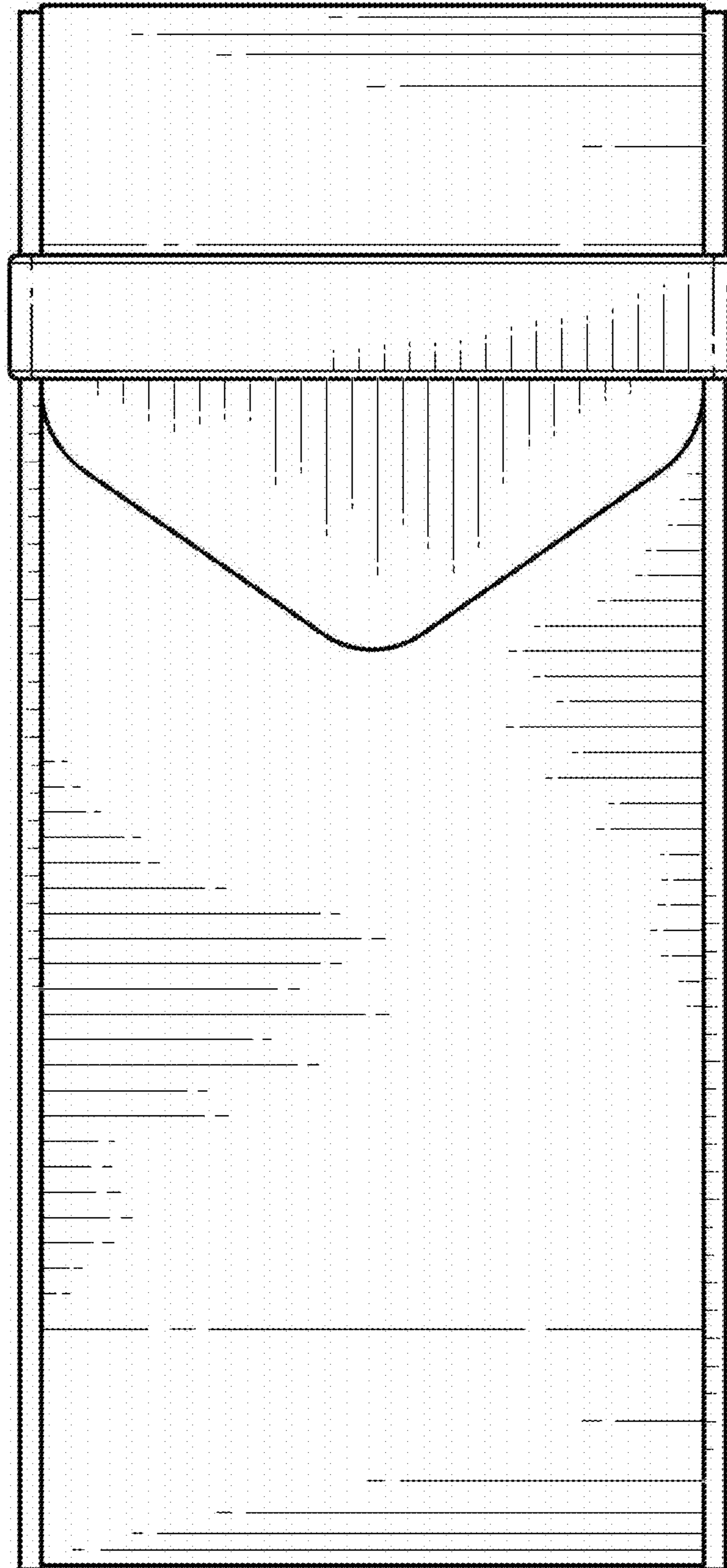
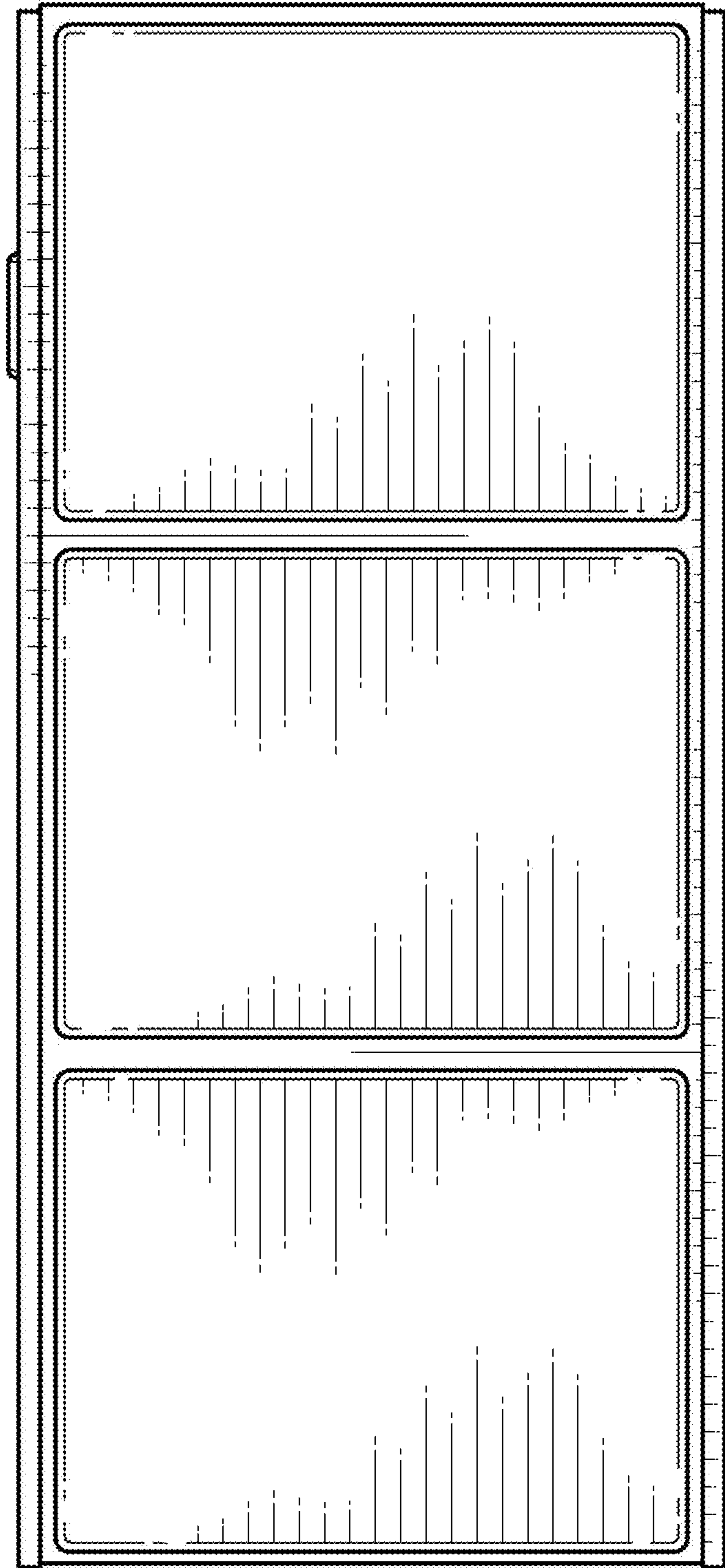

FIG . 2



*FIG . 3*

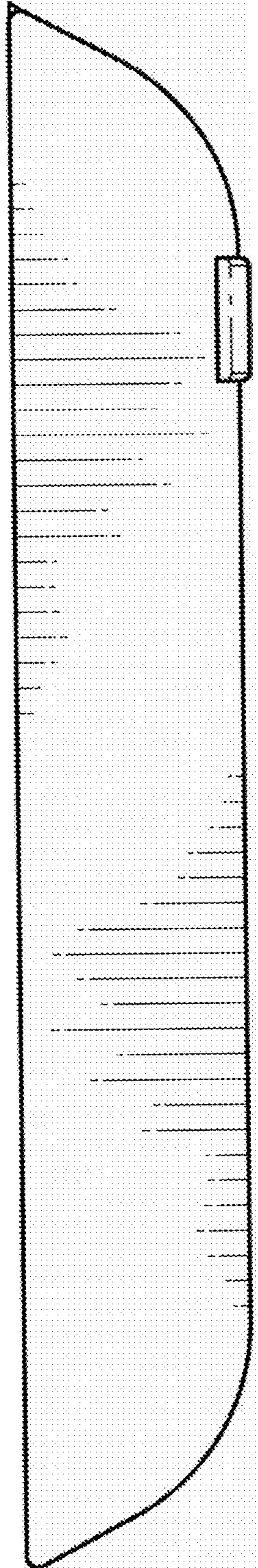

FIG. 4

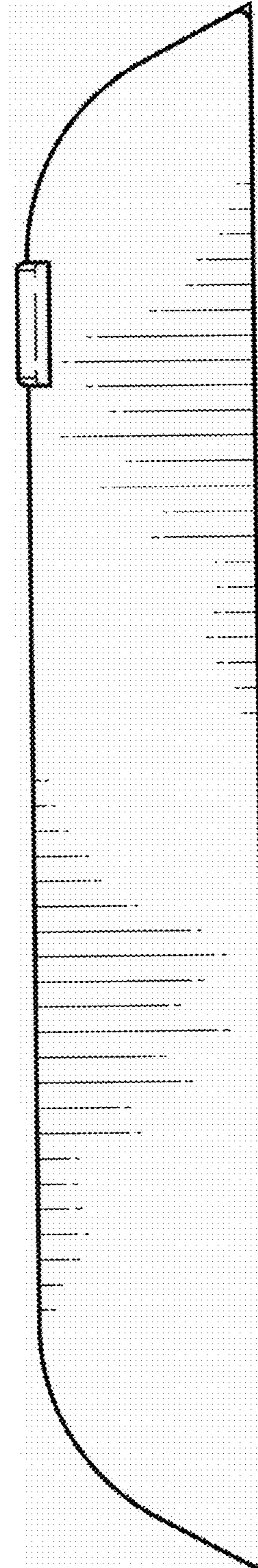

FIG. 5

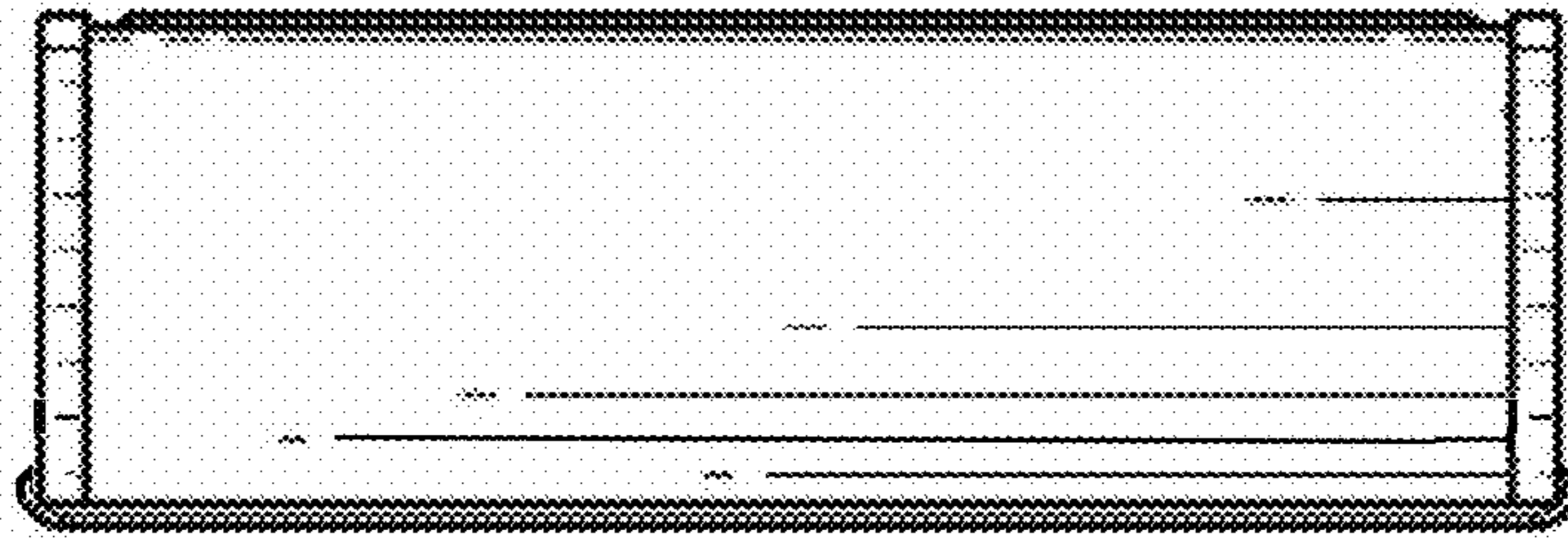

FIG . 6



FIG . 7