



US00D937531S

(12) **United States Design Patent** (10) **Patent No.:** **US D937,531 S**  
**van Eyk et al.** (45) **Date of Patent:** **\*\* Dec. 7, 2021**

(54) **MEAT WRAPPED PET TREAT**

(71) Applicant: **Spectrum Brands, Inc.**, Middleton, WI (US)  
(72) Inventors: **Gregory van Eyk**, Christiansburg, VA (US); **Tiffany Potter**, Pearisburg, VA (US); **Kelli Strazar**, St. Charles, MO (US)  
(73) Assignee: **Spectrum Brands, Inc.**, Middleton, WI (US)

(\*\*) Term: **15 Years**

(21) Appl. No.: **29/701,815**

(22) Filed: **Aug. 14, 2019**

(51) **LOC (13) Cl.** ..... **01-01**

(52) **U.S. Cl.**  
USPC ..... **D1/101**

(58) **Field of Classification Search**  
USPC ..... D1/100-130, 199; 426/2, 89, 92, 104, 426/635, 805, 132, 138, 502, 607, 283; D6/610; D29/120.1, 121.1; D24/189, D24/190, 192, 206; 602/21; D3/218, D3/226, 269; D21/440, 712; 182/882  
(Continued)

(56) **References Cited**

**U.S. PATENT DOCUMENTS**

2,667,711 A \* 2/1954 Anderson ..... B42D 15/02  
206/493  
4,247,567 A \* 1/1981 Momiyama ..... A21D 13/04  
426/302

(Continued)

**FOREIGN PATENT DOCUMENTS**

CN 200630106636.0 1/2007  
CN 200730083519.1 3/2009

(Continued)

**OTHER PUBLICATIONS**

Office Action dated May 18, 2020 from Chinese Patent Application for Design No. 202030051808.9.

(Continued)

*Primary Examiner* — Katie Jane Stofko

(74) *Attorney, Agent, or Firm* — Merchant & Gould P.C.

(57) **CLAIM**

The ornamental design for a meat wrapped pet treat, as shown and described.

**DESCRIPTION**

FIG. 1 is a perspective view of a first embodiment of a meat wrapped pet treat; FIG. 2 is a left side elevation view thereof; FIG. 3 is a right side elevation view thereof; FIG. 4 is a front elevation view thereof; FIG. 5 is a back elevation view thereof; FIG. 6 is a top plan view thereof; FIG. 7 is a bottom plan view thereof; FIG. 8 is a perspective view of a second embodiment of a meat wrapped pet treat; FIG. 9 is a left side elevation view thereof; FIG. 10 is a right side elevation view thereof; FIG. 11 is a front elevation view thereof; FIG. 12 is a back elevation view thereof; FIG. 13 is a top plan view thereof; and, FIG. 14 is a bottom plan view thereof.

The stippled shading and the other portions of the design that are not shown with stippled shading represent a contrasting appearance. The break lines shown in the middle portion of the meat wrapped pet treat in FIGS. 8-10, 13 and 14 indicate that the appearance of any portion of the article between the break lines forms no part of the claimed design.

**1 Claim, 8 Drawing Sheets**

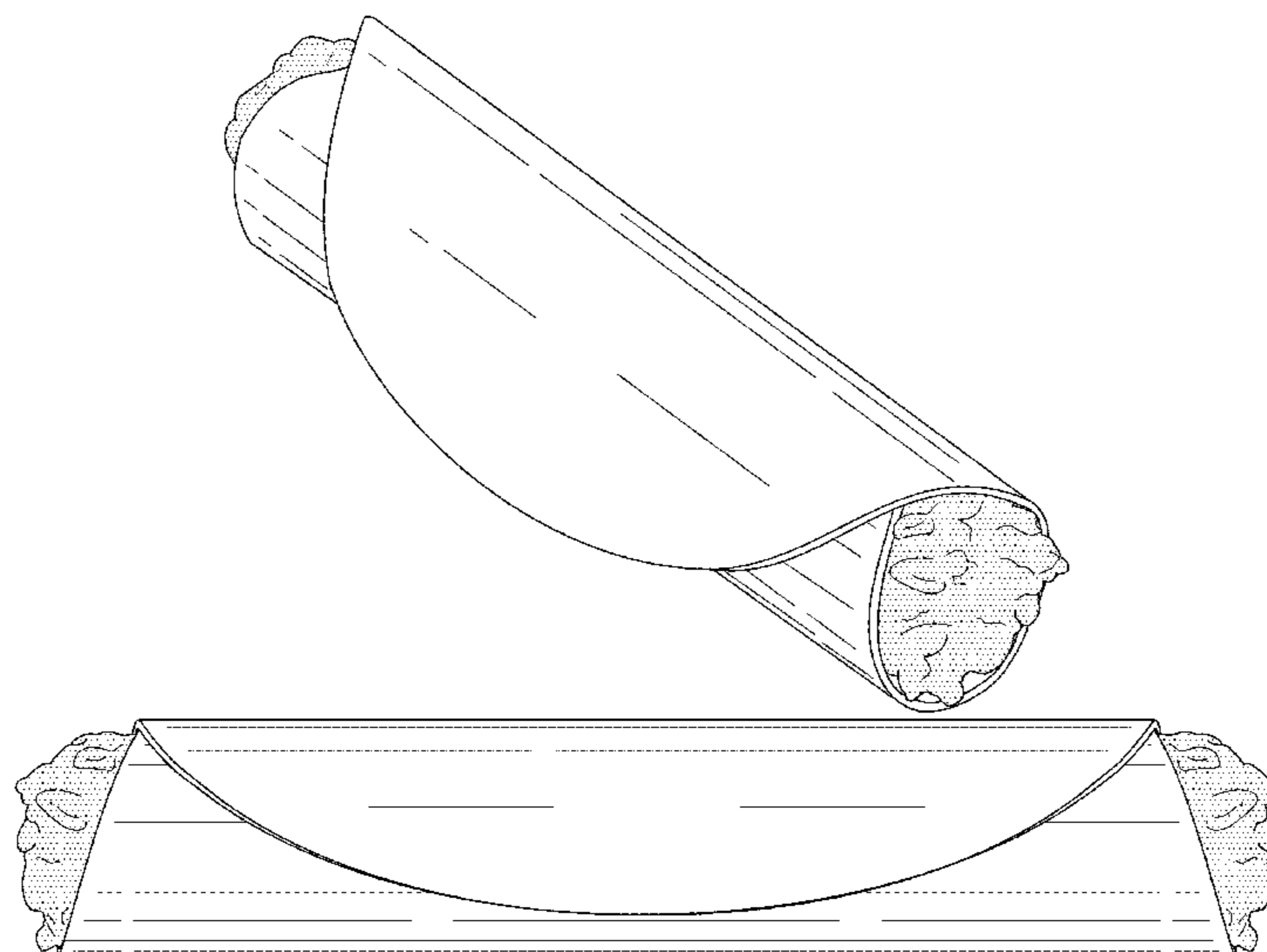

# US D937,531 S

Page 2

## (58) Field of Classification Search

CPC .. E04B 2/7818; E04B 2/82; E04C 3/28; E04F  
2203/04; A23G 3/50; A23G 3/54; A23J  
3/26; A23L 1/0067

2002/0009525 A1\* 1/2002 Janecka ..... A21D 13/32  
426/138  
2004/0091582 A1\* 5/2004 Buriani ..... A23P 20/20  
426/94  
2006/0165849 A1\* 7/2006 Rampersad ..... A21D 13/40  
426/94

See application file for complete search history.

(56)

## References Cited

### U.S. PATENT DOCUMENTS

D297,680 S \* 9/1988 Trojahn ..... D1/101  
4,910,030 A \* 3/1990 Trojahn ..... A23G 9/24  
426/101  
D385,686 S \* 11/1997 Parker ..... D1/122  
D418,753 S \* 1/2000 DuBow ..... D9/434  
D429,053 S \* 8/2000 Barkett ..... D1/101  
D452,359 S \* 12/2001 Terzoli ..... D1/101  
D453,591 S \* 2/2002 Garden ..... D29/120.1  
D557,876 S \* 12/2007 Lenell ..... D1/101  
D645,638 S 9/2011 Mingyun et al.  
D805,720 S 12/2017 Rubio Lamas et al.  
D805,721 S 12/2017 Rubio Lamas et al.  
D805,722 S 12/2017 Rubio Lamas et al.  
D805,723 S 12/2017 Rubio Lamas et al.  
D805,724 S 12/2017 Rubio Lamas et al.  
D821,685 S 7/2018 Rubio Lamas et al.

### FOREIGN PATENT DOCUMENTS

CN 200730083512.X 4/2009  
CN 200830140079.3 6/2009  
CN 201130449386.1 6/2012  
CN 201230001622.8 6/2012  
CN 201230001623.2 6/2012  
CN 201230001627.0 6/2012  
CN 201230001936.8 7/2012  
CN 201230002003.0 7/2012  
CN 201230002941.0 7/2012  
CN 201330466566.X 4/2014  
CN 201830006407.4 7/2018  
CN 201830679774.0 5/2019  
CN 201830720571.1 10/2019  
EM 007757869-0003 4/2020

### OTHER PUBLICATIONS

Office Action dated Jun. 15, 2021 from Vietnamese Patent Appli-  
cation for Design No. 3-2020-00343 (in Vietnamese and English).  
Website entitled "Tortilla (part 2): delicious round, distorted also,"  
<http://soi.today/?p=188137&paged=4>, 14 pages (Oct. 17, 2015).

\* cited by examiner

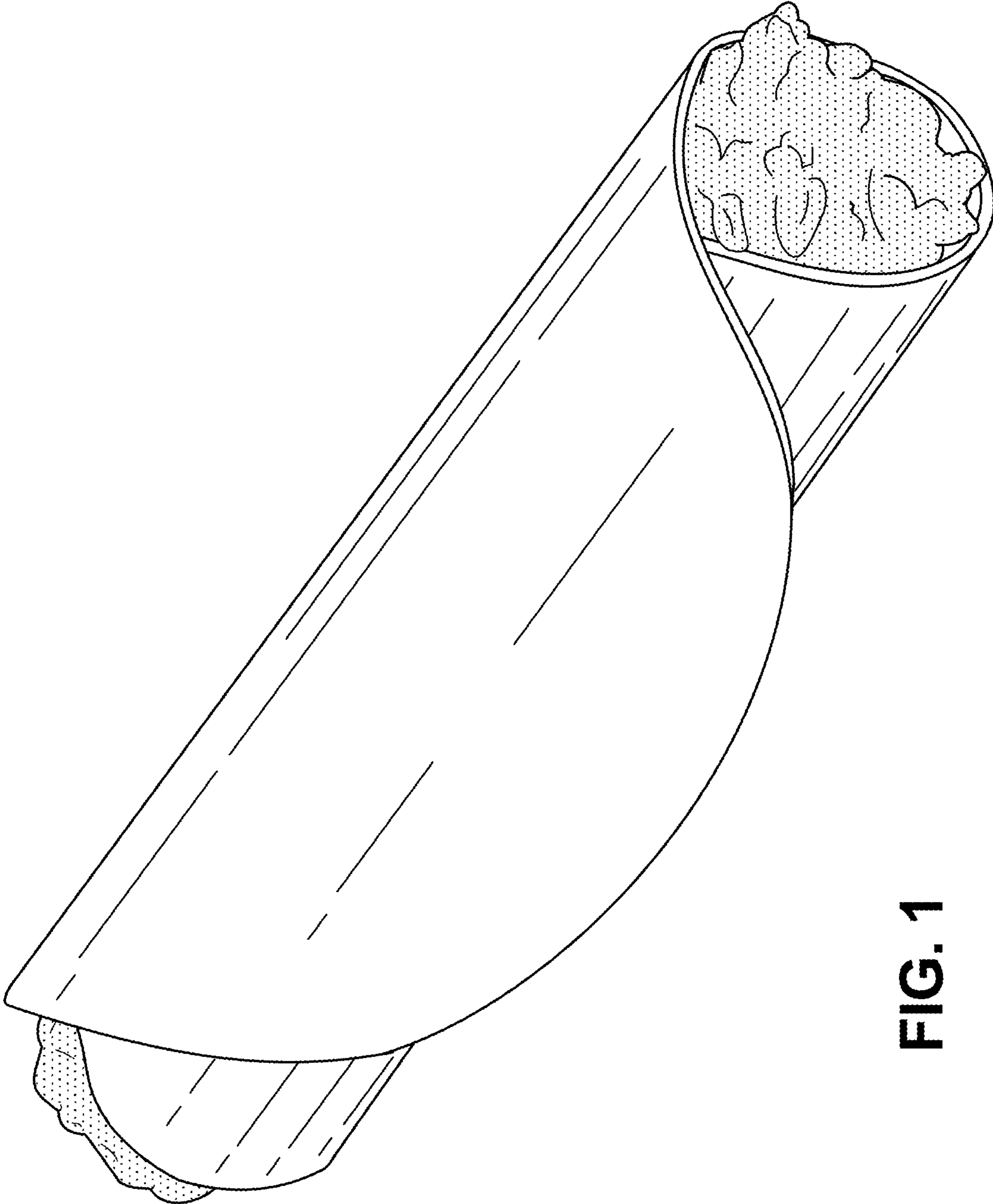

FIG. 1

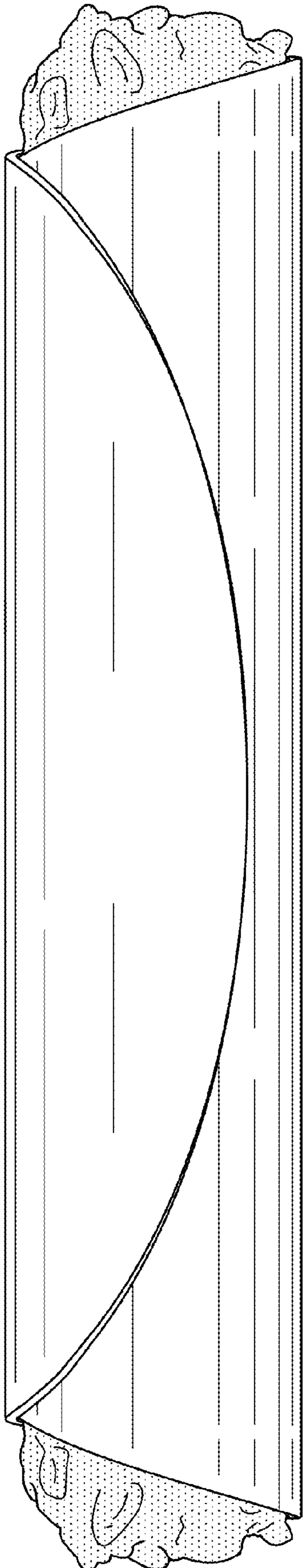

FIG. 2

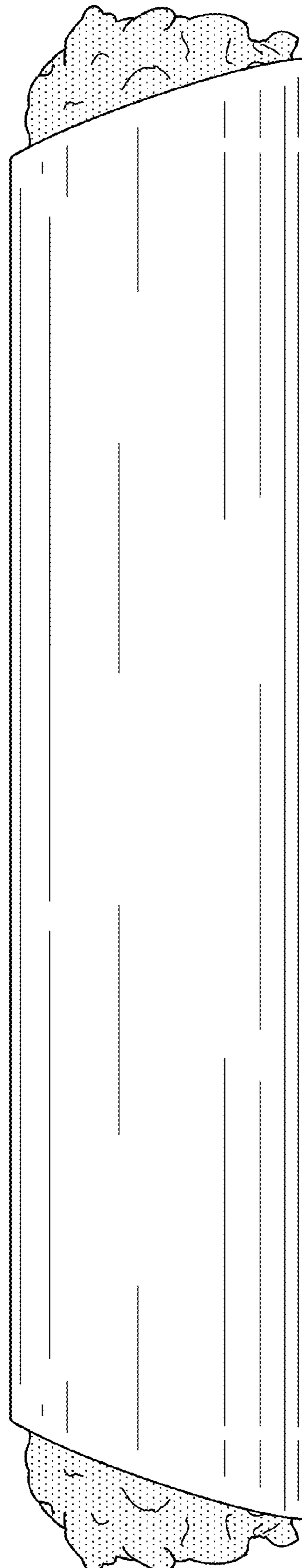
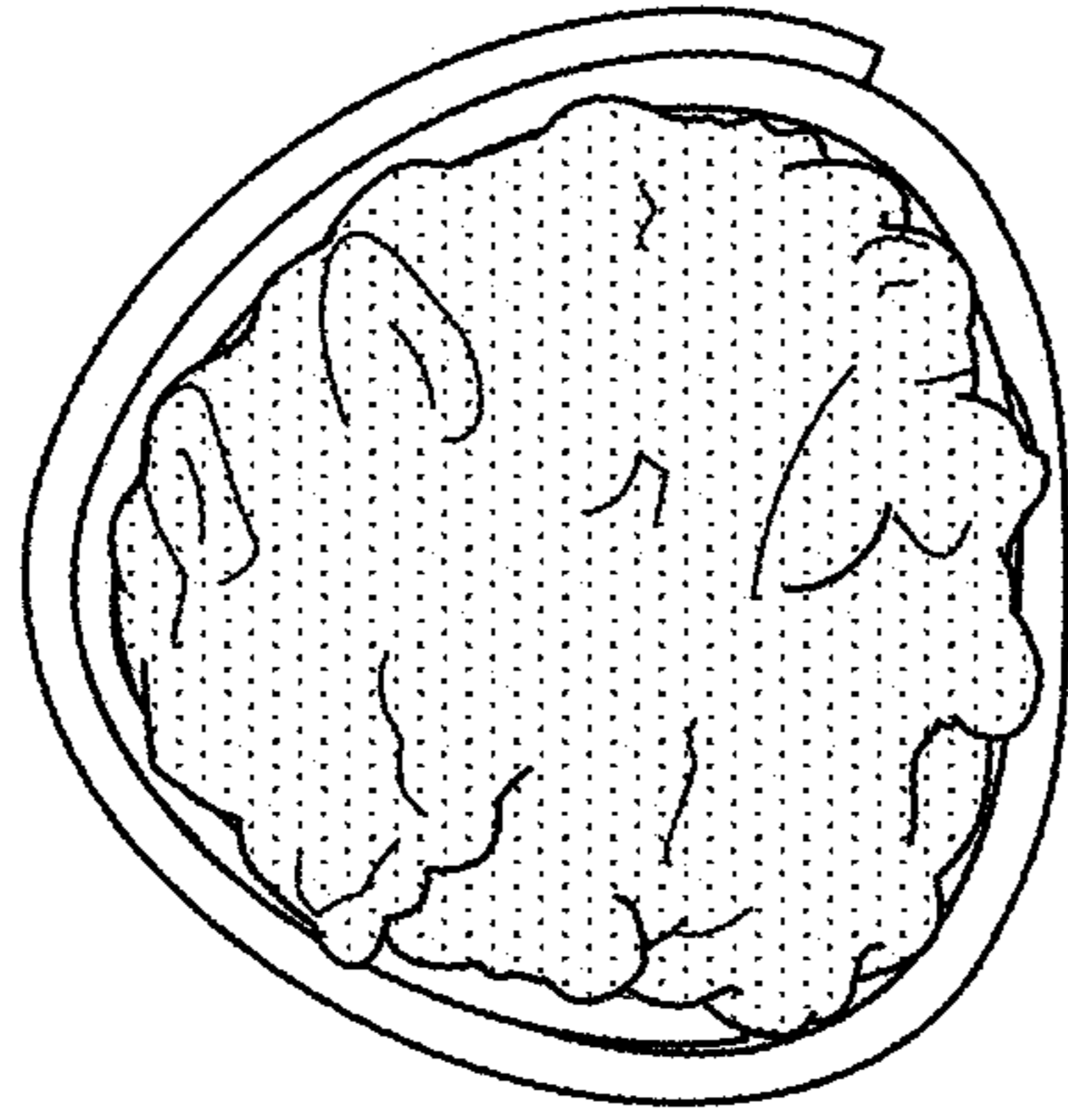
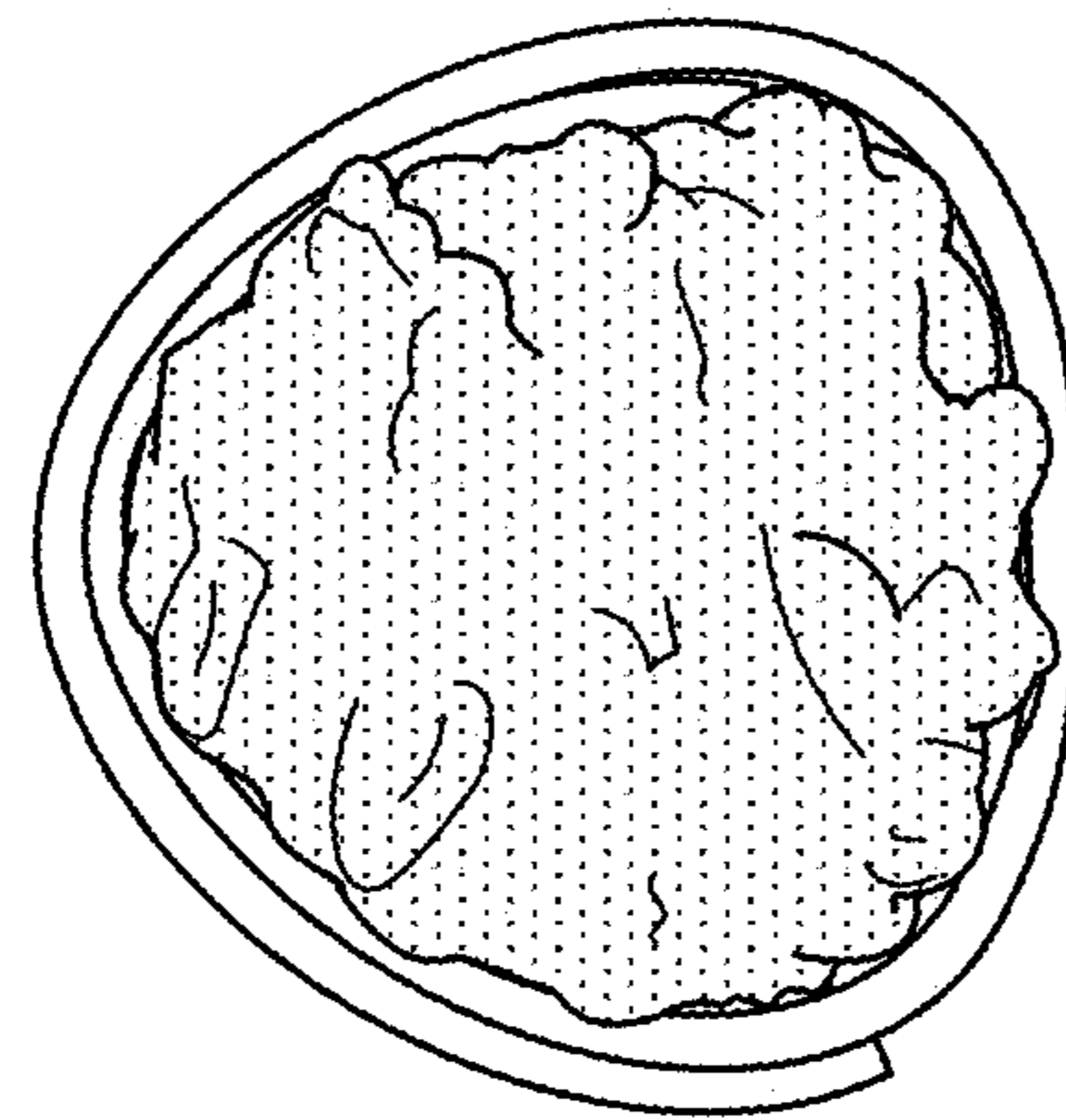

FIG. 3





**FIG. 4**



**FIG. 5**

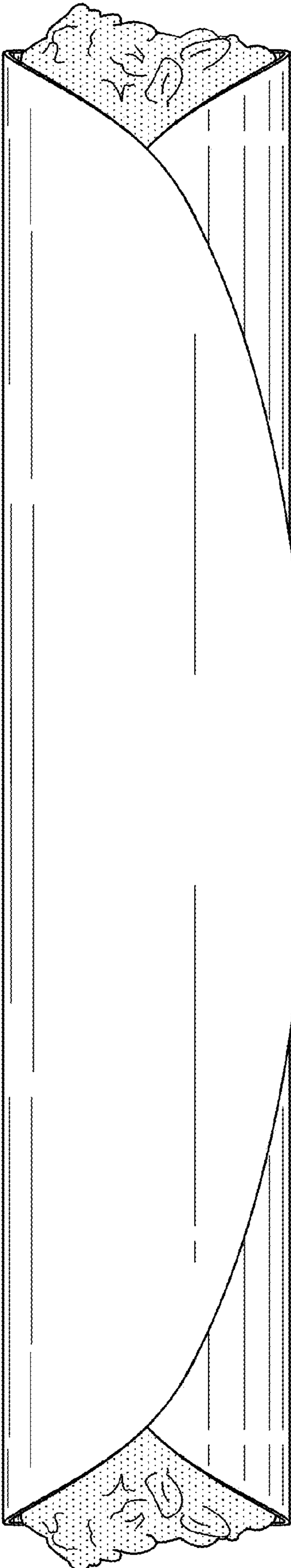

FIG. 6

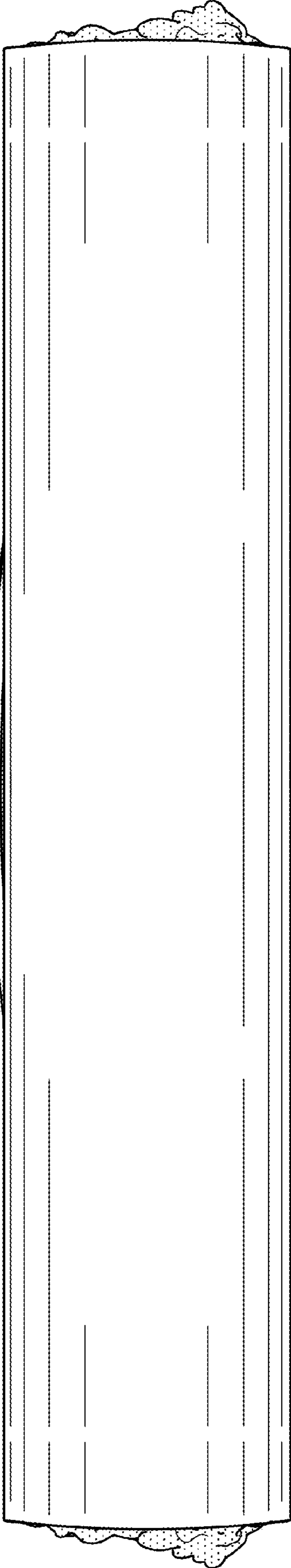

FIG. 7

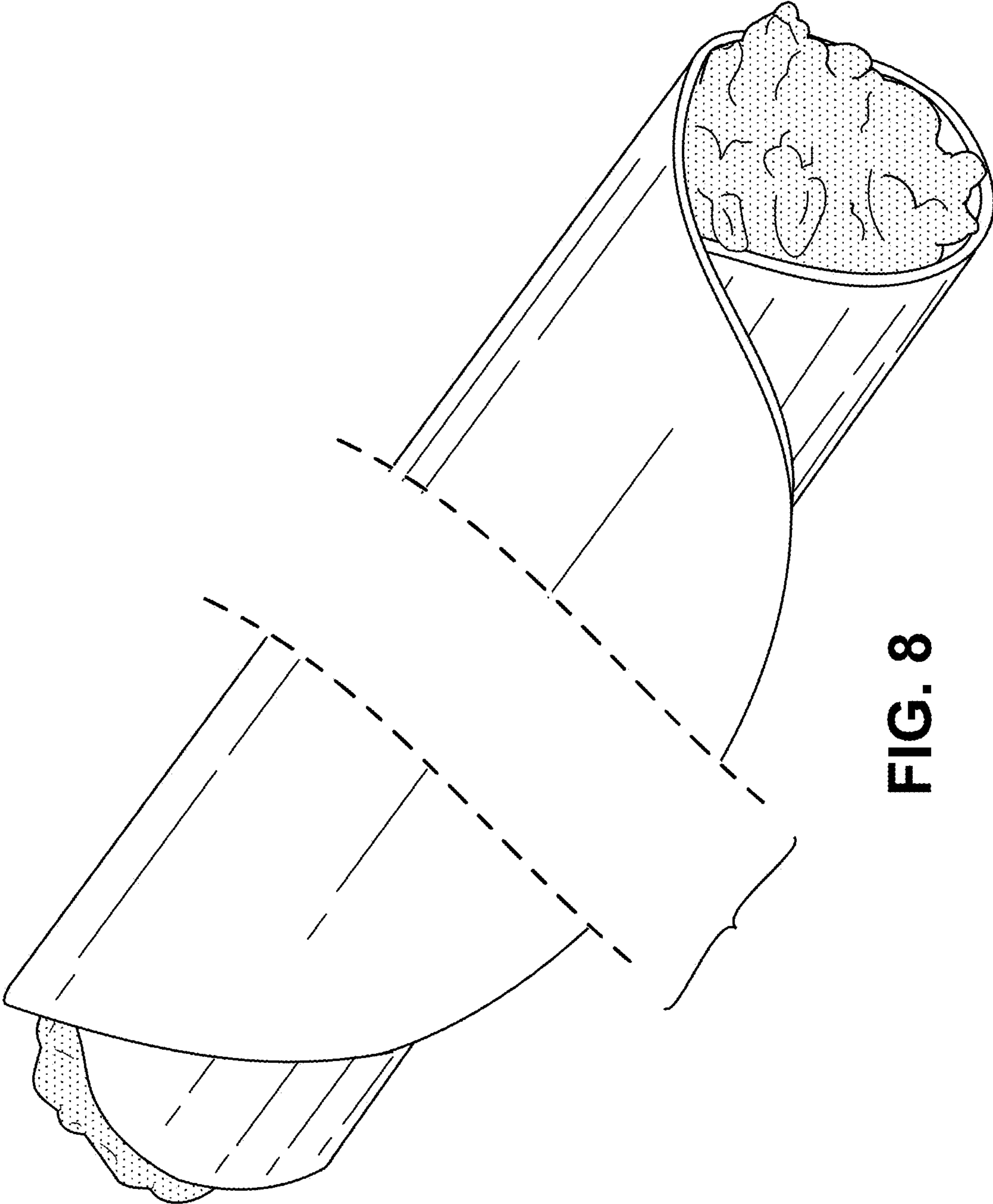

FIG. 8

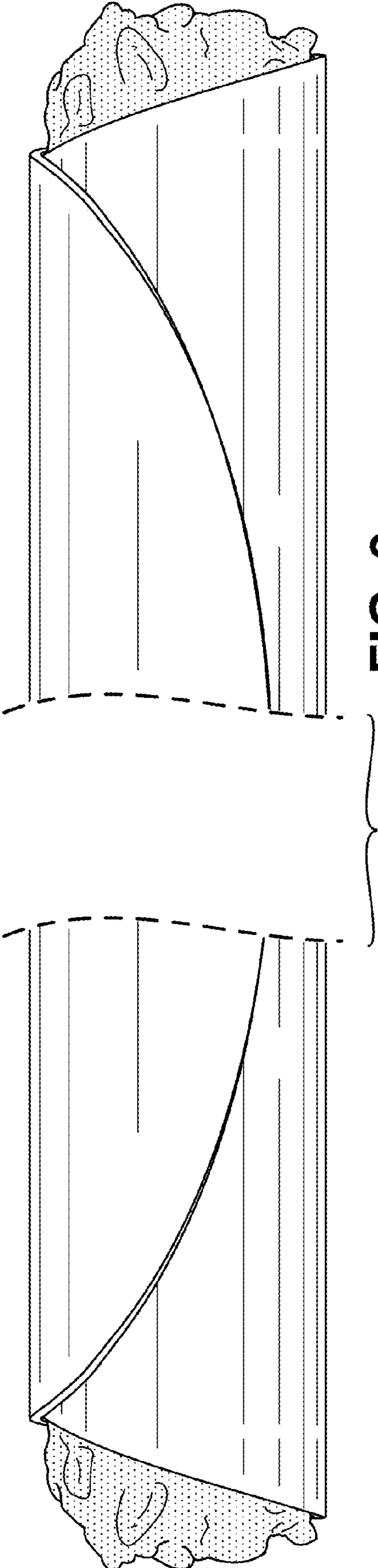

FIG. 9

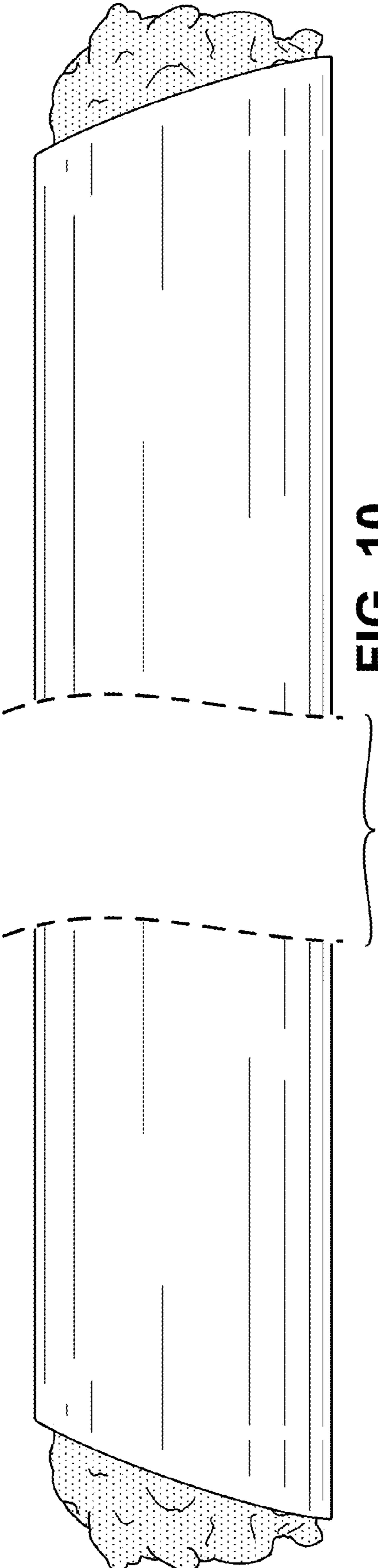

FIG. 10



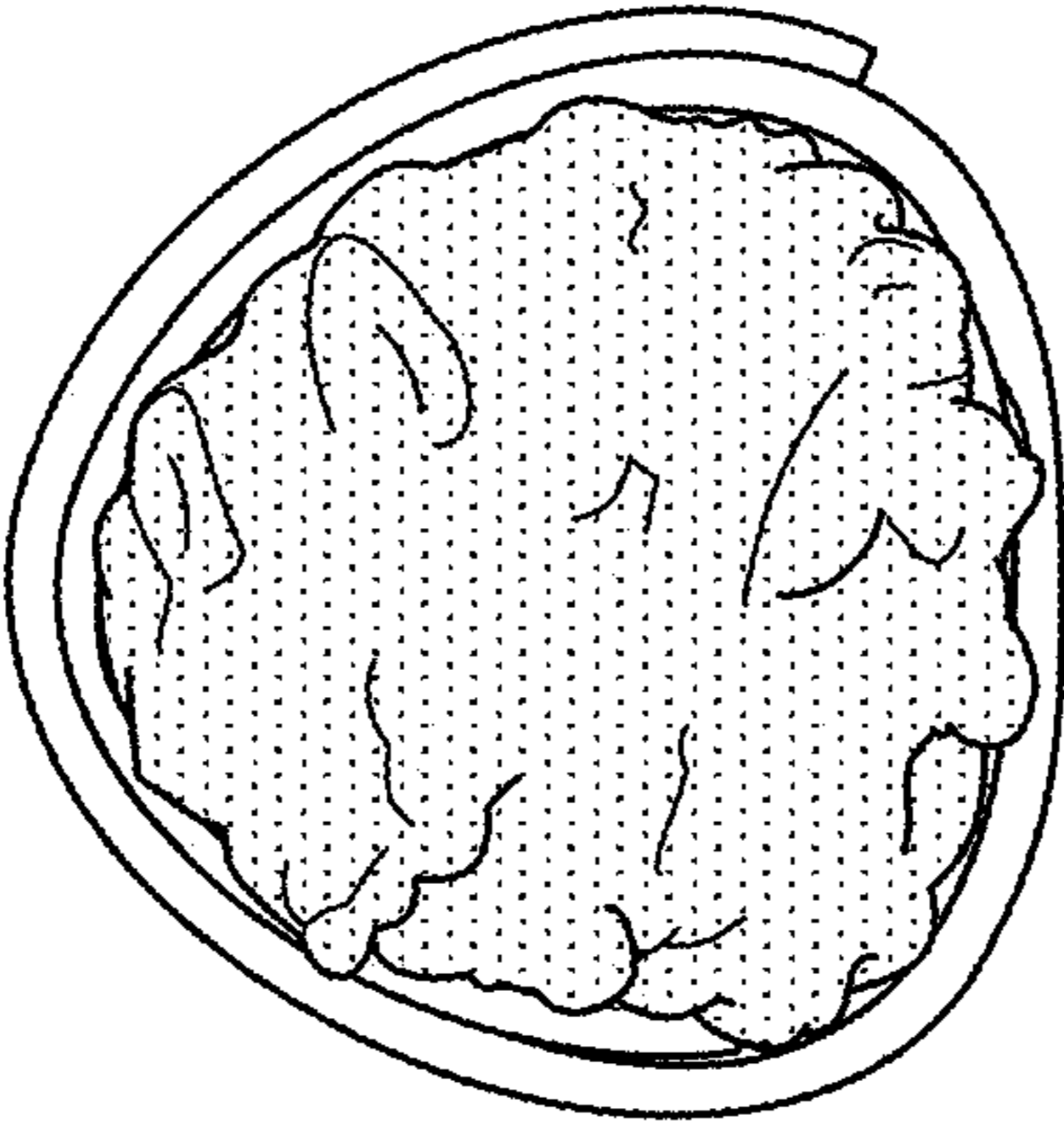

FIG. 11

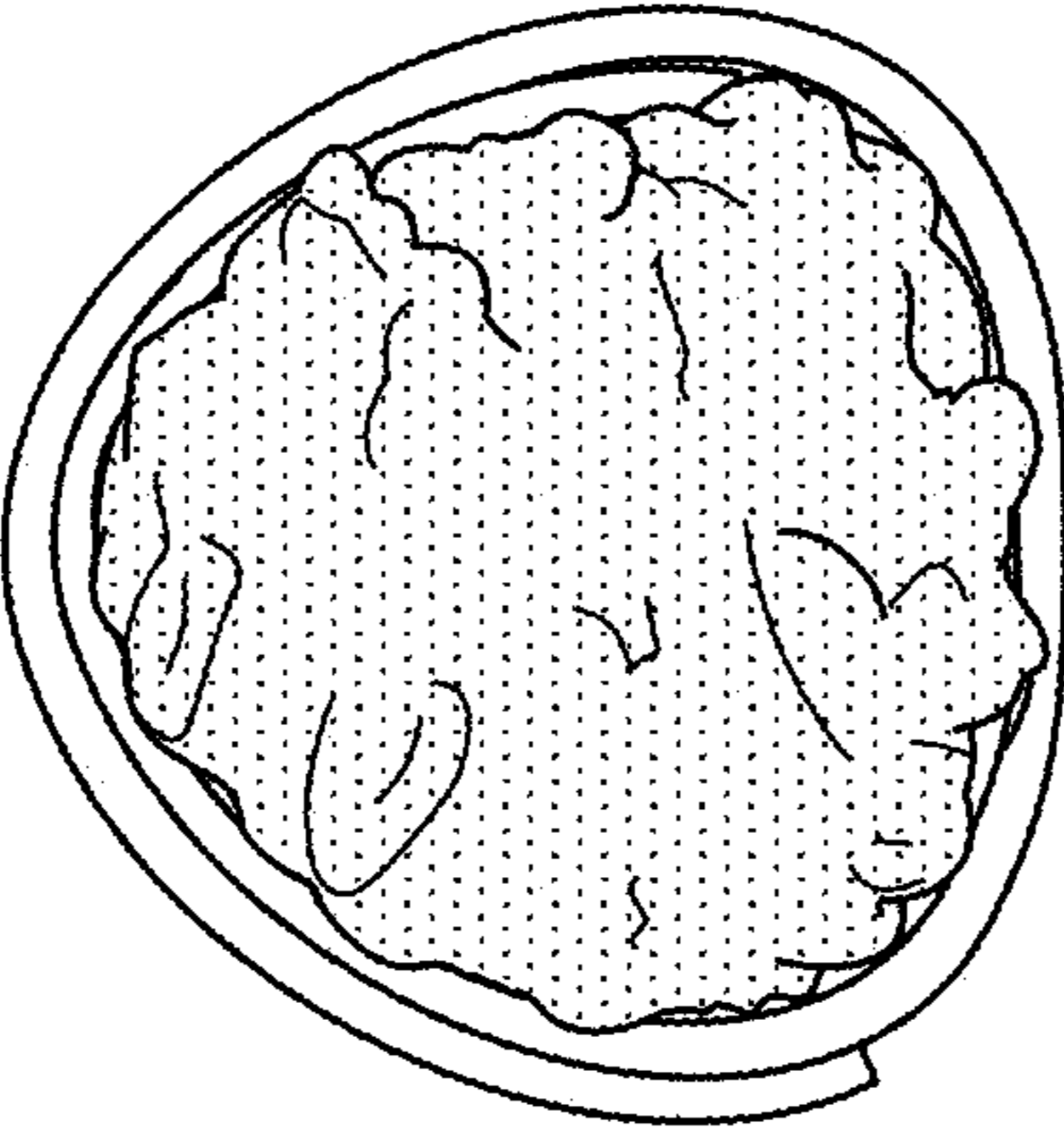

FIG. 12

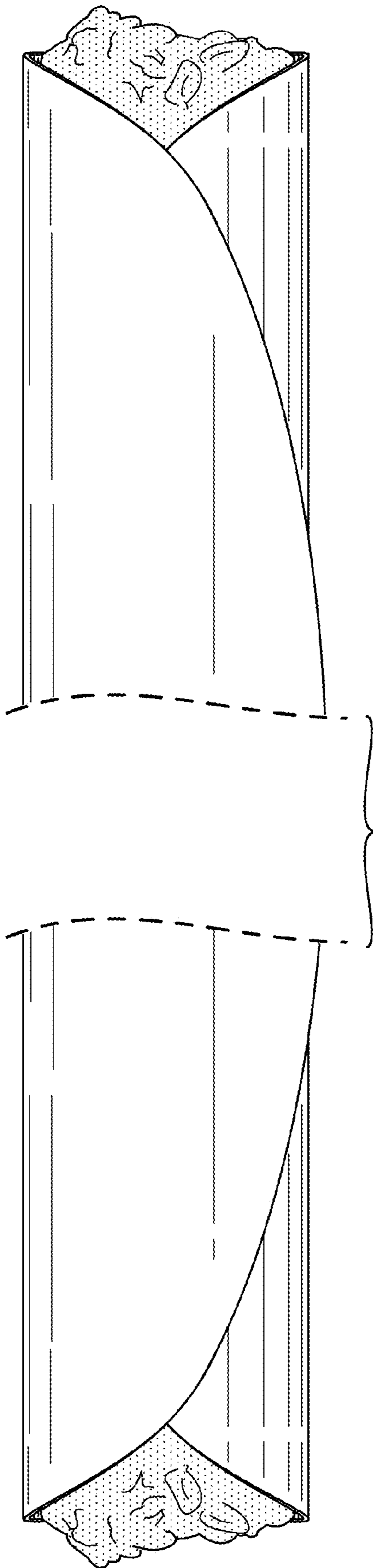

FIG. 13

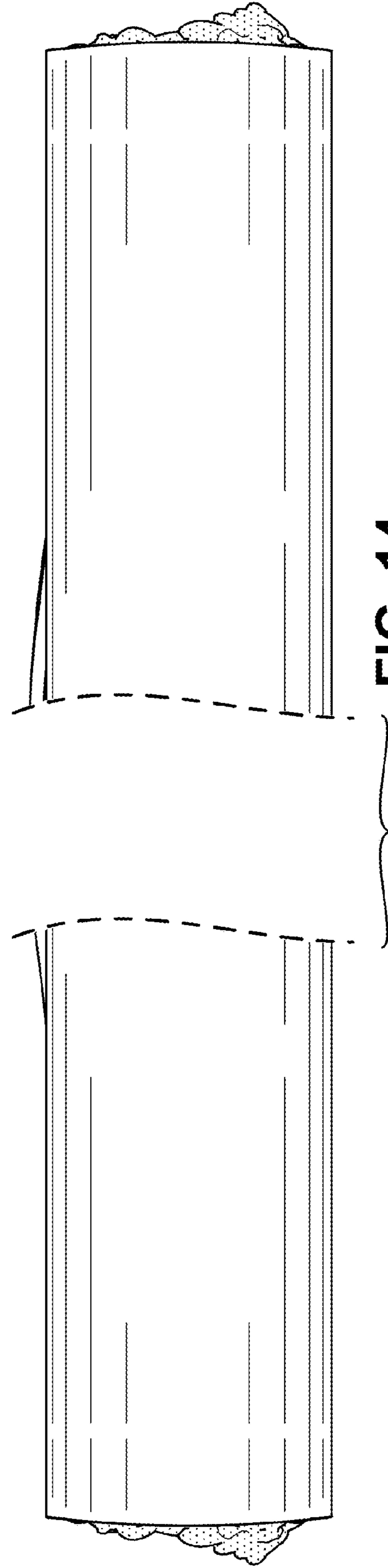

FIG. 14