



US00D937499S

(12) **United States Design Patent**
Paucar

(10) **Patent No.:** **US D937,499 S**

(45) **Date of Patent:** **** Nov. 30, 2021**

(54) **SLOW-CONSUME ANIMAL FEEDING
COUPLING ROUND INSERT**

(71) Applicant: **R.M. INNOVATION LLC**, Corland,
OH (US)

(72) Inventor: **Raina Marie Paucar**, Corland, OH
(US)

(**) Term: **15 Years**

(21) Appl. No.: **29/725,982**

(22) Filed: **Feb. 28, 2020**

(51) **LOC (13) Cl.** **30-07**

(52) **U.S. Cl.**
USPC **D30/121; D30/199**

(58) **Field of Classification Search**

USPC D30/121, 122, 128-133, 199, 160, 155,
D30/118; 119/61.5, 51.01, 61.56, 51.03,
119/59, 62, 63, 51.5, 57.8, 74, 61.54,
119/61.55, 712, 174, 215, 52.1, 53, 53.5,
119/75, 51.02, 52.3, 57.9, 77, 707, 711;
604/61-63; 221/270, 268; D8/1;
220/23.87, 630, 737, 743, 9.4, 495.01,
220/574, 212, 255, 23.83, 573.4, 574.3,
220/769; D23/213, 214, 233; 47/79,
47/48.5, 40.5, 44, 47, 39, 45; 239/280,
239/530, 532, 569, 556; D7/700, 398;
141/331, 345, 333, 334, 337, 391;
138/155; D11/143, 144, 152, 127, 121,
D11/125; 222/400.7; 137/322; 473/560;
273/129 R, 144 R, 447; 294/54.5, 55,
(Continued)

(56) **References Cited**

U.S. PATENT DOCUMENTS

75,673 A * 3/1868 Gibson A47J 37/10
99/425
472,316 A * 4/1892 Smith A01K 5/0114
119/61.1

(Continued)

OTHER PUBLICATIONS

Feeding Choke-Prone Horses, Kristen M. Janicki, MS, PAS, Sep.
24, 2018, 5 pages, internet.

(Continued)

Primary Examiner — Susan Moon Lee

(74) *Attorney, Agent, or Firm* — Loomis, Ewert, Parsley,
Davis & Gotting P.C.; Mikhail Murshak

(57) **CLAIM**

The ornamental design for a slow-consume animal feeding
coupling round insert, as shown and described.

DESCRIPTION

FIG. 1 is a perspective view of an animal feeding coupling
round insert in accordance with the present invention;
FIG. 2 is a top view of the animal feeding coupling round
insert of FIG. 1;
FIG. 3 is a front-side view of the animal feeding coupling
round insert of FIG. 1;
FIG. 4 is a rear-side view of the animal feeding coupling
round insert of FIG. 1;
FIG. 5 is a right-side view of the animal feeding coupling
round insert of FIG. 1;
FIG. 6 is a left-side view of the animal feeding coupling
round insert of FIG. 1;
FIG. 7 is a bottom view of the animal feeding coupling
round insert of FIG. 1; and,
FIG. 8 is a perspective exploded view of the animal feeding
coupling round insert of FIG. 1 to fit in a feeding bowl
shown in broken lines.

The broken lines shown in the Figures are for environmental
purposes only and form no part of the claimed design.

1 Claim, 4 Drawing Sheets

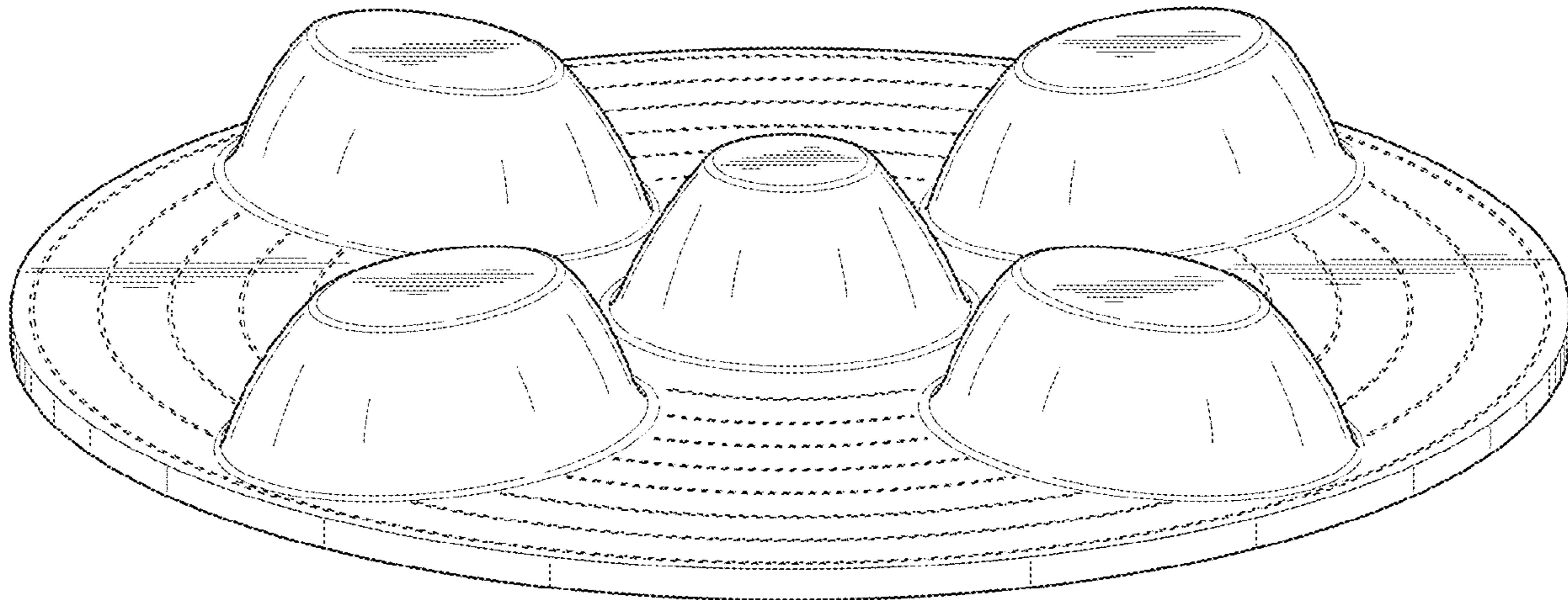

US D937,499 S

(58) Field of Classification Search

USPC 294/1.4, 137, 170; D21/791, 792, 459,
 D21/656, 576, 577, 584, 585, 590, 595,
 D21/362, 363, 350, 360, 334, 347, 338,
 D21/340, 339, 343; 446/241; D34/21,
 D34/24, 26, 17, 23, 12; D5/65, 99;
 D10/104; D13/168
 CPC A01K 5/0114; A01K 5/00; A01K 5/01;
 A01K 5/0107; A01K 5/0291; A01K
 5/0135; A01K 7/00; A01K 7/005; A01K
 1/0107; A01K 1/0157; F16N 31/002;
 F16N 31/004; F16N 31/006

See application file for complete search history.

(56) References Cited

U.S. PATENT DOCUMENTS

495,872 A * 4/1893 Ball A21B 3/13
 249/117
 1,002,509 A * 9/1911 Fitz A61J 19/00
 4/258
 2,554,086 A * 5/1951 Block A01K 5/0135
 119/51.5
 D191,058 S * 8/1961 Jones D7/584
 D221,099 S * 7/1971 Alparone D7/584
 3,683,938 A * 8/1972 Rowland A24F 19/0028
 131/240.1
 3,838,772 A * 10/1974 Lang B65D 21/0233
 206/520
 3,883,037 A * 5/1975 Seiller A47F 7/021
 206/5
 3,958,504 A * 5/1976 Levin A47J 36/022
 99/426
 D246,627 S * 12/1977 Sugiyama D7/359
 4,085,706 A * 4/1978 Evans A01K 5/0114
 119/61.54
 4,127,189 A * 11/1978 Shumrak B65D 1/34
 206/520
 D267,221 S * 12/1982 Williams 426/523
 D274,781 S * 7/1984 Baker D7/359
 4,464,405 A * 8/1984 De Christopher A21B 3/13
 425/395
 D283,496 S * 4/1986 Pisarkiewicz D11/164
 D296,020 S * 5/1988 McCarroll D30/130
 D304,536 S * 11/1989 Blaser D7/584
 5,094,032 A * 3/1992 Byland A01G 9/021
 47/71
 D399,787 S * 10/1998 Wagner D11/164
 D418,367 S * 1/2000 Thomas D7/504
 D477,171 S * 7/2003 Gabbour D6/582
 D485,208 S * 1/2004 Fan D11/143
 D485,784 S * 1/2004 Fan D11/143
 D490,745 S * 6/2004 Fan D11/143
 D531,081 S * 10/2006 Fan D11/143
 7,207,291 B1 * 4/2007 Watts A01K 5/0114
 119/61.5
 D563,608 S * 3/2008 Kitchen A01K 5/0114
 D30/129
 D576,735 S * 9/2008 Strickler D23/261
 D587,970 S * 3/2009 Zack D7/541
 D590,109 S * 4/2009 Anderson D30/129
 D600,861 S * 9/2009 Sin D30/129
 D618,970 S * 7/2010 Quinn D7/669
 7,753,000 B1 * 7/2010 Turner A01K 5/01
 119/61.2
 D623,806 S * 9/2010 Modi D30/129
 7,895,975 B2 * 3/2011 Markham A01K 5/0135
 119/61.5
 D636,944 S * 4/2011 Anderson D30/129
 D645,274 S * 9/2011 Terada D6/682.6
 D648,904 S * 11/2011 Tedaldi A01K 1/0135
 D30/129
 D651,048 S * 12/2011 Gold D7/553.6

8,082,882 B1 * 12/2011 Tharp A01K 5/01
 119/60
 D654,230 S * 2/2012 Tedaldi D30/129
 8,381,684 B2 * 2/2013 Crawford A01K 5/0114
 119/61.5
 D681,886 S * 5/2013 Paschall D30/129
 D682,481 S * 5/2013 Krueger D30/124
 D698,095 S * 1/2014 Paculdo D30/121
 D698,096 S * 1/2014 Paculdo D30/121
 D699,009 S * 2/2014 Hansen D30/121
 D700,407 S * 2/2014 Paschall D30/129
 8,651,055 B2 * 2/2014 Dreger A01K 5/0135
 119/61.5
 D701,732 S * 4/2014 Ehrenhaus D7/539
 D705,999 S * 5/2014 Hansen D30/121
 D706,000 S * 5/2014 Martinez D30/121
 D706,001 S * 5/2014 Hansen D30/121
 D706,493 S * 6/2014 Hansen D30/121
 D706,494 S * 6/2014 Hansen D30/121
 D706,495 S * 6/2014 Hansen D30/121
 D717,006 S * 11/2014 Alfonso D30/129
 8,887,665 B2 * 11/2014 Rocker A01K 5/0114
 119/61.2
 8,899,180 B2 * 12/2014 Lindskov A01K 5/0114
 119/61.1
 8,919,288 B2 * 12/2014 Ressemann A61D 5/00
 119/61.5
 D731,262 S * 6/2015 Zila D7/672
 D731,263 S * 6/2015 Zila D7/672
 D732,421 S * 6/2015 Cordova D11/164
 D741,024 S * 10/2015 Liu D30/129
 RE45,837 E * 1/2016 Krueger D30/124
 D747,131 S * 1/2016 Takayama D7/352
 9,241,777 B2 * 1/2016 Ressemann A01K 13/00
 D762,017 S * 7/2016 Tsengas A01K 5/0114
 D30/129
 9,402,370 B2 * 8/2016 Lindskov A01K 5/0114
 D769,546 S * 10/2016 Hansen D30/121
 9,545,081 B2 * 1/2017 Nolan A01K 15/02
 D782,749 S * 3/2017 Michizoe D30/129
 D800,516 S * 10/2017 Koch D7/667
 D804,237 S * 12/2017 Takayama D7/359
 D819,278 S * 5/2018 Watanabe D30/129
 D830,097 S * 10/2018 Takayama D7/352
 D833,086 S * 11/2018 Hansen D30/121
 10,149,455 B2 * 12/2018 Tharp A01K 5/01
 10,172,323 B2 * 1/2019 Glinsky A01K 5/0275
 D847,222 S * 4/2019 Todirca D15/90
 D852,237 S * 6/2019 Helton D15/90
 D852,854 S * 7/2019 Helton D15/90
 D856,604 S * 8/2019 Peart D30/129
 D857,307 S * 8/2019 Miyawaki D30/129
 D861,995 S * 10/2019 Lentz D30/121
 D874,071 S * 1/2020 Gevaert D30/129
 D882,880 S * 4/2020 Levin D30/121
 D885,687 S * 5/2020 Daymont D30/129
 D895,216 S * 9/2020 Becattini, Jr. D30/129
 D895,906 S * 9/2020 Becattini, Jr. D30/129
 D897,050 S * 9/2020 Wang D30/121
 10,791,710 B1 * 10/2020 White A01K 5/0114
 D901,094 S * 11/2020 White D30/129
 D902,500 S * 11/2020 Glinsky D30/129
 D903,208 S * 11/2020 Hu D30/129
 D903,951 S * 12/2020 Hu D30/129
 D904,695 S * 12/2020 Becattini, Jr. D30/129
 D907,308 S * 1/2021 Becattini, Jr. D30/130
 D908,978 S * 1/2021 Wu D30/130
 D910,932 S * 2/2021 Hu D30/129
 D914,996 S * 3/2021 Xie D30/121
 D915,000 S * 3/2021 Huang D30/130
 D915,686 S * 4/2021 Becattini, Jr. D30/129
 D918,486 S * 5/2021 Becattini, Jr. D30/129
 D918,487 S * 5/2021 Becattini, Jr. D30/129
 D919,194 S * 5/2021 Becattini, Jr. D30/129
 11,071,278 B2 * 7/2021 Bruggink A01K 5/01
 2002/0185073 A1 * 12/2002 Fullerton A01K 15/02
 119/51.01

(56)

References Cited

U.S. PATENT DOCUMENTS

2004/0200845 A1* 10/2004 Watzke B65D 81/32
220/501
2005/0039689 A1* 2/2005 Mossmer A01K 5/0128
119/61.5
2005/0127074 A1* 6/2005 Kusuma B65D 21/086
220/6
2006/0005774 A1* 1/2006 Newman Bornhofen
A01K 5/0135
119/61.5
2006/0213447 A1* 9/2006 Kitchen A01K 5/0114
119/61.5
2008/0053374 A1* 3/2008 Kerrigan A01K 5/0114
119/51.03
2008/0072829 A1* 3/2008 Kerrigan A01K 5/0114
119/61.5
2008/0141945 A1* 6/2008 Markham A01K 5/0114
119/61.5
2009/0025644 A1* 1/2009 Ebert A01K 5/0114
119/61.5
2009/0126641 A1* 5/2009 Anderson A01K 5/0114
119/61.5
2010/0012042 A1* 1/2010 Lee A01K 7/00
119/61.5
2012/0090549 A1* 4/2012 Tharp A01K 5/01
119/51.5
2012/0174874 A1* 7/2012 Ottosson A01K 15/025
119/707

2013/0125823 A1* 5/2013 Simon A01K 5/0114
119/61.5
2013/0129890 A1* 5/2013 Cox A47J 37/01
426/496
2013/0228128 A1* 9/2013 Schehr A01K 5/0135
119/61.5
2014/0060442 A1* 3/2014 Ressemann A01K 13/00
119/61.5
2014/0158054 A1* 6/2014 Clarke A01K 5/00
119/51.01
2015/0068461 A1* 3/2015 Lindskov A01K 5/00
119/51.01
2016/0073805 A1* 3/2016 Laurain A47G 19/10
220/575
2016/0255813 A1* 9/2016 Wolfe, Jr. A01K 5/00
2017/0112092 A1* 4/2017 Simon A01K 5/0114
2017/0112093 A1* 4/2017 Glinsky A01K 5/0291
2017/0348082 A1* 12/2017 Ogleby A01K 15/026
2018/0133991 A1* 5/2018 Tsengas A01K 7/00
2018/0359991 A1* 12/2018 Levin A01K 5/00
2018/0368357 A1* 12/2018 Yang A01K 5/0114
2019/0281788 A1* 9/2019 Becattini, Jr. A01K 5/0114
2019/0380302 A1* 12/2019 Northrop A01K 5/0114

OTHER PUBLICATIONS

Feedsmart Troughs, Gough Plastics, Sep. 3, 2020, 3 pages, internet.
Vacuvita Vacuum Food Storage System Review, The Gadgeteer,
Julie Strietelmeier, May 10, 2017, 26 pages, internet.

* cited by examiner

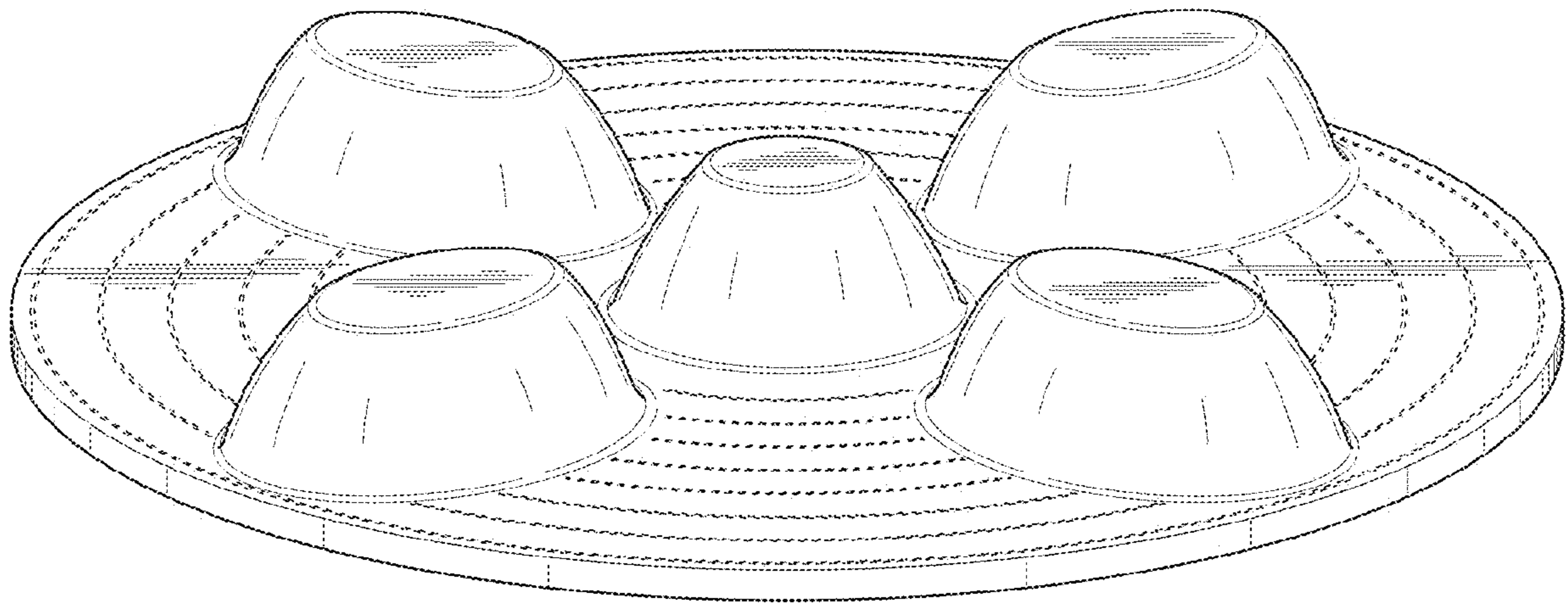

FIG. 1

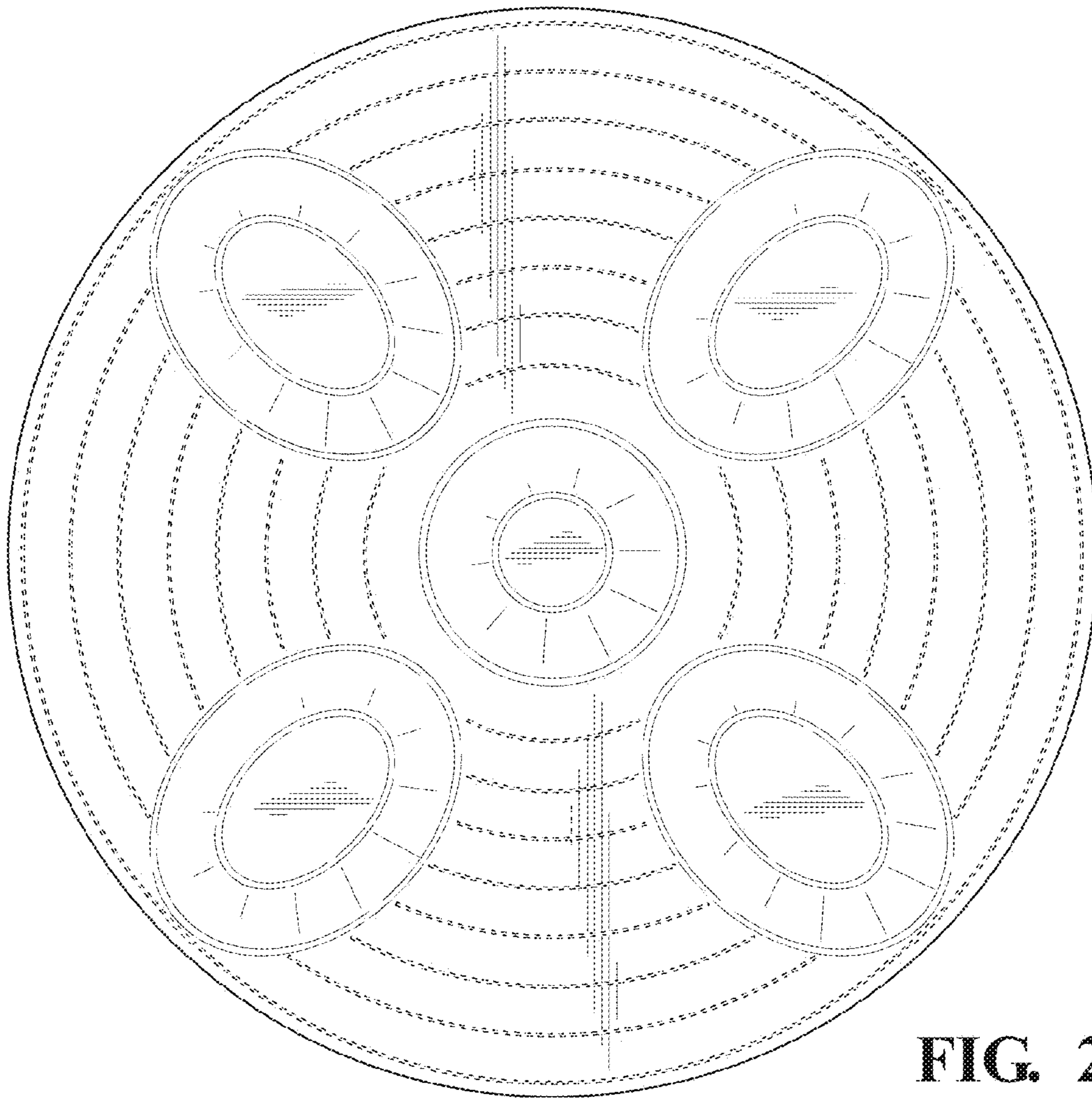

FIG. 2

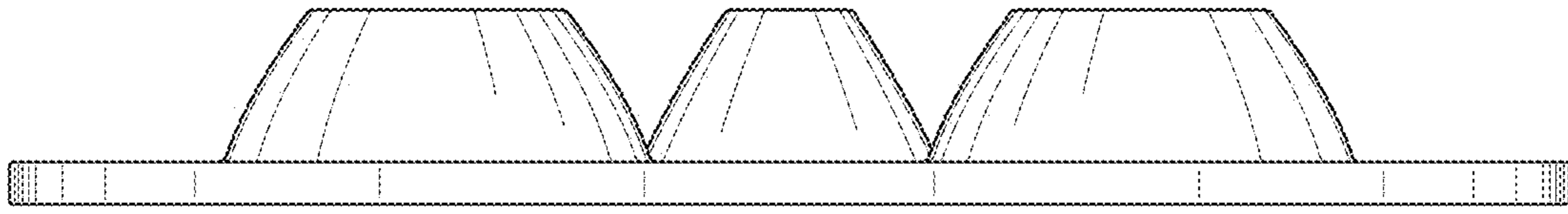

FIG. 3

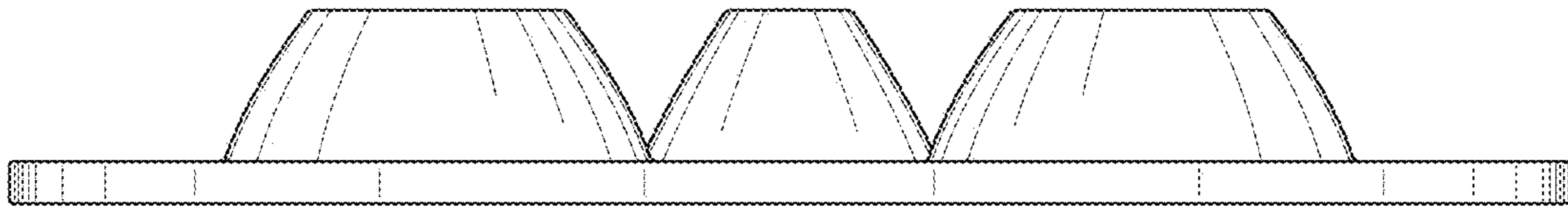

FIG. 4

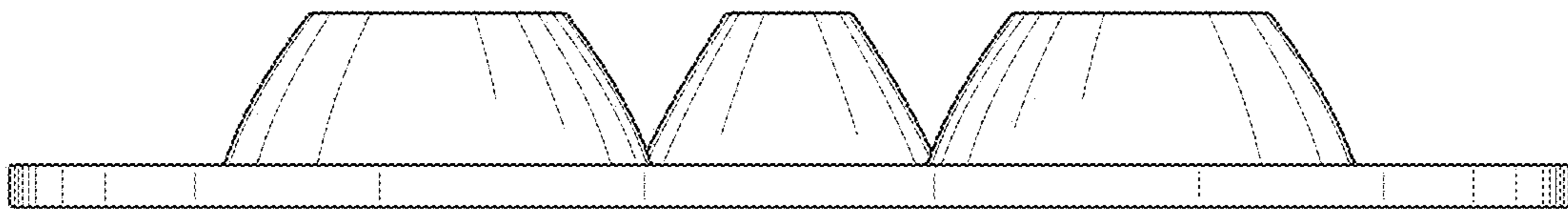

FIG. 5

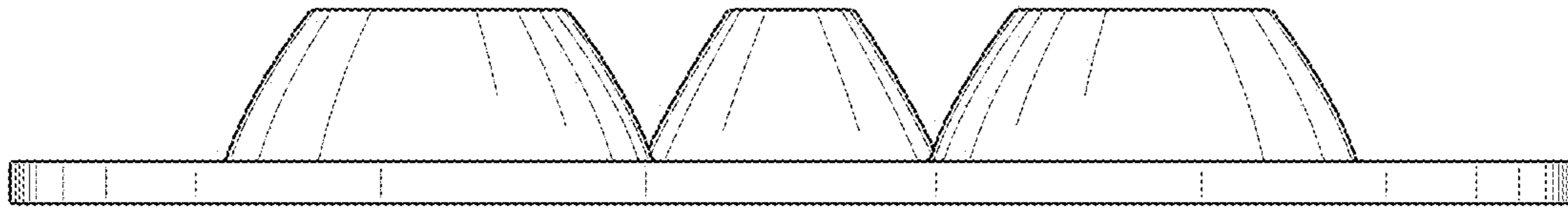

FIG. 6

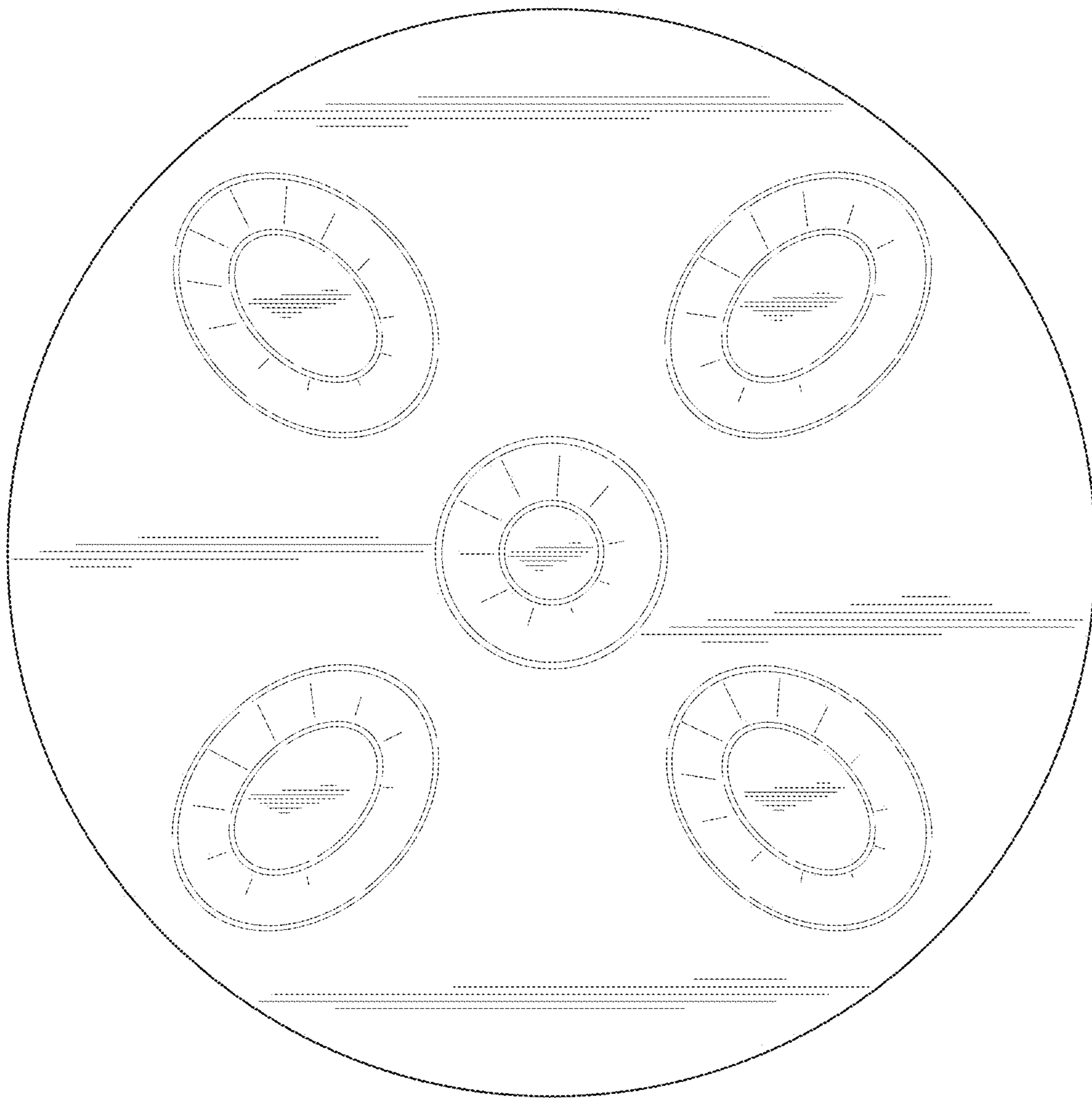

FIG. 7

FIG. 8

