



US00D937258S

(12) **United States Design Patent**
Li et al.

(10) **Patent No.:** **US D937,258 S**

(45) **Date of Patent:** **** *Nov. 30, 2021**

(54) **BUILDING CONTROLLER**

(71) Applicant: **Honeywell International Inc.**, Morris Plains, NJ (US)

(72) Inventors: **Peilin Li**, Shanghai (CN); **Haitao Li**, Beijing (CN); **Zhang Ke**, Beijing (CN); **Yidan Zhao**, Shanghai (CN); **Mu Yong**, Beijing (CN); **Cary Leen**, Hammond, WI (US); **Stefan Andreas Schmidt**, Böblingen (DE)

(73) Assignee: **Honeywell International Inc.**, Charlotte, NC (US)

(*) Notice: This patent is subject to a terminal disclaimer.

(**) Term: **15 Years**

(21) Appl. No.: **29/720,581**

(22) Filed: **Jan. 14, 2020**

(51) **LOC (13) Cl.** **14-02**

(52) **U.S. Cl.**

USPC **D14/358**; D13/162.1

(58) **Field of Classification Search**

USPC D13/162, 162.1, 184; D10/49, 50; D14/240, 358

CPC G06F 1/181; G05B 11/01; G05B 15/02; G08C 17/00; G08C 17/02; H01C 1/007; H04W 88/005; H04W 88/02; H04W 88/08; H04W 88/085; H04W 88/10; H04W 88/12; H04W 88/14; H04W 88/16; G11B 33/08; G11B 33/126; G11B 33/128; H02J 7/0042; H02J 7/0044; H02J 7/0068; H01Q 1/007

See application file for complete search history.

(56) **References Cited**

U.S. PATENT DOCUMENTS

D400,180 S 10/1998 Shimizu
D578,029 S 10/2008 Plewa

D596,963 S 7/2009 Novotny et al.
D596,964 S 7/2009 Wang et al.
D607,843 S 1/2010 Borax
D620,454 S 7/2010 Lissola et al.
D628,199 S 11/2010 Yukikado et al.
D659,652 S 5/2012 Wong

(Continued)

OTHER PUBLICATIONS

“Advantech Introduces New Direct Controller with Integrated BACNet Router-BAS-3500BC,” Advantech, 1 page, Dec. 2012.

(Continued)

Primary Examiner — Selina Sikder

(74) *Attorney, Agent, or Firm* — Seager, Tufte & Wickhem, LLP

(57)

CLAIM

The ornamental design for a building controller, as shown and described.

DESCRIPTION

FIG. 1 is a perspective view of a building controller; FIG. 2 is a front elevation view of the building controller of FIG. 1; FIG. 3 is a left view of the building controller of FIG. 1; FIG. 4 is a right side view of the building controller of FIG. 1; FIG. 5 is a top plan view of the building controller of FIG. 1; FIG. 6 is a bottom plan view of the building controller of FIG. 1; and, FIG. 7 is a perspective view of the building controller of FIG. 1 with top and bottom covers removed. In the drawings, the claimed design is defined by the shaded surfaces; broken lines immediately adjacent shaded surfaces represent boundaries of the claim and form no part thereof; all other broken lines depict unclaimed environmental subject matter and form no part of the claim.

1 Claim, 7 Drawing Sheets

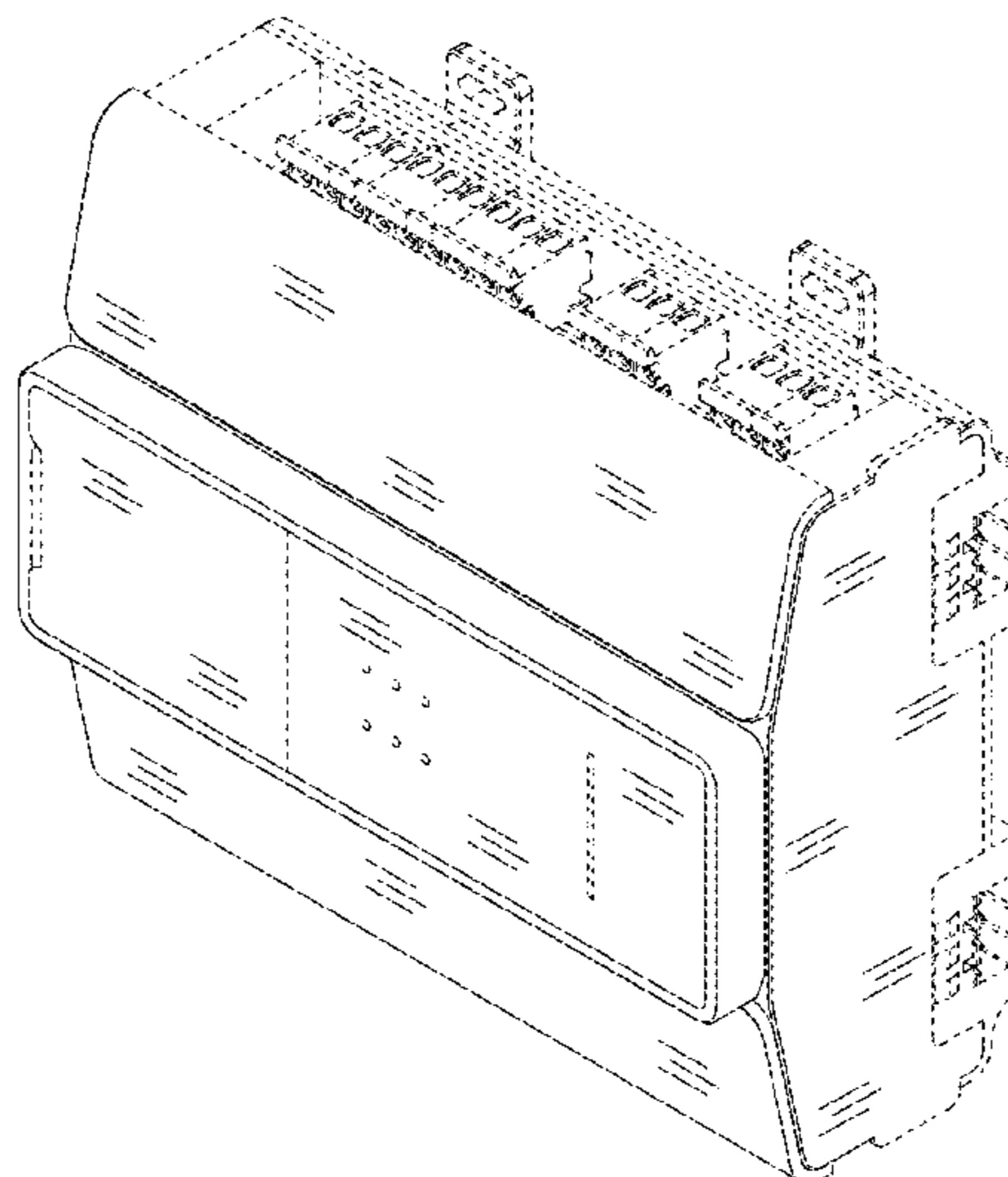

(56)

References Cited

U.S. PATENT DOCUMENTS

D678,084 S	3/2013	Beland et al.	
D705,223 S	5/2014	Akana et al.	
D720,633 S	1/2015	Novotny et al.	
D735,667 S	8/2015	Mielnik et al.	
D758,365 S	6/2016	Shimano et al.	
D762,842 S	8/2016	Kokeny et al.	
D765,031 S	8/2016	Mielnik et al.	
D768,585 S	10/2016	Moore et al.	
D774,005 S	12/2016	Ye et al.	
D792,353 S	7/2017	Yoshida et al.	
D793,967 S	8/2017	Leeland et al.	
D815,606 S	4/2018	Nada et al.	
D828,816 S	9/2018	Spors et al.	
D865,731 S	11/2019	Sun et al.	
D873,269 S	1/2020	Hu et al.	
D902,204 S *	11/2020	Li	D14/358
D902,925 S *	11/2020	Li	D14/358
D905,689 S *	12/2020	Li	D14/358
D905,690 S *	12/2020	Li	D14/358
D907,633 S *	1/2021	Li	D14/358
D914,017 S *	3/2021	Li	D14/358

OTHER PUBLICATIONS

“Advantech Launches Full-Featured Building Automation Controller Series,” Design World Staff, 9 pages, Jan. 28, 2009.
 U.S. Appl. No. 29/662,117, “Building Controller,” filed Sep. 1, 2018.

U.S. Appl. No. 29/662,118, “User Interface Module And Mounting Base For A Building Control System,” filed Sep. 1, 2018.
 JACE 8000 Controller; before Jan. 1, 2017; 6 pgs; https://www.google.com/search?q=Honeywell+International+building+controller+before%3A2017-01-01&tbm=isch&ved=2ahUKEwj70K6EsZDoAhWJBN8KHbFPB1sQ2-cCegQIABAA&oeq=Honeywell+International+building+controller+before%3A2017-01-01&gs_ =img.3...378229.396120..397891...6.
 I/O Modules UI-8/AO-4 and UI-8/AO-4-H, 2 pages, <https://ecostructure-building-help.se.com/bms/Topics/show.castle?id=807>, accessed Jan. 10, 2020.
 Distech Datasheet/ 05DI-DSEL600-17, ECL-600 and ECx-400 Series, Distech Controls, 8 pages, 2011.
 Honeywell Hardware Reference Guide, 114 pages, Jan. 2020.
 Universal Controller Screen Assign I/O HOA—Google Search, 31 pages, accessed Jan. 10, 2020. <https://www.google.com/search?client=firefox-b-1-d&biw=1812&bih=1357&tbm=isch&sa=1&ei=CsYYXu3qEeKp5wLr67qgBw&q=universal+controller+screen>.
 Peilin Li, et al., U.S. Appl. No. 29/720,608, filed Jan. 14, 2020 (9 pgs).
 Peilin Li, et al., U.S. Appl. No. 29/720,573, filed Jan. 14, 2020 (9 pgs).
 Peilin Li, et al., U.S. Appl. No. 29/720,592, filed Jan. 14, 2020 (9 pgs).
 Peilin Li, et al., U.S. Appl. No. 29/720,594, filed Jan. 14, 2020 (9 pgs).
 Peilin Li, et al., U.S. Appl. No. 29/720,605, filed Jan. 14, 2020 (9 pgs).

* cited by examiner

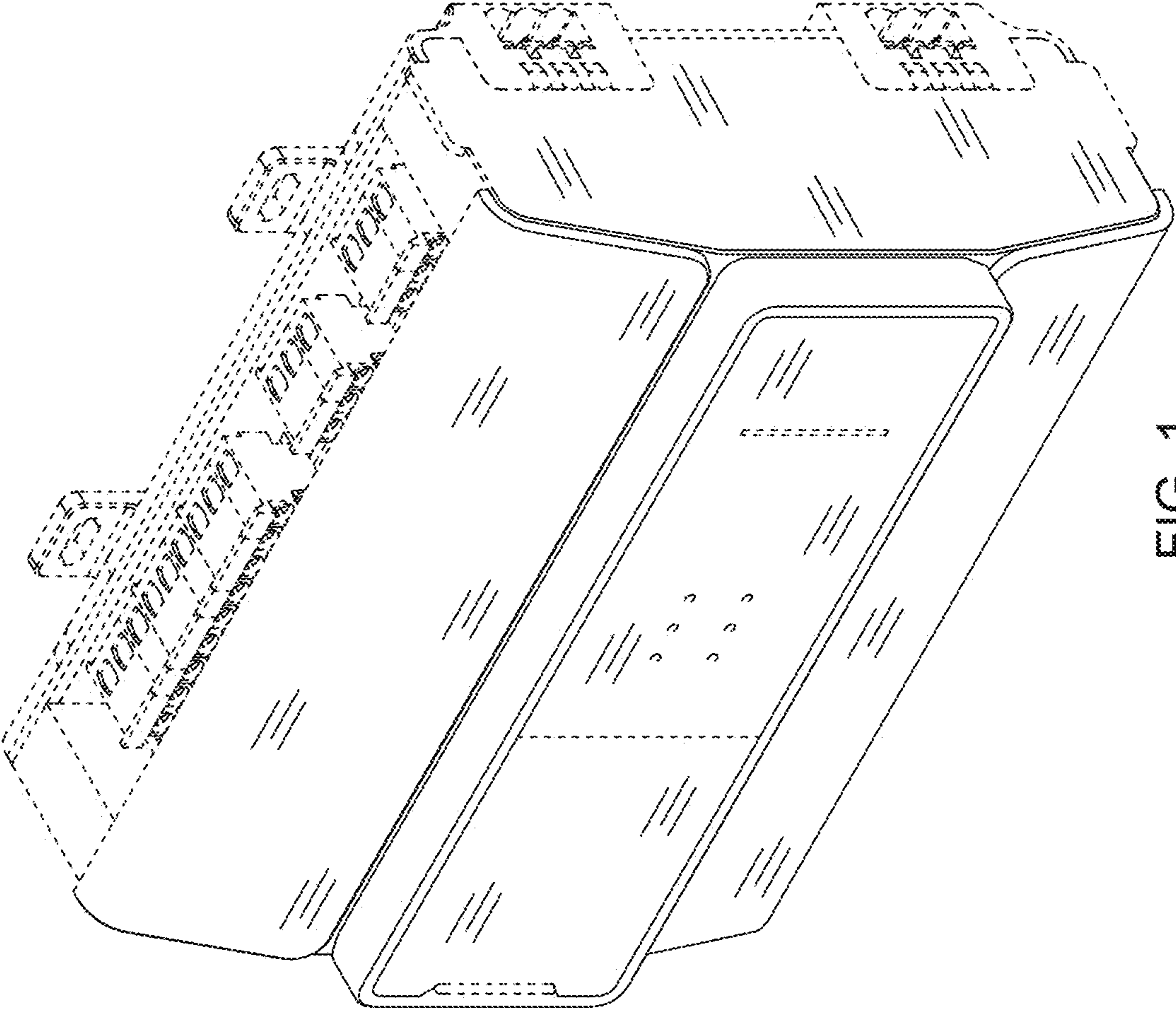

FIG. 1

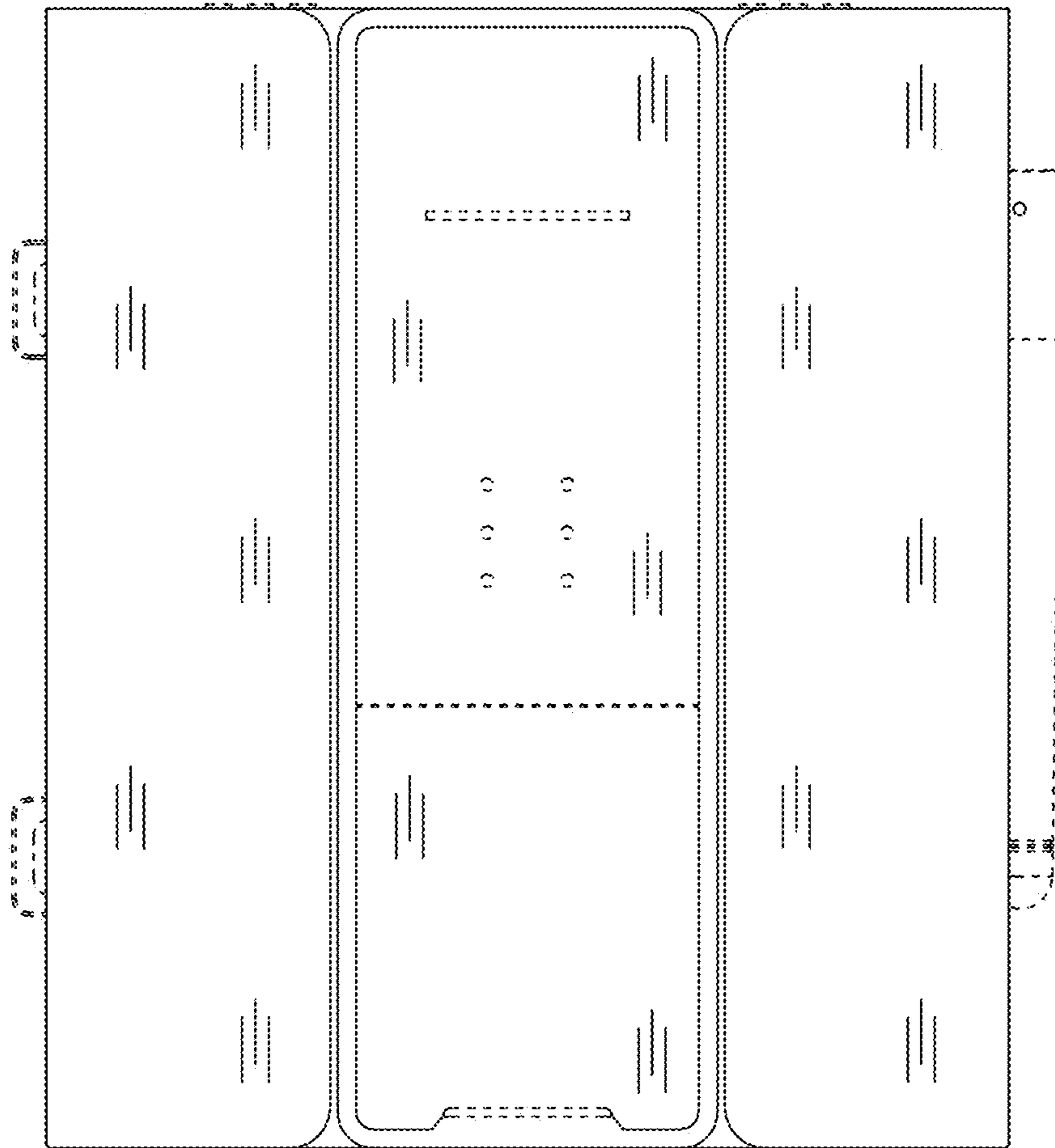

FIG. 2

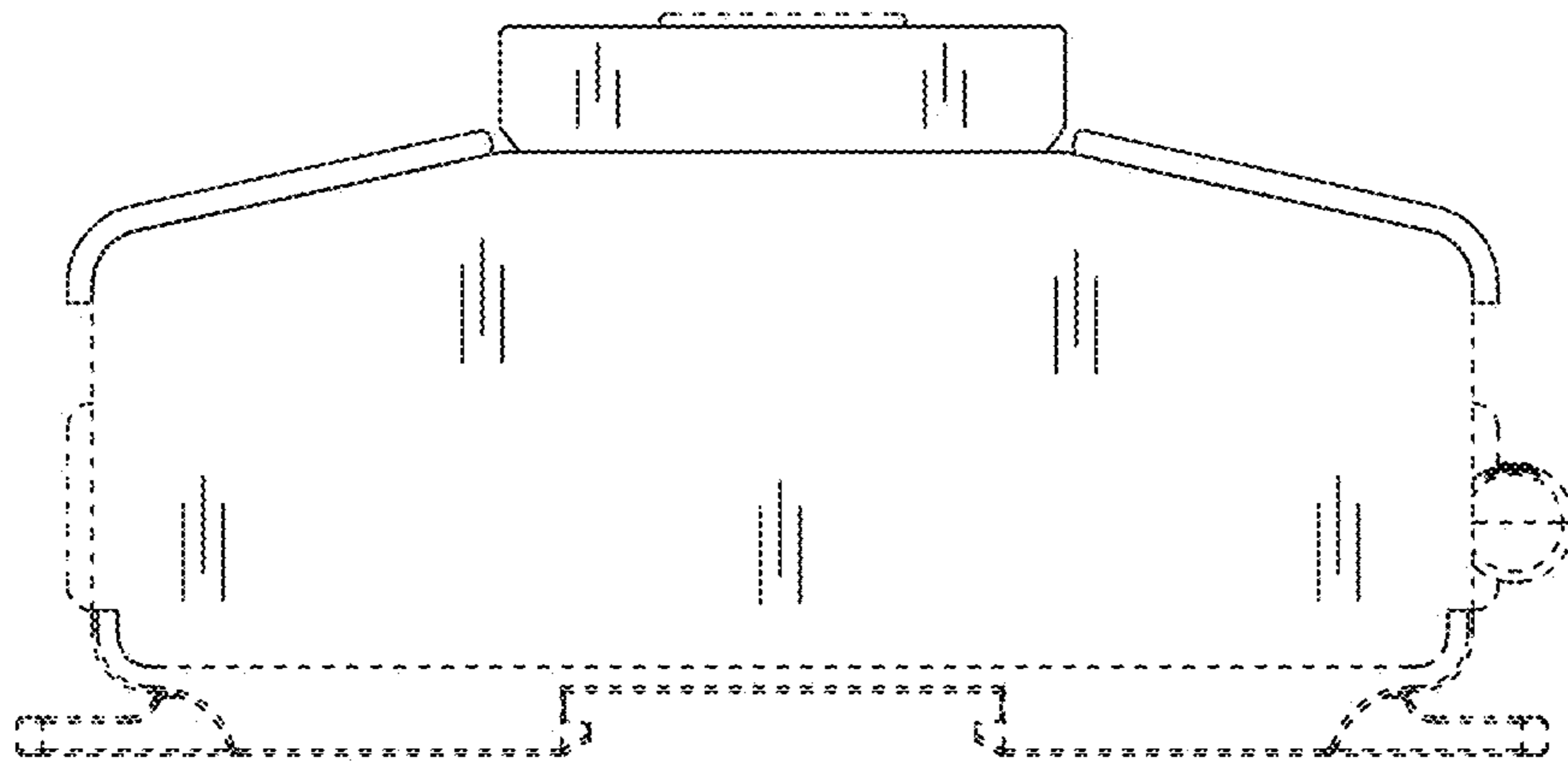

FIG. 3

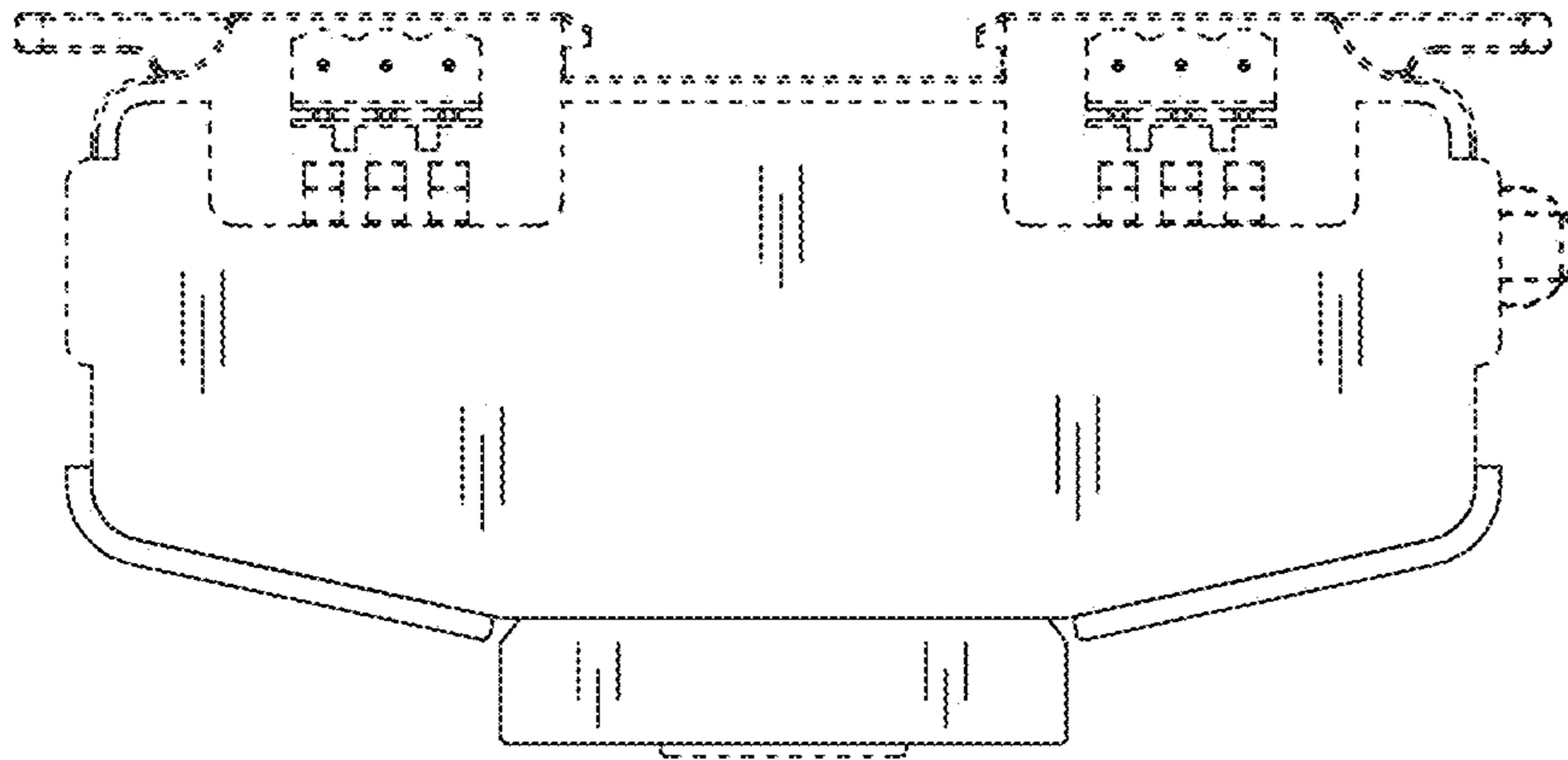

FIG. 4

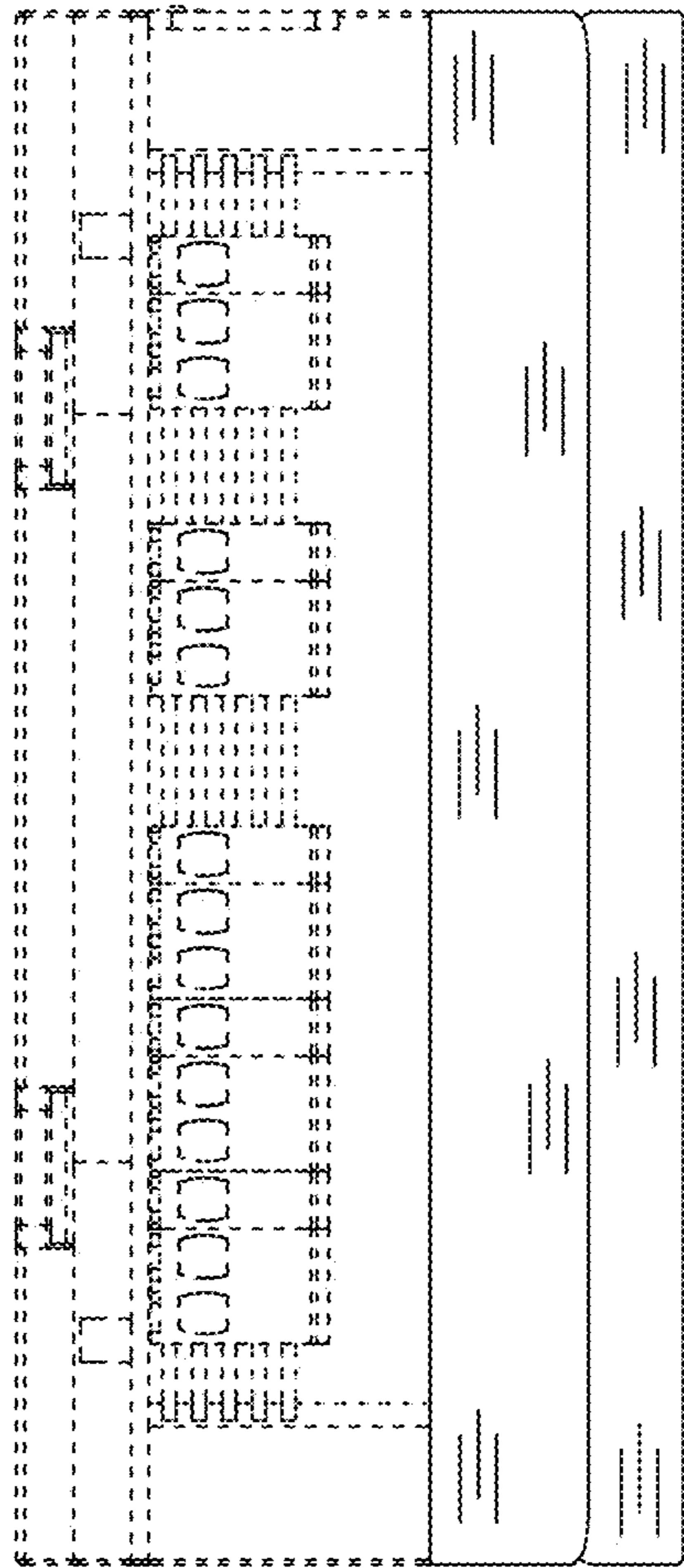

FIG. 5

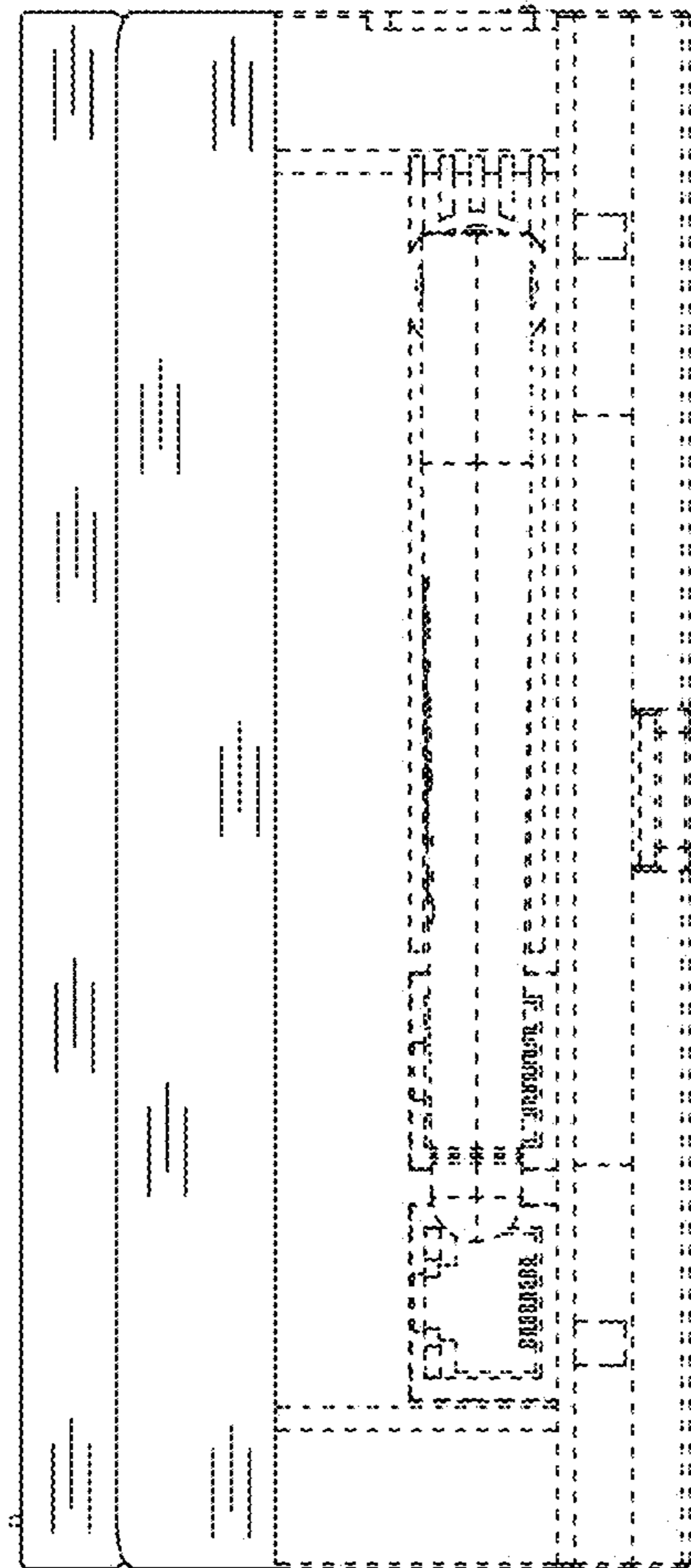

FIG. 6

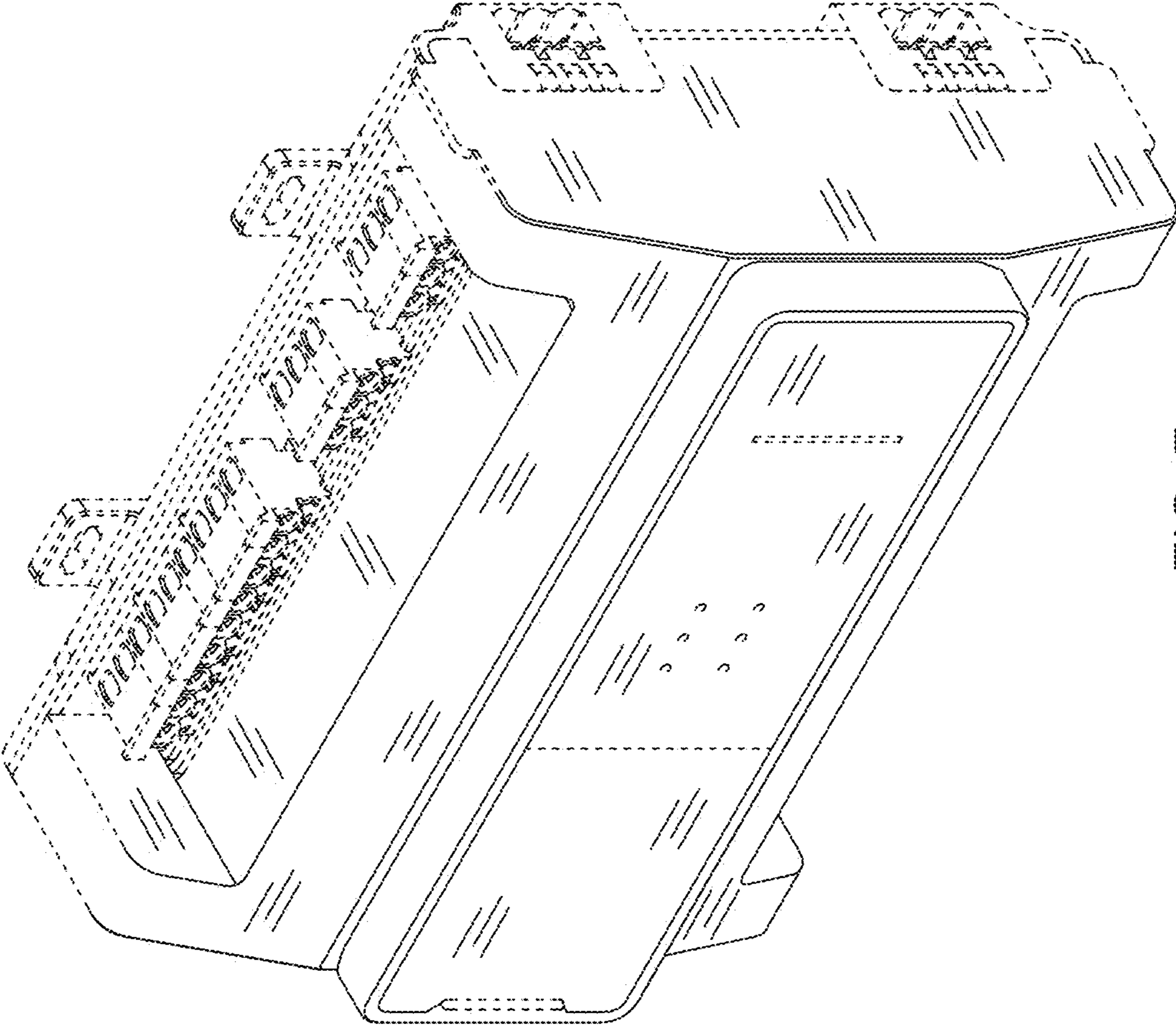

FIG. 7