



US00D937215S

(12) **United States Design Patent** (10) **Patent No.:** **US D937,215 S**
Garrett et al. (45) **Date of Patent:** **** Nov. 30, 2021**

(54) **CABLE CONNECTOR**

(71) Applicant: **Jem Accessories, Inc.**, Edison, NJ (US)

(72) Inventors: **Jennifer Garrett**, Rahway, NJ (US);
Elie Chemtob, Eatontown, NJ (US);
Akinyemi Fapohunda, Brooklyn, NY (US)

(73) Assignee: **Jem Accessories, Inc.**, Edison, NJ (US)

(**) Term: **15 Years**

(21) Appl. No.: **29/728,506**

(22) Filed: **Mar. 19, 2020**

(51) **LOC (13) Cl.** **13-03**

(52) **U.S. Cl.**
USPC **D13/133**

(58) **Field of Classification Search**
USPC D13/120, 121, 133, 146, 147, 153, 199,
D13/154, 156, 184; D14/432, 433, 434,
D14/435.1, 438

CPC .. H01R 13/506; H01R 13/516; H01R 13/518;
H01R 13/58; H01R 13/627; H01R
13/6315; H01R 13/00; H01R 13/24;
H01R 13/26; H01R 13/28; H01R 13/508;
H01R 13/523; H01R 13/585; H01R
13/6271; H01R 13/6275; H01R 13/635;
H01R 13/639; H01R 13/64; H01R
13/642; H01R 13/6453; H01R 13/6474;
H01R 13/6581; H01R 13/6582; H01R
13/6586; H01R 13/6587; H01R 13/6588;
H01R 13/659; H01R 13/6591; H01R
13/6594; H01R 13/6595; H01R 13/6597;
H01R 13/66; H01R 13/6658; H01R
24/00; H01R 24/60; H01R 24/62; H01R
24/64; H01R 12/51; H01R 12/52; H01R
12/55; H01R 12/57; H01R 12/58; H01R
12/592; H01R 12/61; H01R 12/616;
H01R 12/63; H01R 12/70; H01R
12/7005; H01R 12/7076; H01R 12/71;
H01R 12/714; H01R 12/716; H01R

(Continued)

(56) **References Cited**

U.S. PATENT DOCUMENTS

D553,568 S * 10/2007 Lee D13/133
D631,444 S * 1/2011 Garay D13/153
D692,390 S * 10/2013 Smith D13/153
D705,175 S * 5/2014 Chu D13/147

(Continued)

OTHER PUBLICATIONS

“Monster High Speed 4K HDR HDMI Cable with Built-in Red LED Light” first reviewed Dec. 4, 2019. Walmart.com (<https://www.walmart.com/reviews/product/400664513?sort=submission-asc>) (Year: 2019).*

(Continued)

Primary Examiner — Rosemary K Tarcza

Assistant Examiner — Seth David Kumpf

(74) *Attorney, Agent, or Firm* — Goldberg Cohen LLP

(57) **CLAIM**

We claim the ornamental design for a cable connector, as shown and described.

DESCRIPTION

FIG. 1 is an isometric top, right side view of a first embodiment of a cable connector;
FIG. 2 is an isometric top, right side view of a second embodiment of a cable connector;
FIG. 3 is an enlarged isometric top, right side view of a first embodiment of a cable connector;
FIG. 4 is a top view thereof;
FIG. 5 is a bottom view thereof;
FIG. 6 is a left side view thereof;
FIG. 7 is a right side view thereof;
FIG. 8 is a rear view thereof; and,
FIG. 9 is a front view thereof.

The evenly spaced broken lines in the drawings depict portions of the embodiments of the cable connector which form no part of the claim.

1 Claim, 7 Drawing Sheets

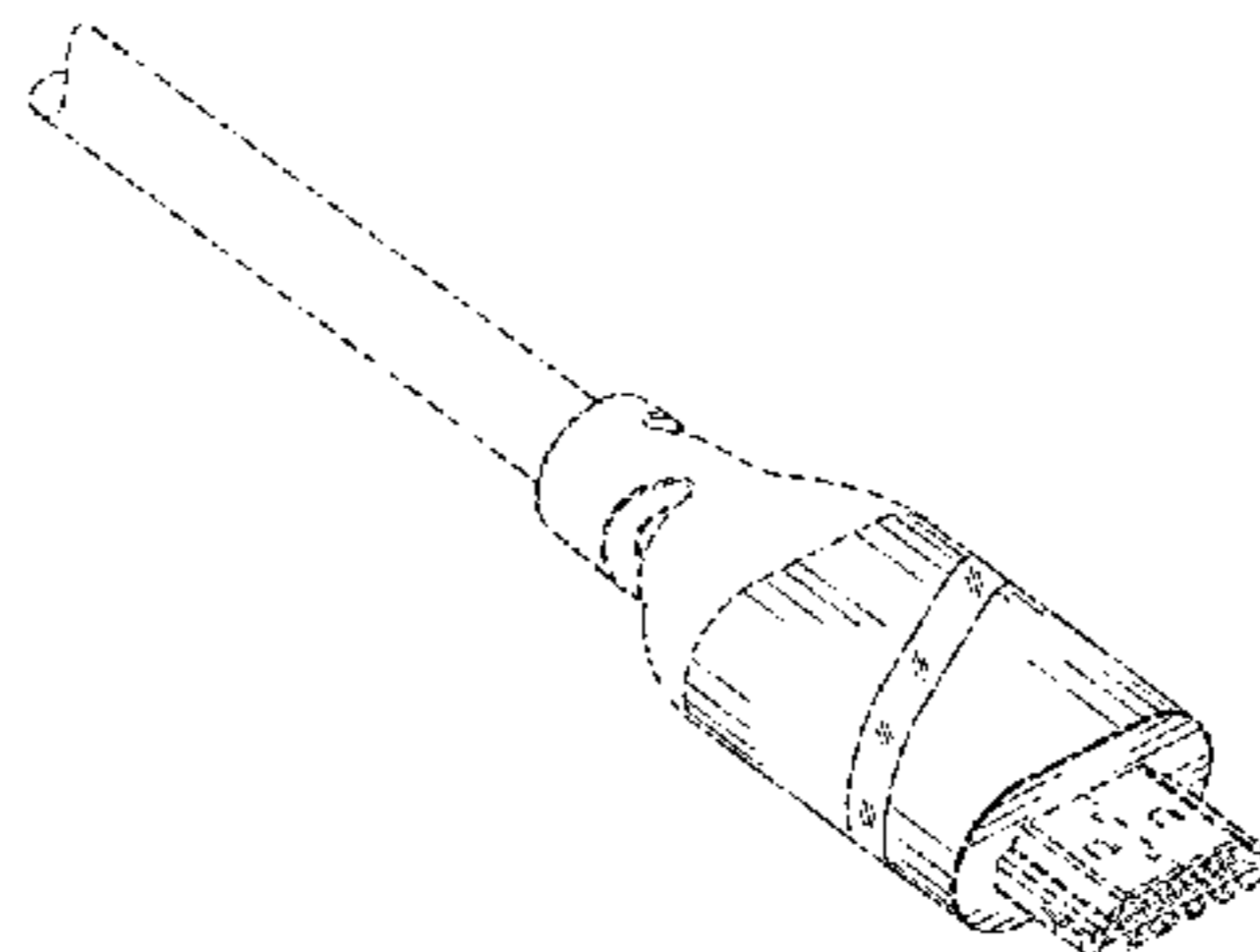
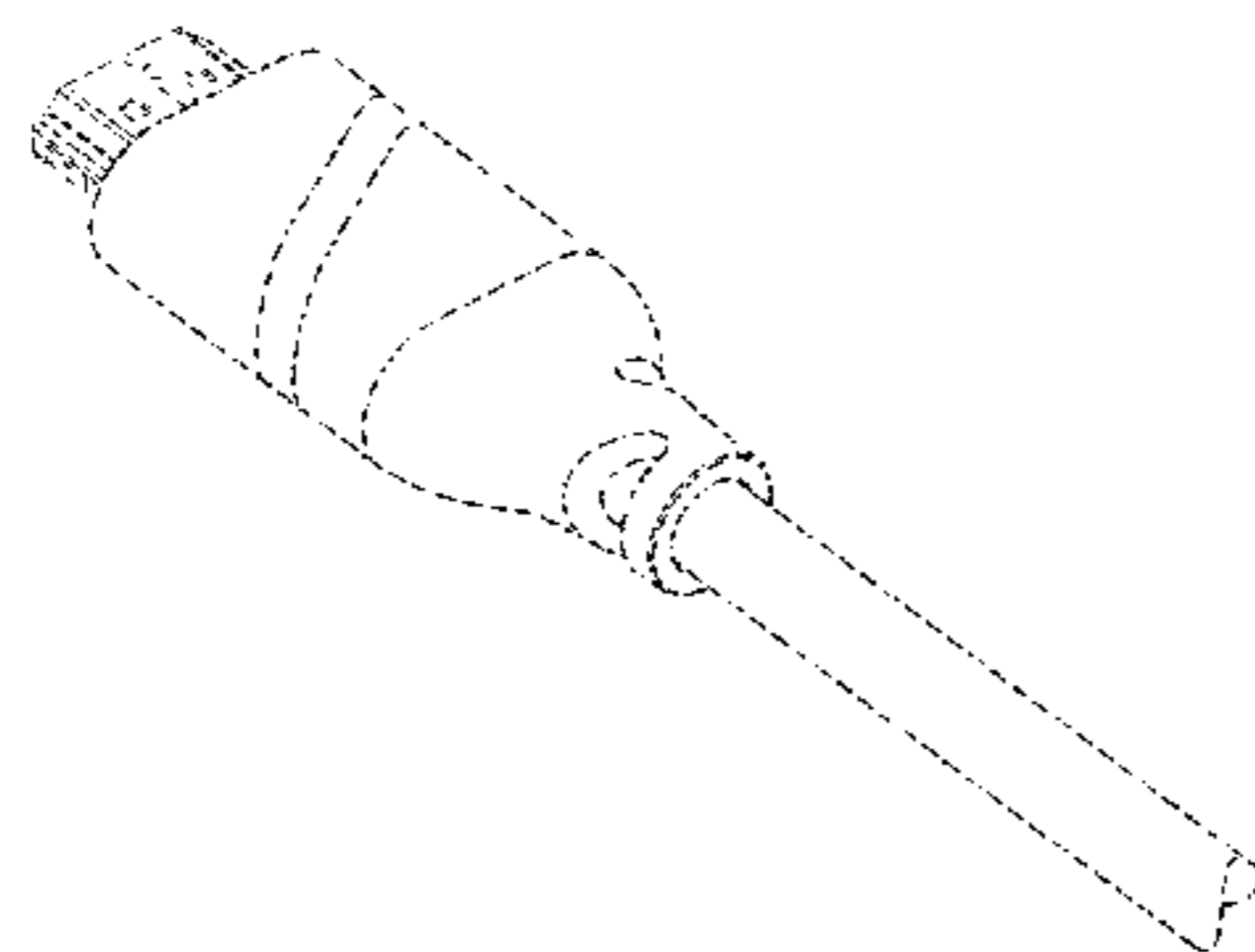

(58) **Field of Classification Search**

CPC 12/718; H01R 12/72; H01R 12/73; H01R
 12/737; H01R 12/777; H01R 12/778;
 H01R 12/79; H01R 25/006; H01R 27/02;
 H01R 31/005; G06F 1/1607; G06F
 1/1632; G06F 1/1684; G06F 13/382

See application file for complete search history.

(56) **References Cited**

U.S. PATENT DOCUMENTS

D738,312 S	*	9/2015	Bress	D13/147
D824,388 S	*	7/2018	Fawcett	D14/433
D843,948 S	*	3/2019	Akana	D13/147

OTHER PUBLICATIONS

“Monster High Speed 4K HDR HDMI Cable with Built-in Red LED Light—6ft”, First accessed Feb. 8, 2021. Walmart.com [<https://www.walmart.com/ip/Monster-High-Speed-4K-HDR-HDMI-Cable-with-Built-in-Red-LED-Light-6ft/400664513>] (Year: 2021).*

“50ft (15.2M) High Speed HDMI Cable Male to Male with Ethernet Black (50 Feet/15.2 Meters) Supports 4K 30Hz, 3D, 1080p and Audio Return CNE59007”, First available Jan. 7, 2015. Amazon.com [https://www.amazon.com/Ethernet-Meters-Supports-Return-CNE59007/dp/B00RYRJYDG/ref=sr_1_7?dchild=1&keywords=Monster+High+Speed+4%E2%80%A6](Year: 2015).*

“Monster Ultra High-Speed 8K Cobalt HDMI 2.1 6ft Cable at 48 Gbps for Apple TV, Roku, Samsung, QLED, Sony, LG, Playstation, PS5, PS4 and Xbox”, First available Sep. 21, 2020. Amazon.com [https://www.amazon.com/Monster-High-Speed-Cobalt-Samsung-Playstation/dp/B08KWHHM9V/ref=sr_1_11?dchild=1&keywords=Monster+High+Spe%E2%80%A6](Year: 2020).*

* cited by examiner

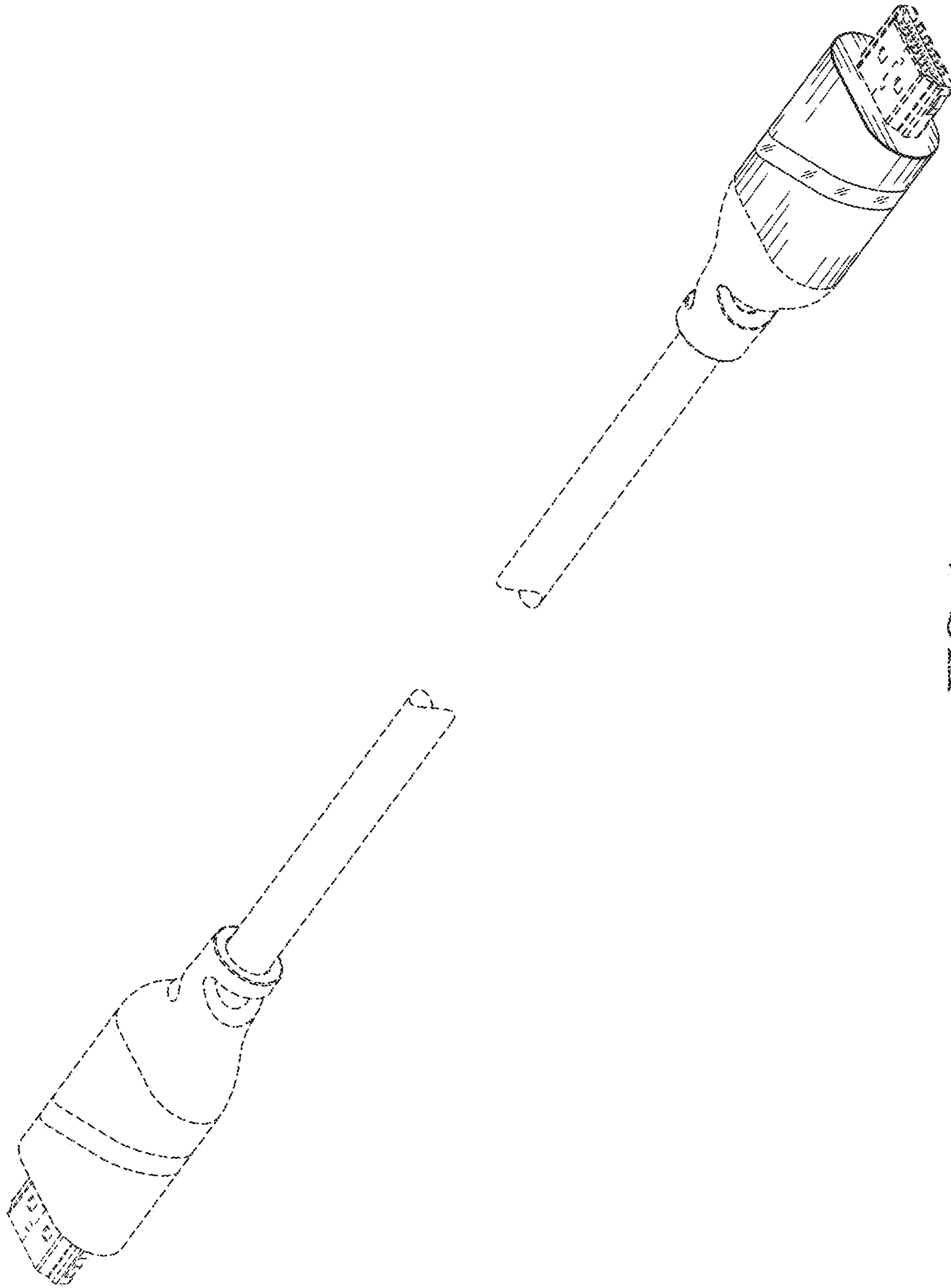

FIG. 1

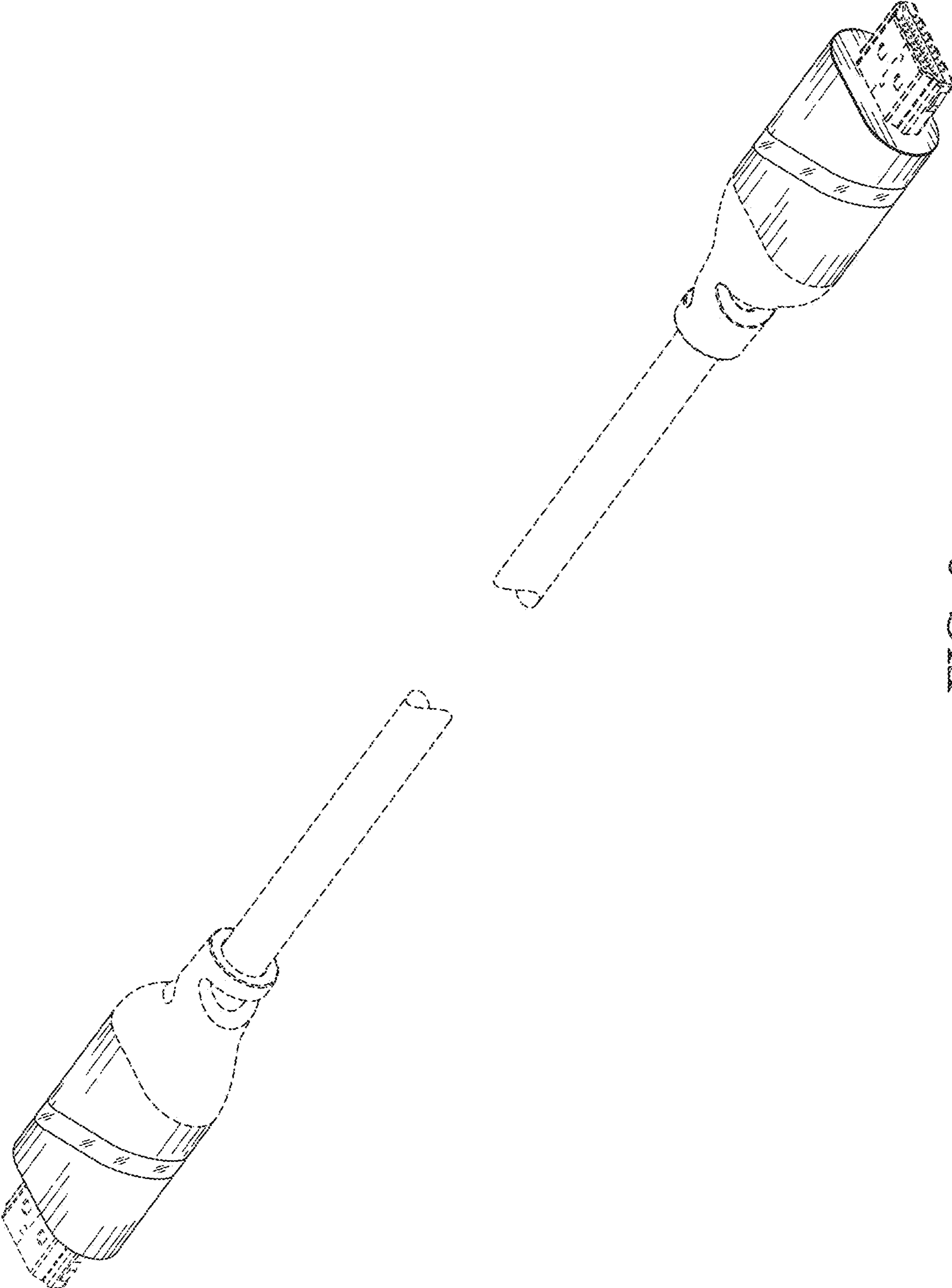

FIG. 2

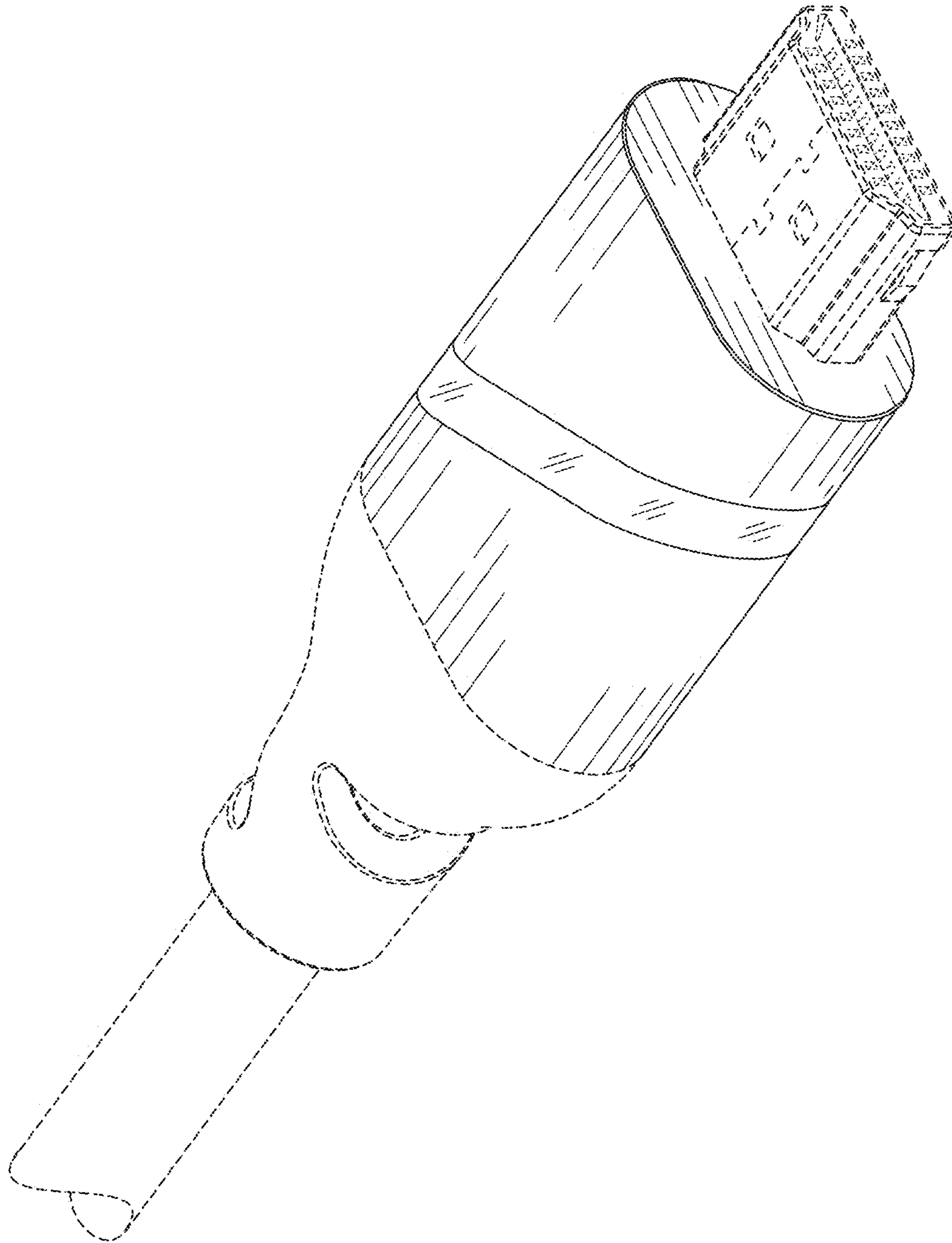

FIG. 3

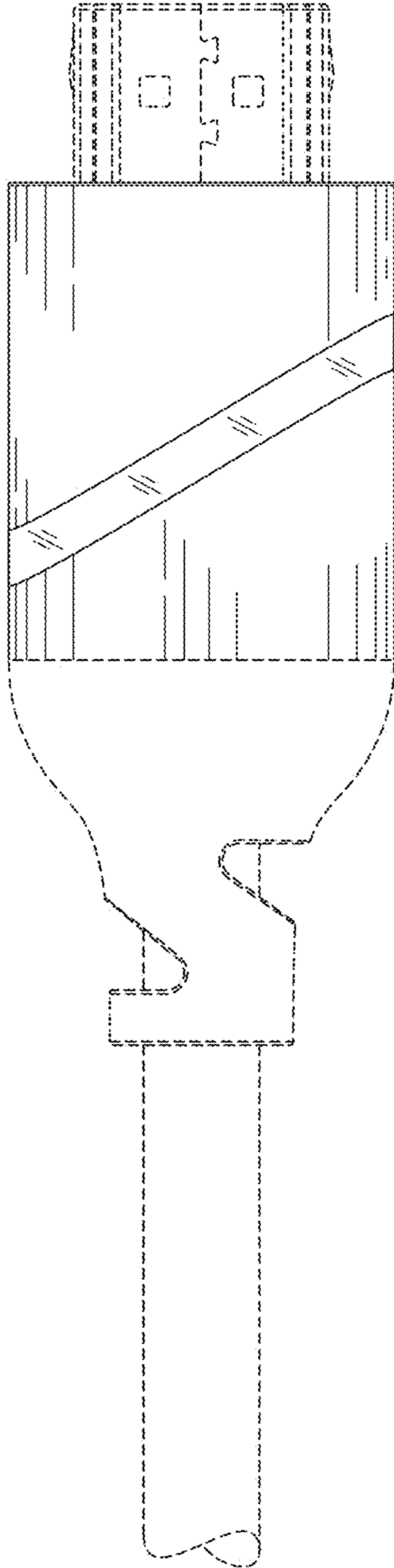

FIG. 4

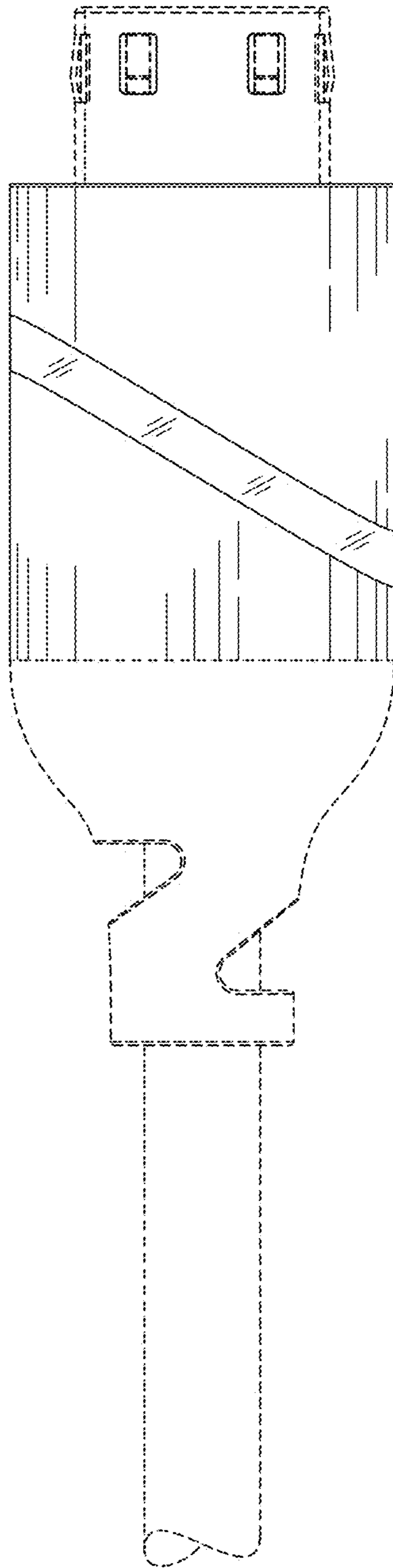

FIG. 5

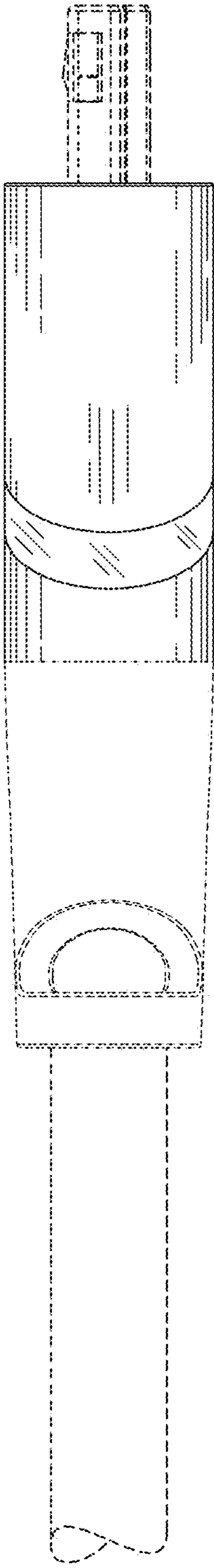

FIG. 6

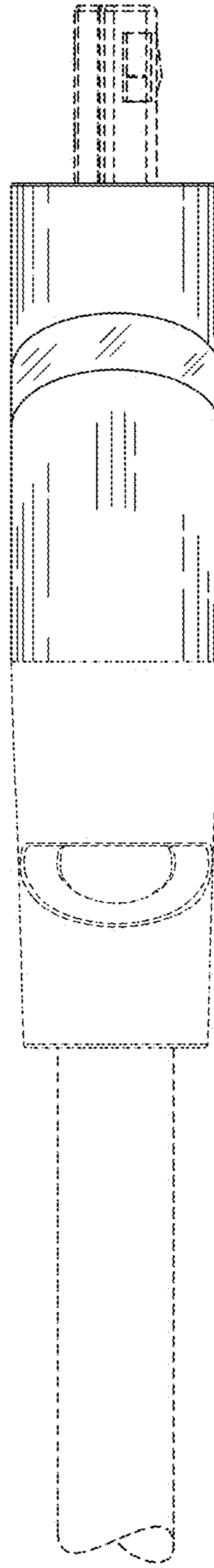

FIG. 7

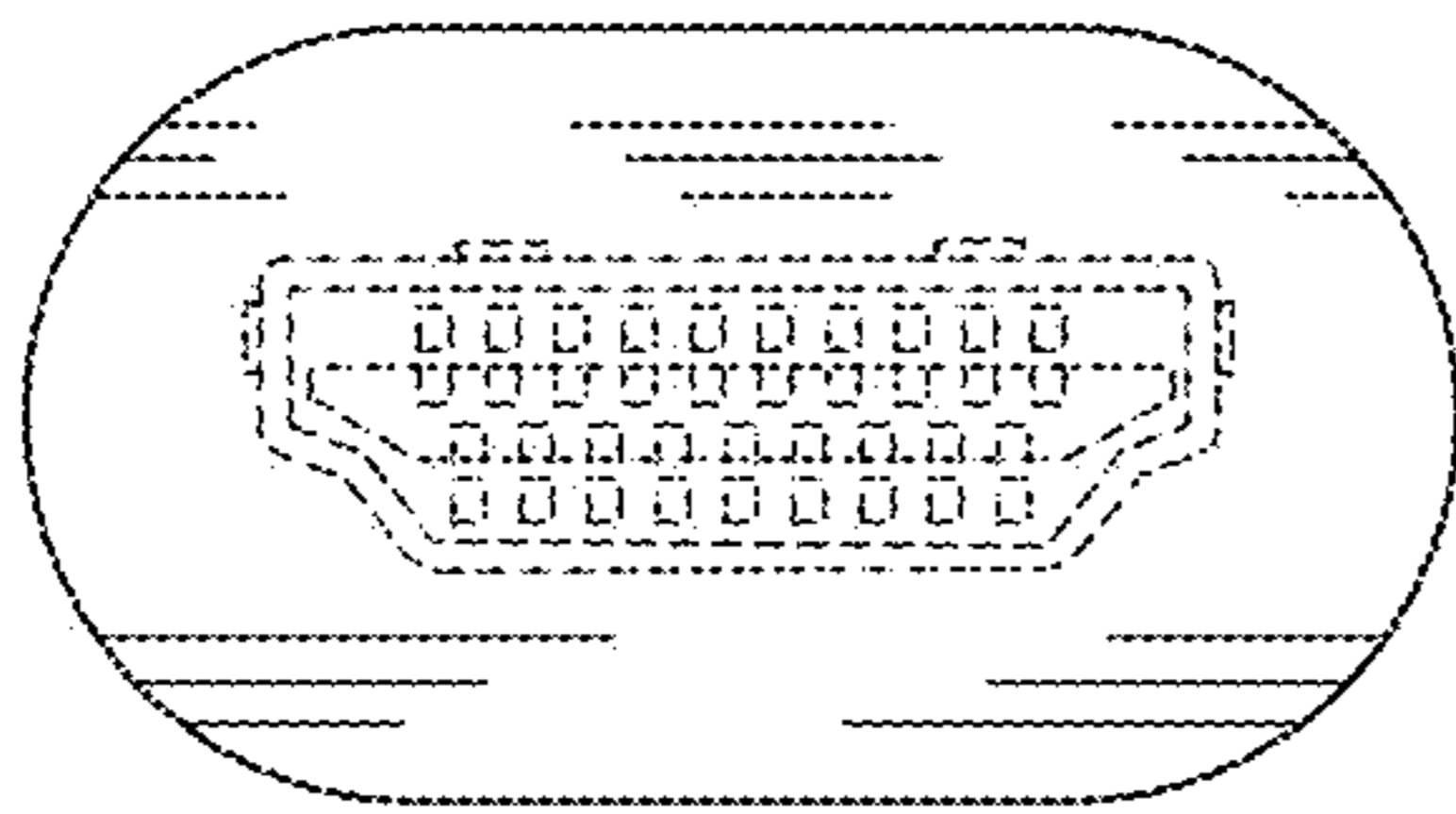

FIG. 9

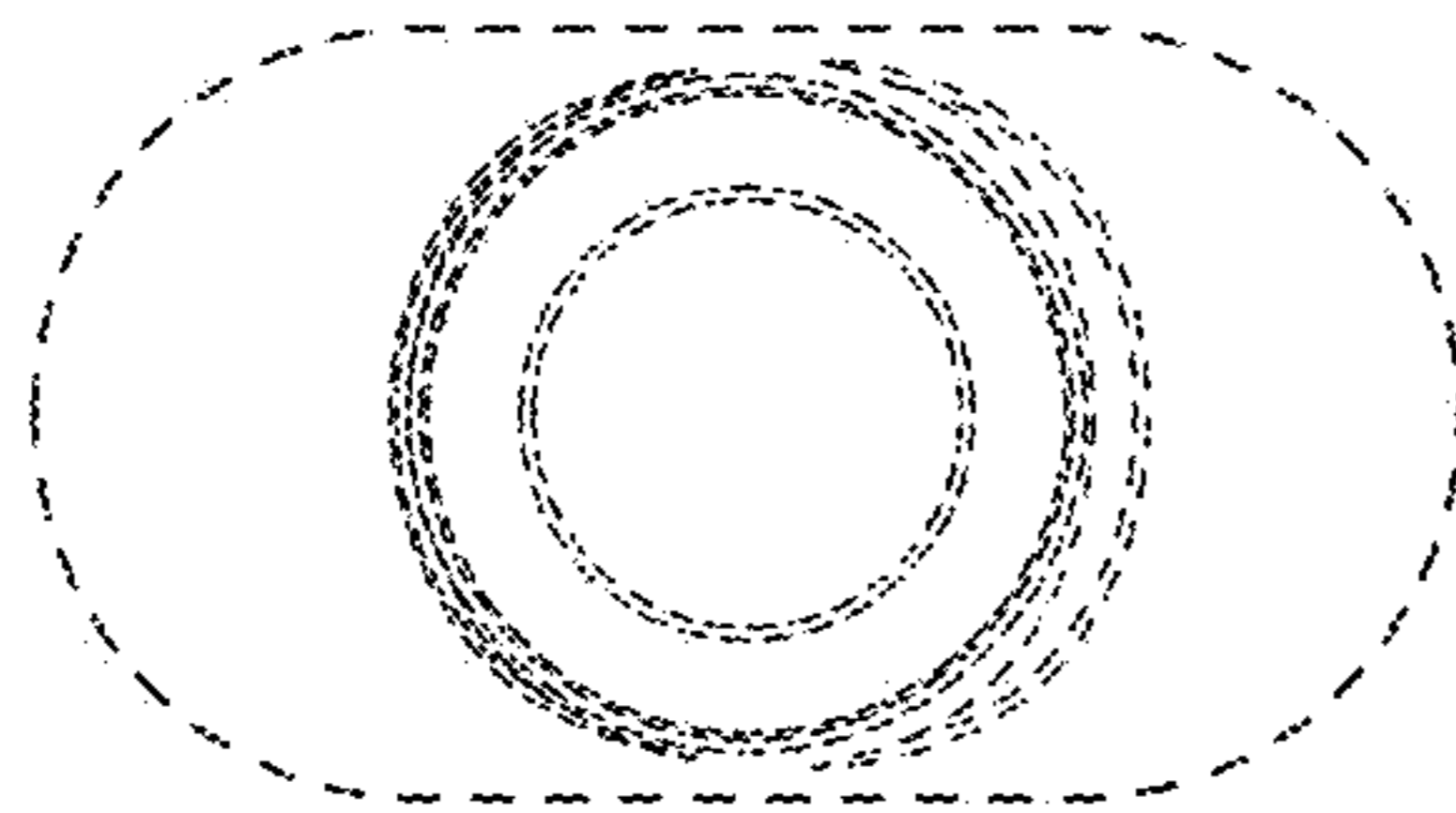

FIG. 8