

US00D937084S

(12) **United States Design Patent** (10) **Patent No.:** **US D937,084 S**
Pampus (45) **Date of Patent:** **** Nov. 30, 2021**

(54) **BOTTLE STOPPER**
(71) Applicant: **Jos Pampus**, Amersfoort (NL)
(72) Inventor: **Jos Pampus**, Amersfoort (NL)
(**) Term: **15 Years**

D382,800 S * 8/1997 Dederling D24/199
D407,944 S * 4/1999 Filbrun D7/388
D586,680 S * 2/2009 Bober D10/101
10,676,256 B2 * 6/2020 Faragher B65D 50/041
2015/0014367 A1 * 1/2015 VanSyckel B65D 47/121
222/399

(21) Appl. No.: **35/508,497**
(22) Filed: **Apr. 3, 2019**

OTHER PUBLICATIONS

Rediff Shop & Gift. No date specified. <http://shopping.rediff.com/product/nomader%20collapsible%20water%20bottle%20w%20carry%20strap%20and%20durable%20twist%20cap%202oz/cat-615> (Year: 0).*

(80) **Hague Agreement Data**

Int. Filing Date: **Apr. 3, 2019**
Int. Reg. No.: **DM/205530**
Int. Reg. Date: **Apr. 3, 2019**
Int. Reg. Pub. Date: **Feb. 7, 2020**

* cited by examiner

Primary Examiner — Darcey E Gottschalk

(51) **LOC (13) Cl.** **09-07**
(52) **U.S. Cl.**
USPC **D9/439**
(58) **Field of Classification Search**
USPC D9/434, 499, 439, 449; D7/396.3
CPC B65D 47/121; B65D 47/32
See application file for complete search history.

(57) **CLAIM**

The ornamental design for a bottle stopper, as shown and described.

(56) **References Cited**

U.S. PATENT DOCUMENTS

D23,091 S * 2/1894 Bailey D9/439
D32,085 S * 1/1900 Estes D9/439
D143,581 S * 1/1946 de Waltoff D9/449
D223,854 S * 6/1972 Swett D7/392.1
D333,342 S * 2/1993 Newhard 4/286
D334,616 S * 4/1993 Nimmo D23/249
D335,700 S * 5/1993 Sarnoff D23/261
D337,726 S * 7/1993 O'Neill D9/435
D339,069 S * 9/1993 Mansau D9/439

DESCRIPTION

Fig. 1.1 is a Perspective view of the bottle stopper;
Fig. 1.2 is a Front view in an environment of use thereof;
Fig. 1.3 is a Front in alternate configuration in an environment of use thereof;
Fig. 1.4 is a Top view thereof;
Fig. 1.5 is a Side view thereof;
Fig. 1.6 is a Perspective view thereof; and
Fig. 1.7 is a Perspective view thereof.
The broken lines in Figs. 1.2 and 1.3 represent environment and form no part of the claimed design.

1 Claim, 7 Drawing Sheets

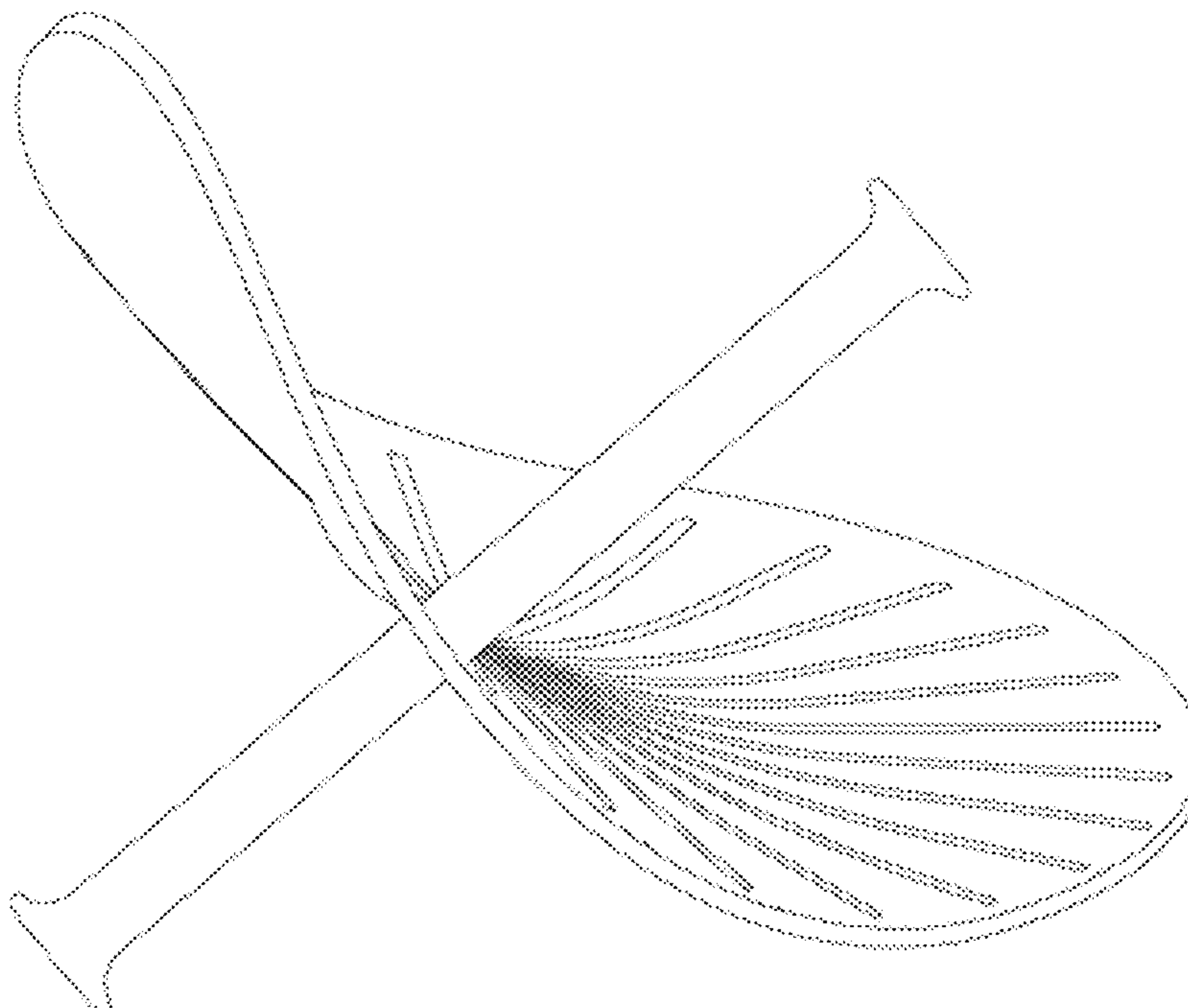

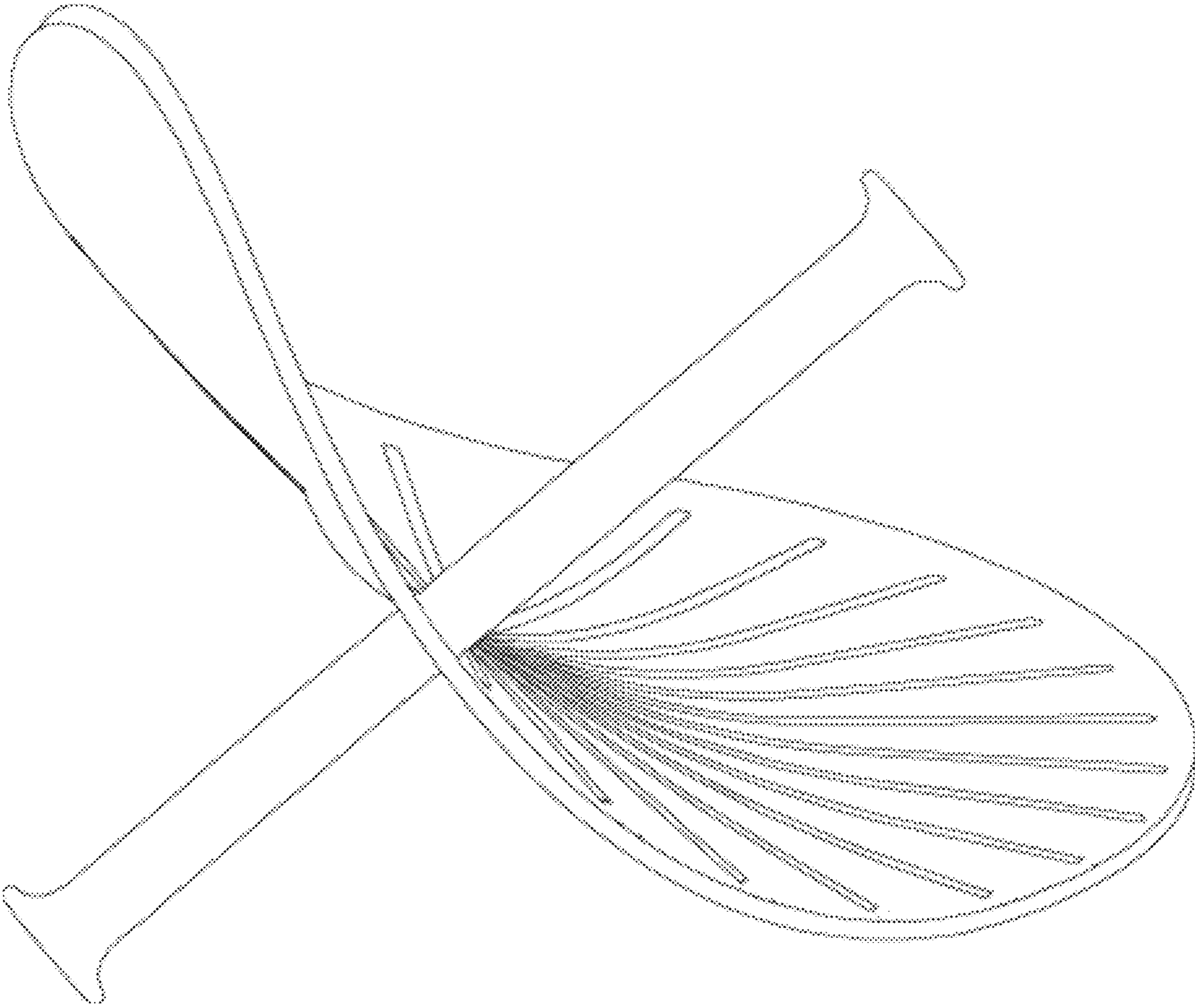

FIG. 1.1

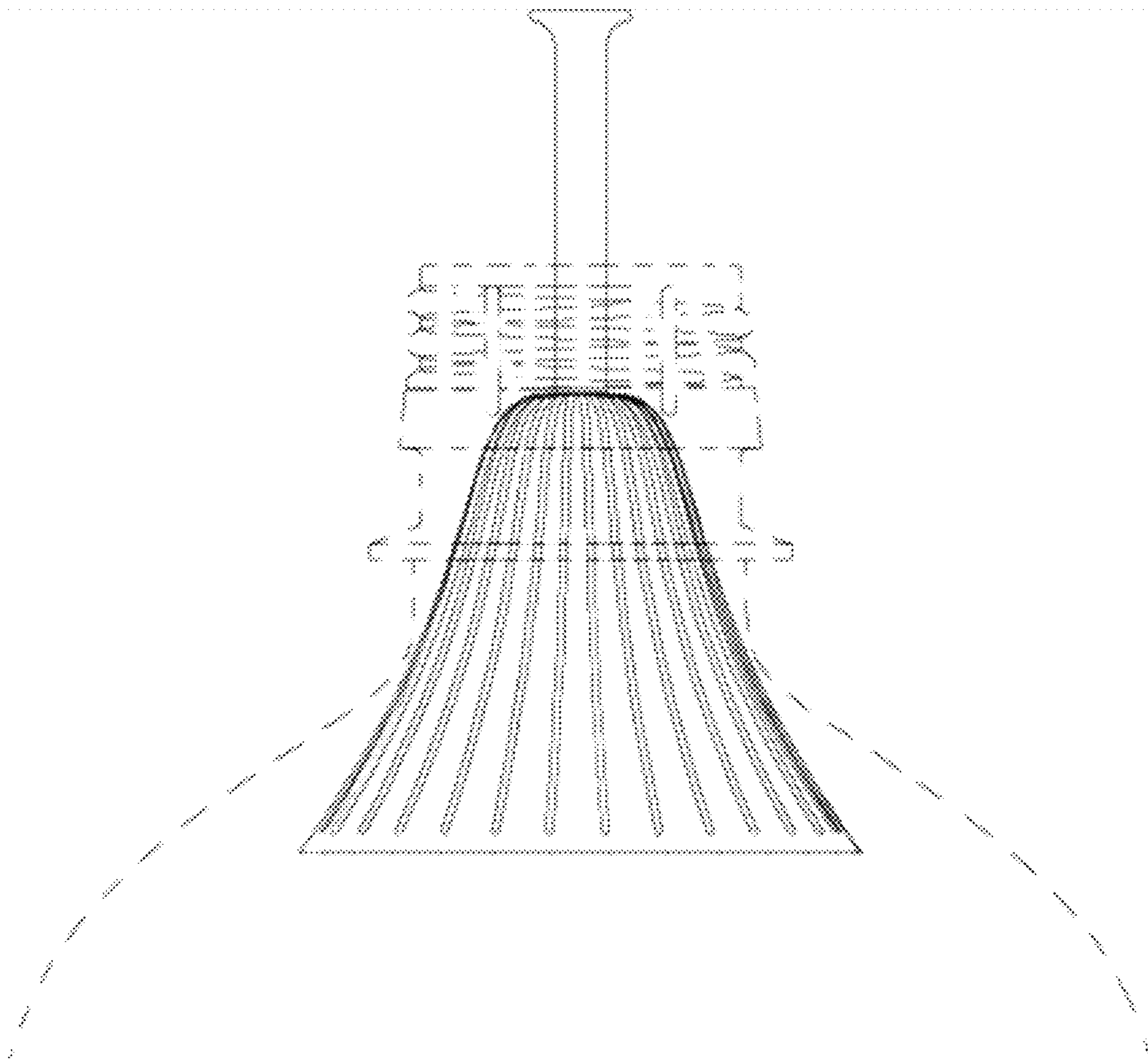

FIG. 1.2

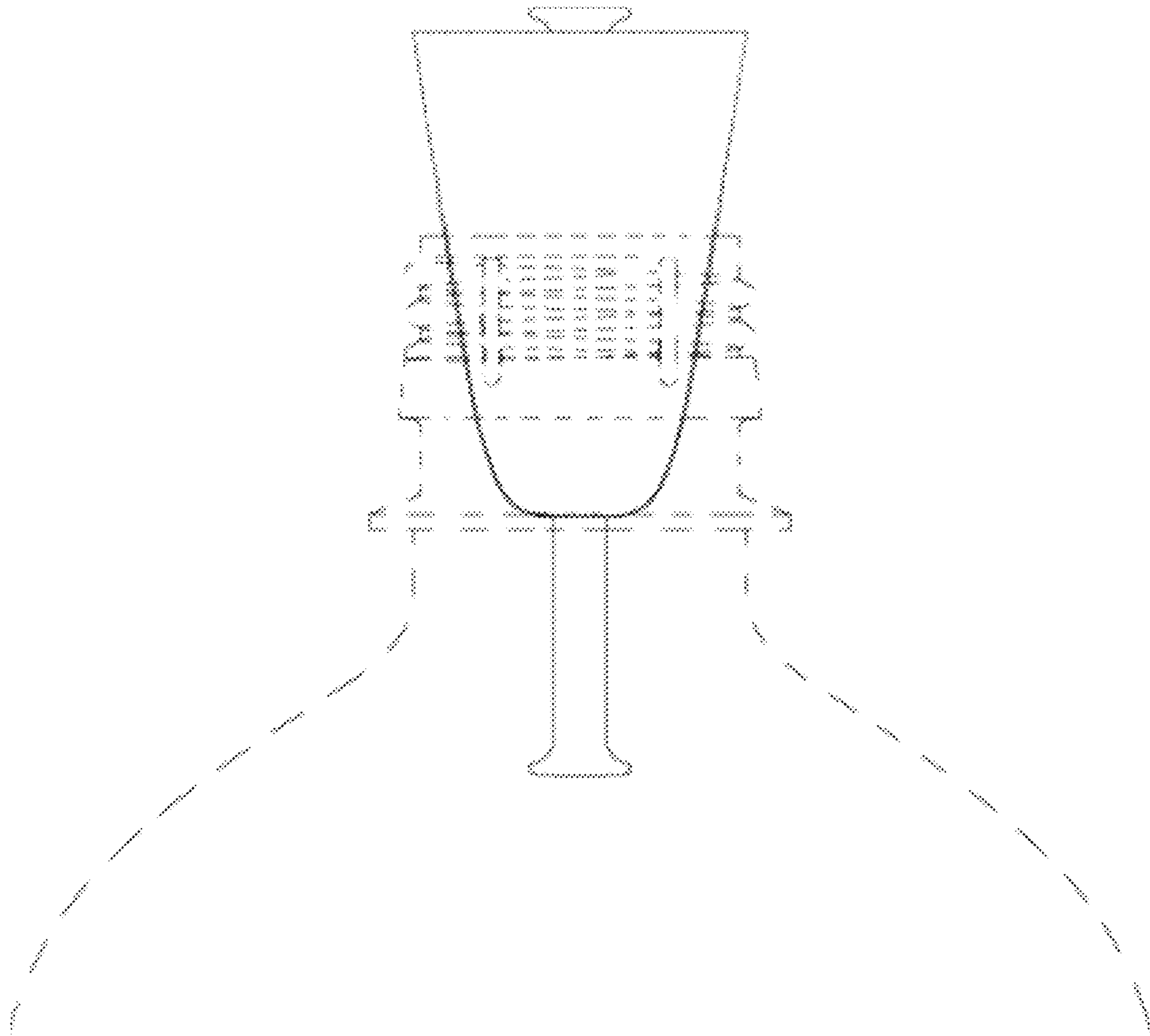

FIG. 1.3

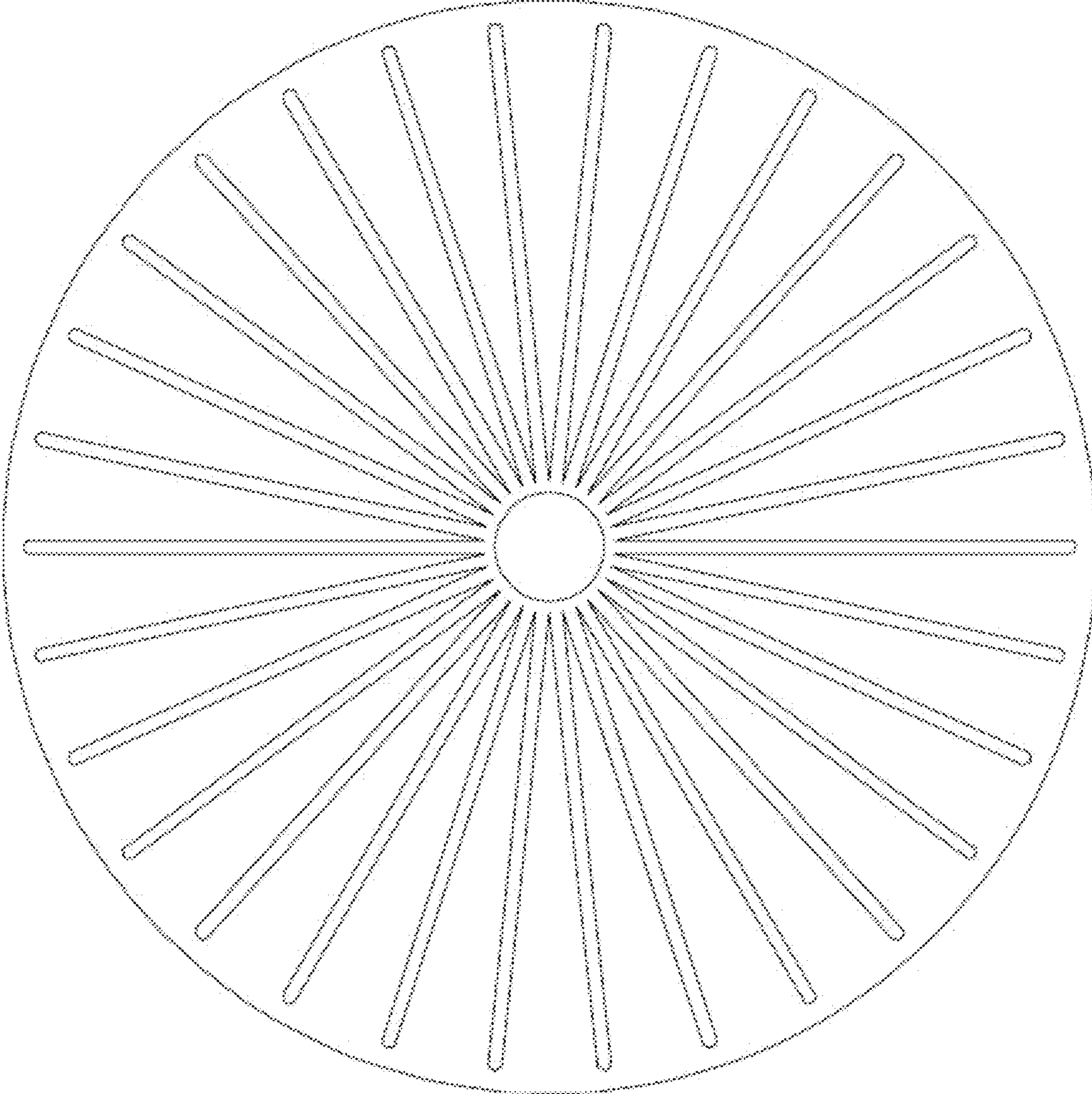

FIG. 1.4

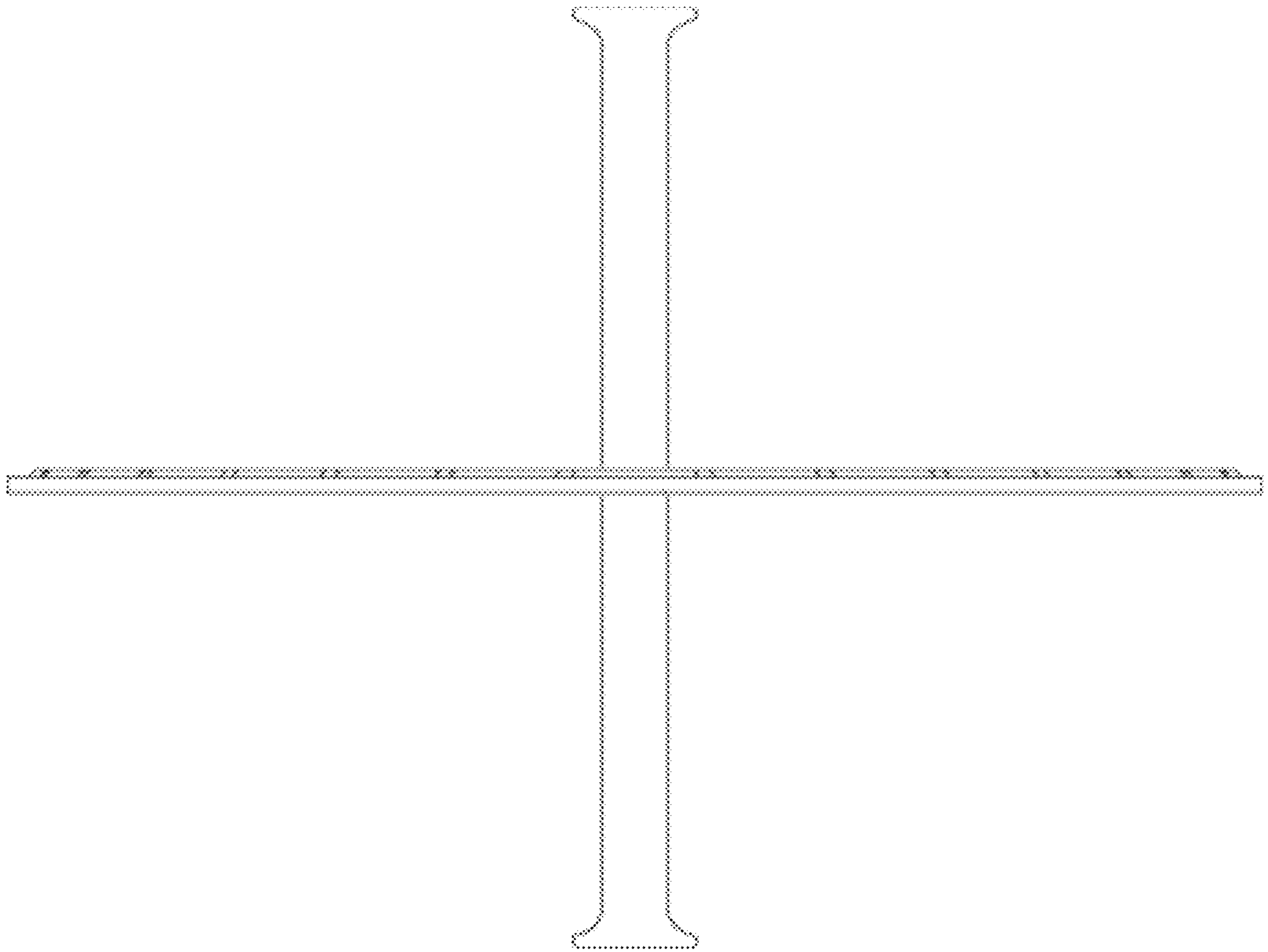

FIG. 1.5

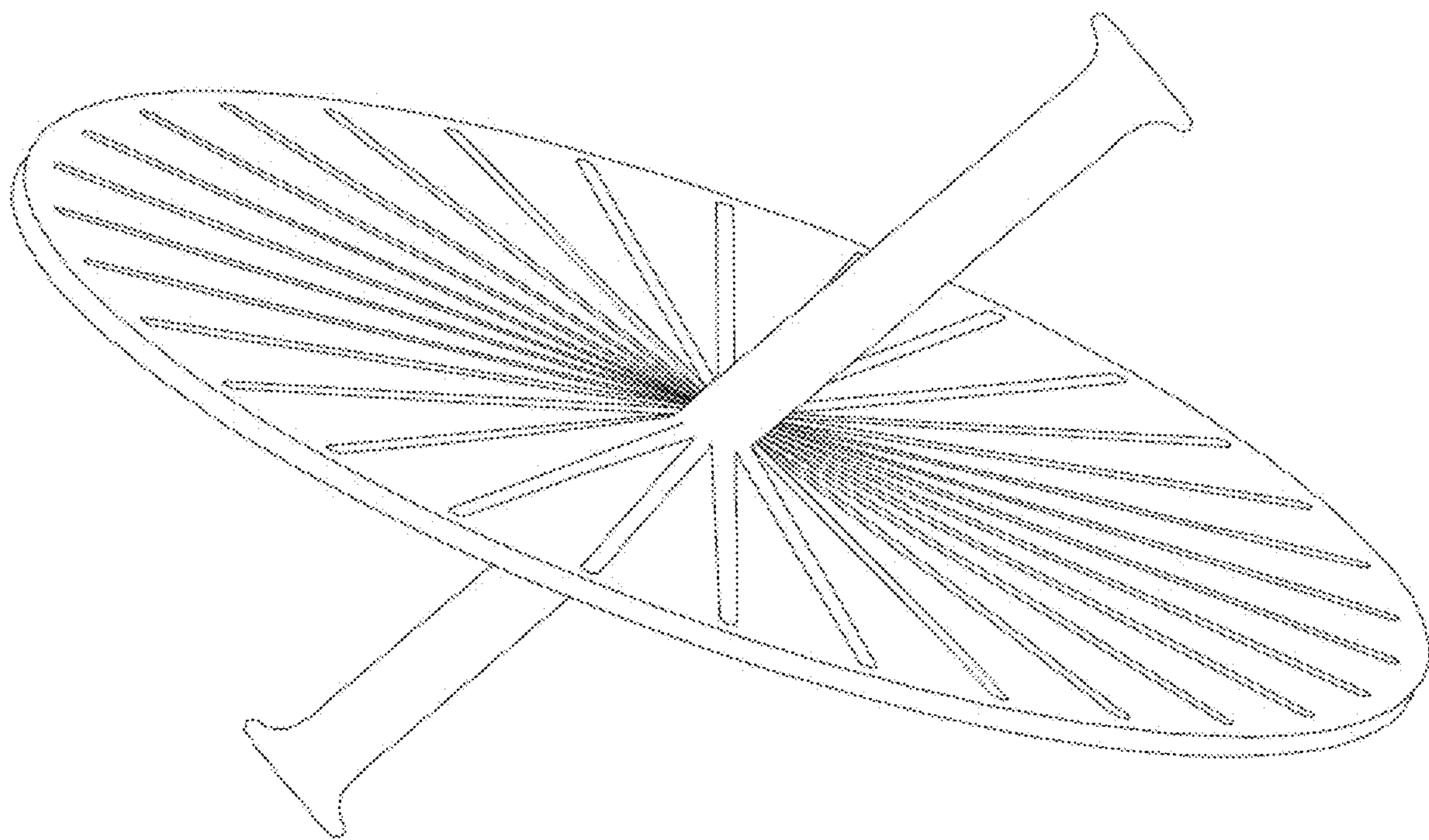

FIG. 1.6

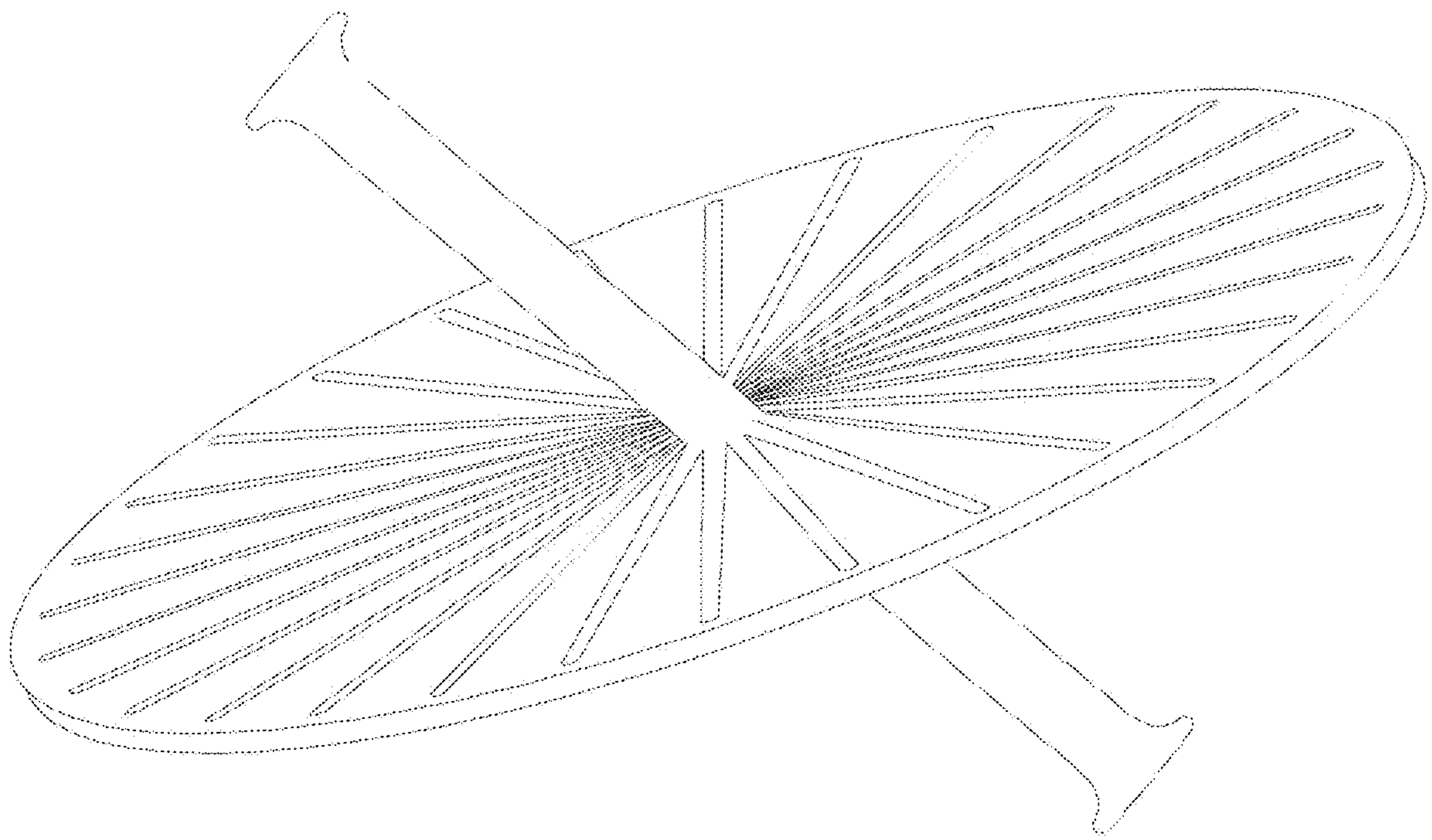

FIG. 1.7