



US00D937042S

(12) **United States Design Patent** (10) **Patent No.:** **US D937,042 S**
Kay (45) **Date of Patent:** **** Nov. 30, 2021**

(54) **CAKE SLICE COVER**

(71) Applicant: **William Kay**, Boca Raton, FL (US)

(72) Inventor: **William Kay**, Boca Raton, FL (US)

(**) Term: **15 Years**

(21) Appl. No.: **29/745,376**

(22) Filed: **Aug. 5, 2020**

(51) **LOC (13) Cl.** **07-07**

(52) **U.S. Cl.**
USPC **D7/610**

(58) **Field of Classification Search**

USPC ... D7/590-596, 600-601, 600.1, 600.3, 602,
D7/610, 614, 701, 597-599, 600.4, 300,
D7/304-306, 311-313, 321, 373, 399,
D7/415, 561, 659, 672-673, 677, 769;
D9/414, 418, 432, 636, 640, 642, 721,
D9/759, 424-425, 430, 773-774, 692;
D23/272, 343, 346; D6/675.1, 682.2,
D6/663-664; D32/55

CPC A47F 10/02; A47F 10/06; A47B 77/022;
A21B 3/00; A21B 3/13

See application file for complete search history.

(56) **References Cited**

U.S. PATENT DOCUMENTS

1,526,397	A *	2/1925	Albin	A21B 3/13
					220/23.2
2,312,046	A *	2/1943	Neilson	A23G 9/26
					249/97
2,682,234	A *	6/1954	Baldanza	A23G 9/26
					249/92
D173,322	S *	10/1954	Patrick	D7/354
D206,338	S *	11/1966	Levin	D7/675
D209,847	S *	1/1968	Taylor	D7/612

(Continued)

FOREIGN PATENT DOCUMENTS

CN	301400834	*	12/2010
KR	301073096.0000	*	9/2020
RU	00058882	*	4/2006

OTHER PUBLICATIONS

Medoro Triangle Cake and Pie Slice Tray, Pastry Chef Central, pastrychef.com, published by Pastry Chef Central on Jan. 6, 2017 © 1996-2021 Amazon.com, Inc., online, site visited Aug. 19, 2021. Available at URL: https://www.pastrychef.com/MEDORO-TRIANGLE-CAKE-PIE-SLICE-TRAYS--DISPOSABLE_p_3203.html (Year: 2017).*

(Continued)

Primary Examiner — Holly E Thurman

Assistant Examiner — Altaira J Swangin

(74) *Attorney, Agent, or Firm* — The Rapacke Law Group PA

(57)

CLAIM

The ornamental design for a cake slice cover, as shown and described.

DESCRIPTION

FIG. 1 is a top perspective view of the cake slice cover, showing the new design;

FIG. 2 is a bottom perspective view of the cake slice cover thereof;

FIG. 3 is a front elevational view of the cake slice cover thereof;

FIG. 4 is a rear elevational view of the cake slice cover thereof;

FIG. 5 is a left side elevational view of the cake slice cover thereof;

FIG. 6 is a right side elevational view of the cake slice cover thereof;

FIG. 7 is a top plan view of the cake slice cover thereof; and,

FIG. 8 is bottom plan view of the cake slice cover thereof.

1 Claim, 5 Drawing Sheets

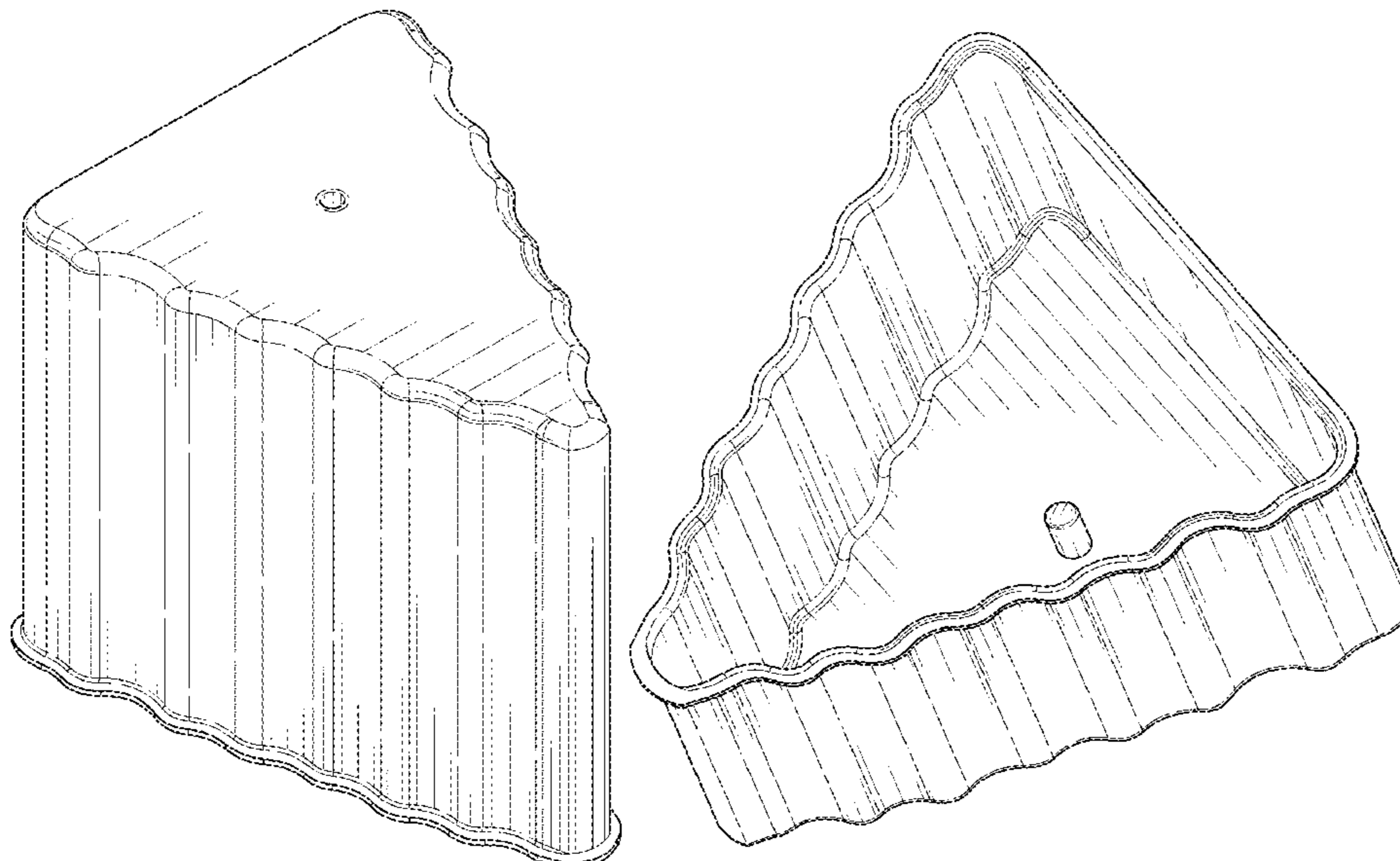

(56)

References Cited

U.S. PATENT DOCUMENTS

3,987,541 A * 10/1976 Sieczkiewicz A21C 15/04
30/114
D249,112 S * 8/1978 Garson D7/354
D264,297 S * 5/1982 Kupperman D1/102
4,373,636 A * 2/1983 Hoffman B65D 1/34
206/545
D295,485 S * 5/1988 Ferrin D7/673
D314,145 S * 1/1991 Niemetz D9/418
5,269,430 A * 12/1993 Schlaupitz B65D 43/162
206/551
D349,050 S * 7/1994 Krupa D9/418
D392,883 S * 3/1998 Ferrin D7/610
D401,582 S * 11/1998 Gremchuck D14/210
D423,930 S * 5/2000 Rondolino D9/430
D425,790 S * 5/2000 Rondolino D9/430
D434,946 S * 12/2000 Jarvis D7/354
D439,161 S * 3/2001 Rondolino D9/430
D439,515 S * 3/2001 Rondolino D9/430
D455,318 S * 4/2002 Miller D7/602
D495,211 S * 8/2004 Brown D7/584
D594,285 S * 6/2009 Merey D7/610
D628,862 S * 12/2010 Zeilinger D7/675
D758,503 S * 6/2016 Sorensen D21/505
D840,757 S * 2/2019 Peterson D7/543
D874,881 S * 2/2020 Mastronardi D7/628

OTHER PUBLICATIONS

Cake Shield, Top It Cake Shield, pastrychef.com, published by
Nicholaus Li on Oct. 20, 2020 © 2021 HypeBeast Ltd., online, site
visited Aug. 19, 2021. Available at URL: [https://hypebeast.com/
2020/10/top-it-cake-shield-coronavirus-birthday-buy](https://hypebeast.com/2020/10/top-it-cake-shield-coronavirus-birthday-buy) (Year: 2020).*

* cited by examiner

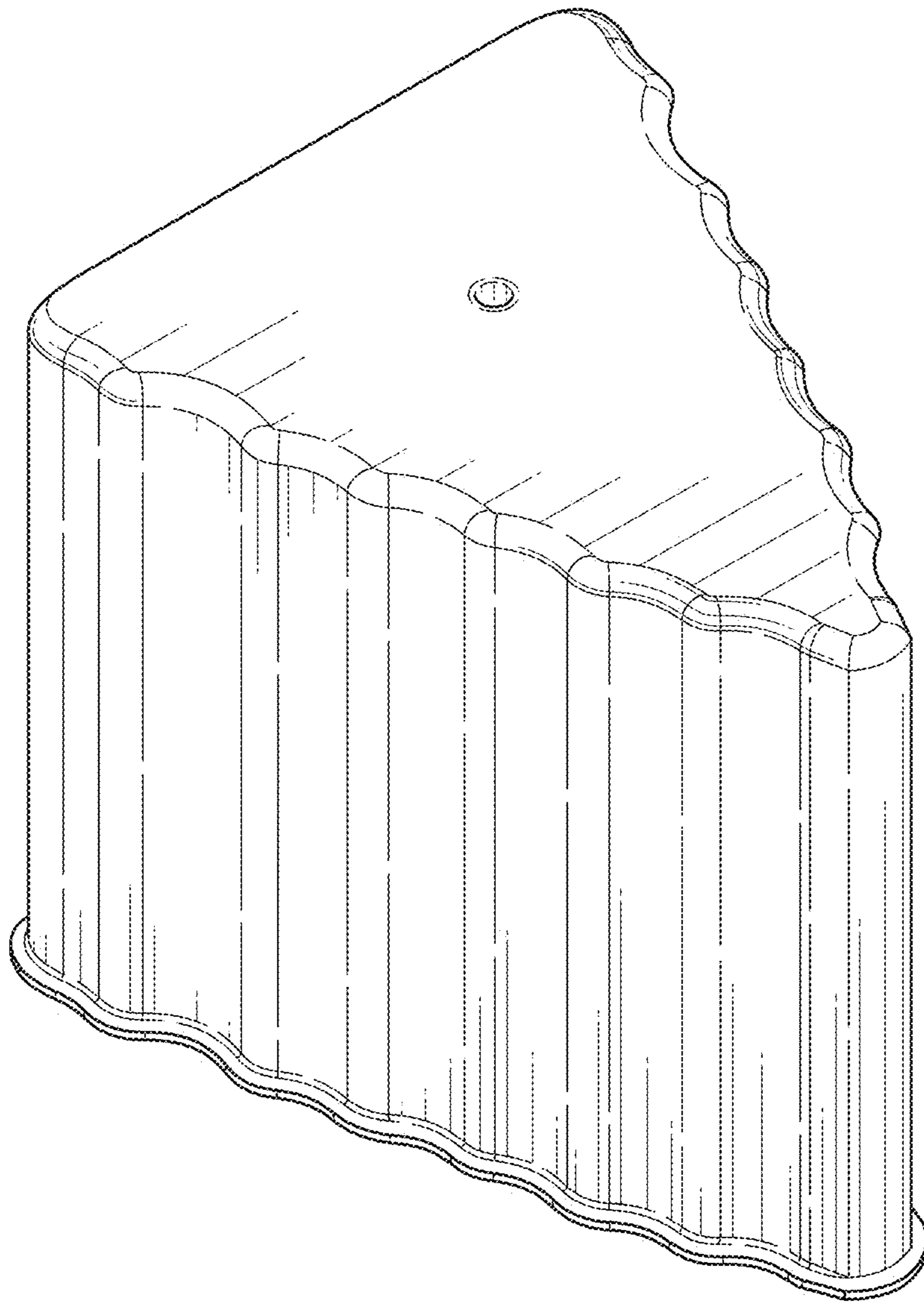

FIG. 1

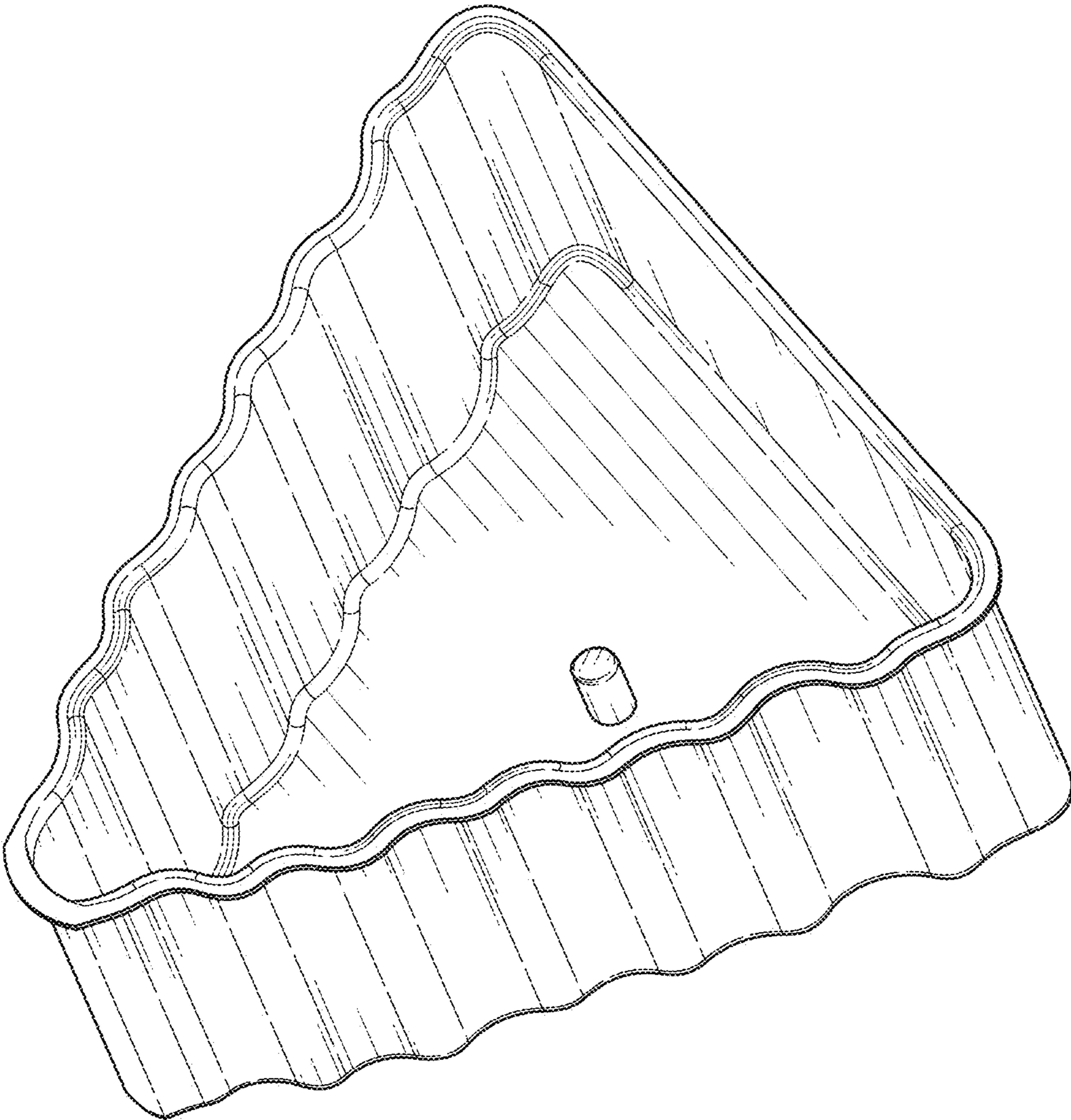

FIG. 2

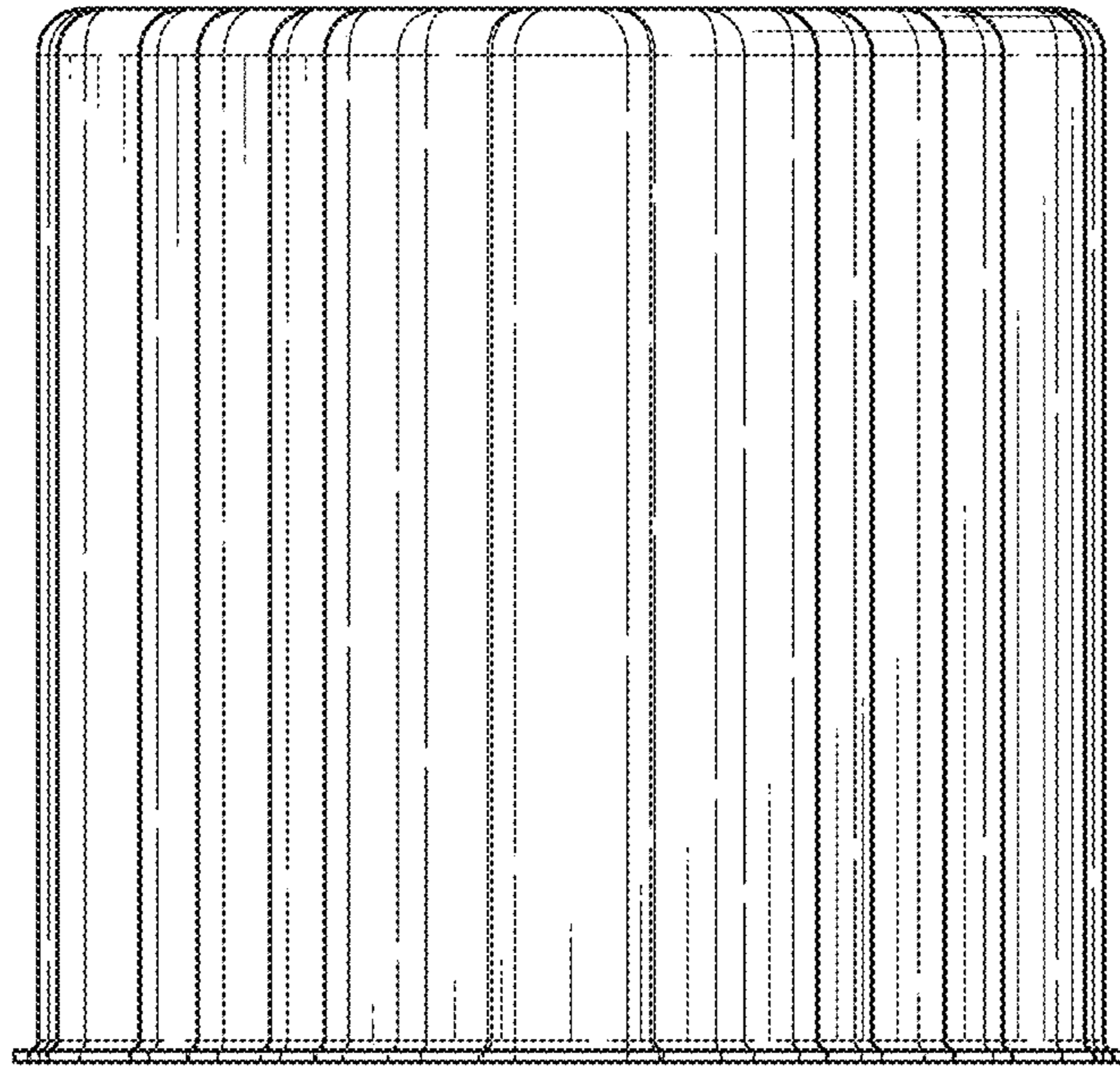

FIG. 3

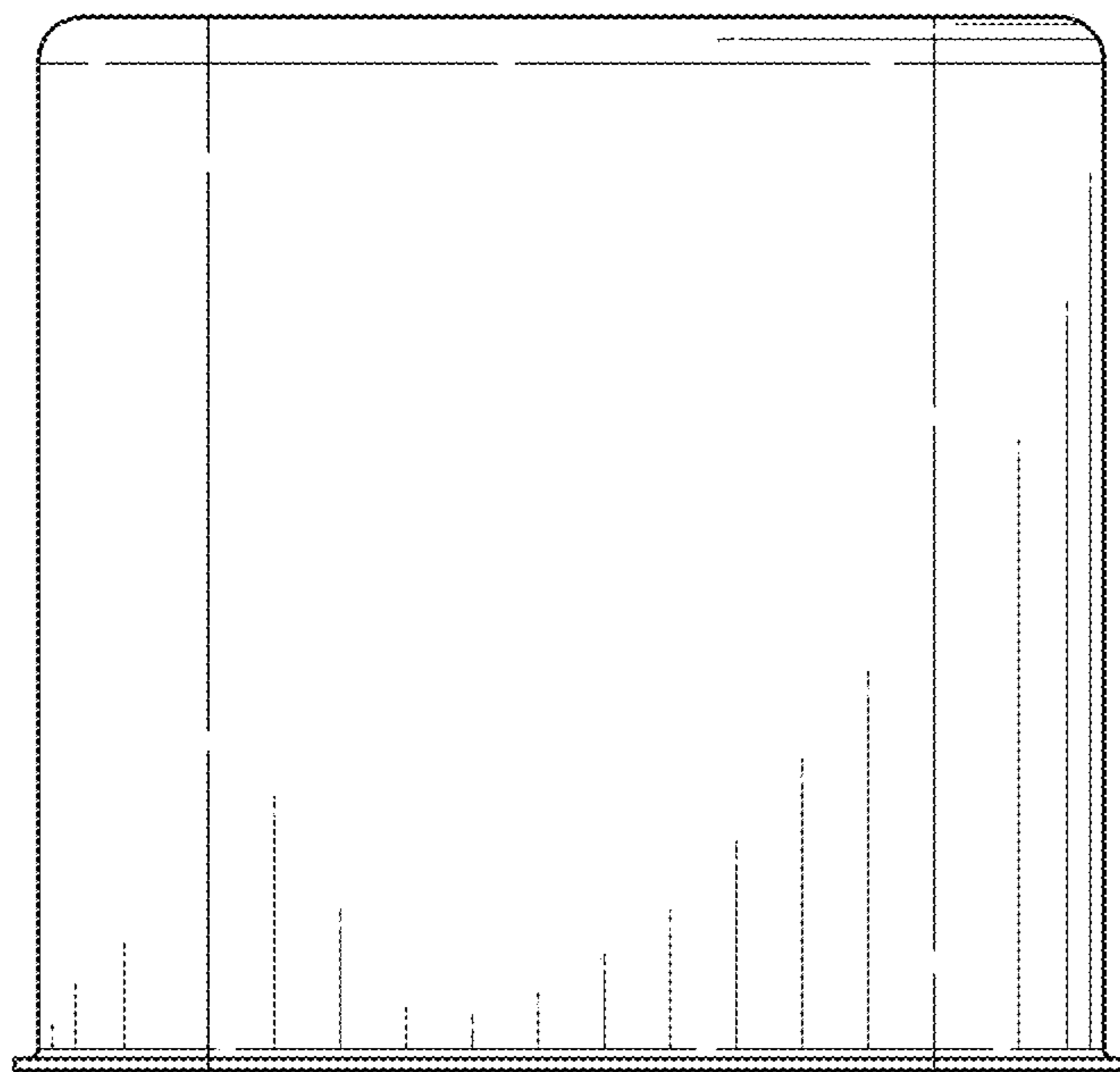

FIG. 4

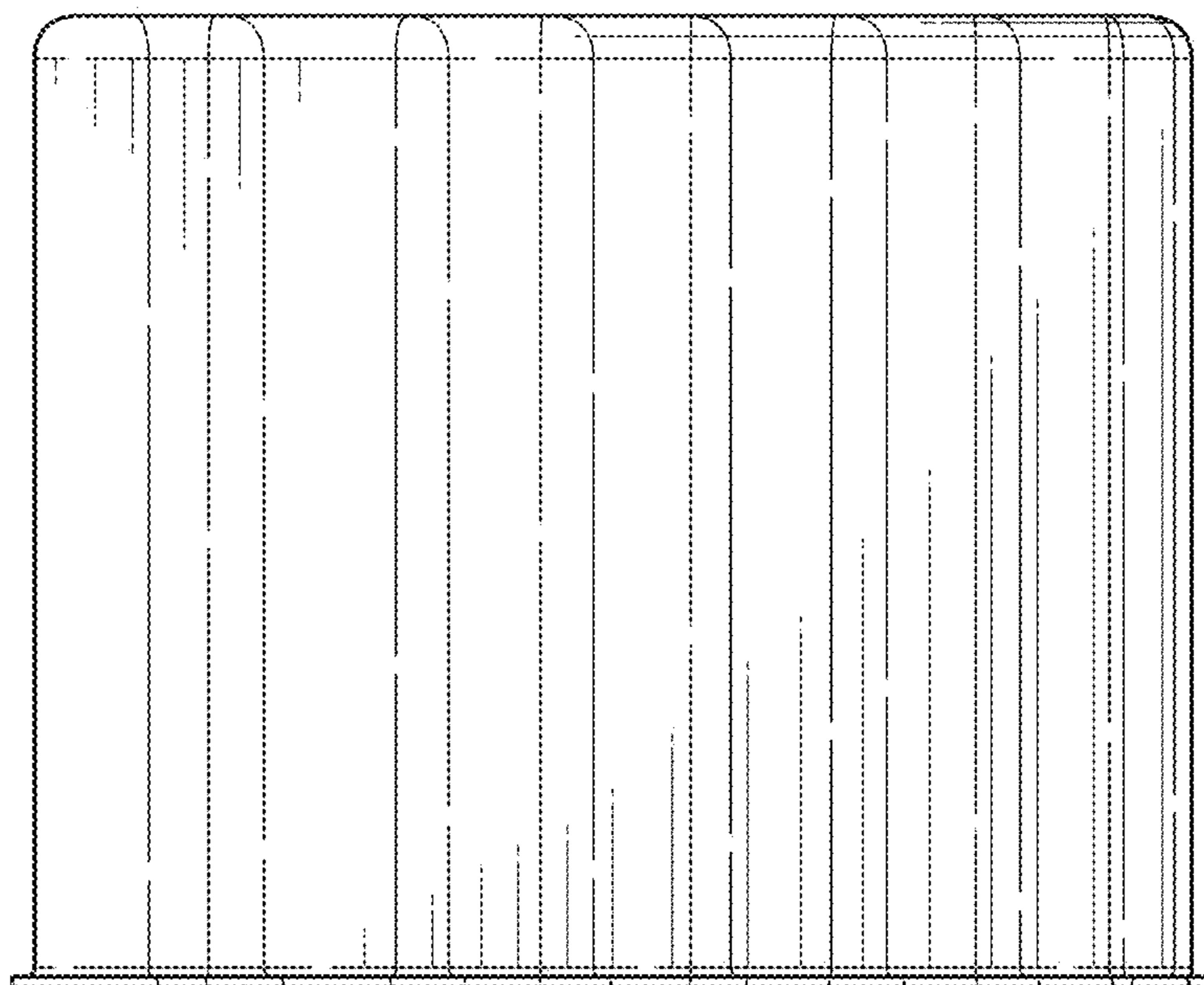

FIG. 5

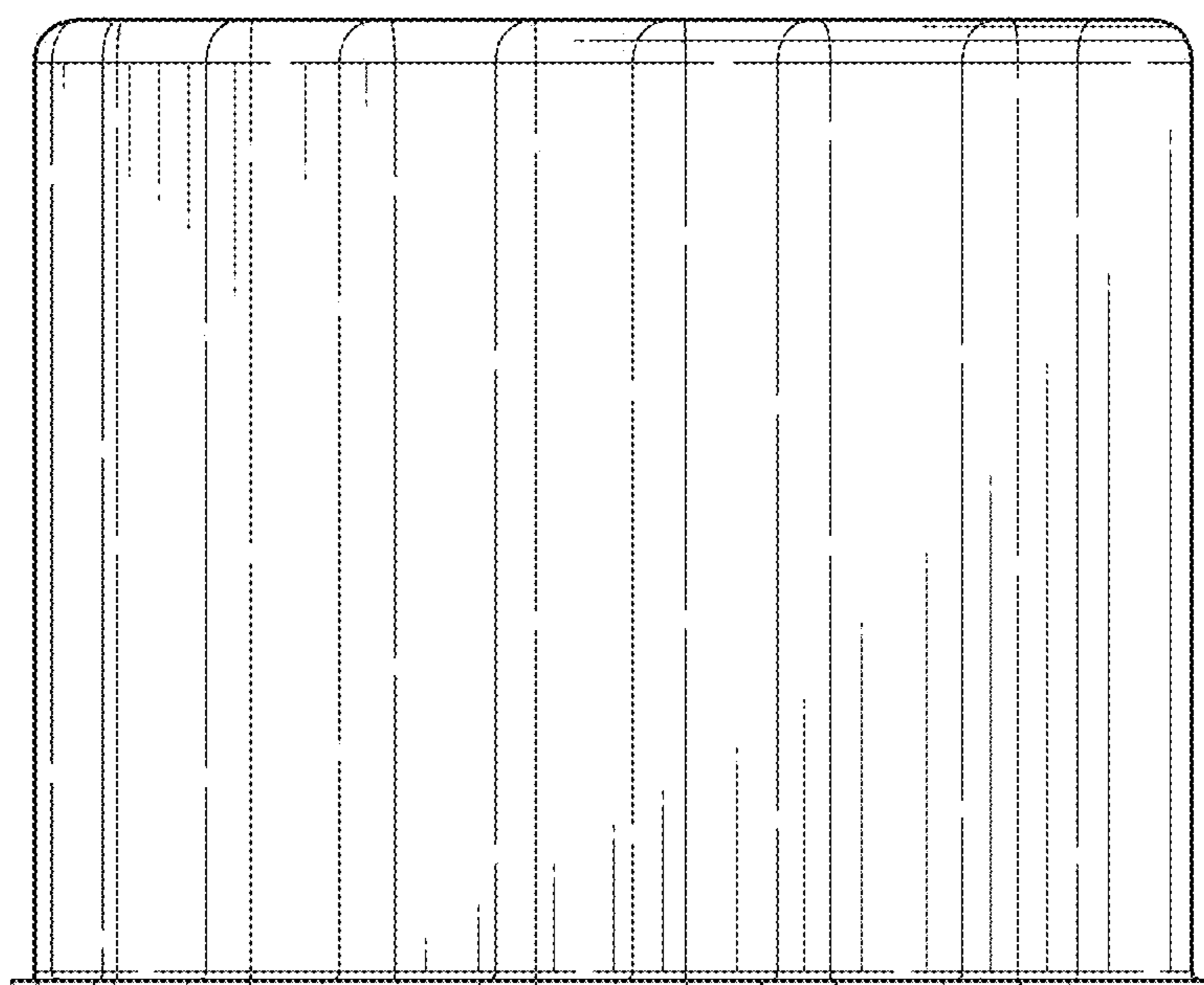

FIG. 6

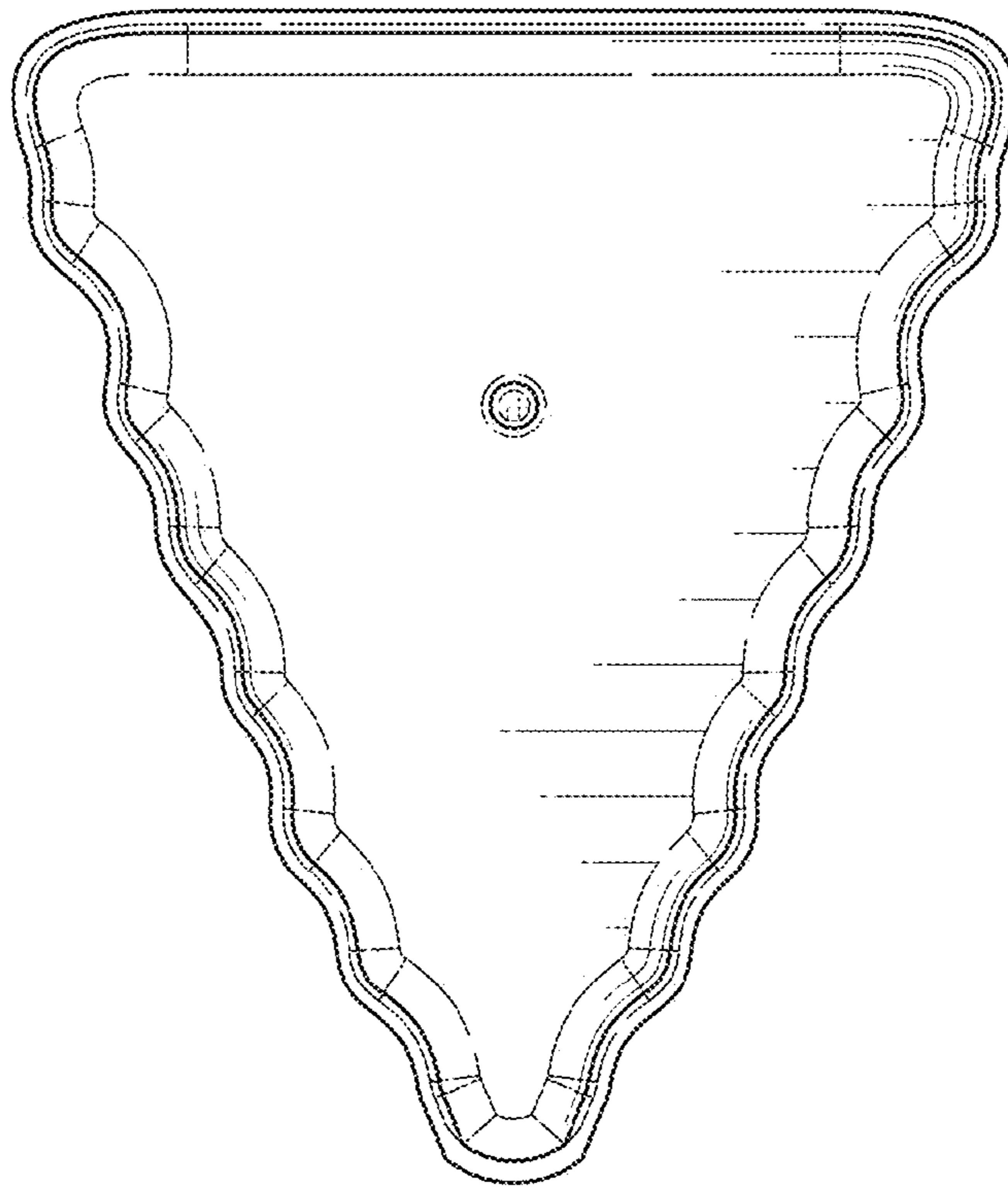

FIG. 7

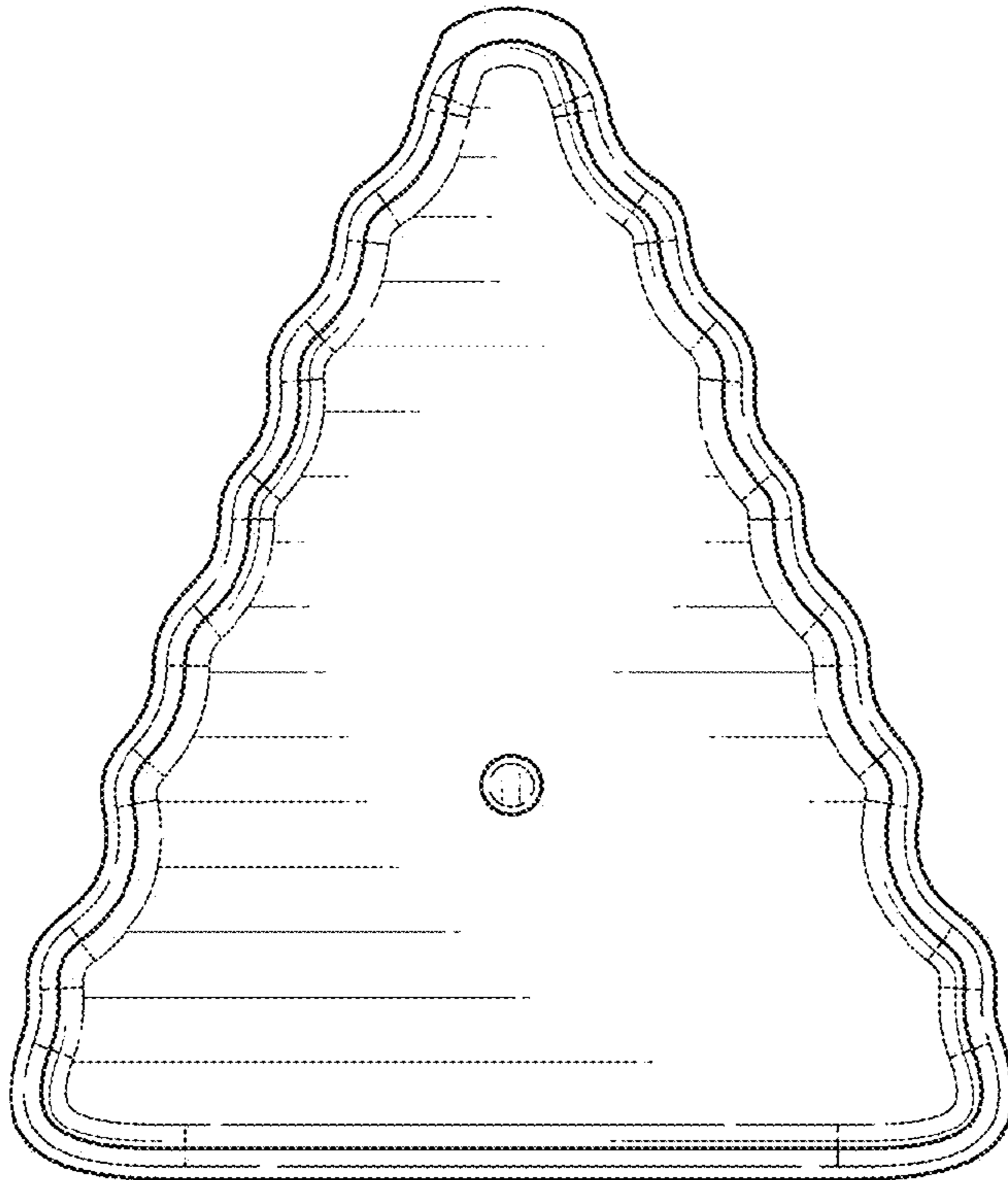

FIG. 8