



US00D936997S

(12) **United States Design Patent**
Li

(10) **Patent No.:** **US D936,997 S**

(45) **Date of Patent:** **** Nov. 30, 2021**

(54) **PORTABLE TABLE**

(71) Applicant: **SHENZHEN LEADERMENT TECHNOLOGY CO., LTD.**, Shenzhen (CN)

(72) Inventor: **Chunbin Li**, Shenzhen (CN)

(73) Assignee: **SHENZHEN LEADERMENT TECHNOLOGY CO., LTD.**, Shenzhen (CN)

(**) Term: **15 Years**

(21) Appl. No.: **29/743,147**

(22) Filed: **Jul. 20, 2020**

(51) **LOC (13) Cl.** **06-06**

(52) **U.S. Cl.**
USPC **D6/406.6**

(58) **Field of Classification Search**
USPC D6/406.1–406.6, 421–422; D19/91–92; D7/552.2, 554.3–554.4
CPC A47G 23/00; A47G 23/06; A47G 23/0608; A47G 23/08; A47G 23/0625; A47B 3/002; A47B 3/02; A47B 2003/008; A47B 17/00; A47B 21/00; A47B 21/04; A47B 23/00; A47B 23/001; A47B 23/002; A47B 2023/049

See application file for complete search history.

(56) **References Cited**

U.S. PATENT DOCUMENTS

D152,153 S * 12/1948 Harvey D6/349
D319,358 S * 8/1991 Giugiaro D6/406.6

D373,198 S * 8/1996 Hill D24/230
D385,126 S * 10/1997 Howland D6/406.6
D390,718 S * 2/1998 Howland D6/406.6
D404,219 S * 1/1999 Patterson D6/406.6
D428,729 S * 8/2000 Weitzman D6/406.5
8,261,920 B1 * 9/2012 Matthews A47K 1/09
211/90.01
D723,830 S * 3/2015 Tcholakov D6/406.6
9,578,960 B1 * 2/2017 Wu A47B 23/04
D802,379 S * 11/2017 Raphael D7/698
D840,708 S * 2/2019 Melaragno D6/406.5
D880,913 S * 4/2020 Kuo D6/705
D910,645 S * 2/2021 Lyu D14/451

* cited by examiner

Primary Examiner — Kelley A Donnelly

(74) *Attorney, Agent, or Firm* — Law Offices of Steven W. Weinrieb

(57) **CLAIM**

The ornamental design for a portable table, as shown and described.

DESCRIPTION

FIG. 1 is a front, right side, top perspective view of a portable table showing my new design; FIG. 2 is a rear, right side, bottom perspective view thereof; FIG. 3 is a front elevational view thereof; FIG. 4 is a rear elevational view thereof; FIG. 5 is a left side elevational view thereof; FIG. 6 is a right side elevational view thereof; FIG. 7 is a top plan view thereof; and, FIG. 8 is a bottom plan view thereof. The broken lines depict portions of the portable table that form no part of the claimed design.

1 Claim, 8 Drawing Sheets

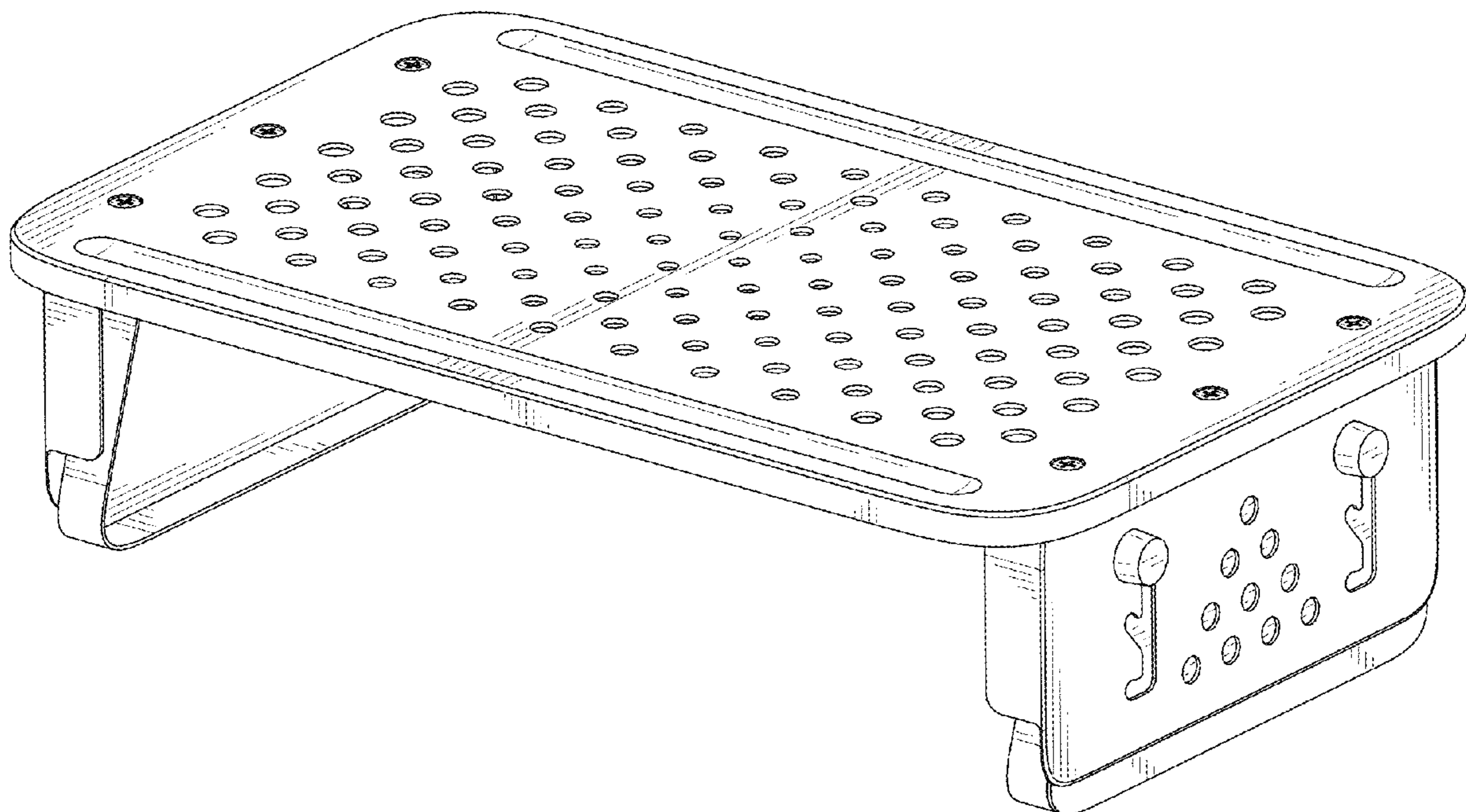

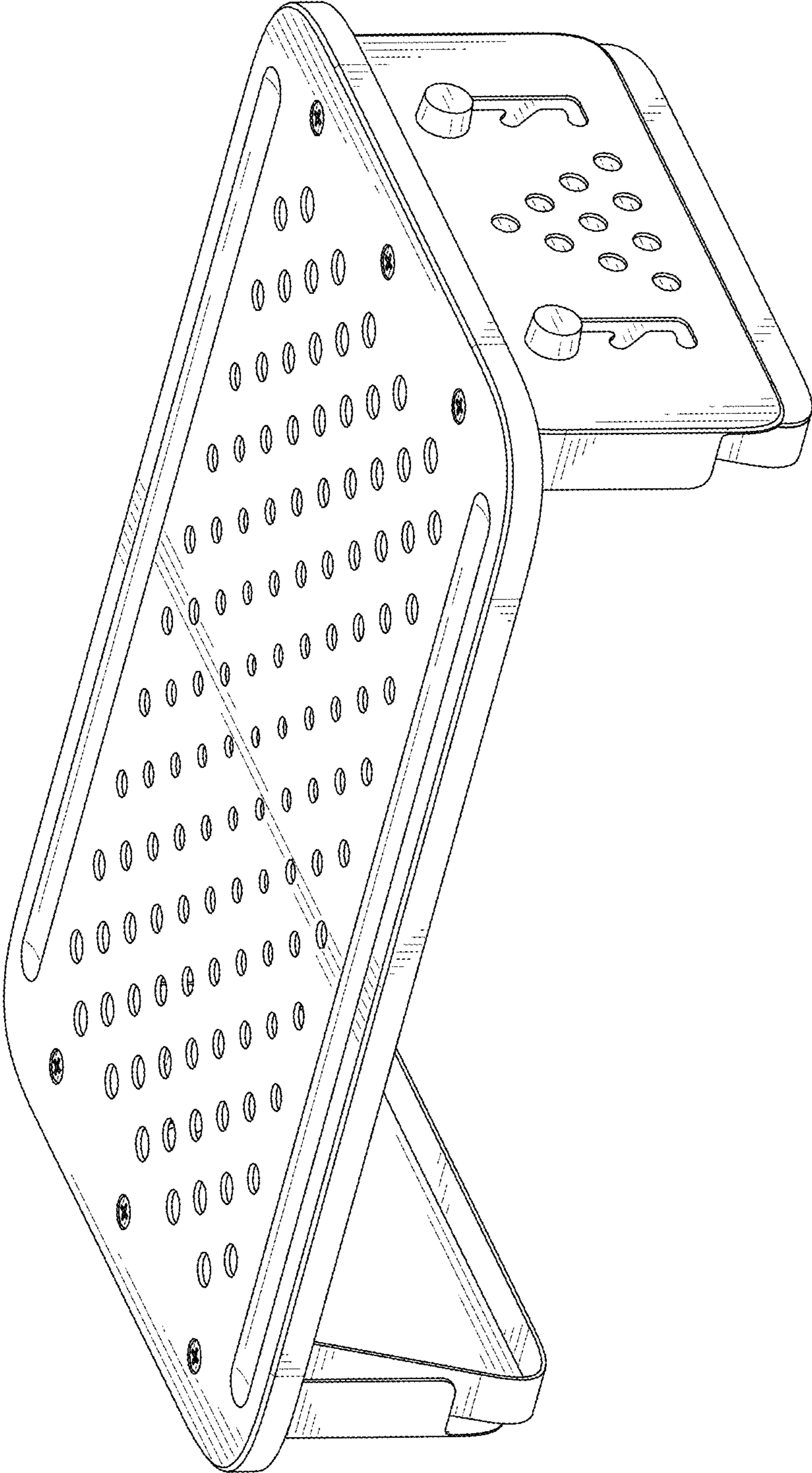

FIG.1

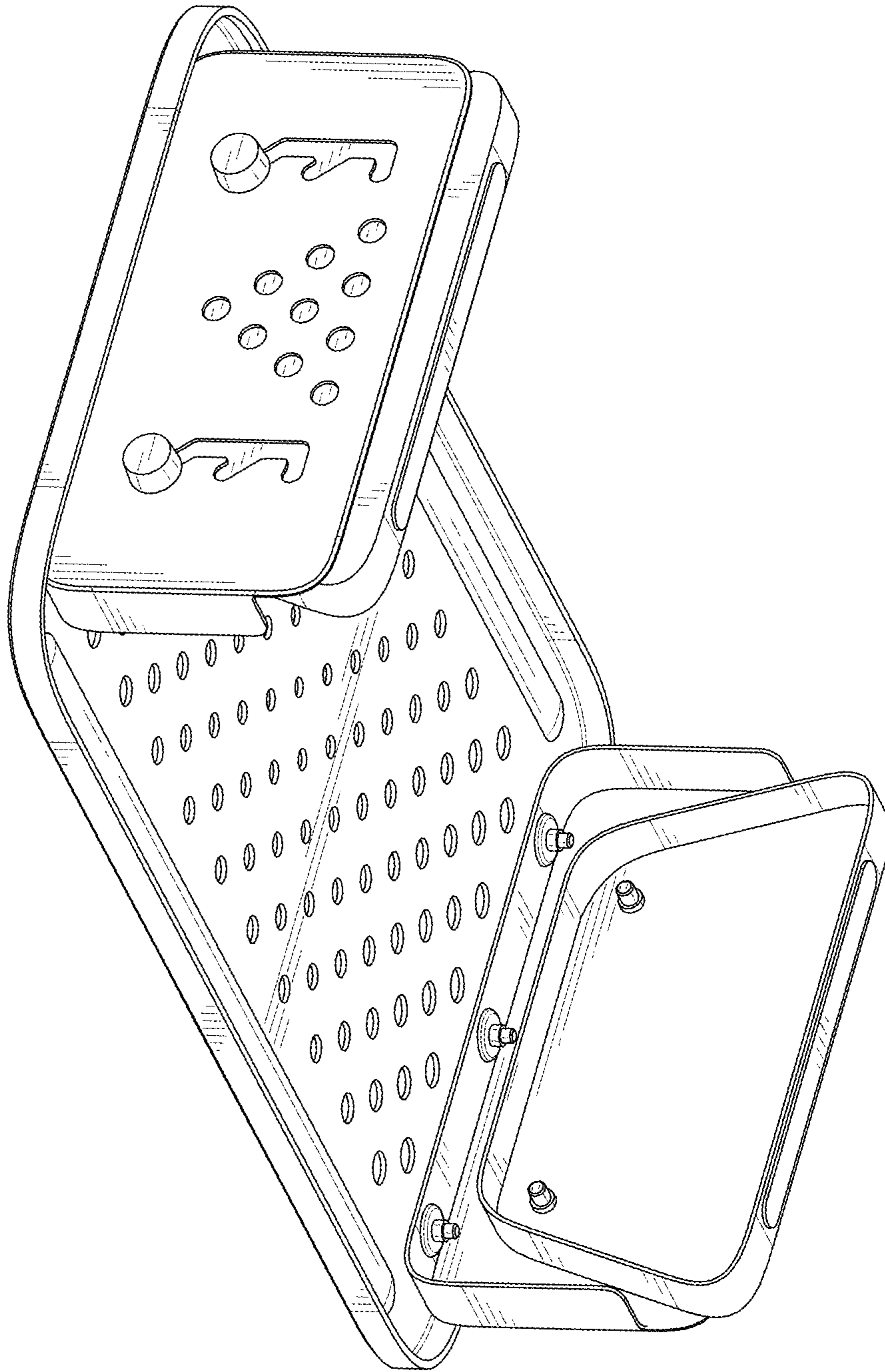

FIG. 2

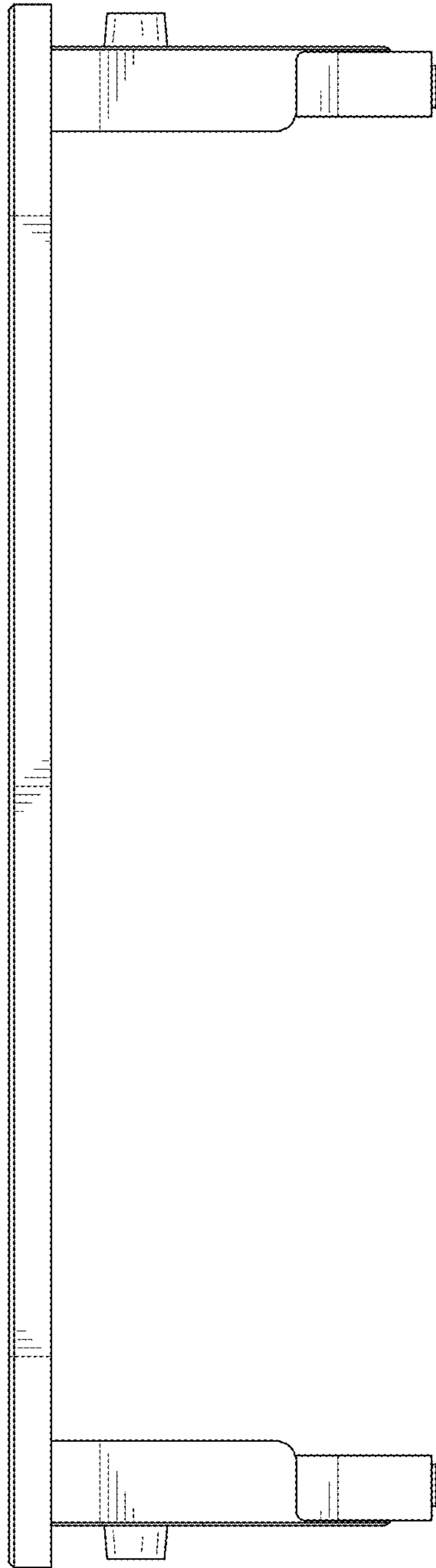

FIG. 3

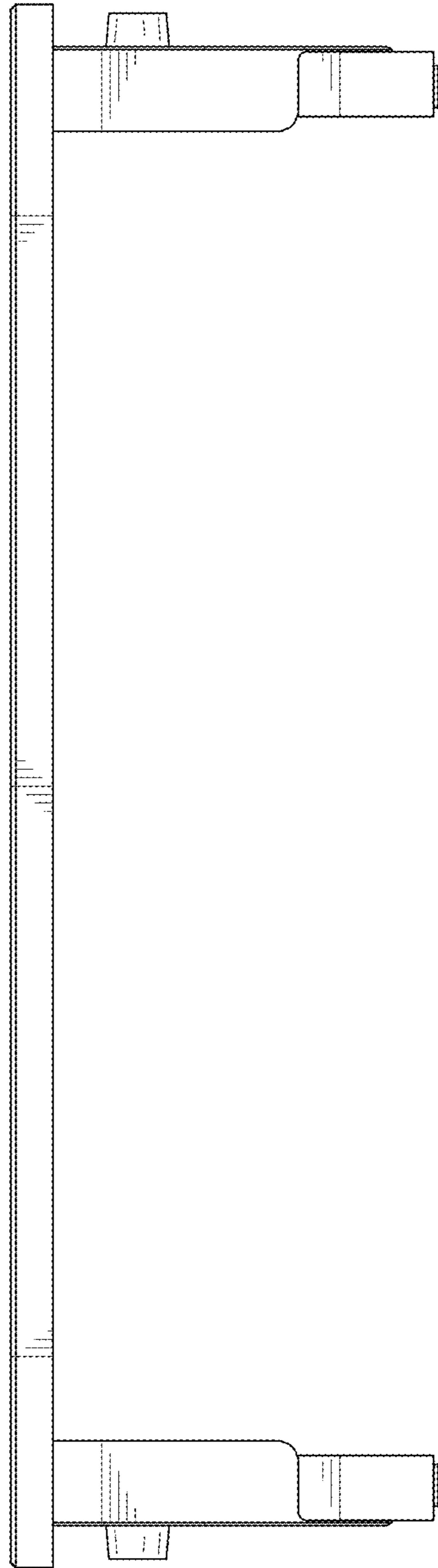

FIG. 4

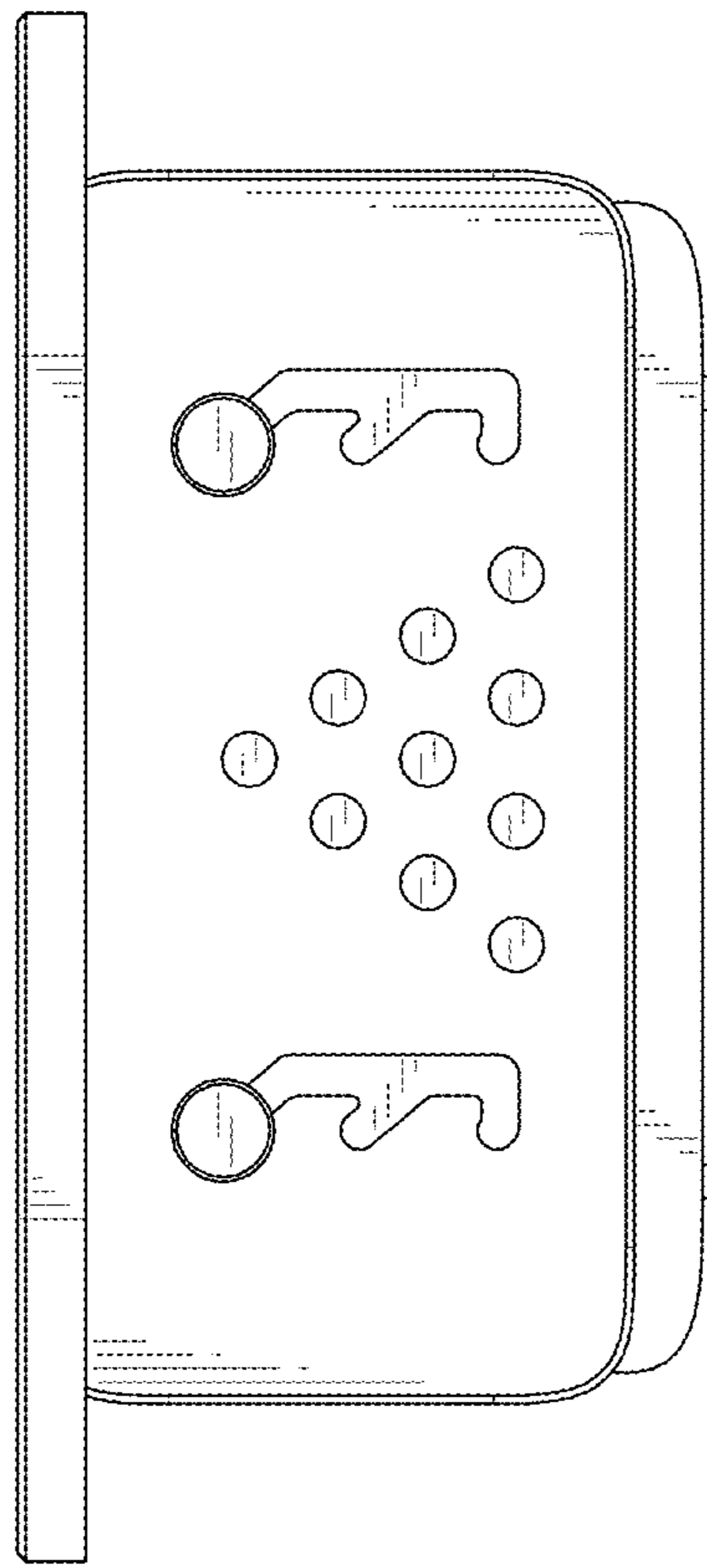

FIG. 5

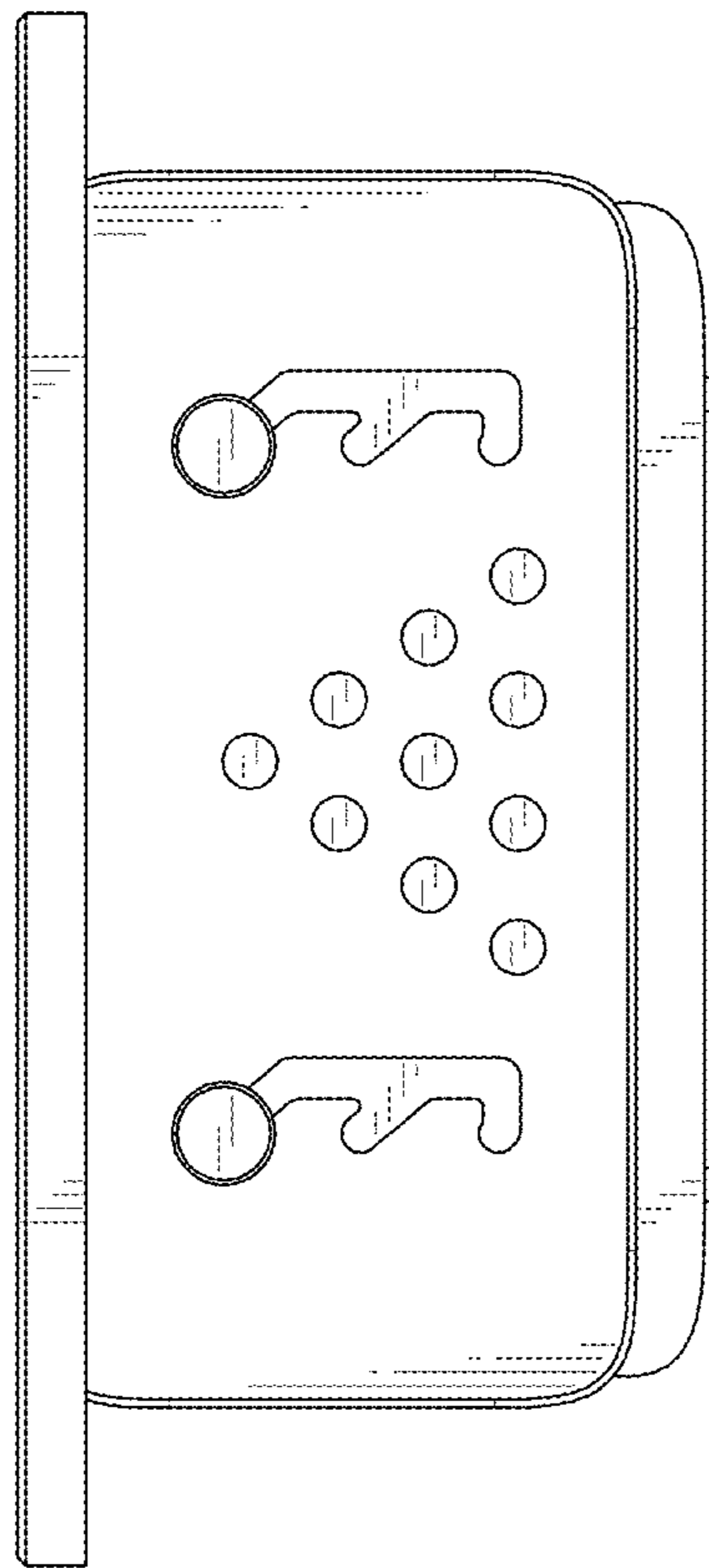

FIG.6

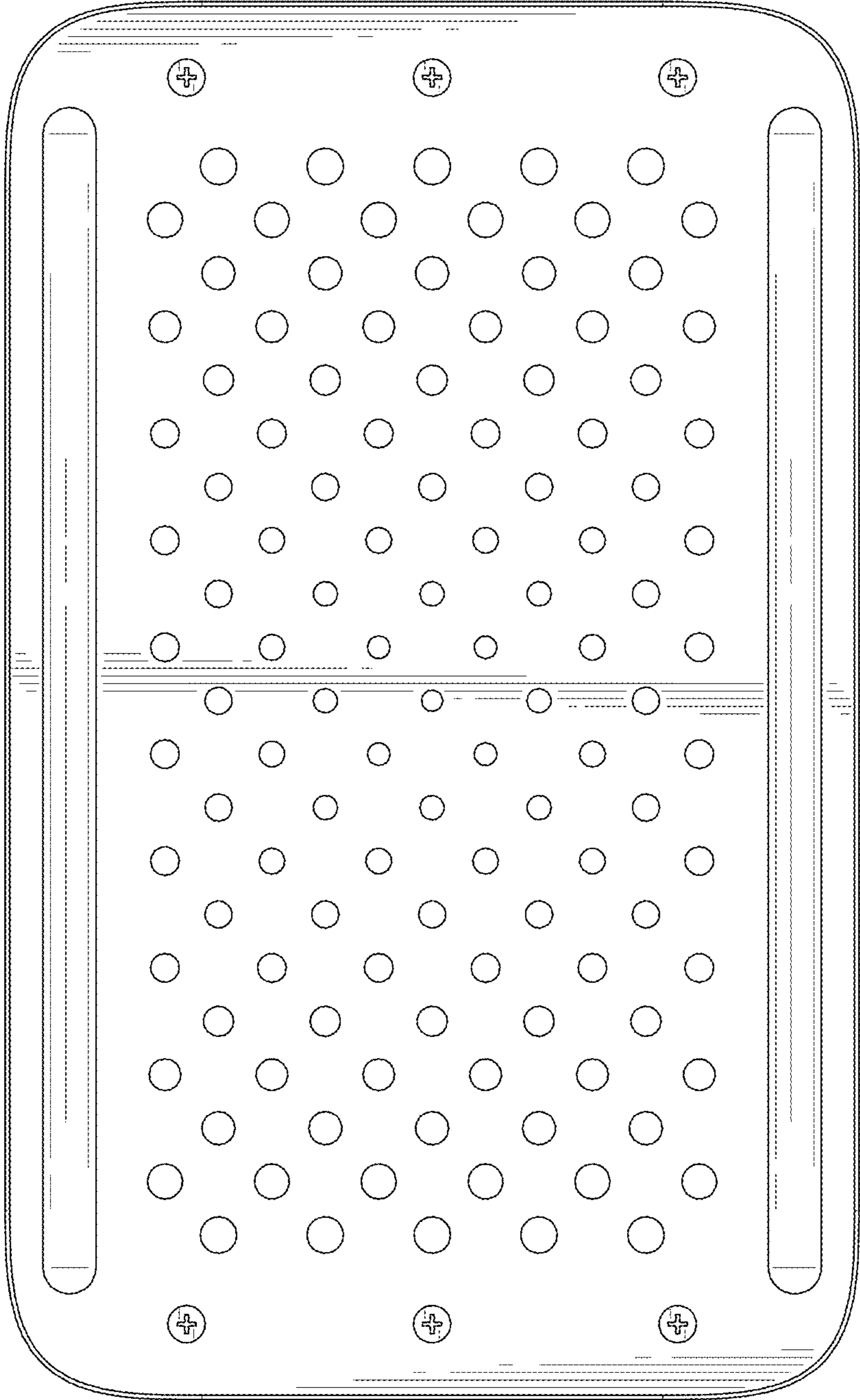

FIG. 7

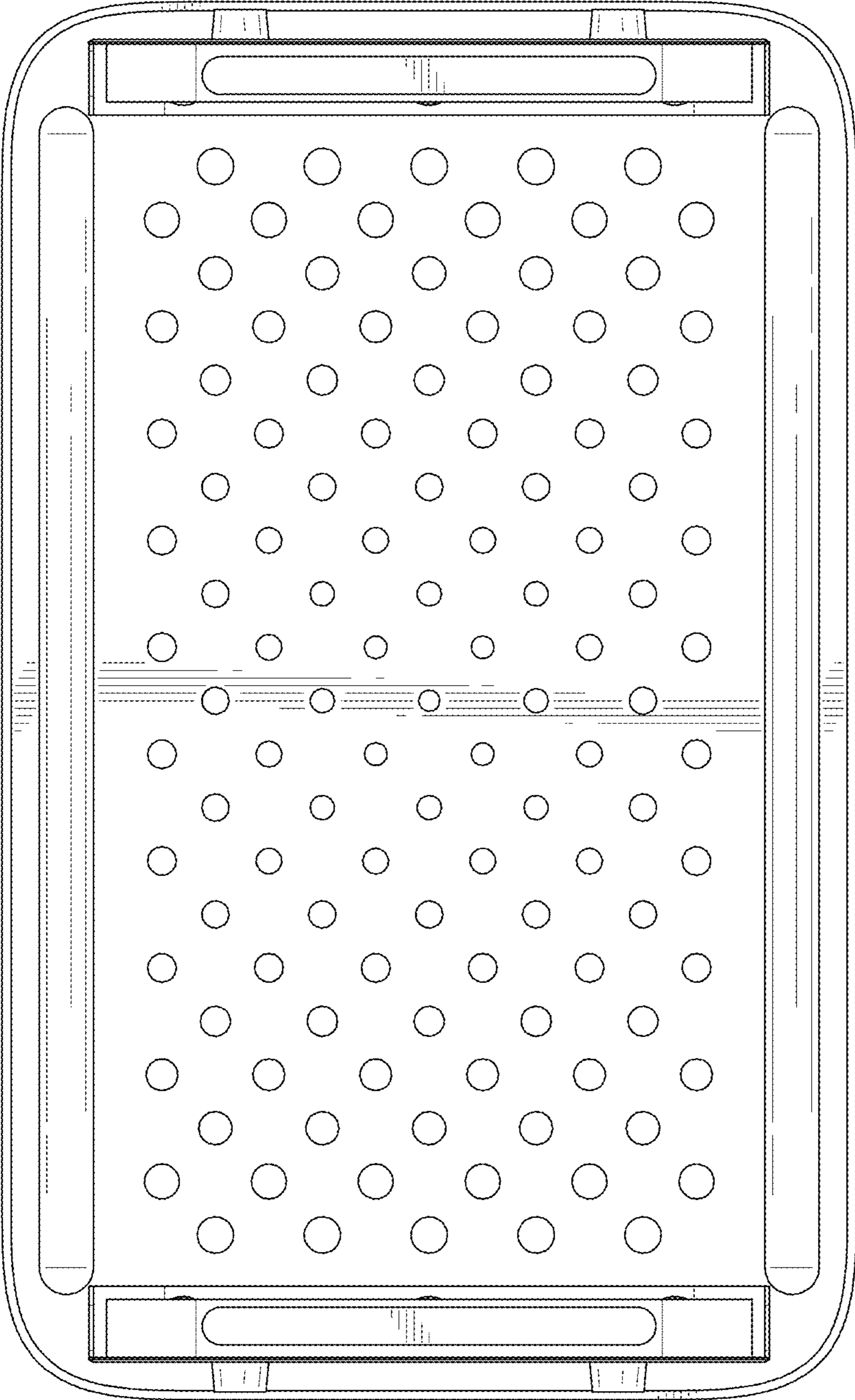

FIG. 8