

US00D936996S

(12) **United States Design Patent**
Van Staveren

(10) **Patent No.:** **US D936,996 S**

(45) **Date of Patent:** **** Nov. 30, 2021**

(54) **FOLDABLE BABY BED**

(71) Applicant: **Xplorys Holding B.V.**, Broek op Langedijk (NL)

(72) Inventor: **Andy Van Staveren**, Broek op Langedijk (NL)

(**) Term: **15 Years**

(21) Appl. No.: **35/509,628**

(22) Filed: **Dec. 31, 2019**

(80) **Hague Agreement Data**

Int. Filing Date: **Dec. 31, 2019**

Int. Reg. No.: **DM/208593**

Int. Reg. Date: **Dec. 31, 2019**

Int. Reg. Pub. Date: **Jun. 19, 2020**

(51) **LOC (13) Cl.** **06-02**

(52) **U.S. Cl.**
USPC **D6/391**

(58) **Field of Classification Search**
USPC D3/213, 231, 232, 233, 243, 900;
D6/383, 391
CPC . A47D 7/00; A47D 7/002; A47D 9/00; A47D
13/066
See application file for complete search history.

(56) **References Cited**

U.S. PATENT DOCUMENTS

1,760,681 A * 5/1930 Barol A45C 3/06
150/107
2,345,295 A * 3/1944 Schettler, Jr. A47D 9/005
5/98.1
2,502,486 A * 4/1950 Savrin A47D 9/005
190/1
2,587,255 A * 2/1952 Vogel A47D 9/005
5/98.3

2,949,628 A * 8/1960 Koltun A47D 7/002
16/335
3,489,194 A * 1/1970 Hoover A45C 9/00
383/4
4,499,619 A * 2/1985 Kassai A47D 7/002
16/360

(Continued)

OTHER PUBLICATIONS

4-in-1 Convertible Baby Diaper Bag, posted at Amazon.com, posted on Sep. 19, 2019, site visited May 14, 2021. online, available from internet: <https://www.amazon.com/Convertible-Baby-Diaper-Bag-Multi-Purpose/dp/B07TW2H148> (Year: 2019).*

(Continued)

Primary Examiner — Mary Ann Calabrese

Assistant Examiner — Catherine Ho

(57) **CLAIM**

The ornamental design for a foldable baby bed, as shown and described.

DESCRIPTION

FIG. 1.12 is a front side view of a foldable baby bed, showing my new design in an open configuration;
FIG. 1.13 is a top front and right side perspective view thereof;
FIG. 1.14 is a back side view thereof;
FIG. 1.15 is a top view thereof;
FIG. 1.16 is a right side view thereof;
FIG. 1.17 is a left side view thereof;
FIG. 1.18 is a bottom view thereof;
FIG. 1.19 is a top view of a foldable baby bed shown in a closed configuration;
FIG. 1.20 is a right side view thereof;
FIG. 1.21 is a bottom view thereof;
FIG. 1.22 is a left side view thereof;
FIG. 1.23 is a front side view thereof;
FIG. 1.24 is a back side view thereof; and
FIG. 1.25 is a top front and left perspective view thereof.

(Continued)

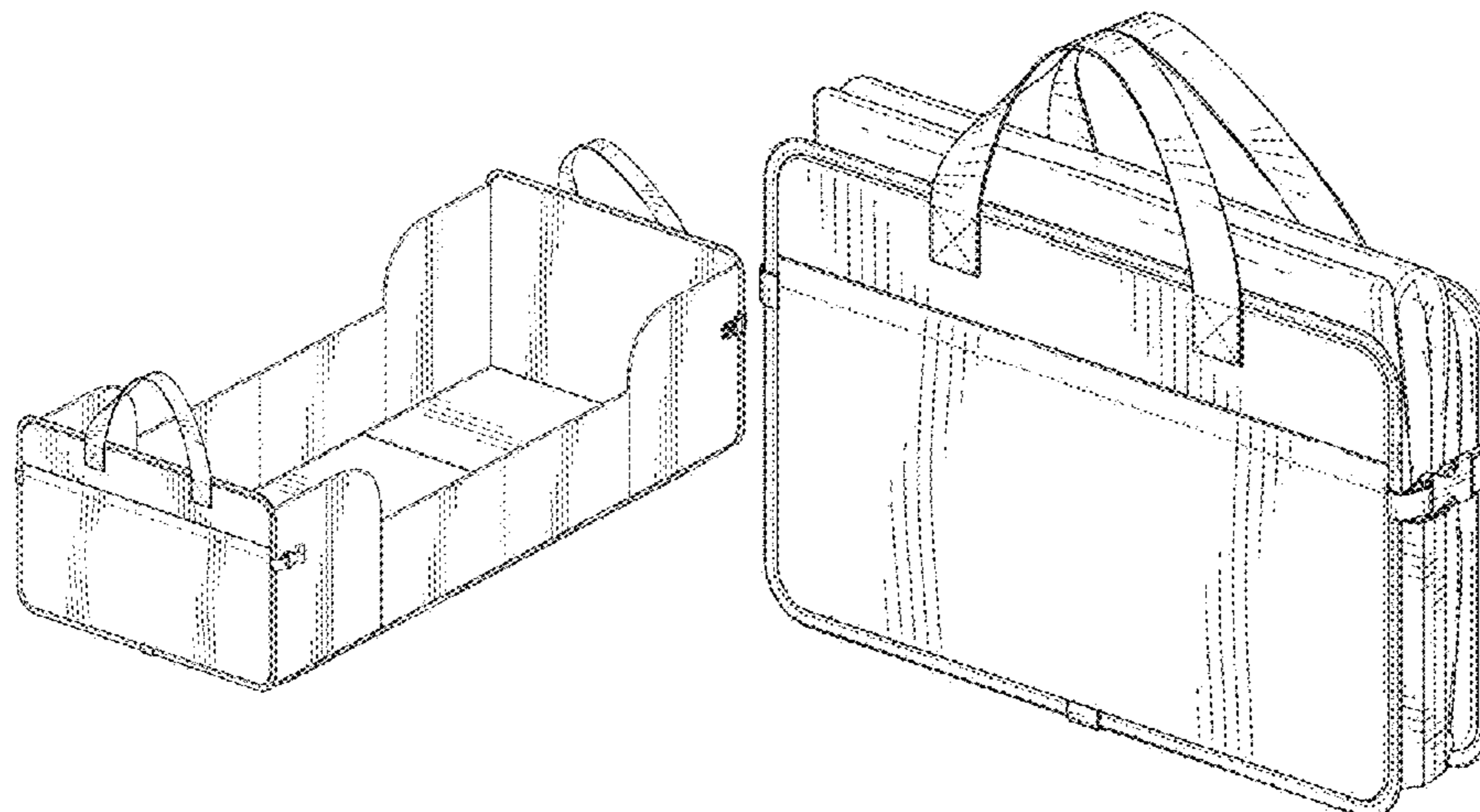

The broken line portions of FIGS. 1.12-1.25 shown with dashes of even length illustrate unclaimed stitching.

1 Claim, 14 Drawing Sheets

D905,959	S *	12/2020	Lee	D3/243
D906,672	S *	1/2021	Wu	D3/287
D909,772	S *	2/2021	Lu	D6/331
2010/0288591	A1*	11/2010	Drew	A45C 3/02 190/109
2015/0113729	A1*	4/2015	Paterson	A47D 7/02 5/98.1

(56)

References Cited

U.S. PATENT DOCUMENTS

4,683,600	A *	8/1987	Beger	A47D 7/002 5/99.1
4,999,863	A *	3/1991	Kane	A45C 9/00 190/2
D324,970	S *	3/1992	Kane	D6/595
6,370,715	B1*	4/2002	Morton	A47D 7/002 5/655
6,687,928	B1*	2/2004	Wilson	A47D 7/002 403/59
D886,449	S *	6/2020	Seo	D3/232

OTHER PUBLICATIONS

Infant Baby Travel Bag, posted at Amazon.com, posted on Mar. 15, 2019, site visited May 14, 2021. online, available from internet: <https://www.amazon.com/Laluka-Travel-Bassinet-Portable-Baby/dp/B07WMP1HVV> (Year: 2019).*

Multi-Purpose Travel Baby Diaper Bag, posted at Amazon.com, posted on Mar. 13, 2021, site visited May 14, 2021. online, available from internet: <https://www.amazon.com/Multi-Purpose-Maternity-Backpack-Changing-Capacity/dp/B08S7CQPJF> (Year: 2021).*

* cited by examiner

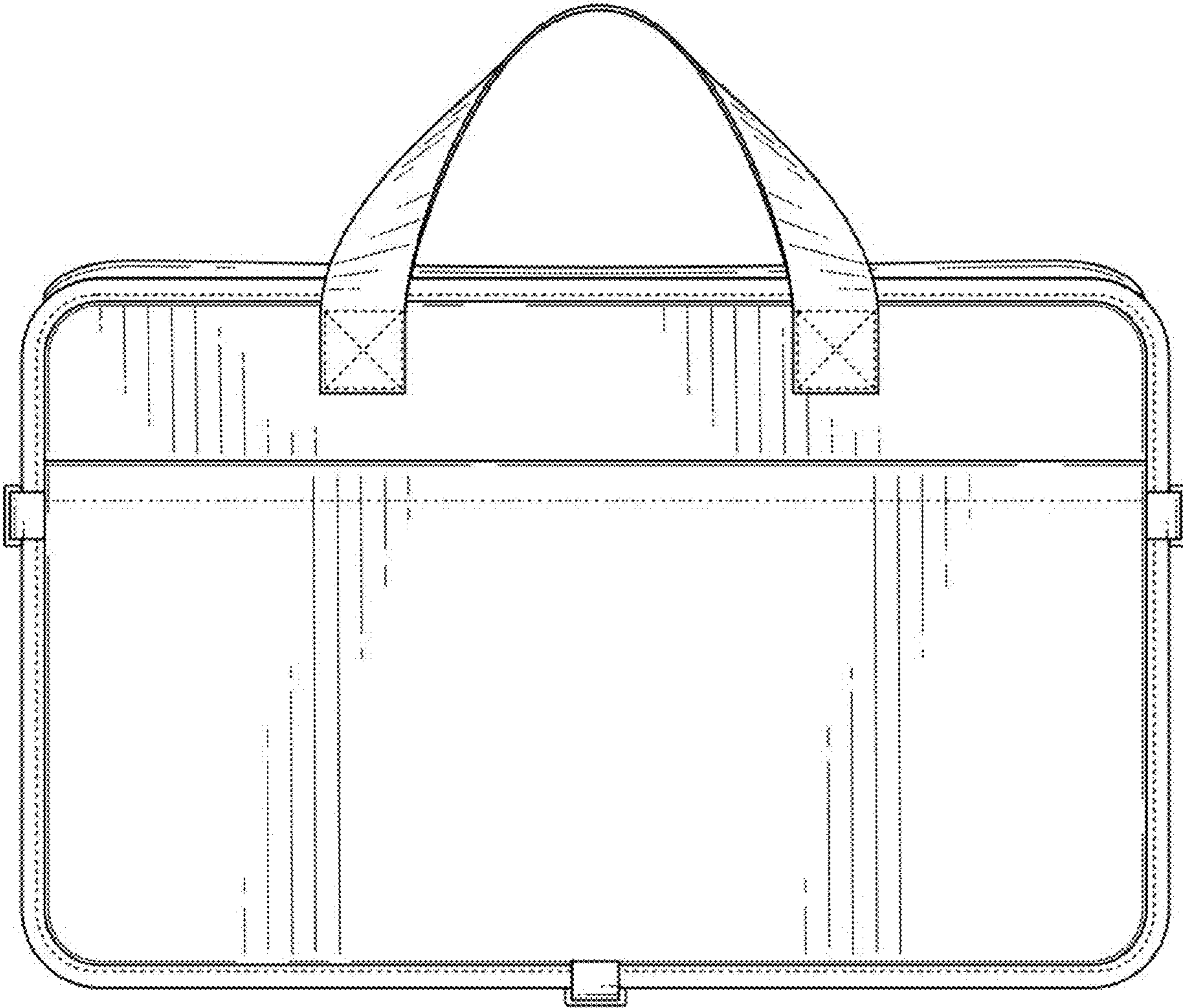

FIG. 1.12

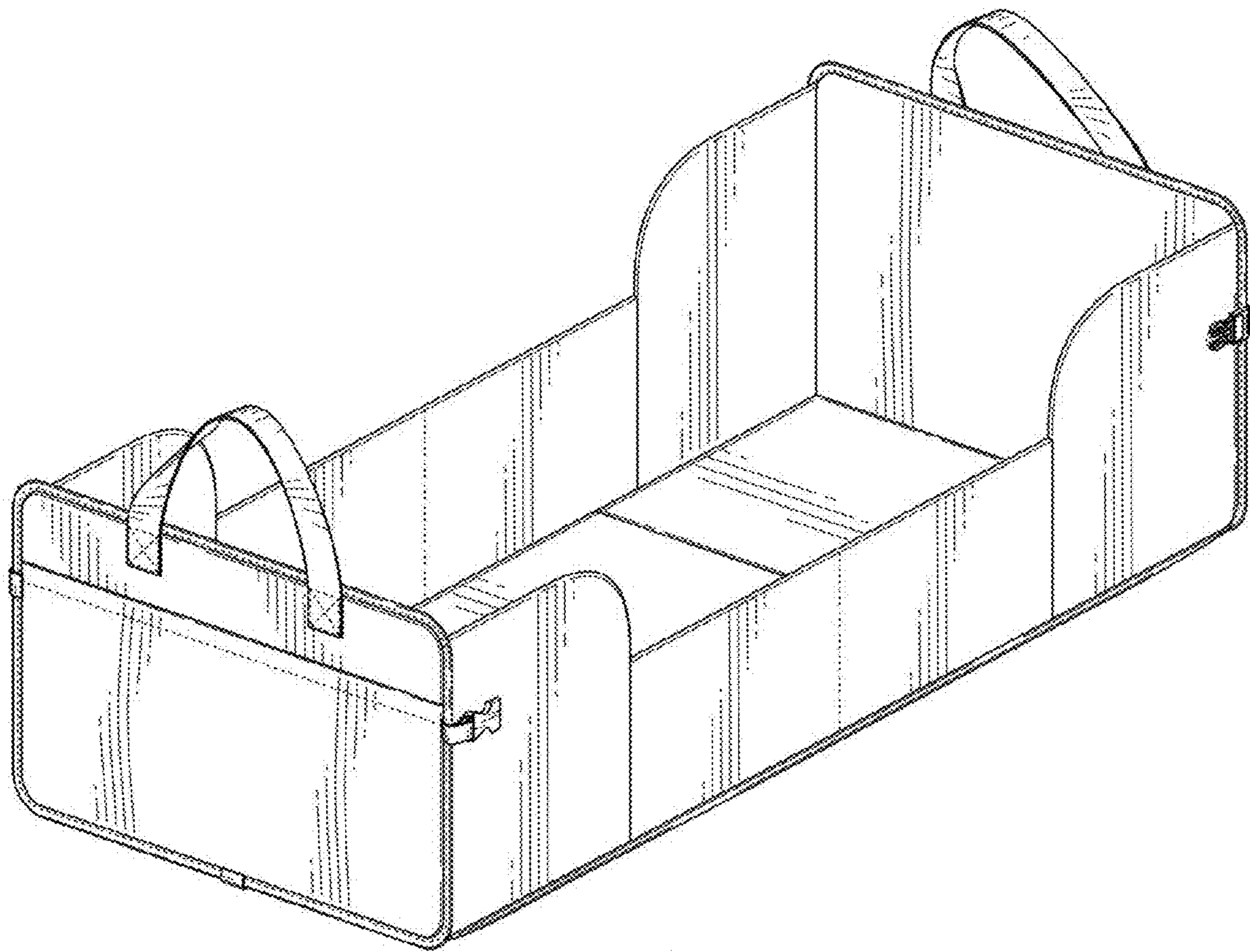

FIG. 1.13

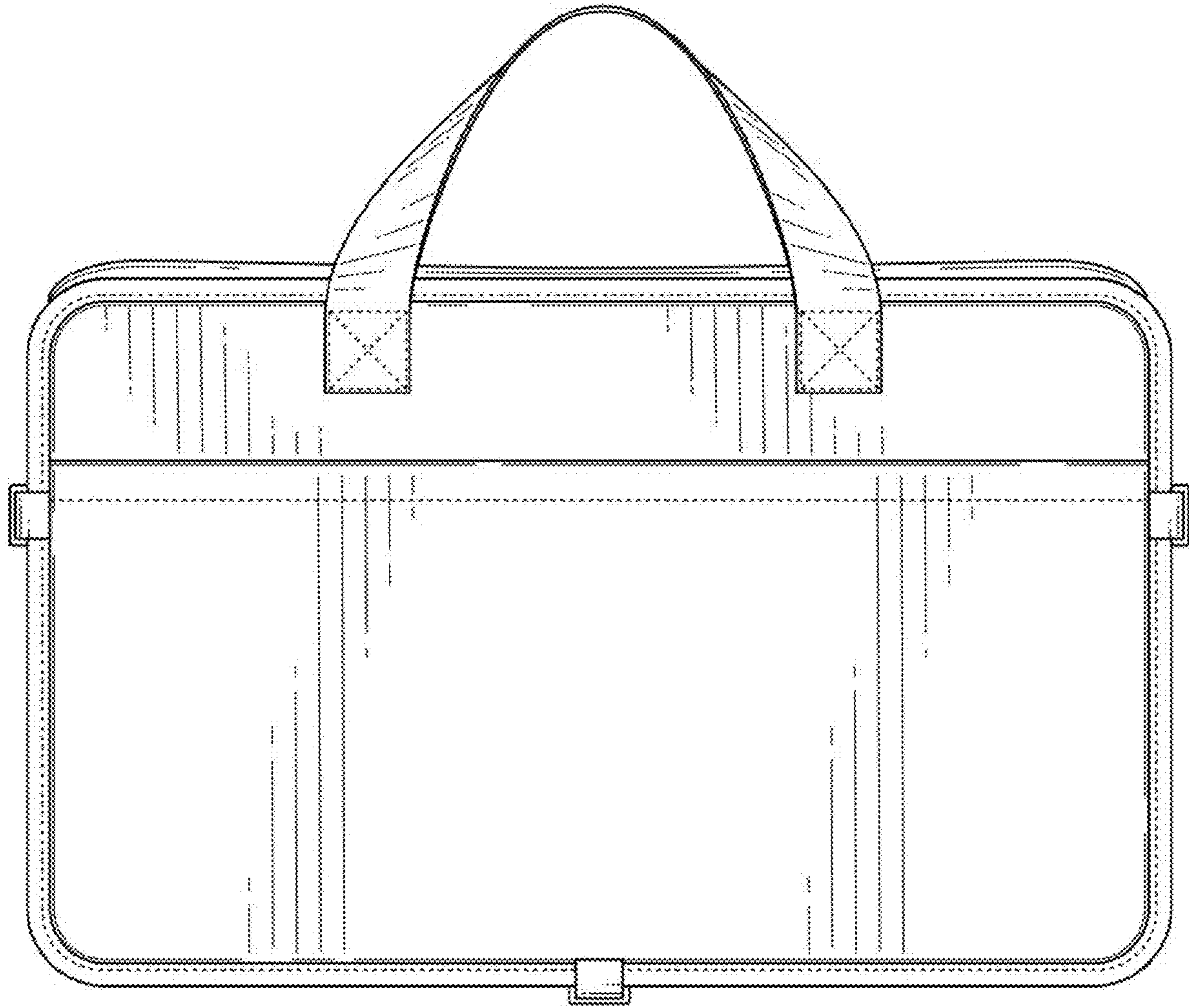

FIG. 1.14

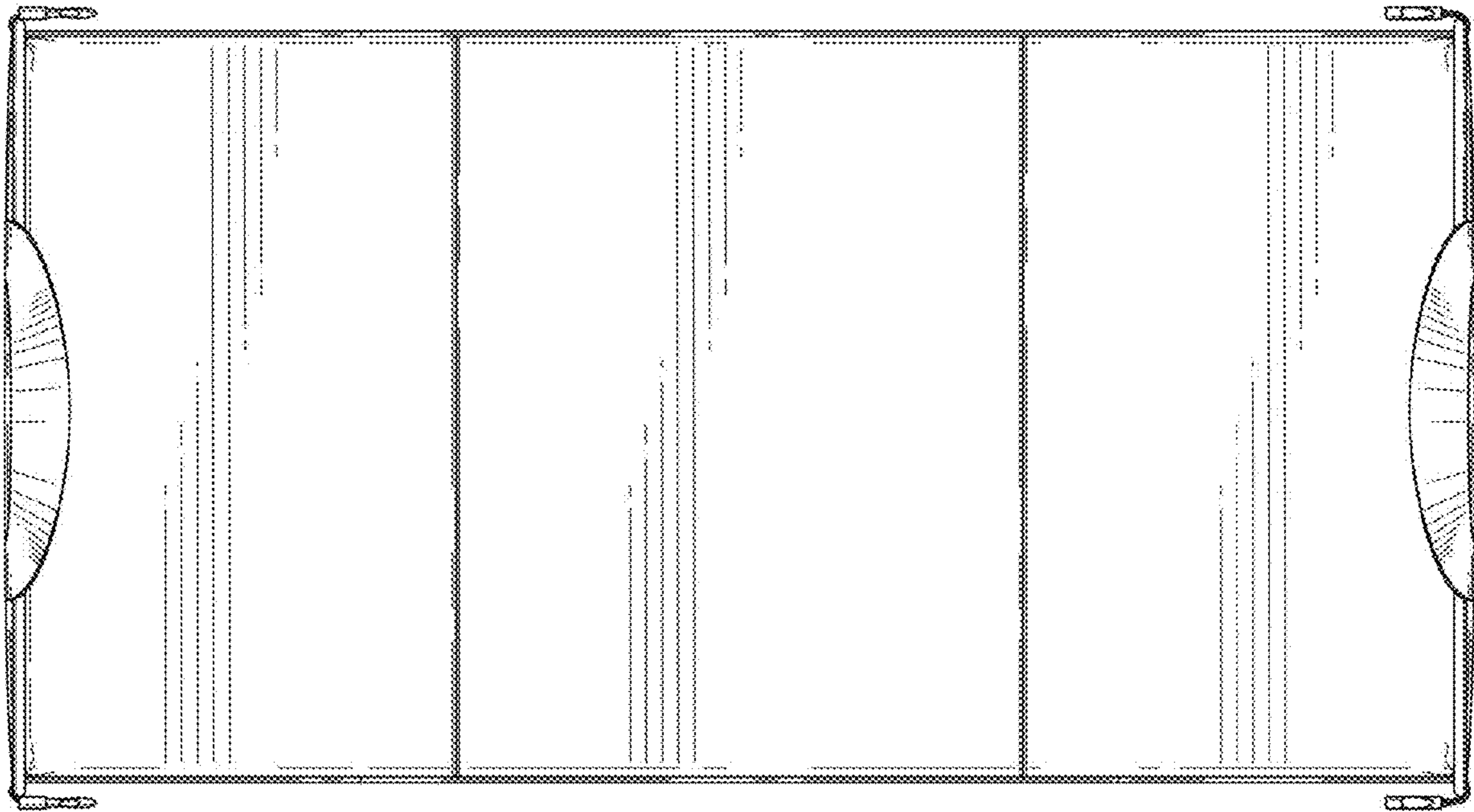

FIG. 1.15

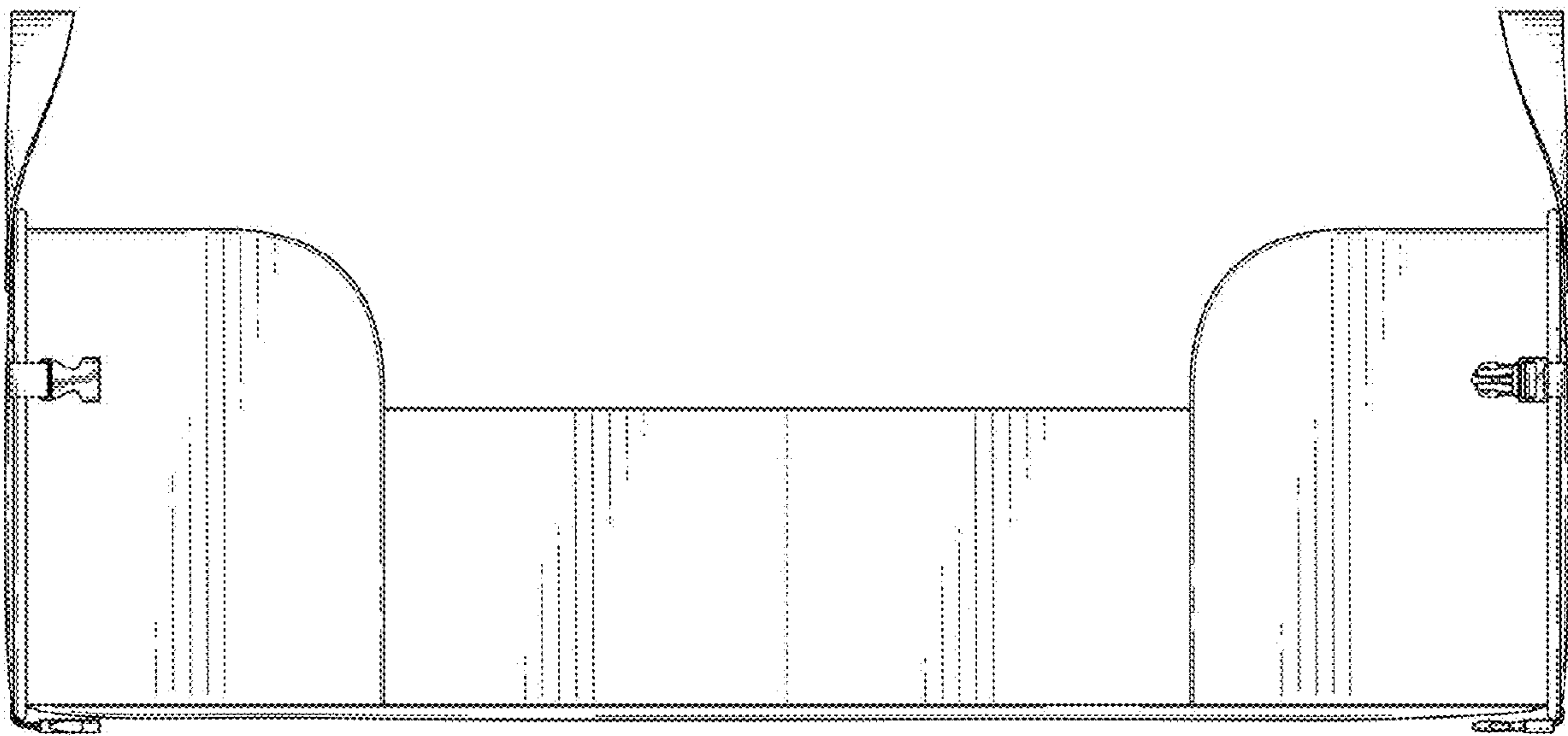

FIG. 1.16

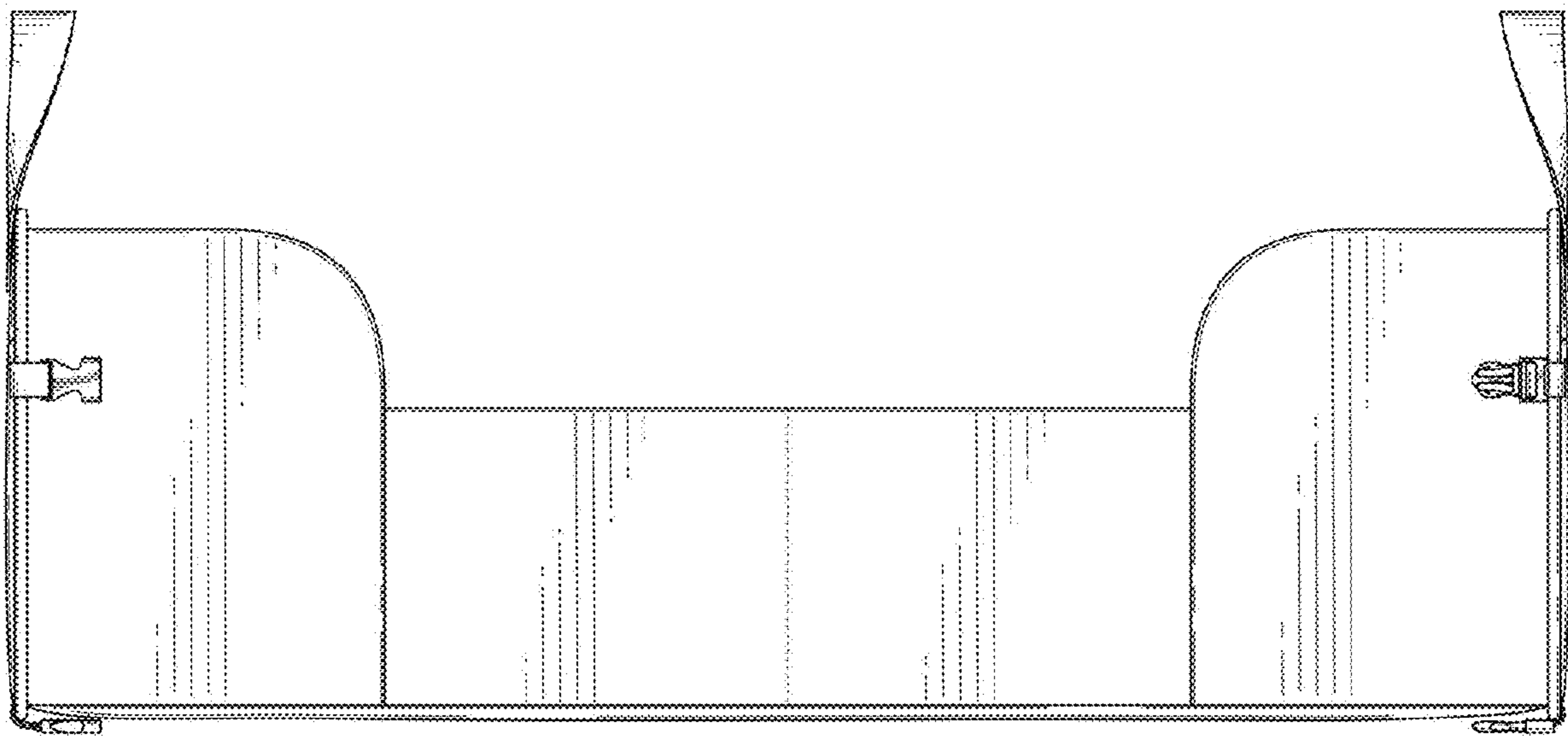

FIG. 1.17

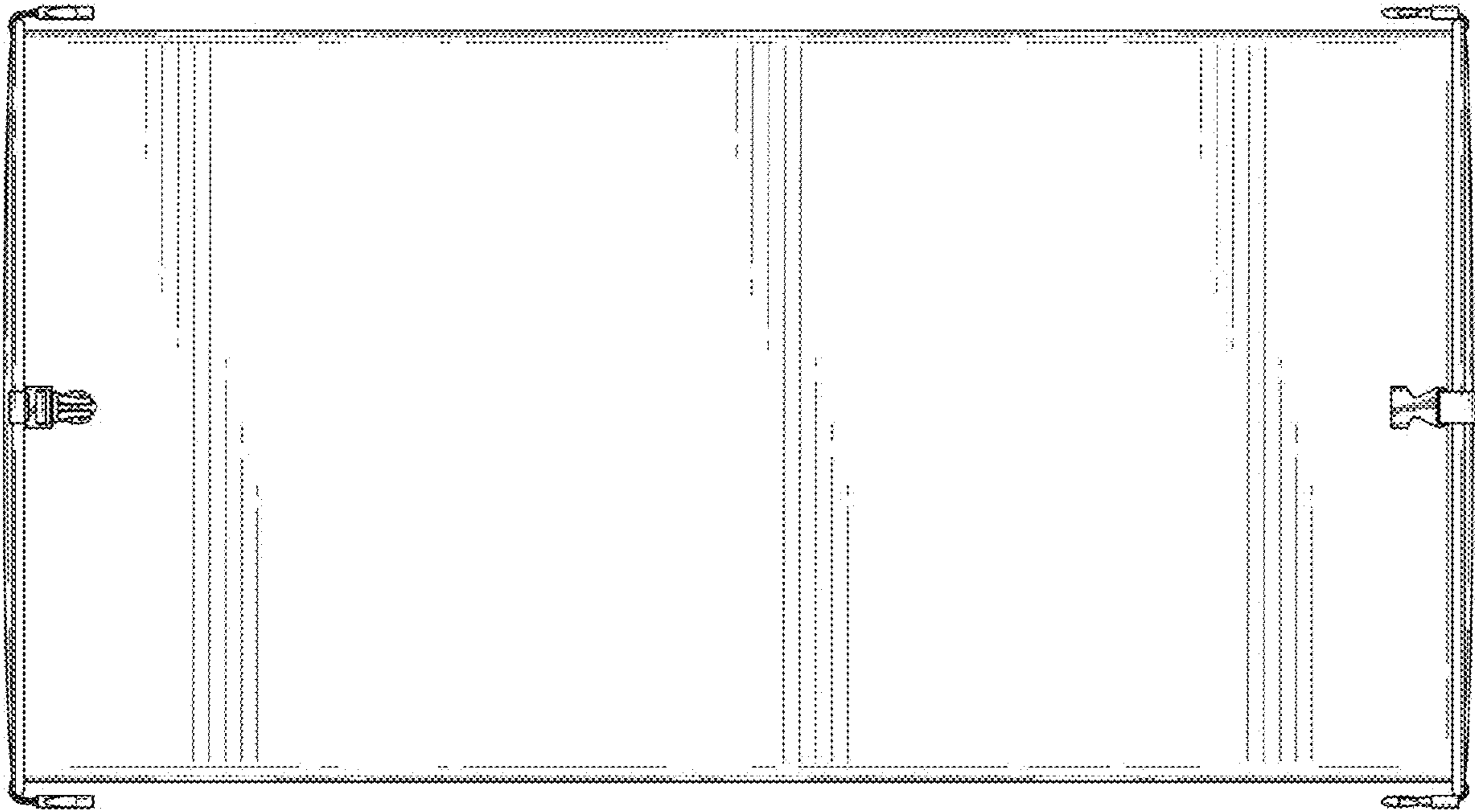

FIG. 1.18

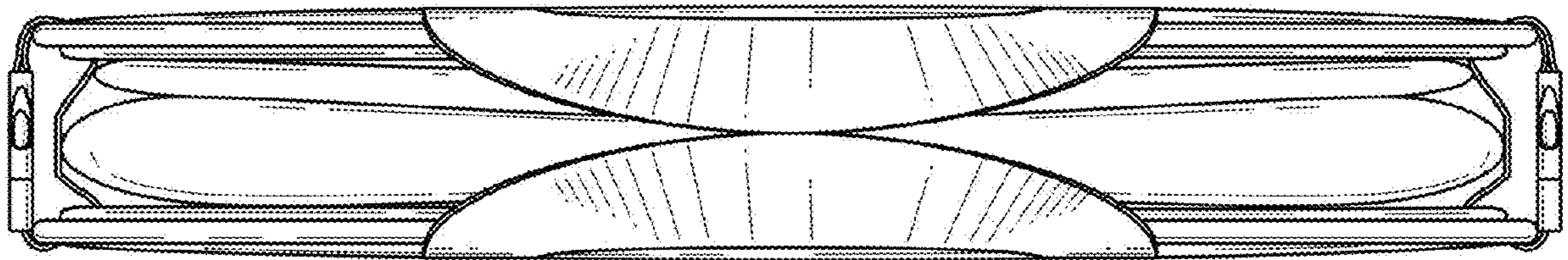

FIG. 1.19

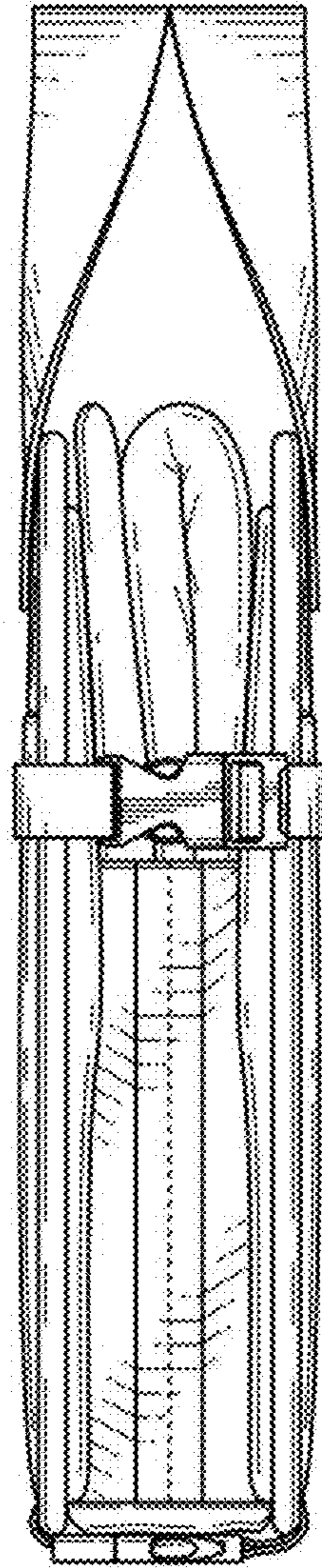

FIG. 1.20

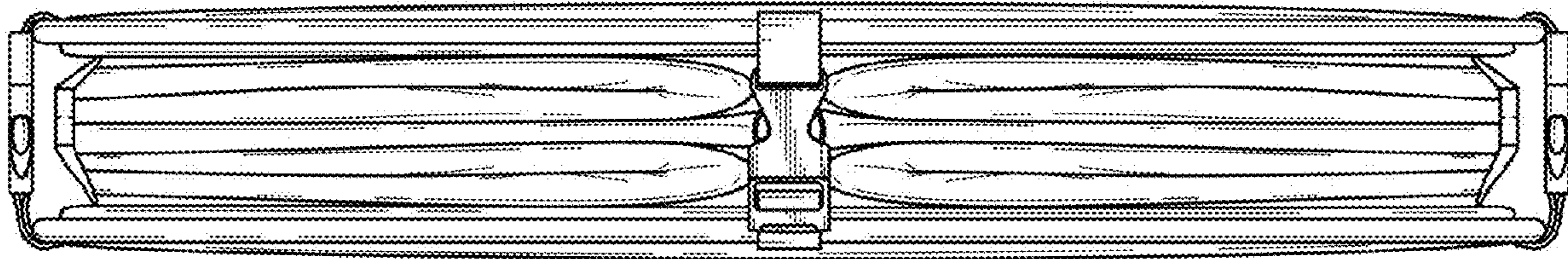

FIG. 1.21

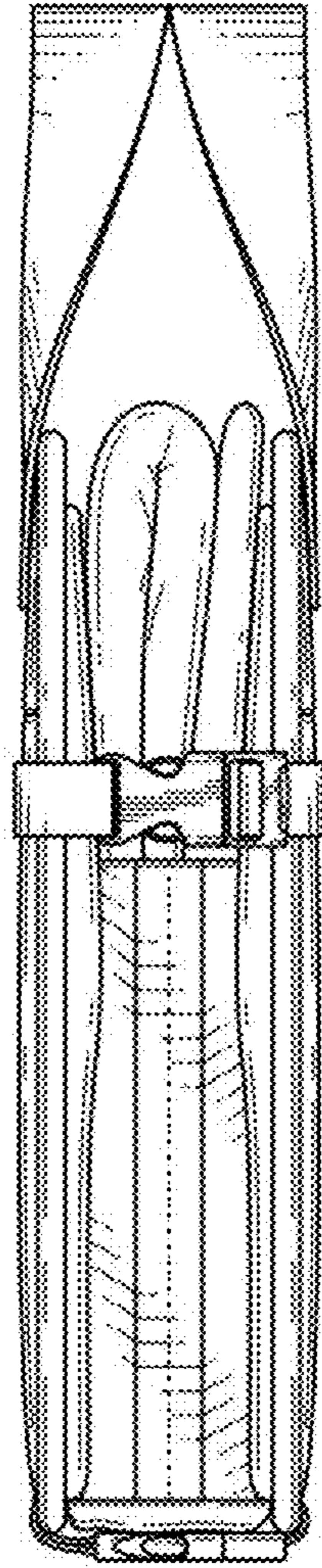

FIG. 1.22

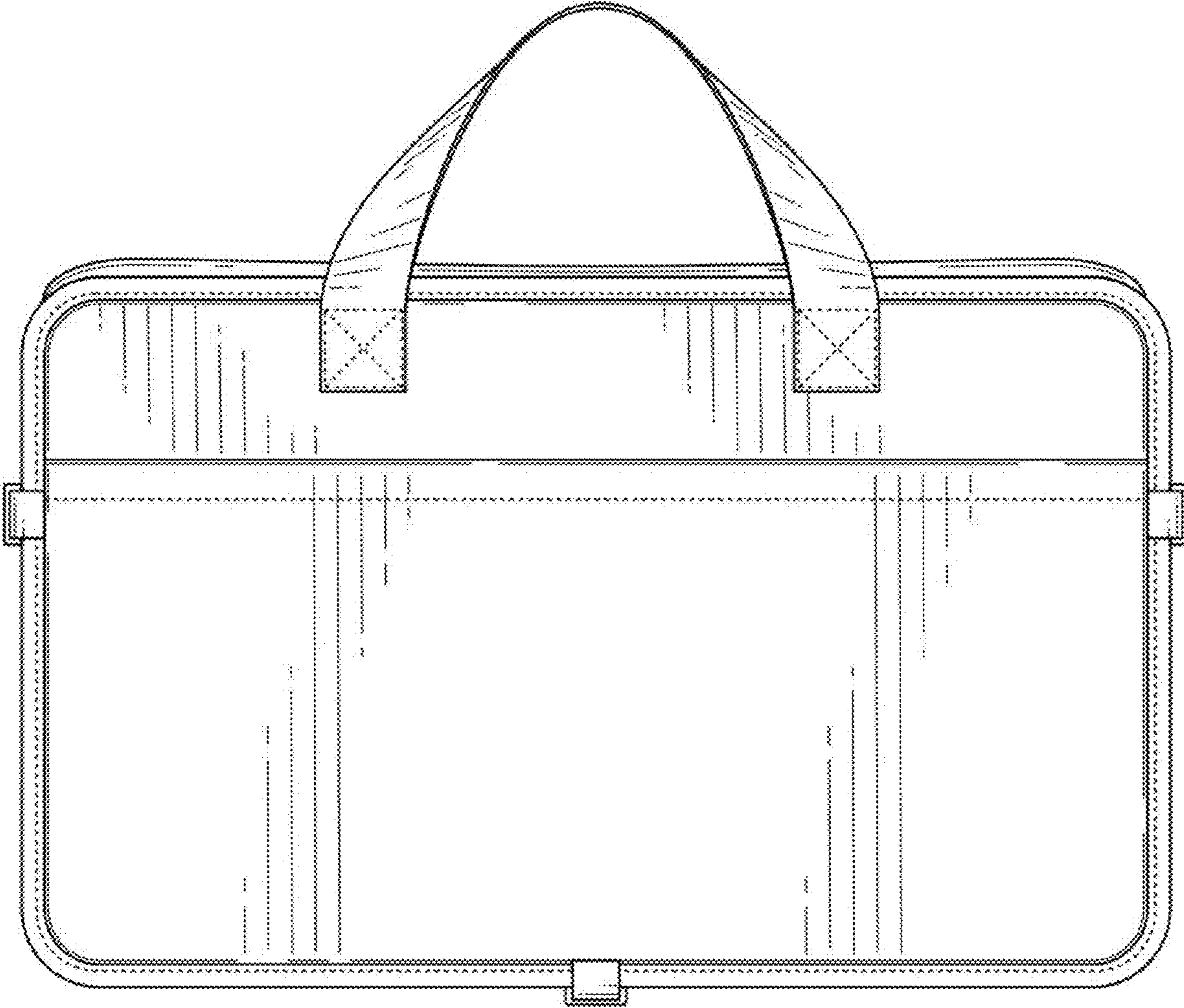

FIG. 1.23

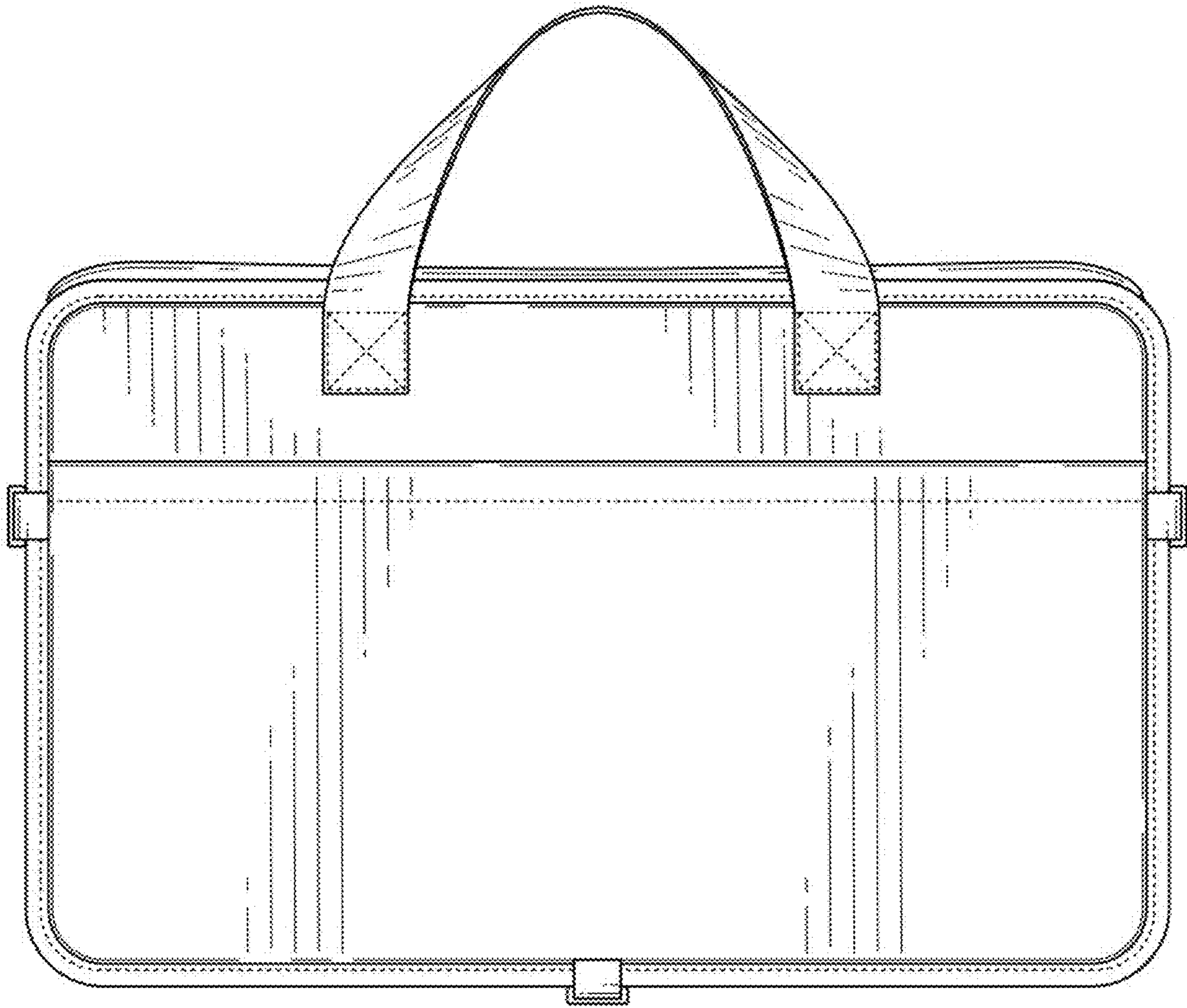

FIG. 1.24



FIG. 1.25