



US00D936851S

(12) **United States Design Patent** (10) **Patent No.:** **US D936,851 S**
Janicki et al. (45) **Date of Patent:** **** Nov. 23, 2021**

(54) **FLOAT POD**

(71) Applicant: **True Rest Franchising LLC**,
Coronado, CA (US)

(72) Inventors: **Nicholas Janicki**, Tempe, AZ (US);
Abraham Kezirian, Fresno, CA (US);
Mark Jackson, Fresno, CA (US);
Shaun Cuaron, Fresno, CA (US)

(73) Assignee: **True Rest Franchising, LLC**,
Coronado, CA (US)

(**) Term: **15 Years**

(21) Appl. No.: **29/725,748**

(22) Filed: **Feb. 26, 2020**

(51) **LOC (13) Cl.** **23-02**

(52) **U.S. Cl.**
USPC **D24/202**

(58) **Field of Classification Search**
USPC D24/201–205, 213; D23/276–278,
D23/280.1–280.3; D25/2
CPC A61H 33/6005; A61H 33/6021; A61H
33/6089; A61H 33/6094; A61H 2035/004;
A61H 35/006; A61H 33/06; A61H
33/066; A47K 3/022; A47K 3/062
See application file for complete search history.

(56) **References Cited**

U.S. PATENT DOCUMENTS

D275,605 S * 9/1984 Taylor D24/202
D314,429 S * 2/1991 Collier D24/202
D317,650 S * 6/1991 Soder D24/202

D360,469 S * 7/1995 Panelli D24/202
D367,709 S * 3/1996 Lawing D24/201
D442,695 S * 5/2001 Charlier D24/202
D541,423 S * 4/2007 Gay D24/202
D645,567 S * 9/2011 Walker D24/204
2018/0053508 A1* 2/2018 Agnew A61H 33/6005
2019/0015624 A1* 1/2019 Hill A61H 33/04

FOREIGN PATENT DOCUMENTS

CA 111001 * 10/2006

* cited by examiner

Primary Examiner — Anhdao Doan

(74) *Attorney, Agent, or Firm* — Symbus Law Group,
LLC; Clifford D. Hyra

(57) **CLAIM**

The ornamental design for a float pod, as shown and described.

DESCRIPTION

FIG. 1 is a front, top, left side perspective view of a float pod, showing the new design;
FIG. 2 is a front, top, left side perspective view thereof, in a position of use with the doors open;
FIG. 3 is a front view thereof;
FIG. 4 is a rear view thereof;
FIG. 5 is a right side view thereof;
FIG. 6 is a left side view thereof;
FIG. 7 is a top view thereof; and,
FIG. 8 is a bottom view thereof.

The broken lines depicting a human in FIG. 2 represent an environment and form no part of the claimed design; the remaining broken lines illustrate portions of the float pod that form no part of the claimed design.

1 Claim, 8 Drawing Sheets

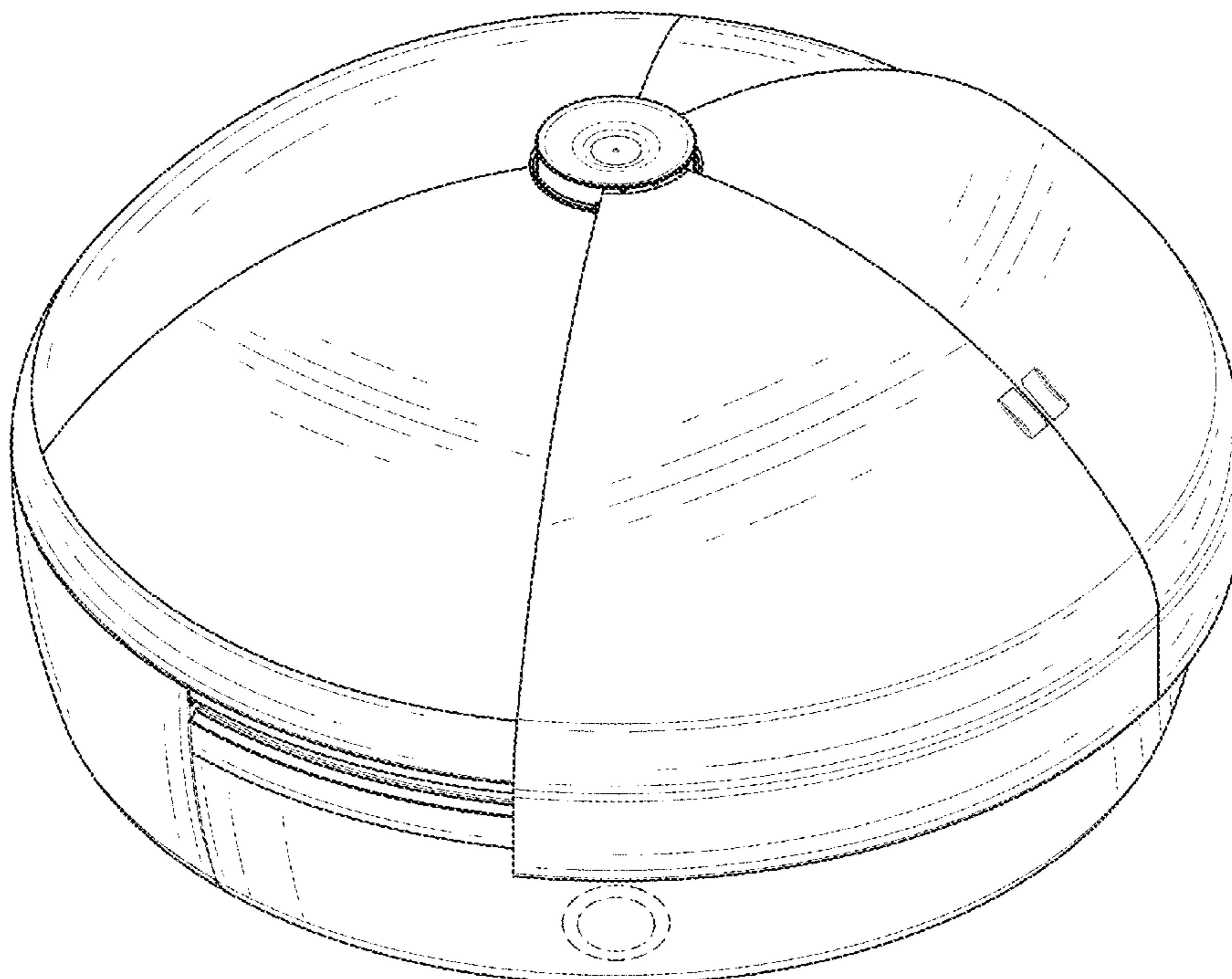

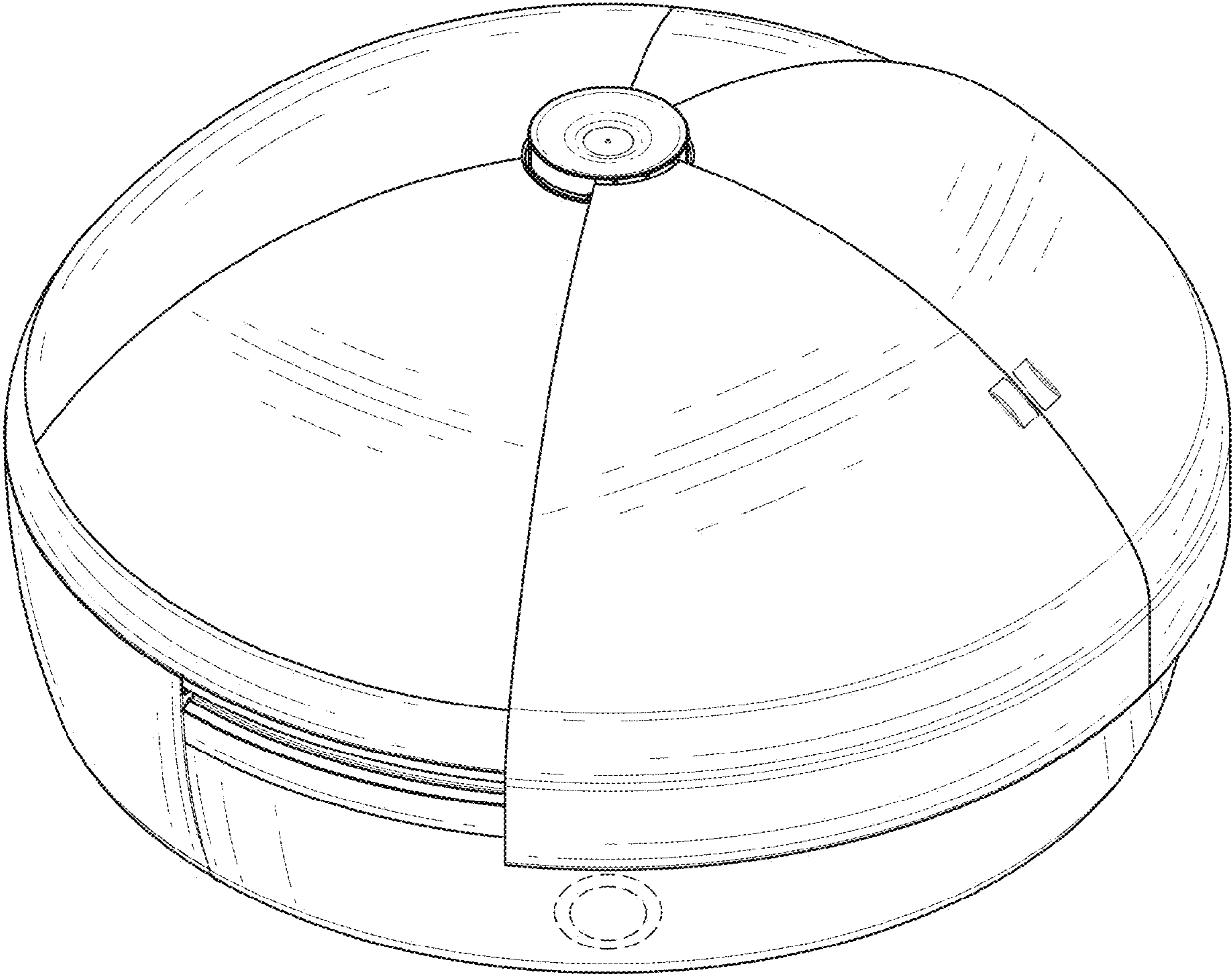

FIG. 1

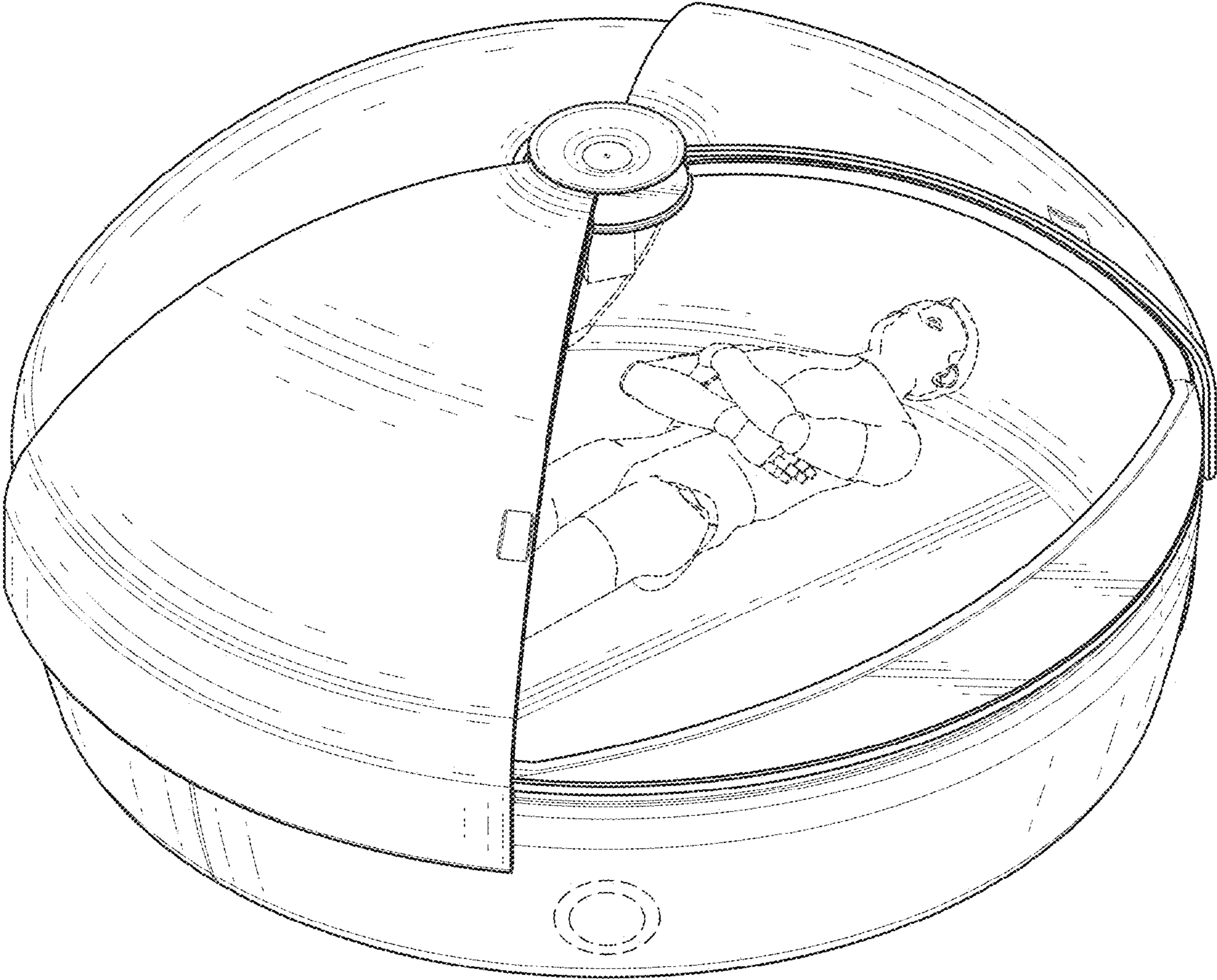

FIG. 2

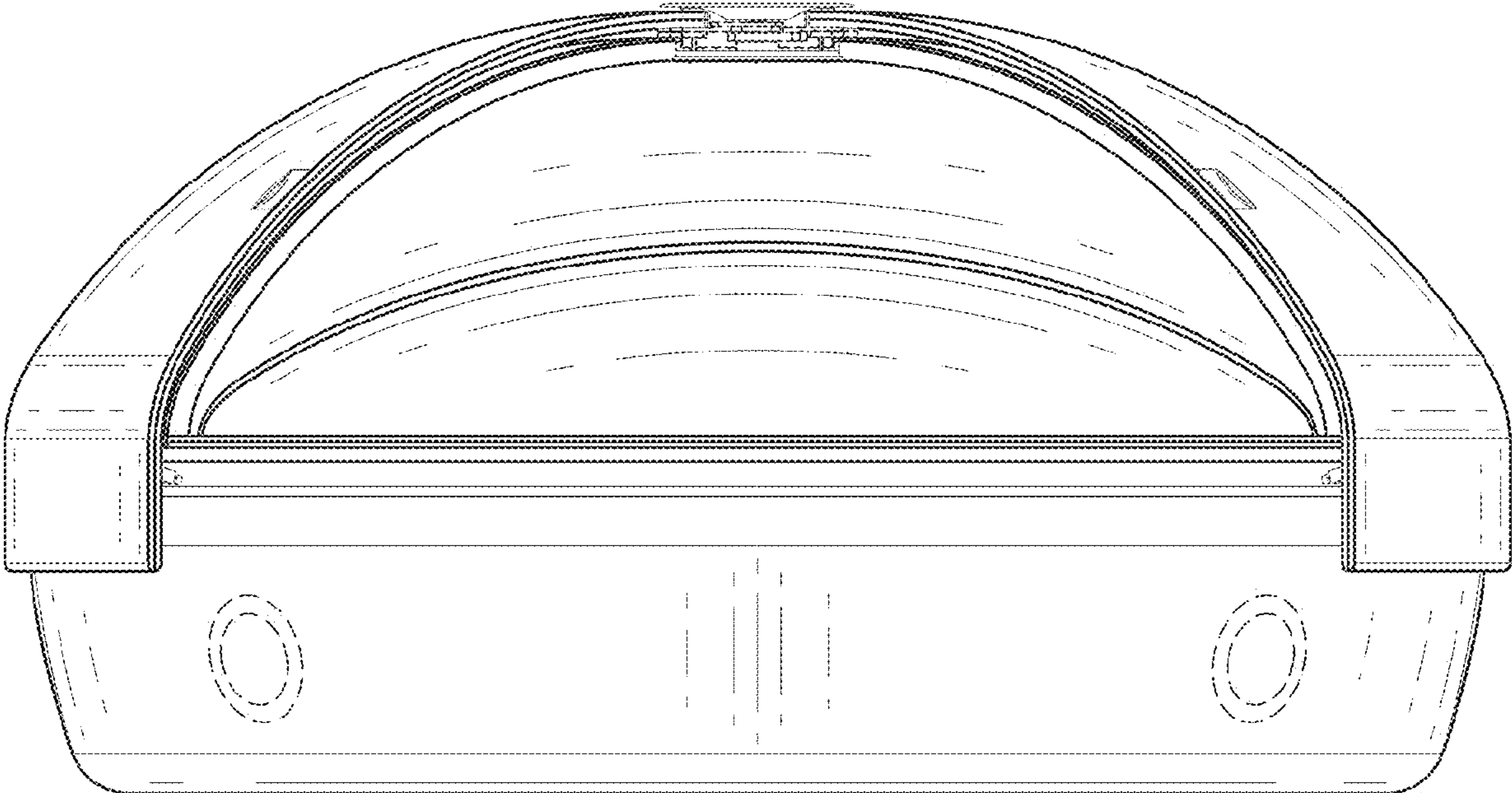

FIG. 3

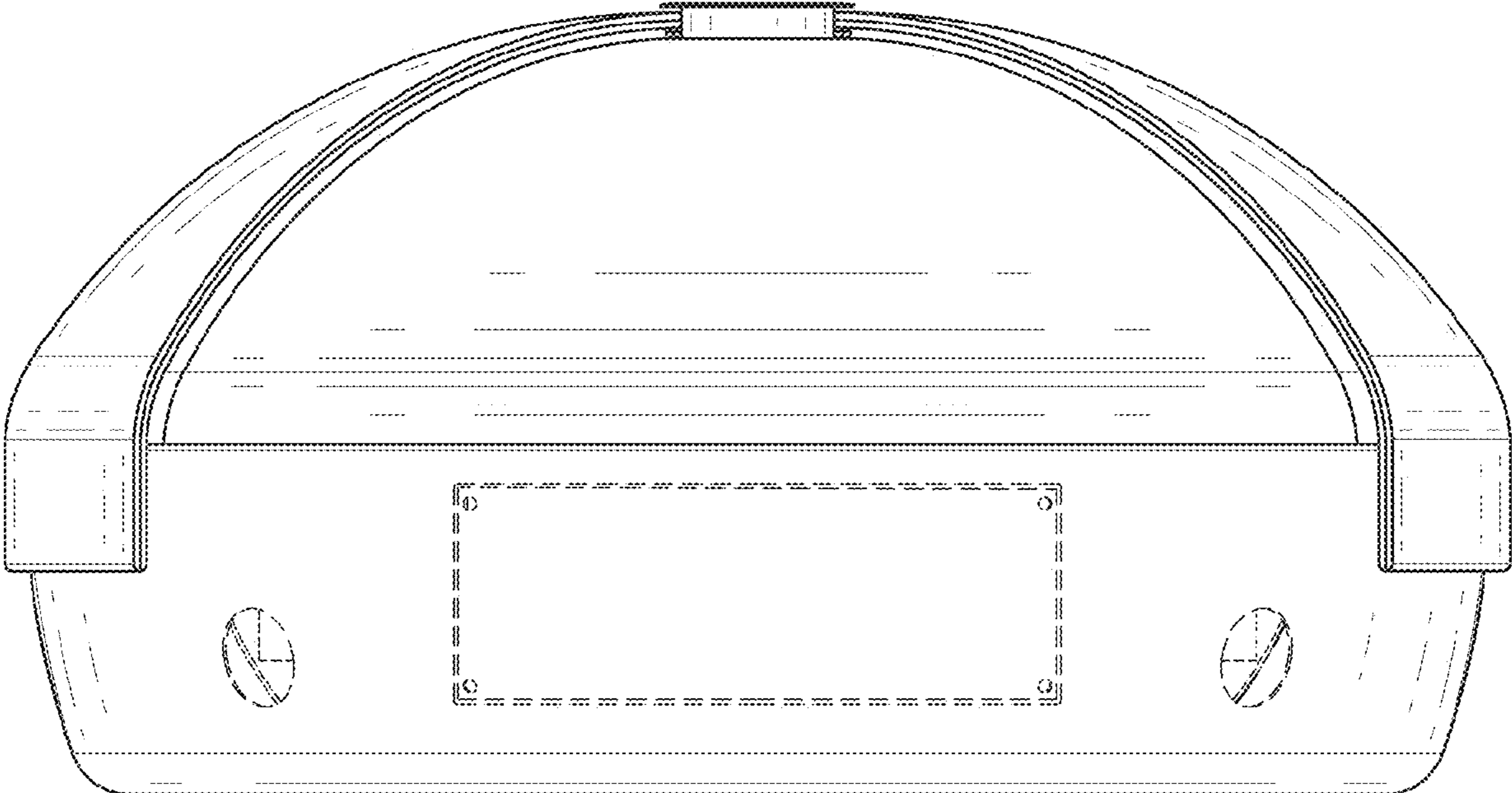

FIG. 4

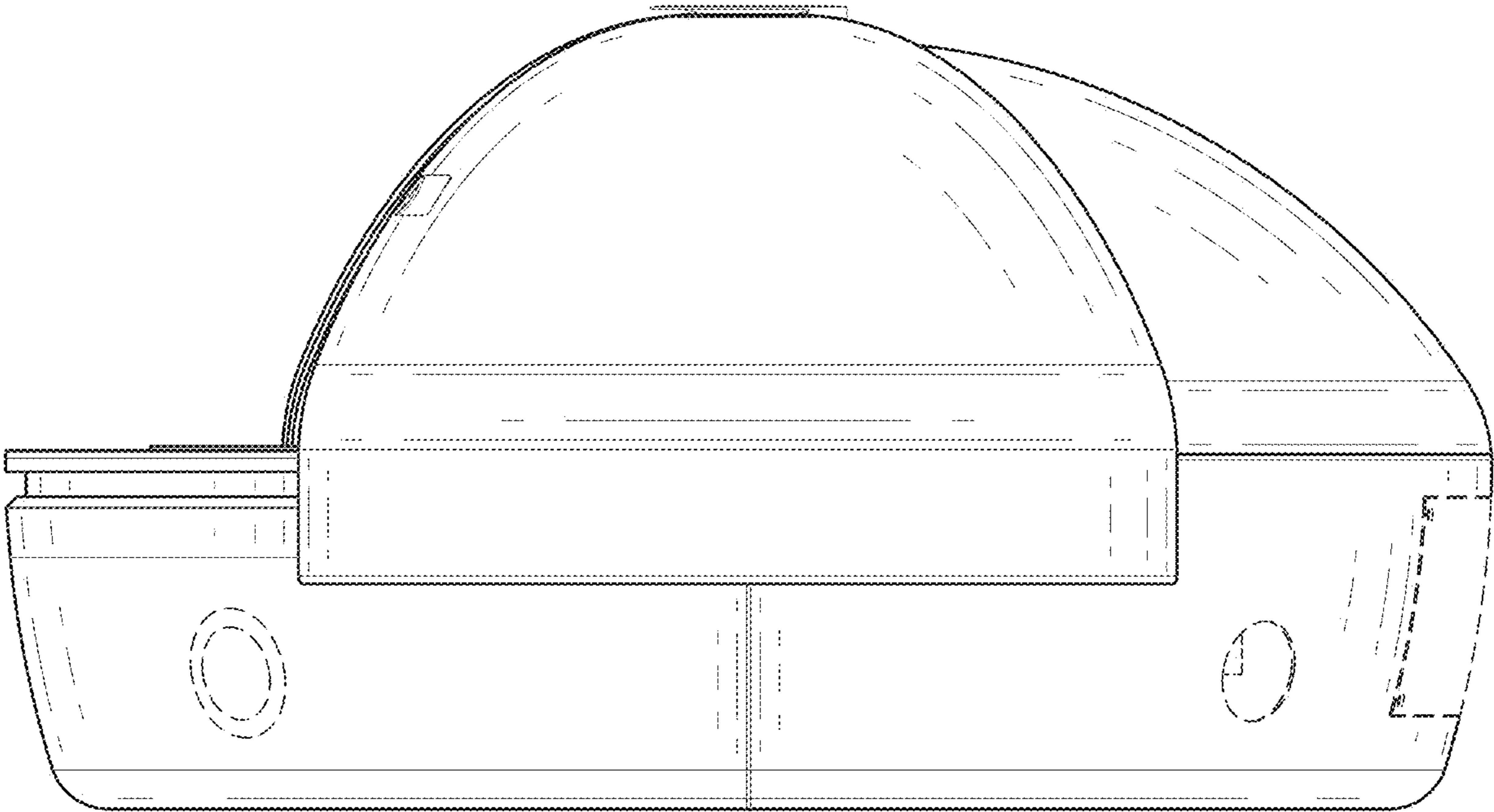

FIG. 5

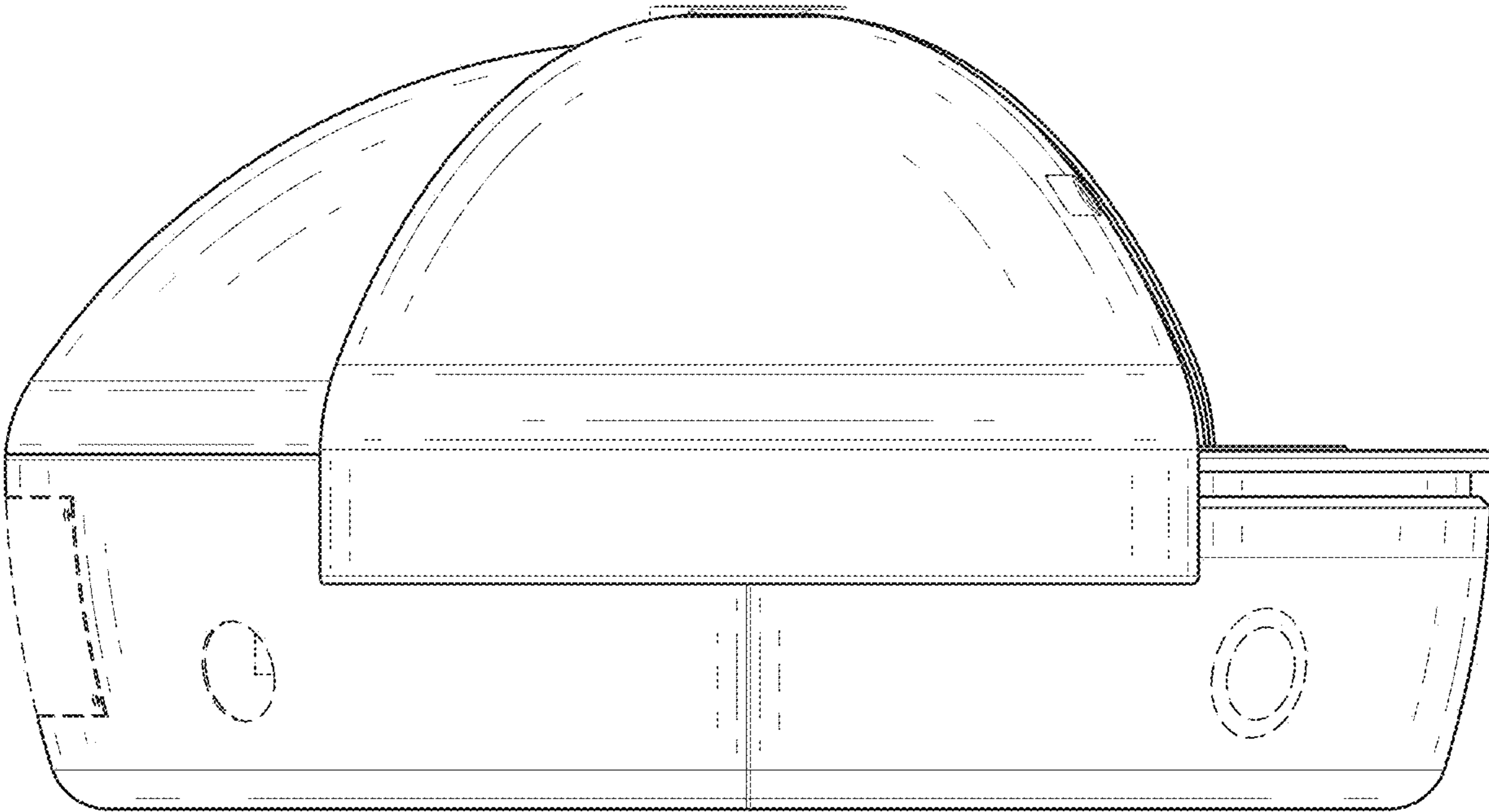

FIG. 6

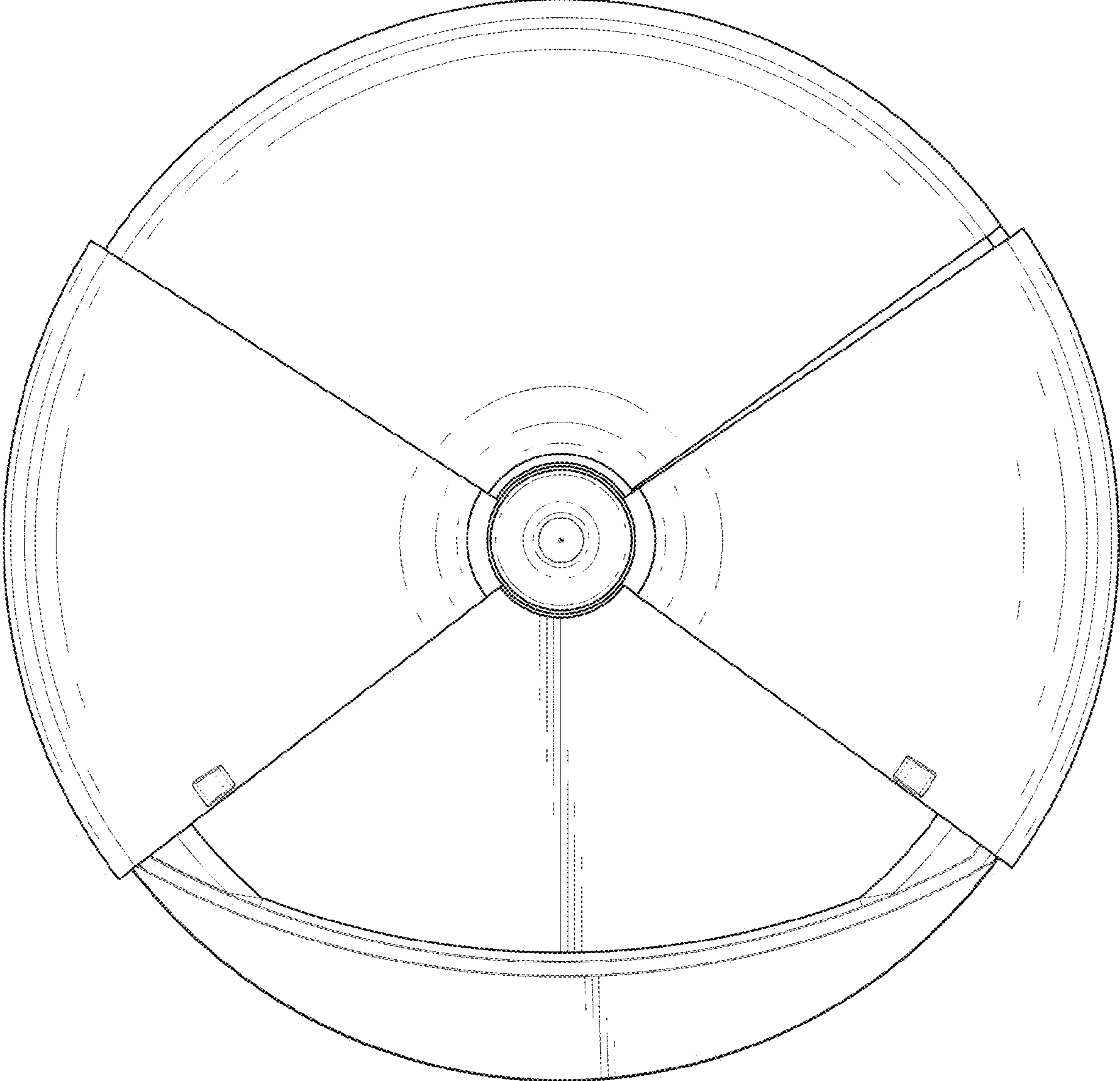

FIG. 7

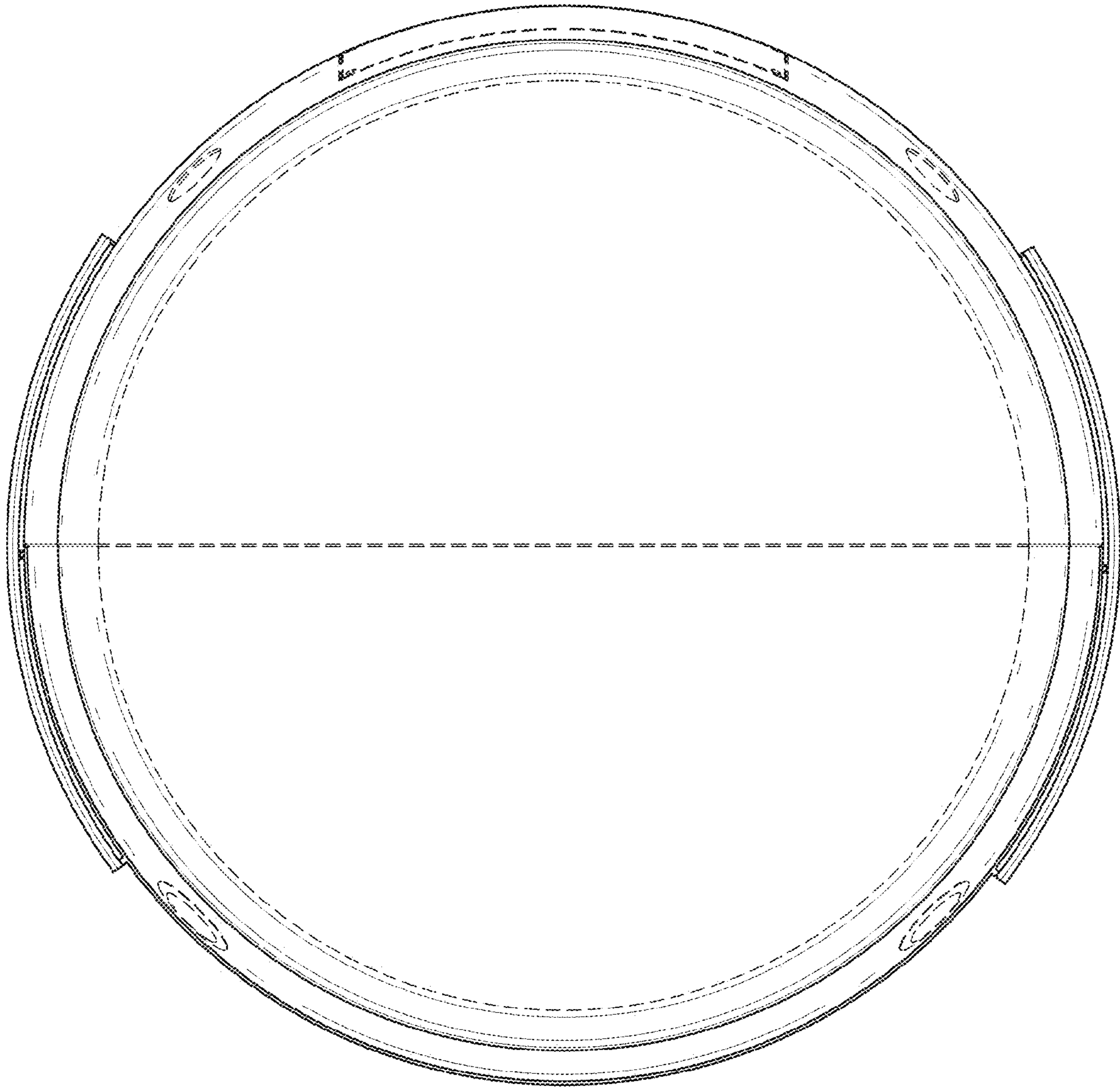

FIG. 8