



US00D936714S

(12) **United States Design Patent**  
**Nagtegaal**

(10) **Patent No.:** **US D936,714 S**

(45) **Date of Patent:** **\*\* Nov. 23, 2021**

(54) **DRILL BIT**

(71) Applicant: **Mirekaja A.G.**, Chur (CH)

(72) Inventor: **Willem R. Nagtegaal**, Chur (CH)

(73) Assignee: **MIREKAJA A.G.**, Chur (CH)

(\*\*) Term: **15 Years**

(21) Appl. No.: **29/715,353**

(22) Filed: **Dec. 2, 2019**

(30) **Foreign Application Priority Data**

Jun. 4, 2019 (EM) ..... 006564134

(51) **LOC (13) Cl.** ..... **15-09**

(52) **U.S. Cl.**  
USPC ..... **D15/139**

(58) **Field of Classification Search**  
USPC ..... D8/70; D15/21, 131, 139  
CPC ..... B27G 15/00; Y10T 408/902; Y10T  
408/9097; Y10T 408/90467  
See application file for complete search history.

(56) **References Cited**

**U.S. PATENT DOCUMENTS**

- D273,077 S \* 3/1984 Bell ..... D8/70
- D363,294 S \* 10/1995 Ellis ..... D15/139
- D416,267 S \* 11/1999 Reilly ..... D15/139
- D456,990 S \* 5/2002 Lusty ..... D3/228
- D531,650 S \* 11/2006 Switzer ..... D15/139
- D570,663 S \* 6/2008 Duggan ..... D8/70
- D626,575 S \* 11/2010 Washington, III ..... D15/139

- D627,807 S \* 11/2010 Tosti ..... D15/139
- D633,769 S \* 3/2011 Evatt ..... D8/70
- D656,611 S \* 3/2012 Garcia ..... D24/145
- D656,612 S \* 3/2012 Garcia ..... D24/145
- D705,282 S \* 5/2014 Jones, Jr. .... D15/139
- D779,732 S \* 2/2017 Nguyen ..... D28/59
- 10,562,109 B2 \* 2/2020 Hammond, Jr. .... B23B 51/06
- 10,605,007 B2 \* 3/2020 Kim ..... C22C 38/002
- 10,723,041 B2 \* 7/2020 Wang ..... B28D 1/146
- 10,731,420 B2 \* 8/2020 Dahlgren ..... E21B 10/08
- 10,821,522 B2 \* 11/2020 Giffin ..... B23B 31/1173
- D903,454 S \* 12/2020 Kuhns ..... D8/70
- 11,007,582 B2 \* 5/2021 Lee ..... B23B 49/005

\* cited by examiner

*Primary Examiner* — Patricia A Palasik

(74) *Attorney, Agent, or Firm* — Abelman, Frayne & Schwab

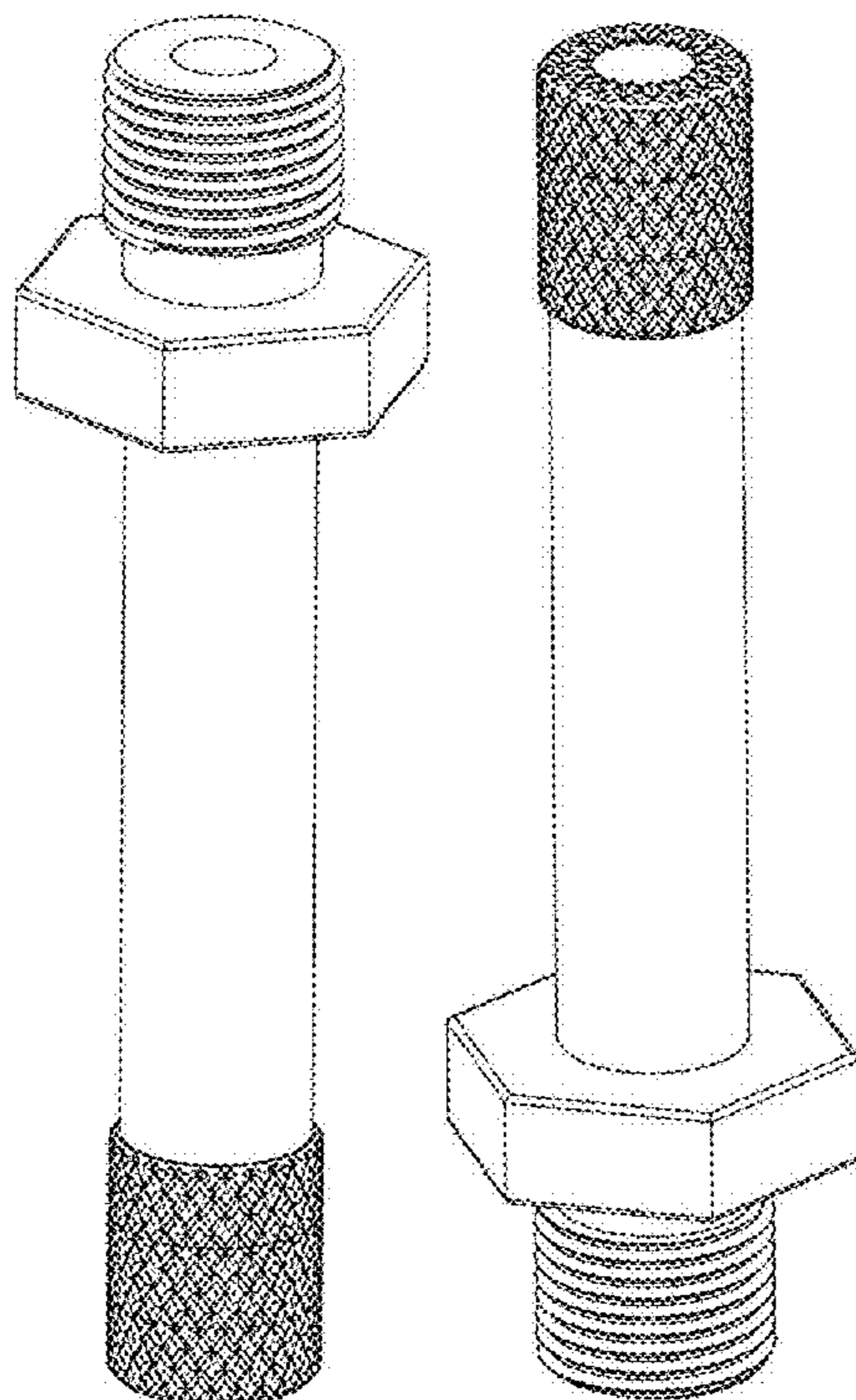
(57) **CLAIM**

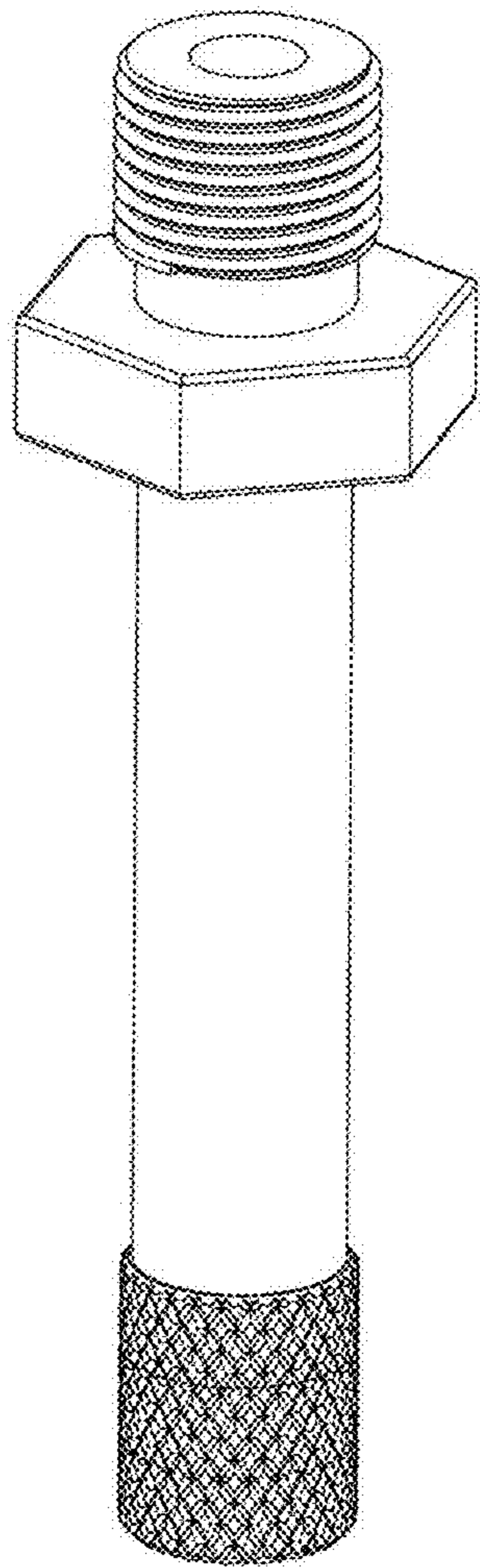
The ornamental design for a drill bit, as shown and described.

**DESCRIPTION**

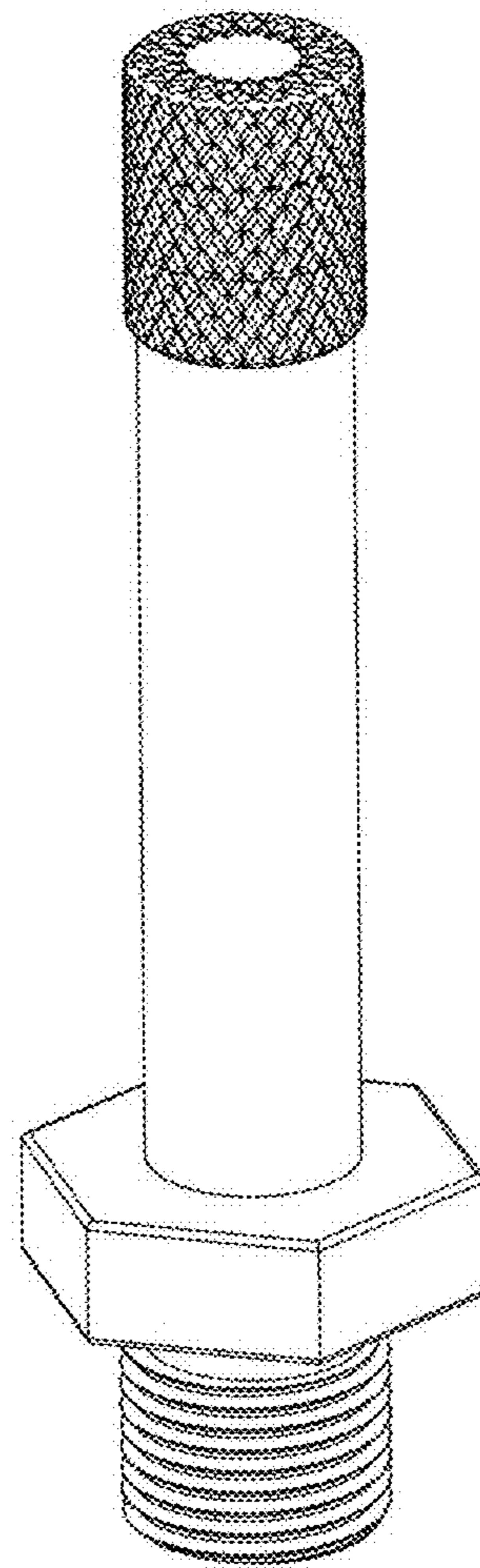
FIG. 1 is a front, left, and top perspective view of a first embodiment of a drill bit;  
 FIG. 2 is a front, right, and bottom perspective view thereof;  
 FIG. 3 is front view thereof;  
 FIG. 4 is a rear view thereof;  
 FIG. 5 is a left side elevational view thereof;  
 FIG. 6 is a right side elevational view thereof;  
 FIG. 7 is a top view thereof; and,  
 FIG. 8 is a bottom view thereof.

**1 Claim, 4 Drawing Sheets**

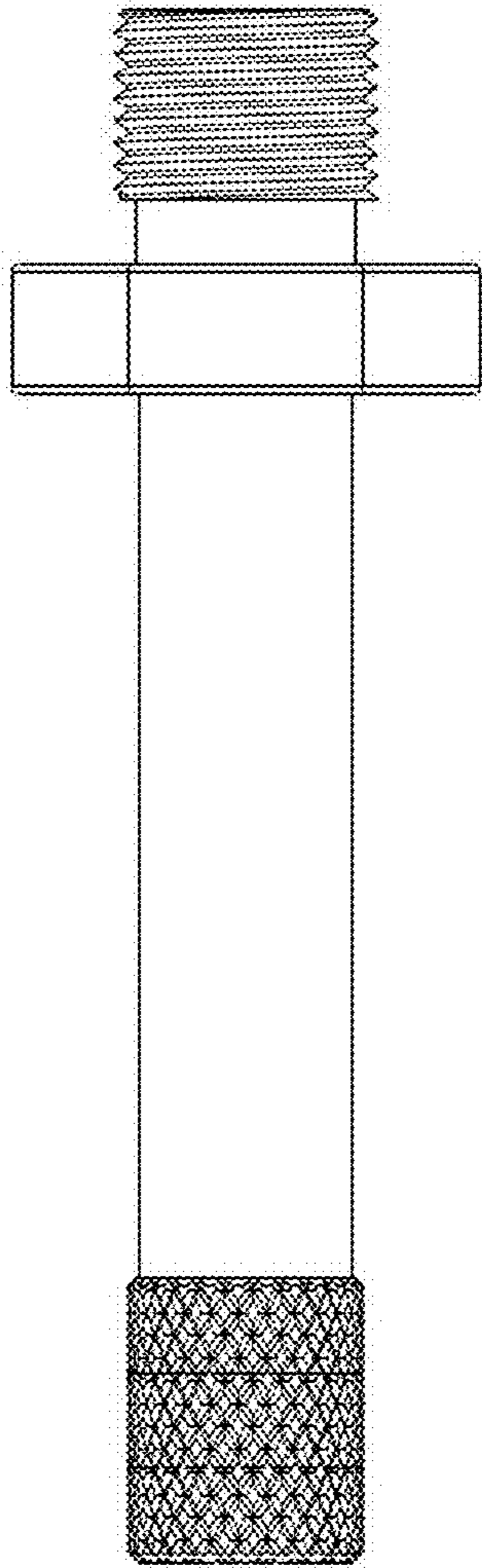




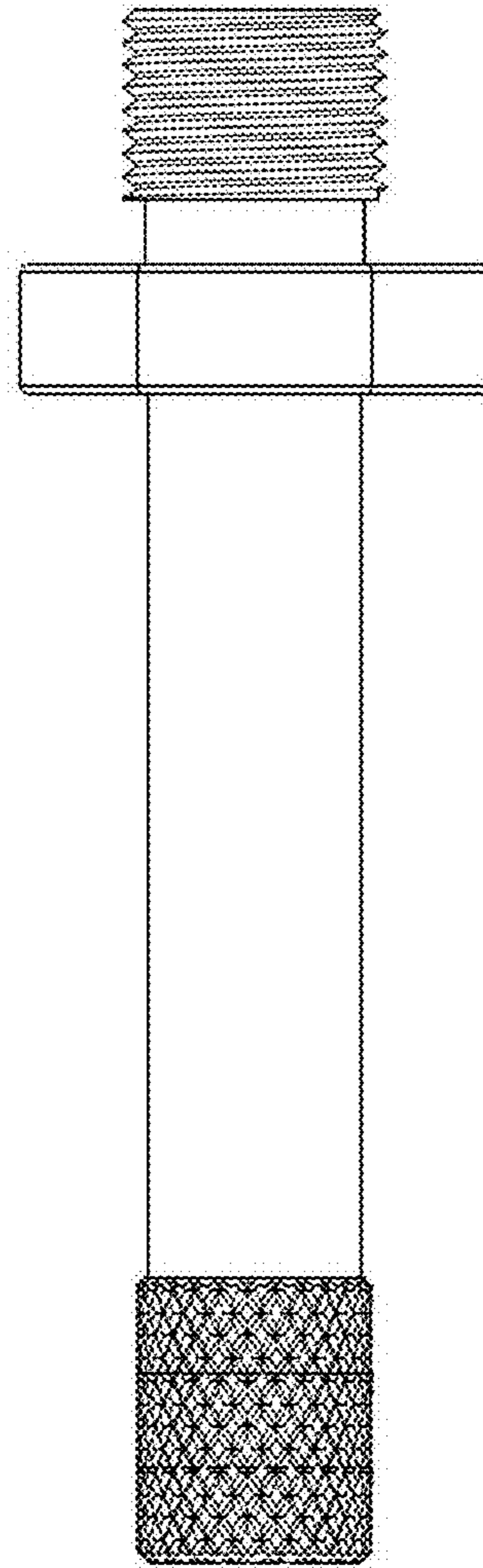
**FIG. 1**



**FIG. 2**



**FIG. 3**



**FIG. 4**



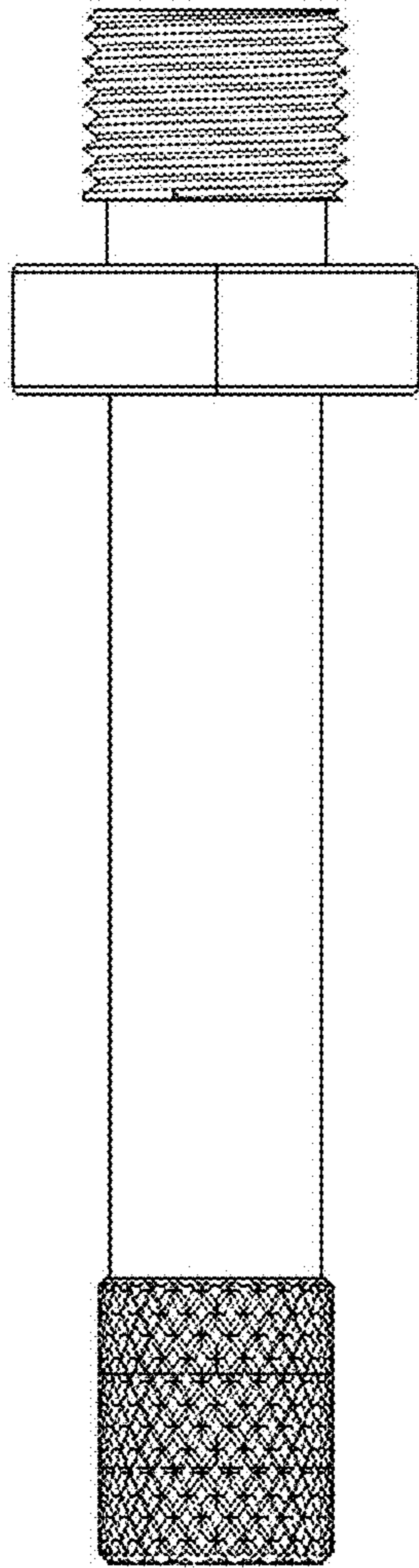


FIG. 5

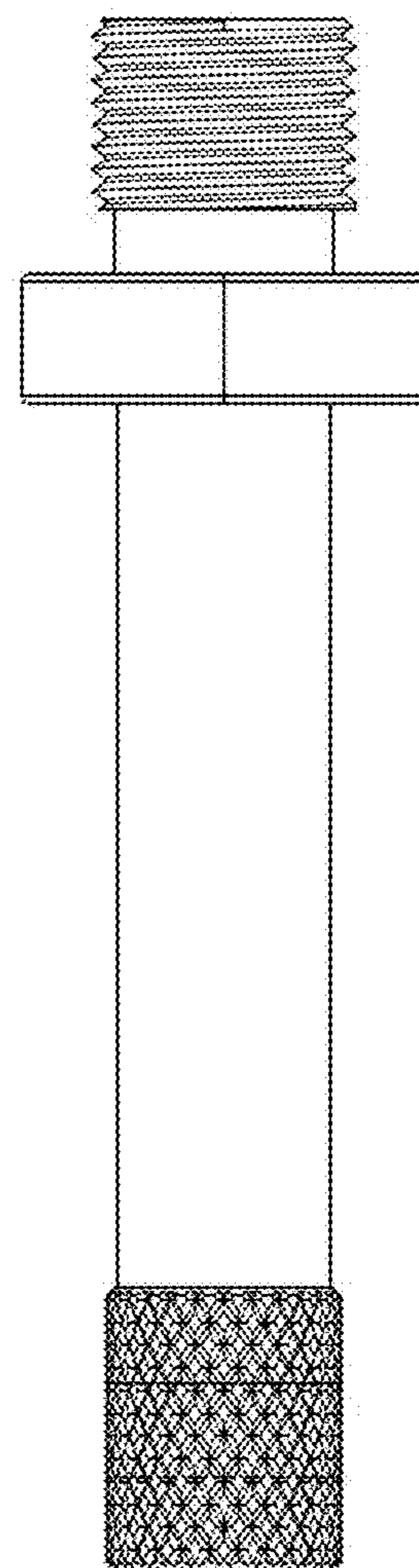
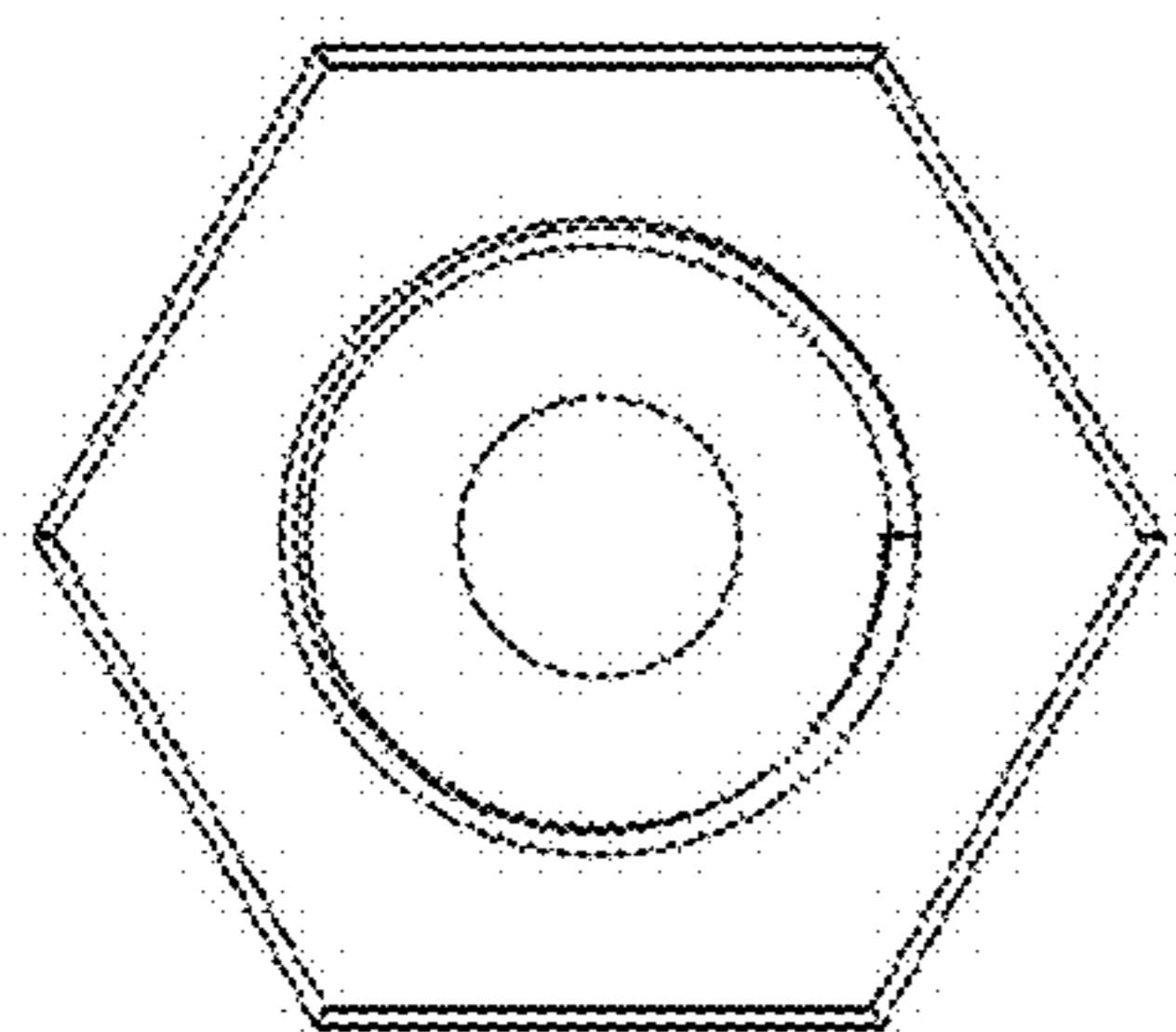
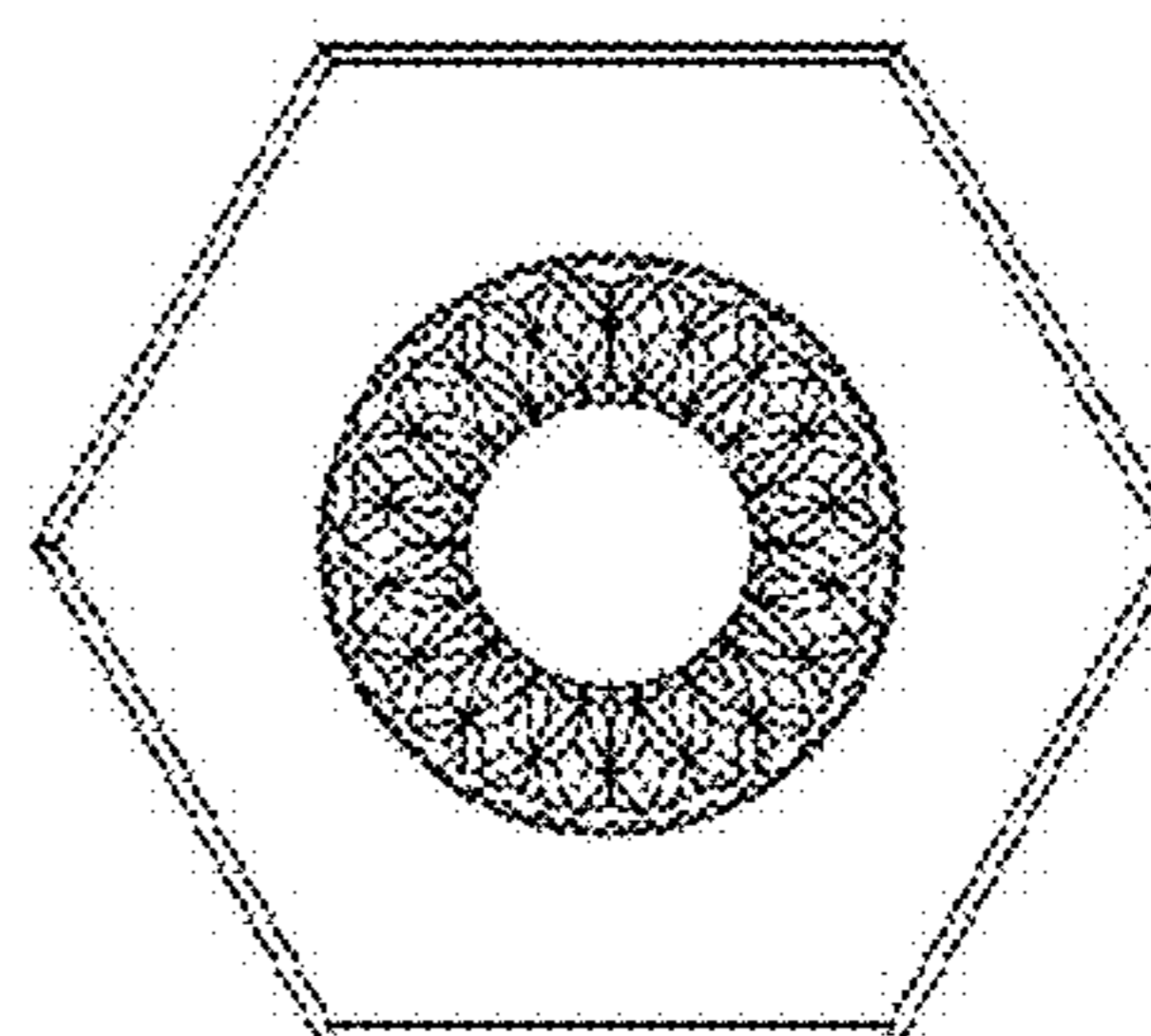


FIG. 6



**FIG. 7**



**FIG. 8**