



US00D936653S

(12) **United States Design Patent**  
**Huang**

(10) **Patent No.:** **US D936,653 S**

(45) **Date of Patent:** **\*\* Nov. 23, 2021**

(54) **STYLUS**

(71) Applicant: **Ling Huang**, Luoding (CN)

(72) Inventor: **Ling Huang**, Luoding (CN)

(\*\*) Term: **15 Years**

(21) Appl. No.: **29/758,859**

(22) Filed: **Nov. 19, 2020**

(51) **LOC (13) Cl.** ..... **14-02**

(52) **U.S. Cl.**  
USPC ..... **D14/411**

(58) **Field of Classification Search**  
USPC ..... D14/372, 496, 432, 371, 125, 126, 129,  
D14/299, 411; D16/300-342; 351/158,  
351/153, 144; 345/7-9, 905; 455/344;  
348/115, 53, 121, 739  
CPC ..... G02B 27/017; G06F 3/016; G06F 3/033;  
G06F 3/0317; G06F 3/03545; G06F  
3/041; G06K 9/222  
See application file for complete search history.

(56) **References Cited**

**U.S. PATENT DOCUMENTS**

D446,214 S 8/2001 Khovaylo et al.  
D681,113 S \* 4/2013 Huang ..... D19/185  
D685,430 S \* 7/2013 Zhang ..... D19/186

D772,875 S 11/2016 Kim et al.  
D825,566 S \* 8/2018 Peterson ..... D14/411  
D826,230 S \* 8/2018 Peterson ..... D14/411  
D863,436 S \* 10/2019 Thies ..... D19/186  
D896,810 S \* 9/2020 Akana ..... D14/411  
D901,585 S \* 11/2020 Vadenne ..... D19/186  
D908,703 S \* 1/2021 Huang ..... D14/411  
D909,379 S \* 2/2021 Liu ..... D14/411  
D909,380 S \* 2/2021 Liu ..... D14/411  
D921,628 S \* 6/2021 Huang ..... D14/411  
D921,632 S \* 6/2021 Huang ..... D14/411

\* cited by examiner

*Primary Examiner* — Austin Murphy  
(74) *Attorney, Agent, or Firm* — W&KIP

(57) **CLAIM**

The ornamental design for a stylus, as shown and described.

**DESCRIPTION**

FIG. 1 is a perspective view of a stylus showing my new design;  
FIG. 2 is another perspective view thereof;  
FIG. 3 is a front view thereof;  
FIG. 4 is a rear view thereof;  
FIG. 5 is a left side view thereof;  
FIG. 6 is a right side view thereof;  
FIG. 7 is an enlarged top plan view thereof; and,  
FIG. 8 is an enlarged bottom plan view thereof.

**1 Claim, 8 Drawing Sheets**

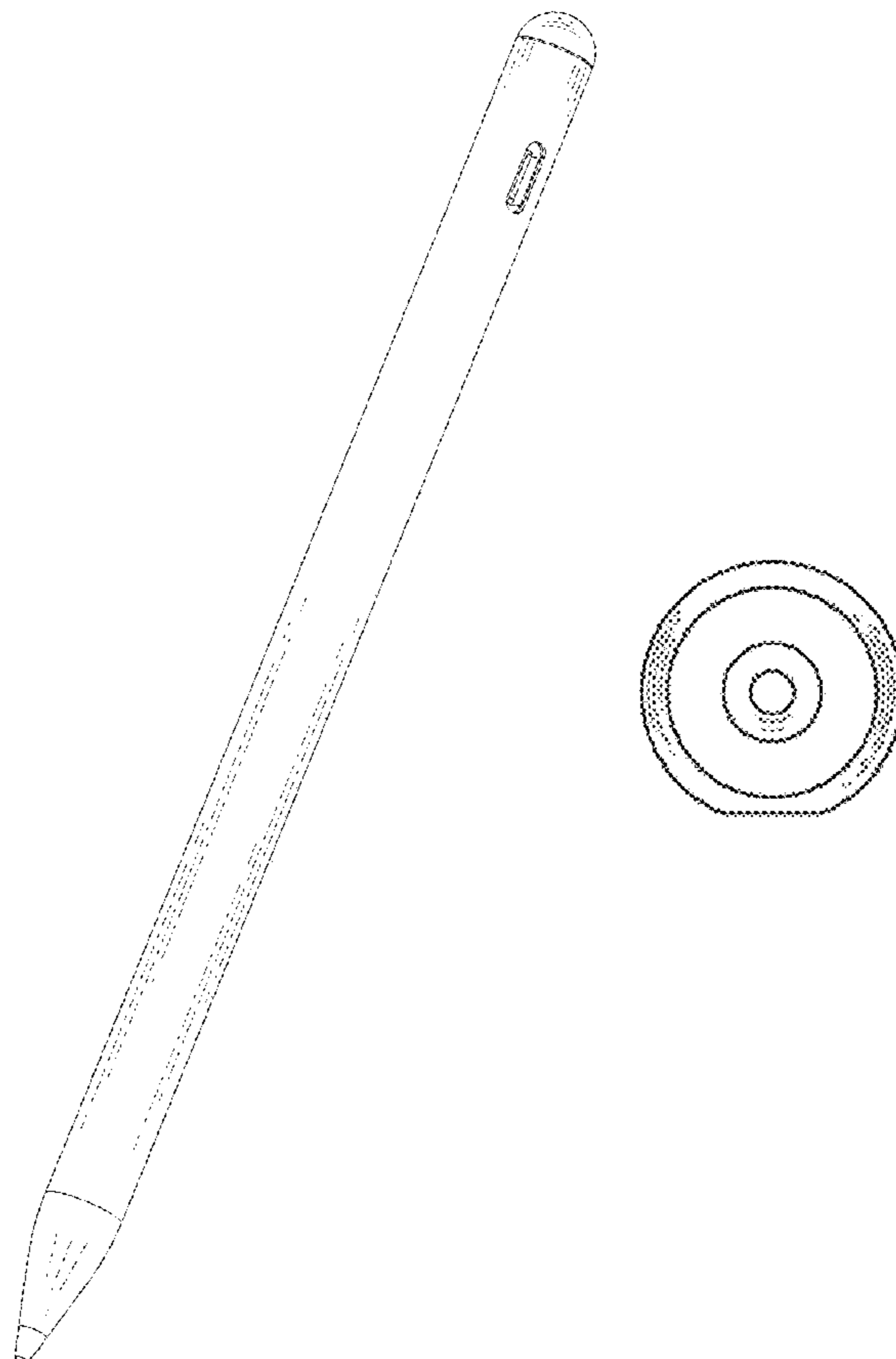

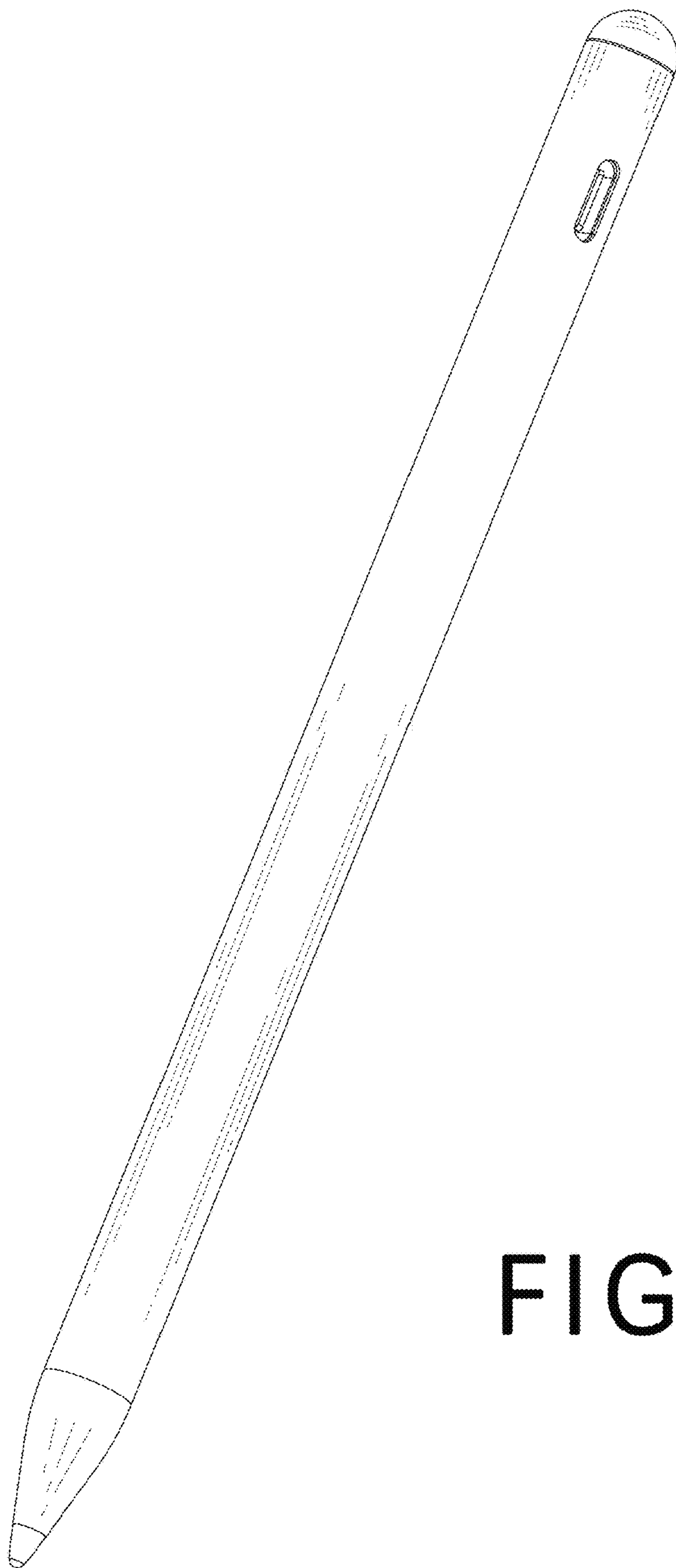

FIG. 1

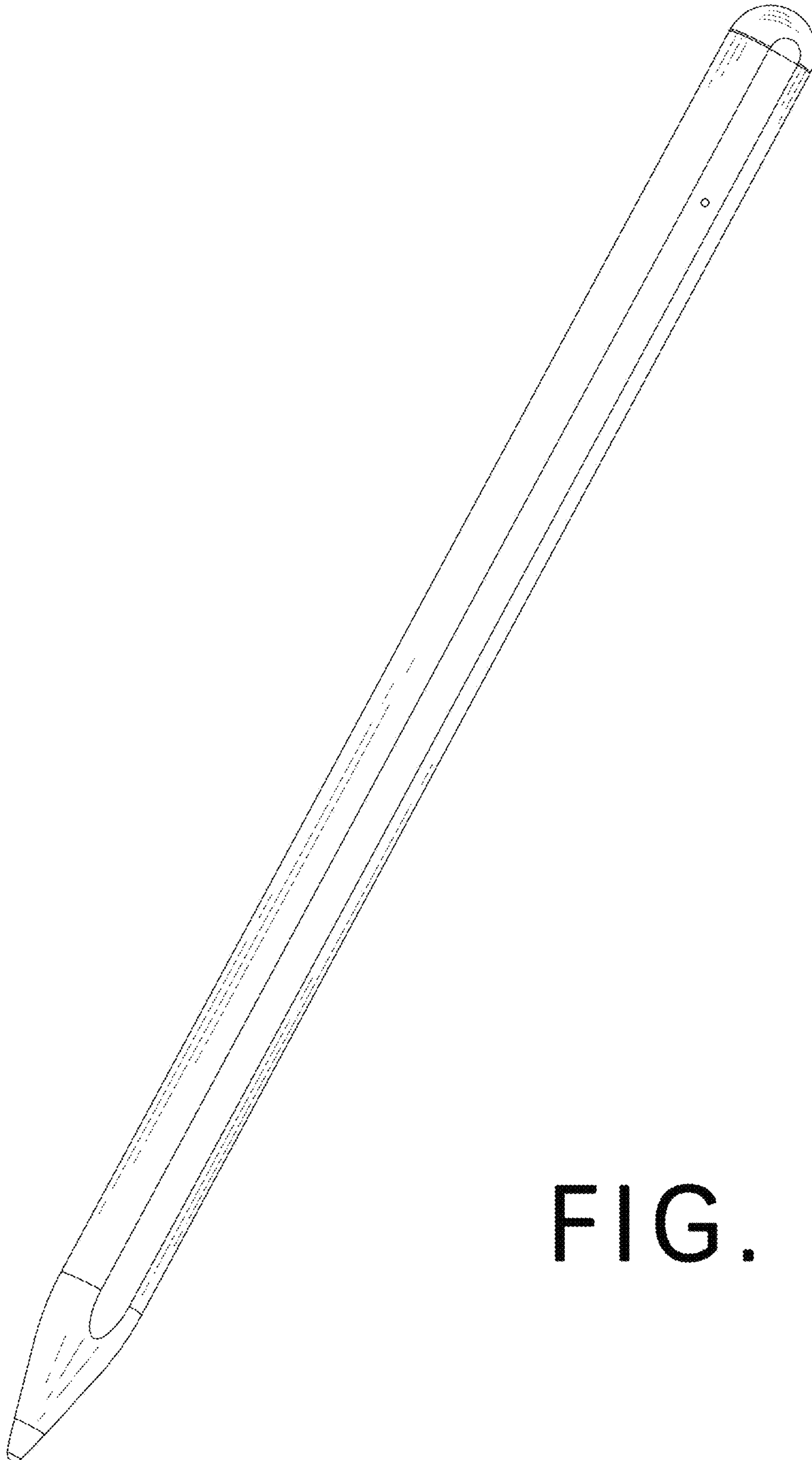

FIG. 2

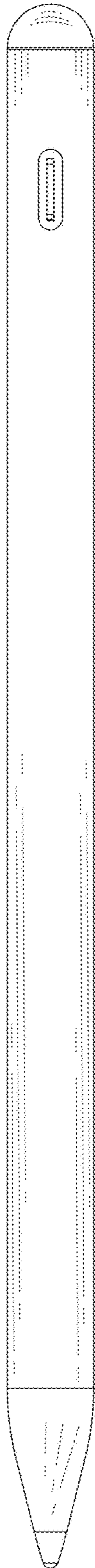

FIG. 3

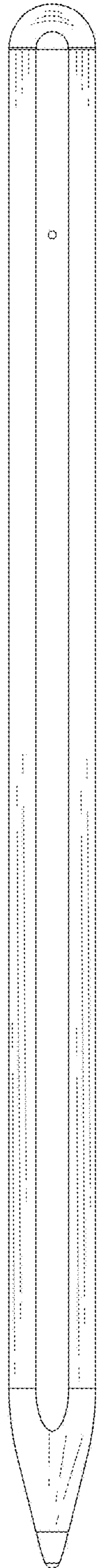

FIG. 4

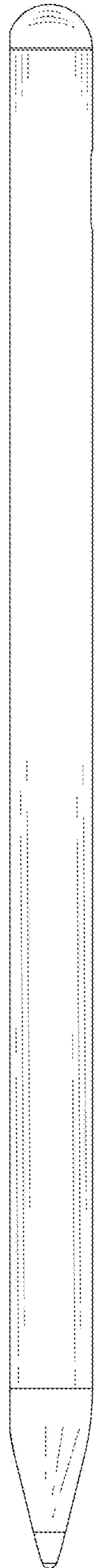
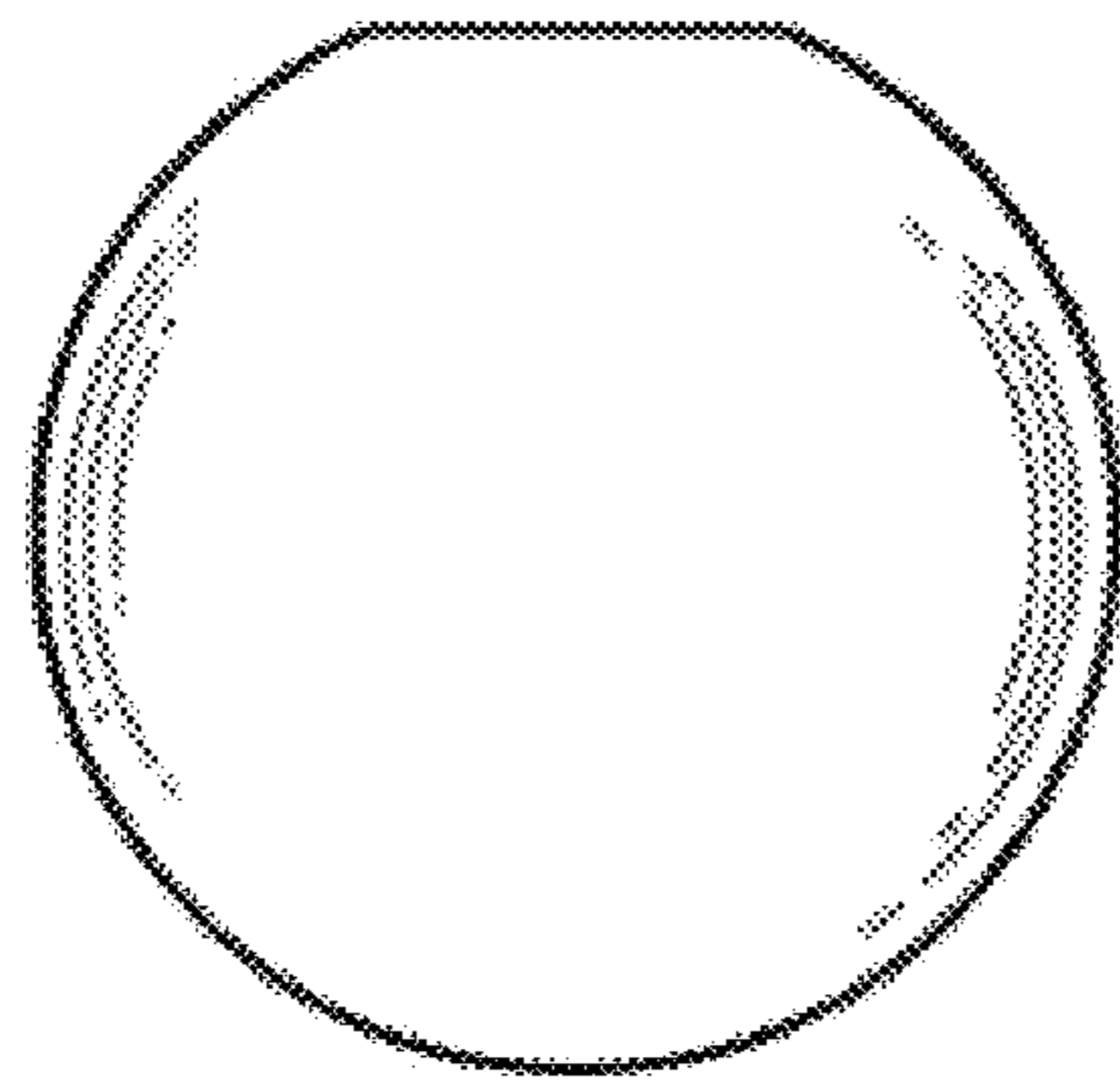

FIG. 5

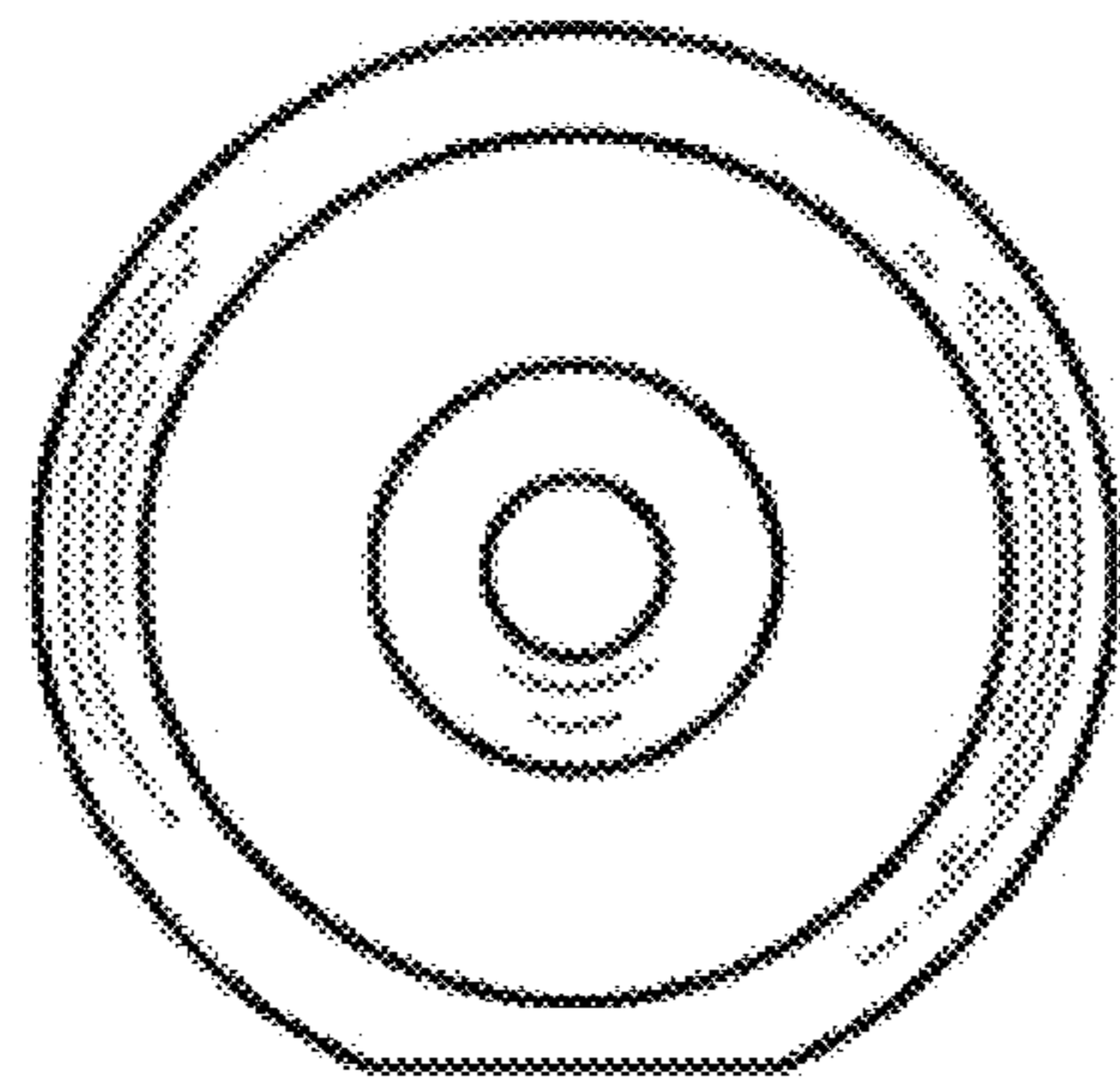

FIG. 6



**FIG. 7**





**FIG. 8**