

US00D936627S

(12) **United States Design Patent**
Lee et al.

(10) **Patent No.:** **US D936,627 S**

(45) **Date of Patent:** **** *Nov. 23, 2021**

(54) **MOBILE PHONE**

(71) Applicant: **LG ELECTRONICS INC.**, Seoul (KR)

(72) Inventors: **Jonghak Lee**, Seoul (KR); **Sojin Kim**, Seoul (KR); **Jinki Min**, Seoul (KR); **Hongkyu Park**, Seoul (KR); **Seunghyun Ji**, Seoul (KR)

(73) Assignee: **LG ELECTRONICS INC.**, Seoul (KR)

(*) Notice: This patent is subject to a terminal disclaimer.

(**) Term: **15 Years**

(21) Appl. No.: **29/708,976**

(22) Filed: **Oct. 10, 2019**

(30) **Foreign Application Priority Data**

Apr. 10, 2019 (JP) 2019-007909

(51) **LOC (13) Cl.** **14-03**

(52) **U.S. Cl.**
USPC **D14/138 AD; D14/341**

(58) **Field of Classification Search**
USPC D14/138 AD, 138 R, 138 AA, 341, 345, D14/346, 203.1, 203.3, 203.4, 203.7, 248,
(Continued)

(56) **References Cited**

U.S. PATENT DOCUMENTS

D536,684 S * 2/2007 Kim D14/138 AA
D551,647 S * 9/2007 Kim D14/138 AD
(Continued)

FOREIGN PATENT DOCUMENTS

CN 303428801 * 11/2015
JP D1370691 * 10/2009
(Continued)

OTHER PUBLICATIONS

Rollable display smartphones are coming NEXT!, GadgetMatch, youtube.com, dated Mar. 5, 2020, [online], [site visited Feb. 20, 2021]. Available from Internet, URL: <https://www.youtube.com/watch?v=uzExejMsVOY> (Year: 2020).*

(Continued)

Primary Examiner — Jeffrey D Asch

(74) *Attorney, Agent, or Firm* — Birch, Stewart, Kolasch & Birch, LLP

(57) **CLAIM**

The ornamental design for a mobile phone, as shown and described.

DESCRIPTION

FIG. 1 is a front perspective view of the mobile phone showing our new design;
FIG. 2 is a front view thereof;
FIG. 3 is a rear view thereof;
FIG. 4 is a left side view thereof;
FIG. 5 is a right side view thereof;
FIG. 6 is a top plan view thereof;
FIG. 7 is a bottom plan view thereof;
FIG. 8 is a rear perspective view thereof;
FIG. 9 is a rear perspective view showing the use state in which rear display part is operated, showing example displayed information;
FIG. 10 is a front perspective view in a condition that the claimed design has been expanded completely;
FIG. 11 is a front view of FIG. 10;
FIG. 12 is a rear view of FIG. 10;
FIG. 13 is a left side view of FIG. 10;
FIG. 14 is a right side view of FIG. 10;
FIG. 15 is a top plan view of FIG. 10;
FIG. 16 is a bottom plan view of FIG. 10; and,
FIG. 17 is a rear perspective view of FIG. 10.
The broken lines depict portions of the mobile phone, and example displayed information in FIG. 9, that form no part of the claimed design.

1 Claim, 17 Drawing Sheets

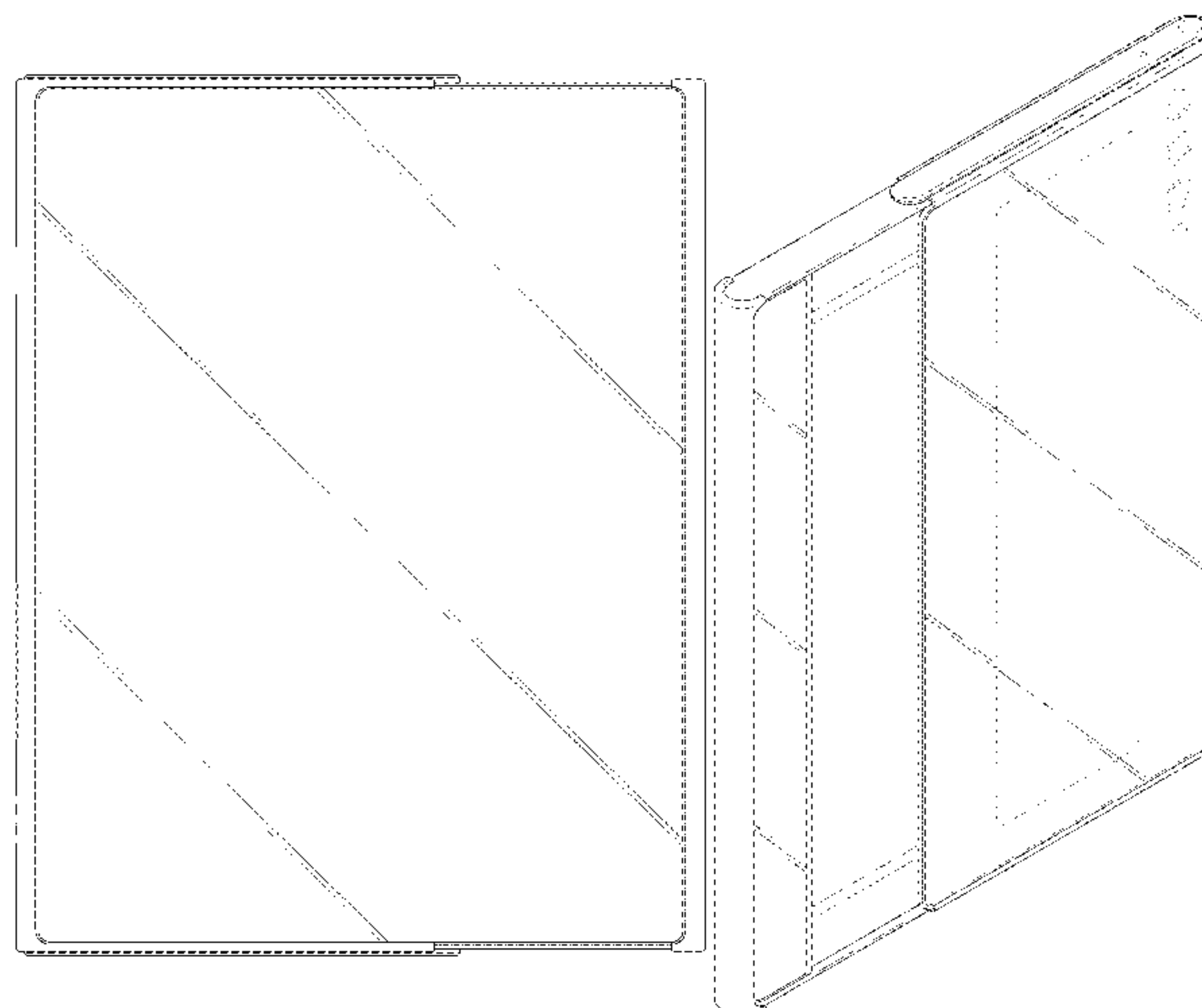

(58) **Field of Classification Search**

USPC D14/132, 501, 336, 496; D21/517;
D6/704; D16/241

CPC H04M 1/0237; H04M 1/206; H04M 1/208;
H04M 1/0241; H04M 1/0268; G06F
1/1652; G06F 1/1624

See application file for complete search history.

(56) **References Cited**

U.S. PATENT DOCUMENTS

D631,458 S * 1/2011 Liao D14/138 G
D698,341 S * 1/2014 Lee D14/248
8,711,566 B2 * 4/2014 O'Brien G06F 1/1624
361/724
D712,401 S * 9/2014 Lee D14/341
D716,253 S * 10/2014 Lee D14/138 AB
D722,036 S * 2/2015 Nam D14/138 G
D750,067 S * 2/2016 Park, II D14/341
D750,617 S * 3/2016 Akana D14/341
9,286,812 B2 * 3/2016 Bohn H04M 1/0268
D761,253 S * 7/2016 Yamazaki D14/341
D766,891 S * 9/2016 Hong D14/341
D768,594 S * 10/2016 Szeto D14/138 G
D778,869 S * 2/2017 Kim D14/138 G
D779,481 S * 2/2017 Jun D14/341
D795,825 S * 8/2017 Kim D14/138 R
D841,646 S * 2/2019 Son D14/345
D871,397 S * 12/2019 Seo D14/341
10,499,515 B2 * 12/2019 Lee H05K 1/0283
10,553,135 B2 * 2/2020 Lee G09F 9/301
D896,769 S * 9/2020 Lee D14/138 AD
D902,899 S * 11/2020 Seo D14/248
10,880,417 B1 * 12/2020 Song H04M 1/0237
D912,045 S * 3/2021 Han D14/341
10,936,017 B1 * 3/2021 Choi G06F 1/1686
10,955,876 B1 * 3/2021 Song G06F 1/1652
10,963,014 B1 * 3/2021 Park G06F 1/1679
11,009,912 B2 * 5/2021 Kim G06F 3/0485
D923,598 S * 6/2021 Lee D14/138 AD
11,043,191 B1 * 6/2021 Kang G09G 5/373
2008/0125171 A1 * 5/2008 Shin H04M 1/03
455/556.1
2009/0156264 A1 * 6/2009 Cho H04M 1/0235
455/566
2012/0314400 A1 * 12/2012 Bohn G06F 1/1652
362/97.1
2013/0058063 A1 * 3/2013 O'Brien G06F 1/1652
361/807
2014/0194165 A1 * 7/2014 Hwang G06F 1/1652
455/566
2016/0041716 A1 * 2/2016 Richardson G06F 3/0483
345/173
2016/0274718 A1 * 9/2016 Burr G06F 1/1694
2017/0364119 A1 * 12/2017 Lee G06F 1/1652
2018/0014417 A1 * 1/2018 Seo H05K 1/189
2018/0077808 A1 * 3/2018 Seo G06F 3/04164
2018/0188778 A1 * 7/2018 Shin G06F 1/1652
2018/0196476 A1 * 7/2018 Kang G06F 1/1647
2018/0373408 A1 * 12/2018 Lee G06F 1/165
2020/0022271 A1 * 1/2020 Park G06F 1/1626
2020/0033913 A1 * 1/2020 Yang G06F 1/1624

2020/0174522 A1 * 6/2020 Lim A45C 13/20
2020/0253063 A1 * 8/2020 Jiang G06F 1/1652
2020/0264660 A1 * 8/2020 Song G06F 1/1686
2020/0264826 A1 * 8/2020 Kwon G06F 1/1681
2020/0267246 A1 * 8/2020 Song H05K 1/148
2020/0267247 A1 * 8/2020 Song H04M 1/0237
2020/0341514 A1 * 10/2020 Li G06F 1/1647
2020/0348727 A1 * 11/2020 Lee G06F 1/1626
2020/0383214 A1 * 12/2020 Kim H05K 5/0217
2021/0044683 A1 * 2/2021 He H04M 1/0268
2021/0072796 A1 * 3/2021 Kim G06F 1/16
2021/0181801 A1 * 6/2021 Yin H04M 1/0237
2021/0185835 A1 * 6/2021 Song H05K 5/0017
2021/0201709 A1 * 7/2021 Lee G06F 1/1652

FOREIGN PATENT DOCUMENTS

JP D1476428 * 8/2013
WO D203815-001 * 11/2019
WO D202678-001 * 12/2019

OTHER PUBLICATIONS

LG's Rollable Phone is becoming a REALITY!, TechAvid youtube.com, dated Dec. 2, 2020, [online], [site visited Feb. 20, 2021]. Available from Internet, URL: <https://www.youtube.com/watch?v=tZK6a4-GunE> (Year: 2020).*

Oppo Rollable Display Phone Hands-on Experience, Creator Studio, youtube.com, dated Nov. 17, 2020, [online], [site visited Feb. 20, 2021]. Available from Internet, URL: <https://www.youtube.com/watch?v=CUTmYqJcVpQ> (Year: 2020).*

TCL's sliding-screen concept phone, CNET, youtube.com, dated Mar. 5, 2020, [online], [site visited Feb. 20, 2021]. Available from Internet, URL: <https://www.youtube.com/watch?v=kl5H7NhNTg> (Year: 2020).*

Oppo X 2021 Rollable Concept Phone Truly Looks Like the Next Big Thing, by Kelvin, Nov. 18, 2020, Concept Phones,[online], [site visited Feb. 20, 2021]. Available from Internet, URL: <https://www.concept-phones.com/news/oppo-x-2021-rollable-concept-phone-truly-looks-like-the-next-big-thing/> (Year: 2020).*

The Scroll is Back! Flexible Device Has Scrollable Part Coming Out, by Kelvin, Mar. 14, 2018, Concept Phones, [online], [site visited Feb. 20, 2021]. Available from Internet, URL: <https://www.concept-phones.com/samsung/scroll-flexible-device-scrollable-part-coming/> (Year: 2018).*

LG Rollable Phone Versus TCL Rollable Phone; Who Won CES 2021?, by Kelvin, Jan. 14, 2021, Concept Phones, [online], [site visited Feb. 20, 2021]. Available from Internet, URL: <https://www.concept-phones.com/lg/lg-rollable-phone-versus-tcl-rollable-phone-who-won-ces-2021/> (Year: 2021).*

Shh, Samsung will demo phone with a slide-out display at a secret meeting today, Daniel Petrov, Jan. 7, 2020, PhoneArena, [online], [site visited Feb. 20, 2021]. Available from Internet, URL: https://www.phonearena.com/news/samsung-slide-display-phone-ces-2020_id121415 (Year: 2020).*

Top 5 Rollable Phones with Sliding screens 2021 | Rollable Smartphones | Rolling Display Phones, Top 5 Gadgets, youtube.com, dated Nov. 25, 2020, [online], [site visited Feb. 20, 2021]. Available from Internet, URL: <https://www.youtube.com/watch?v=ZjofT-71k8U> (Year: 2020).*

* cited by examiner

FIG. 1

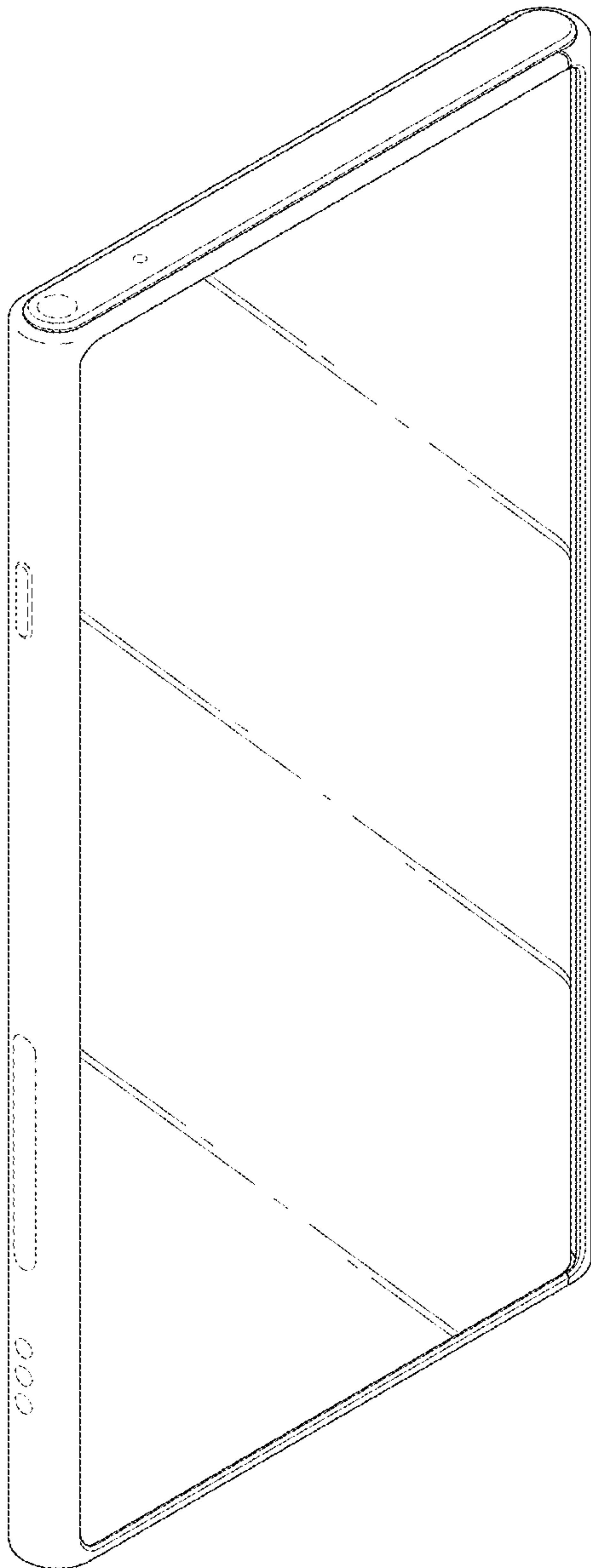

FIG. 2

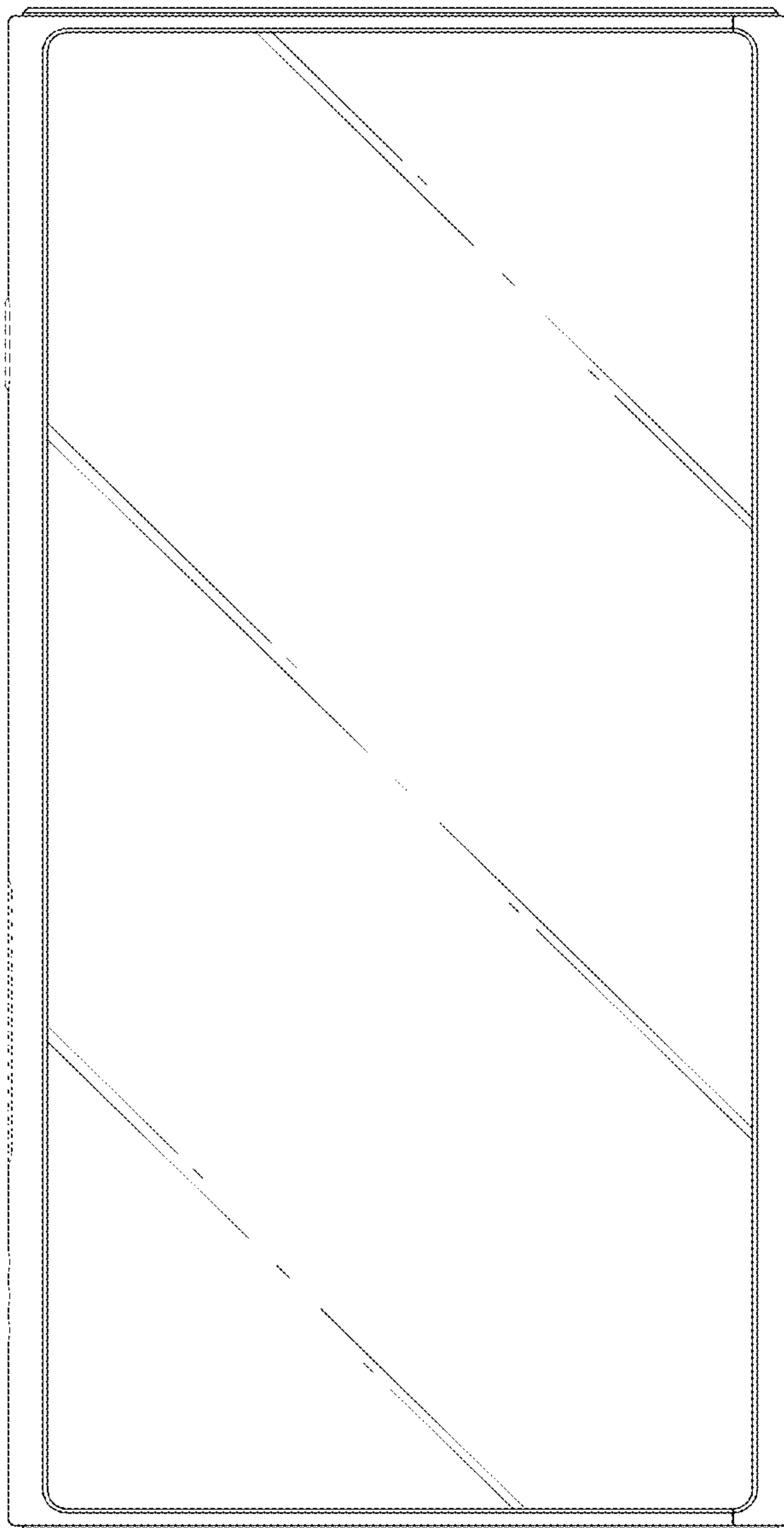

FIG. 3

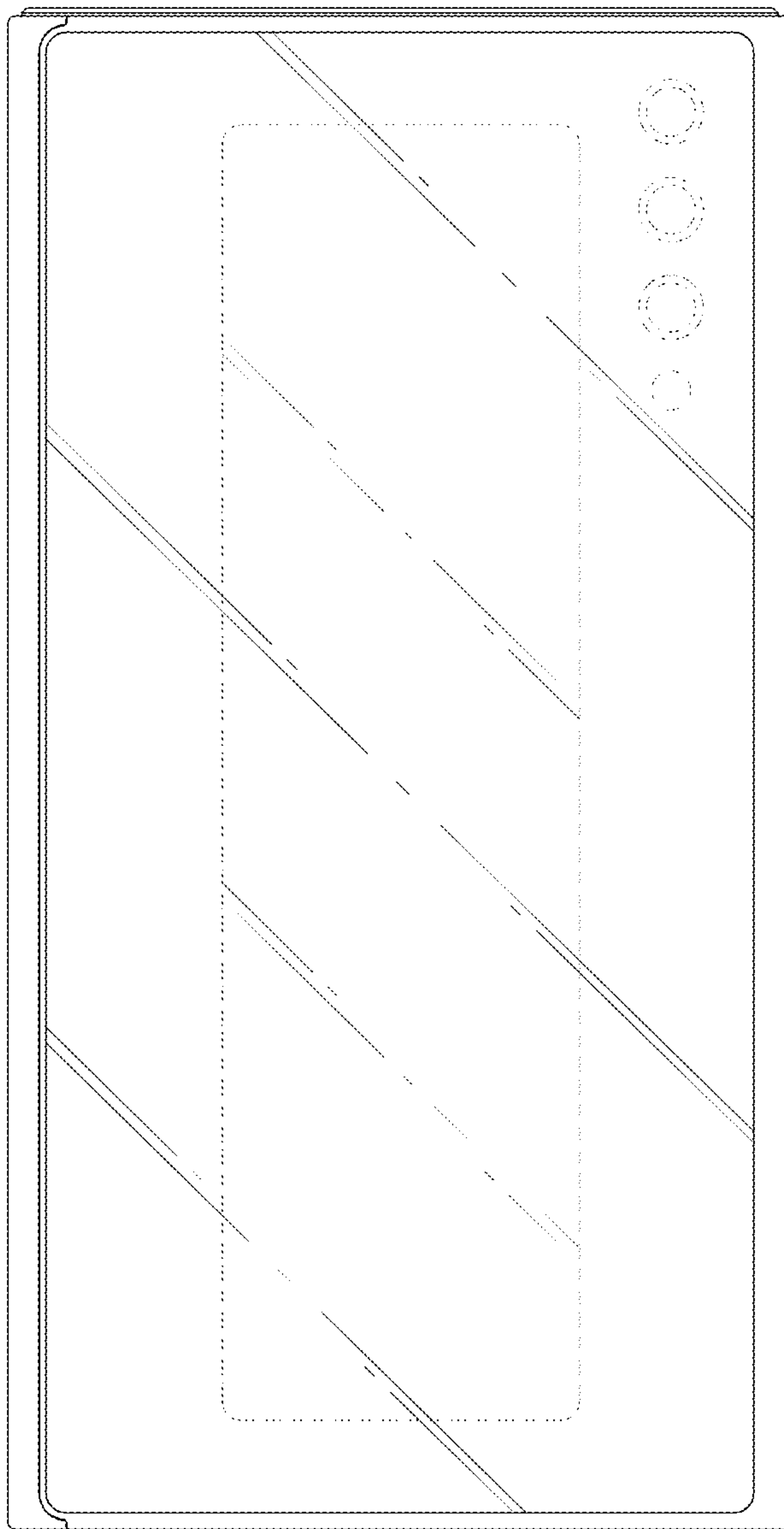

FIG. 4

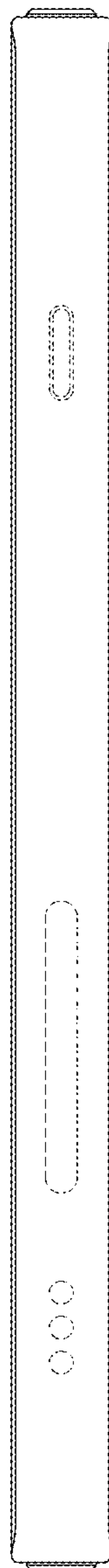

FIG. 5



FIG. 6

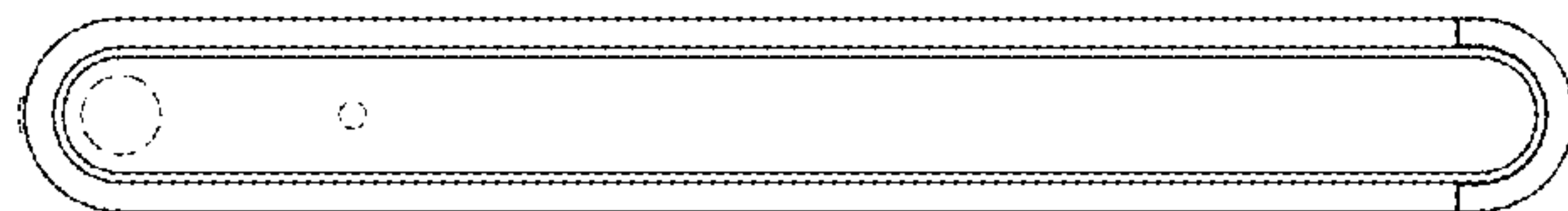

FIG. 7

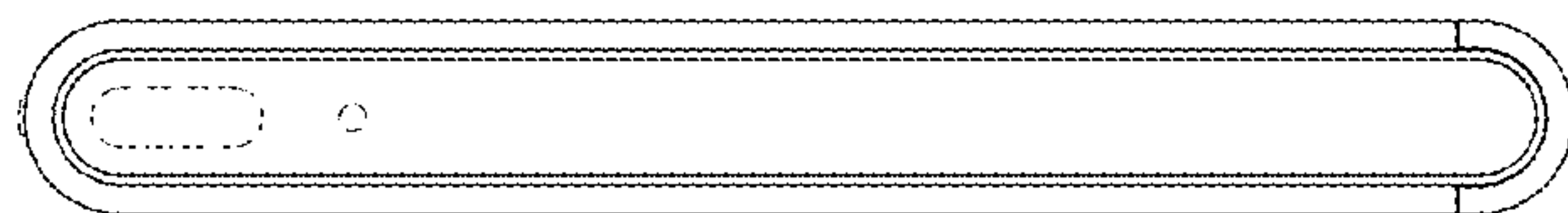

FIG. 8

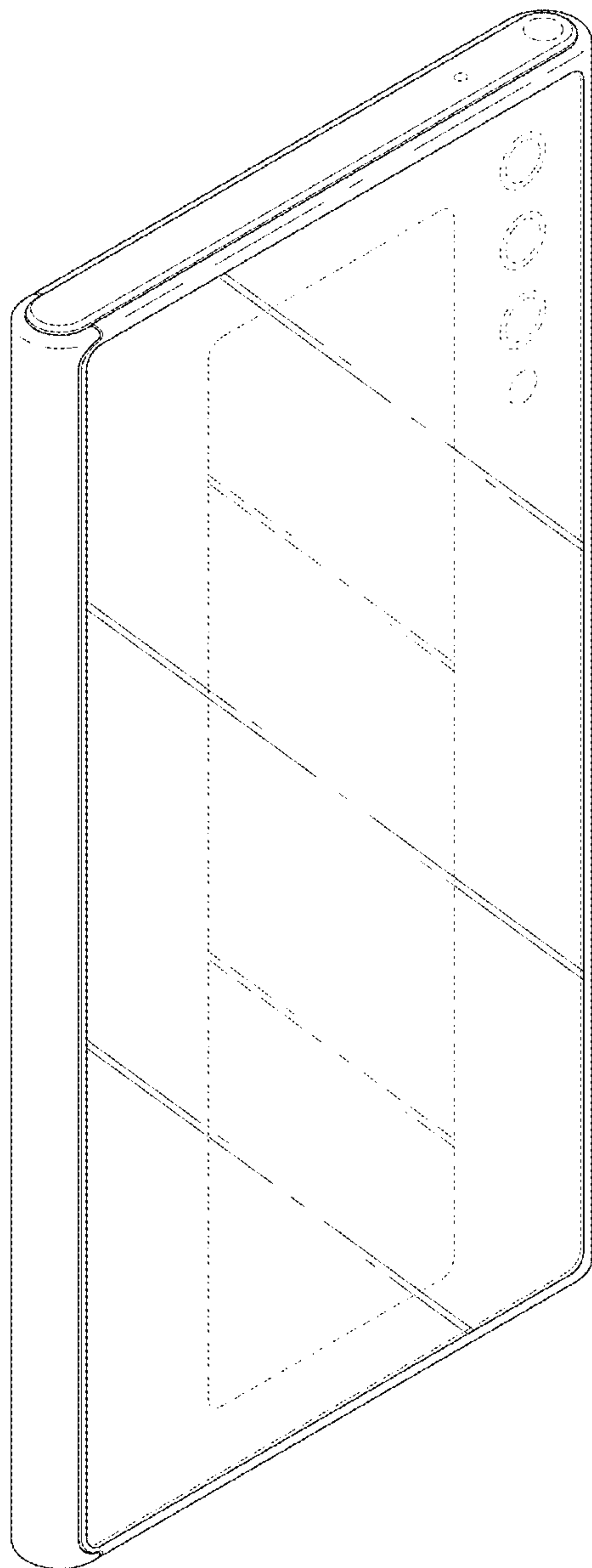

FIG. 9

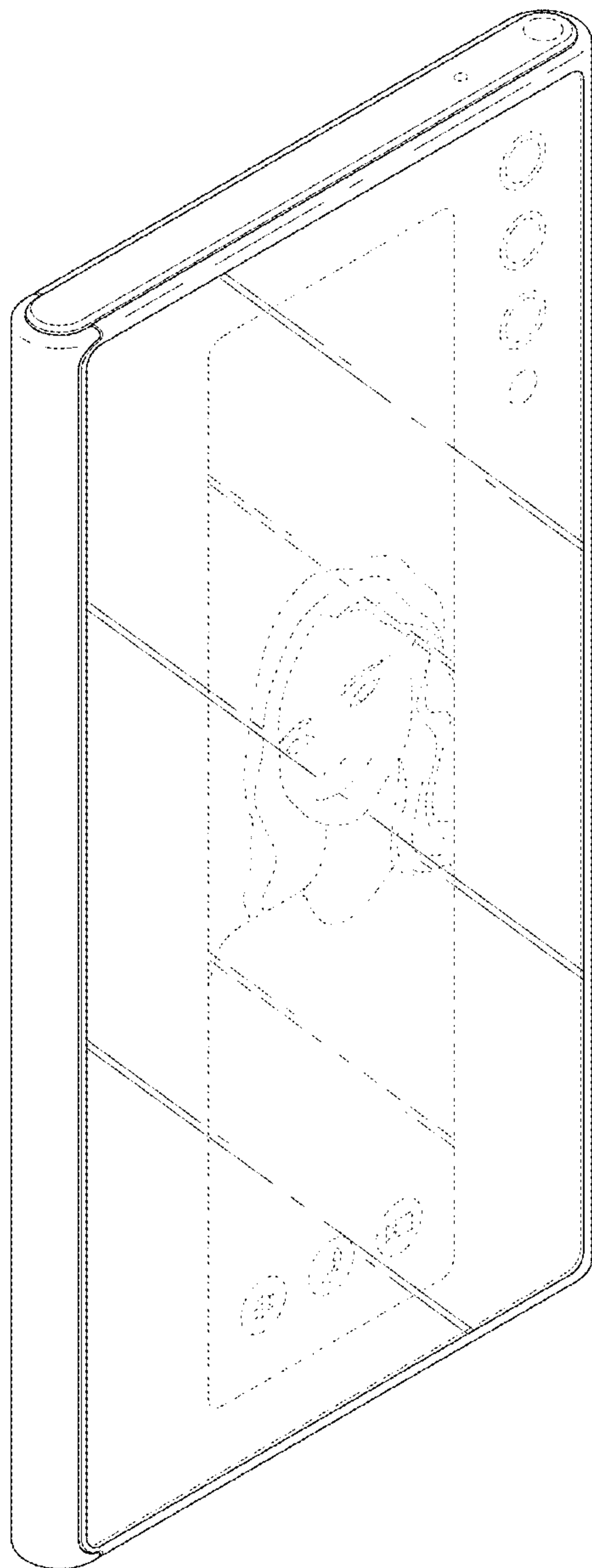

FIG. 10

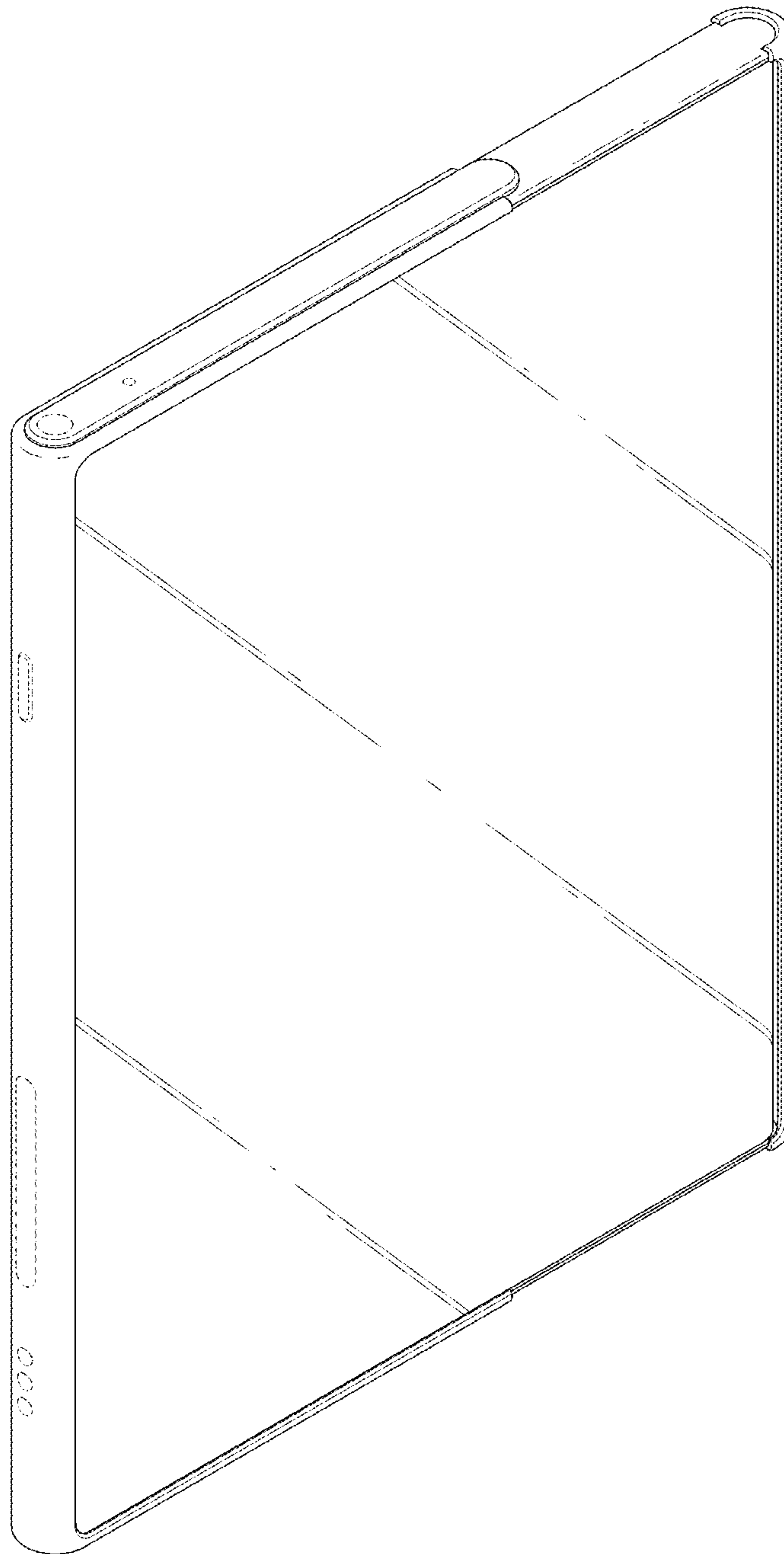

FIG. 11

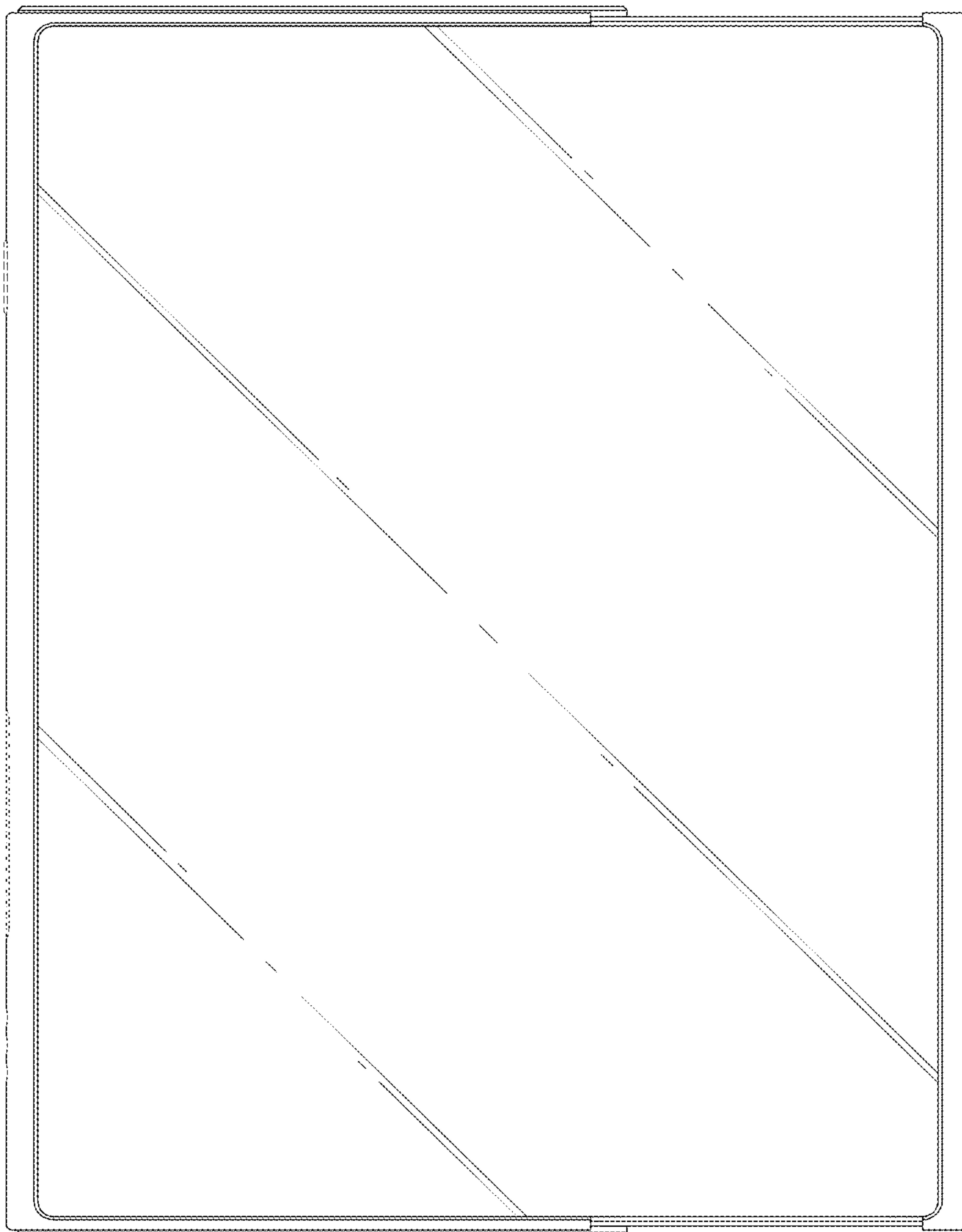

FIG. 12

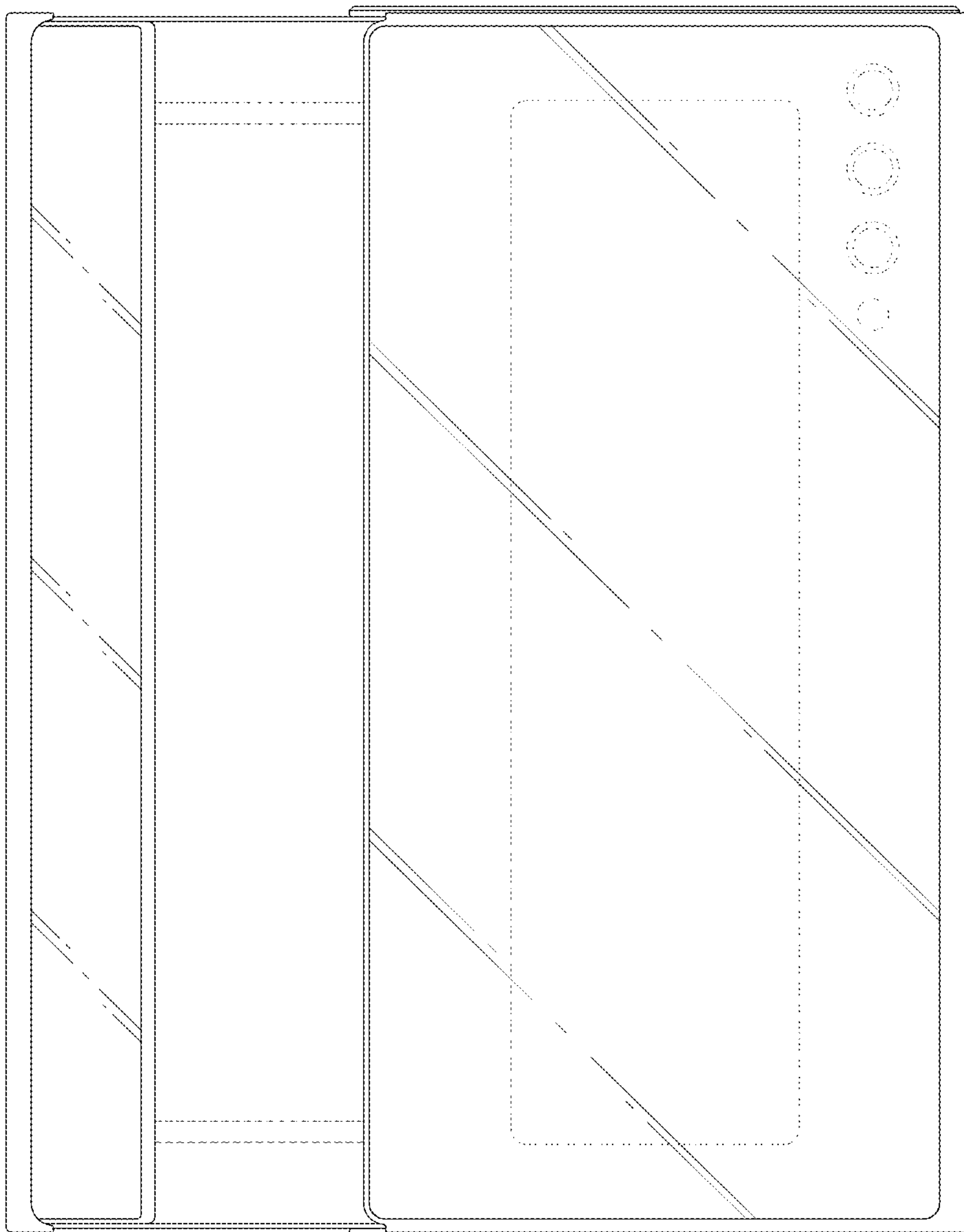

FIG. 13

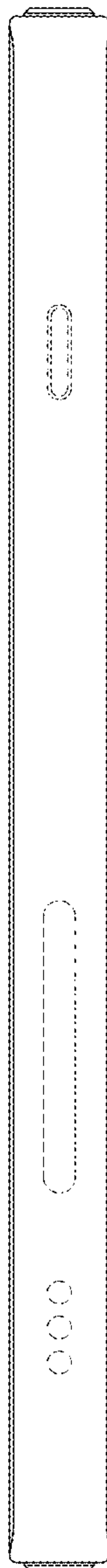

FIG. 14



FIG. 15

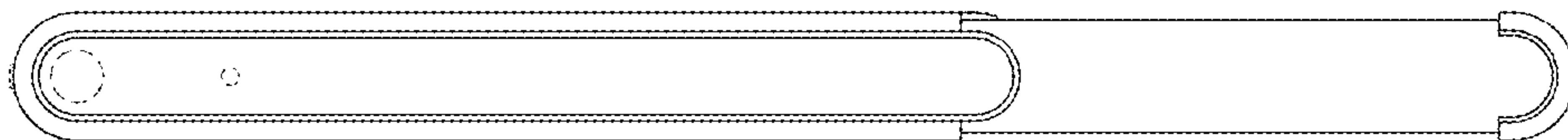

FIG. 16

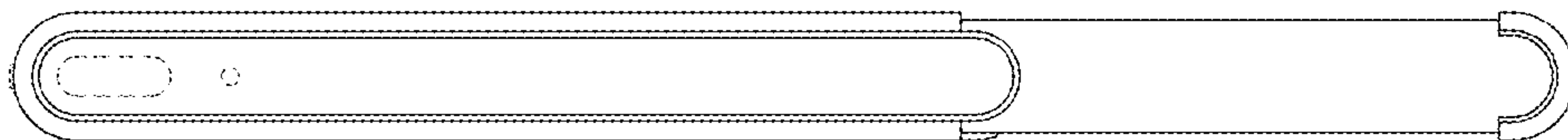

FIG. 17

