



US00D936577S

(12) **United States Design Patent**  
**Huang**

(10) **Patent No.:** **US D936,577 S**

(45) **Date of Patent:** **\*\* Nov. 23, 2021**

(54) **STYLUS CHARGER**

(71) Applicant: **Fengbo Huang**, Heyuan (CN)

(72) Inventor: **Fengbo Huang**, Heyuan (CN)

(\*\*) Term: **15 Years**

(21) Appl. No.: **29/727,993**

(22) Filed: **Mar. 16, 2020**

(51) **LOC (13) Cl.** ..... **13-02**

(52) **U.S. Cl.**  
USPC ..... **D13/108**

(58) **Field of Classification Search**  
USPC ..... D13/107-110, 118, 119, 184, 199  
CPC .. Y02E 60/12; H01R 13/6675; H01M 2/1022;  
H01M 2/1055; H01M 10/44; H01M  
10/46; H01M 10/425; H02J 2001/008;  
H02J 3/32; H02J 3/008; H02J 7/0027;  
H02J 7/0013; H02J 7/0054; H02J 7/00;  
B60R 16/03

See application file for complete search history.

(56) **References Cited**

**U.S. PATENT DOCUMENTS**

D497,777 S	*	11/2004	Sanders	.....	D7/603
D516,022 S	*	2/2006	Winkler	.....	D13/108
D563,314 S	*	3/2008	Kingston	.....	D13/108
D576,547 S	*	9/2008	Kling	.....	D13/108
D621,347 S	*	8/2010	Aulwes	.....	D13/108

D621,665 S	*	8/2010	Lion	.....	D7/603
D623,322 S	*	9/2010	Wallach	.....	D26/38
D658,580 S	*	5/2012	Gebski	.....	D13/108
D835,945 S	*	12/2018	Verellen	.....	D7/603
D843,178 S	*	3/2019	Furneaux	.....	D7/603
D870,040 S	*	12/2019	Wu	.....	D13/108
D883,200 S	*	5/2020	Wong	.....	D13/108
2021/0052009 A1	*	2/2021	Slama	.....	H02J 50/10

\* cited by examiner

*Primary Examiner* — Christy Nemeth

(74) *Attorney, Agent, or Firm* — W&K IP

(57) **CLAIM**

The ornamental design for a stylus charger, as shown and described.

**DESCRIPTION**

FIG. 1 is a perspective view of a stylus charger;  
FIG. 2 is a front elevational view thereof;  
FIG. 3 is a rear elevational view thereof;  
FIG. 4 is a left elevational view thereof;  
FIG. 5 is a right elevational view thereof;  
FIG. 6 is a top plan view thereof; and,  
FIG. 7 is a bottom plan view thereof.  
The broken lines in the drawings illustrate portions of the stylus charger that form no part of the claimed design.

**1 Claim, 7 Drawing Sheets**

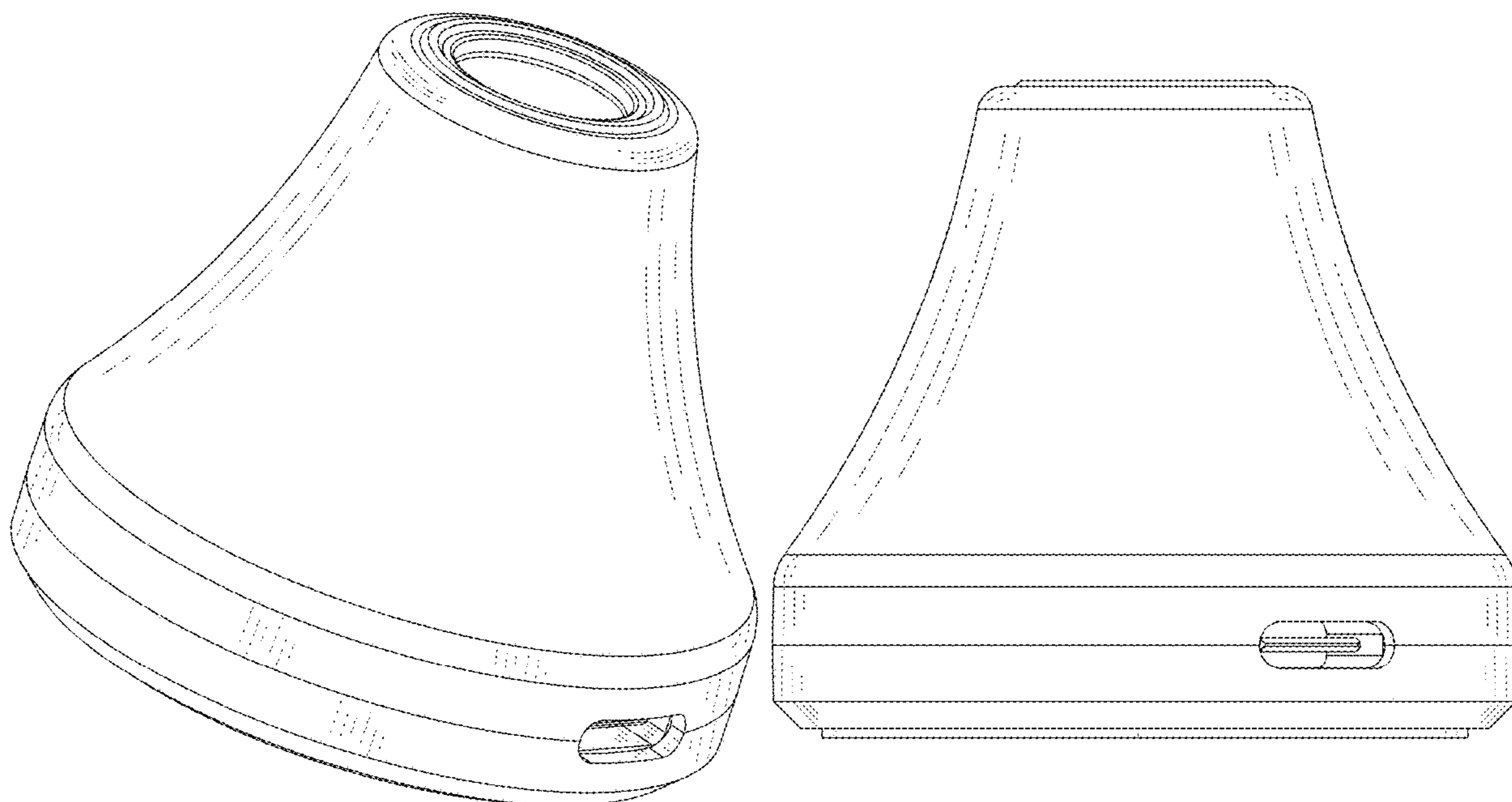

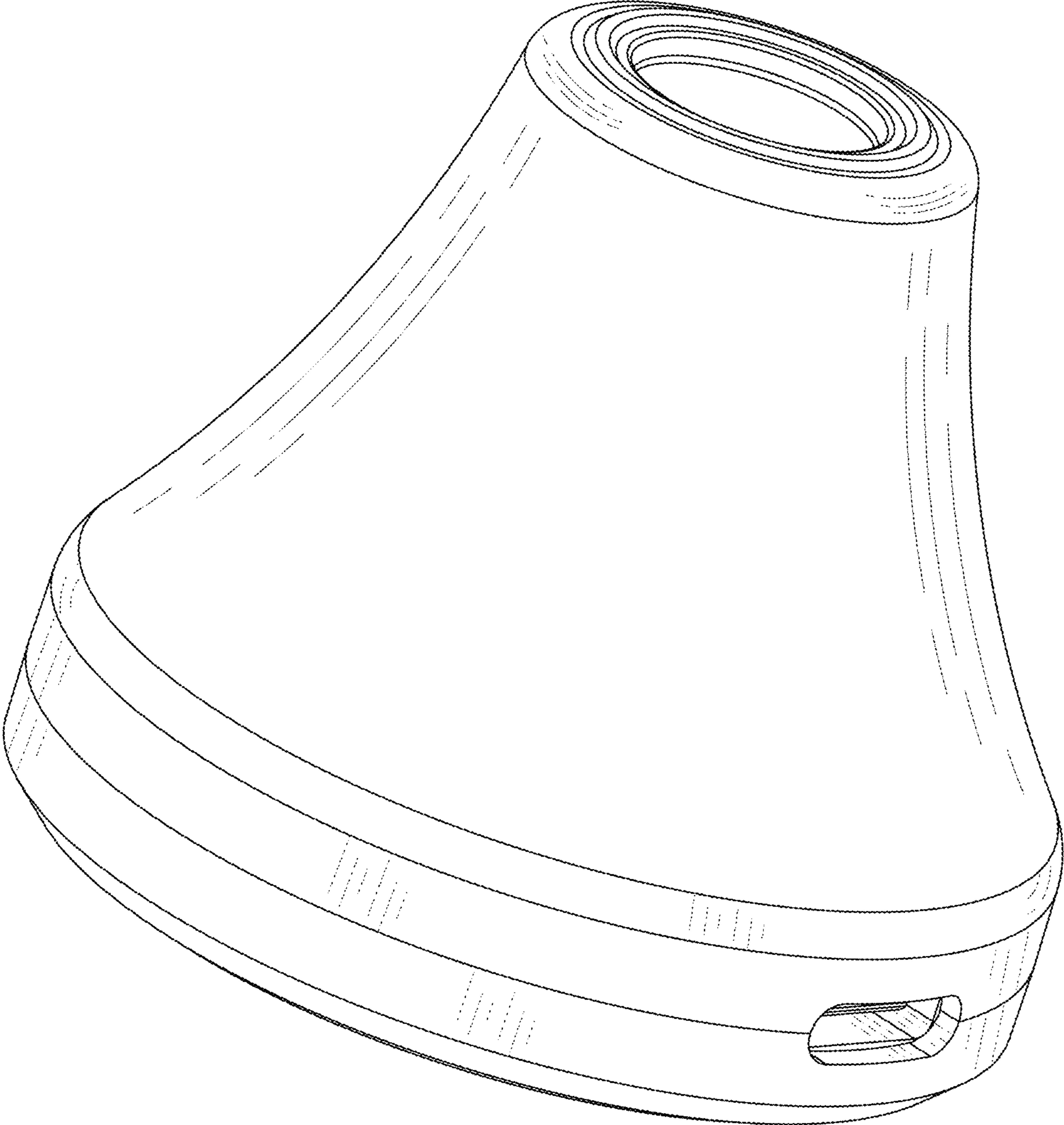

FIG. 1

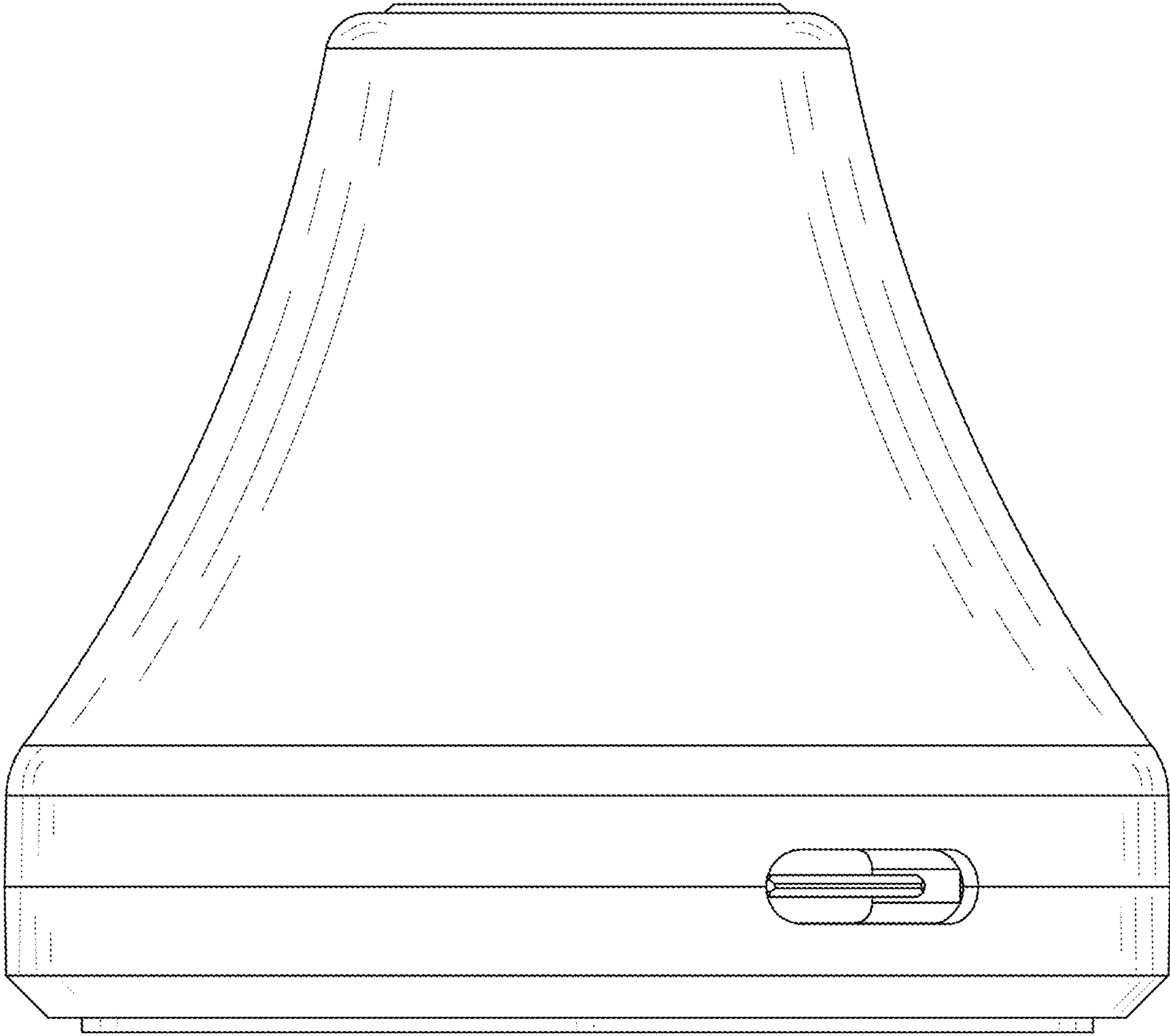

FIG. 2

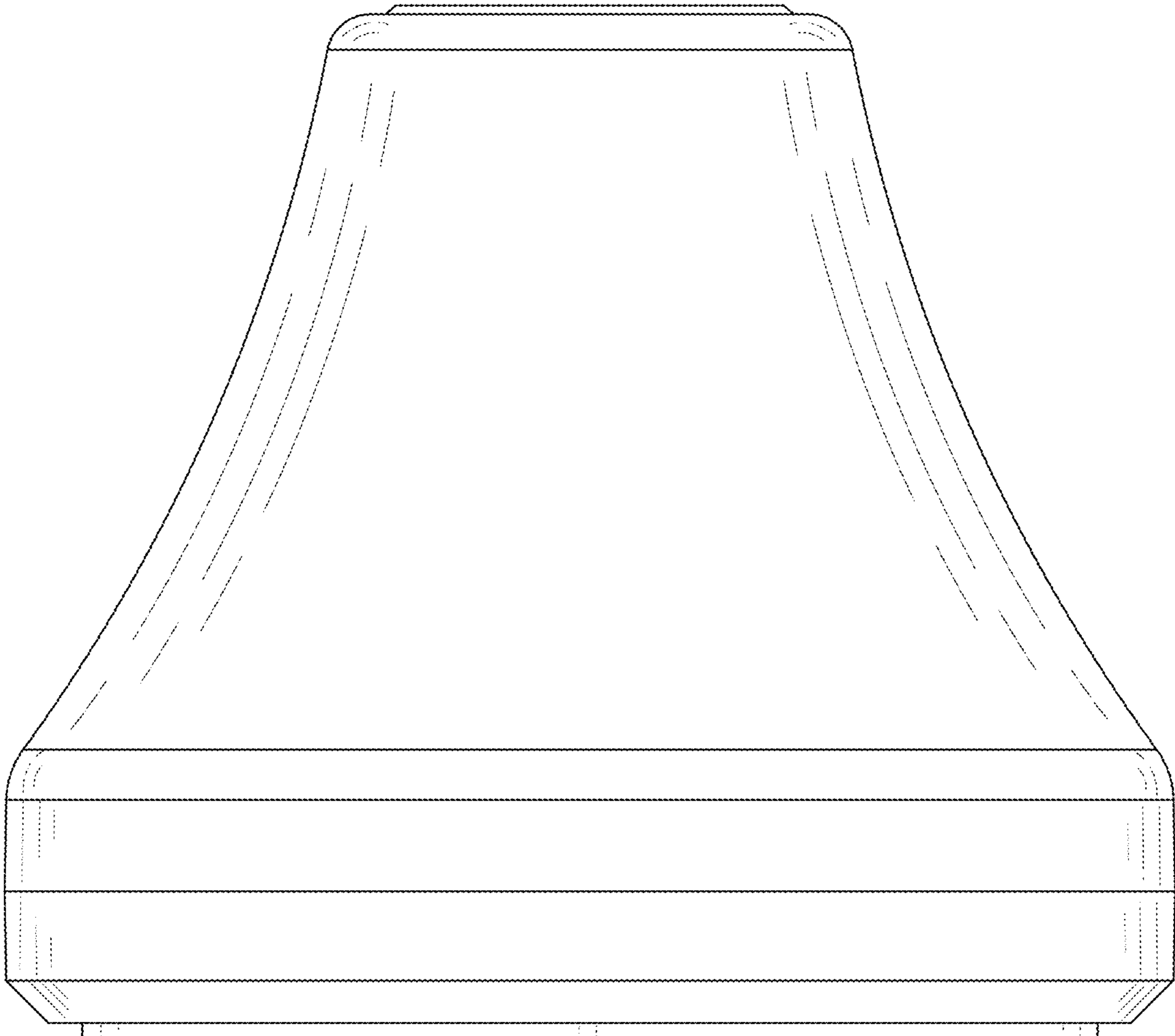

FIG. 3

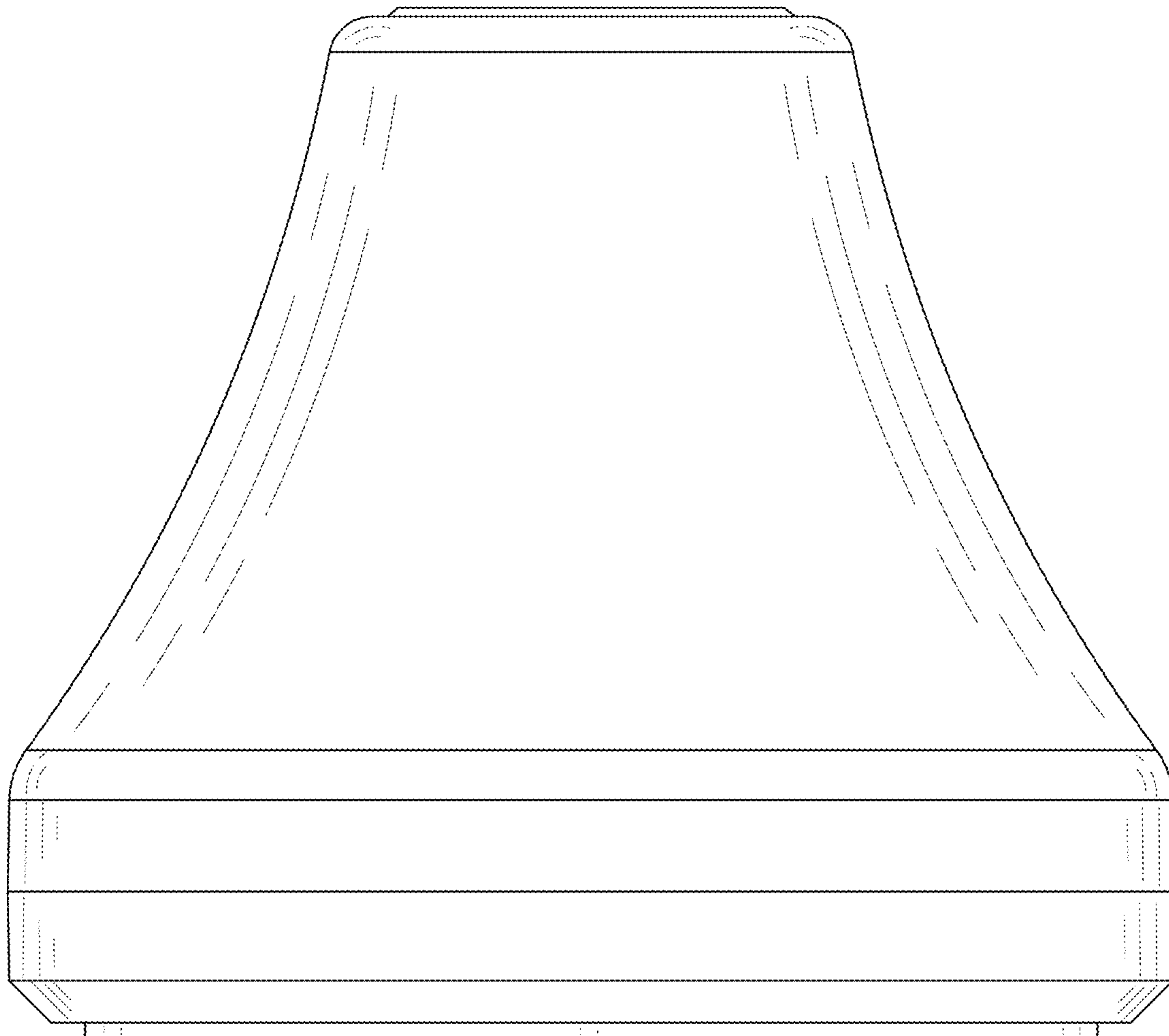

FIG. 4

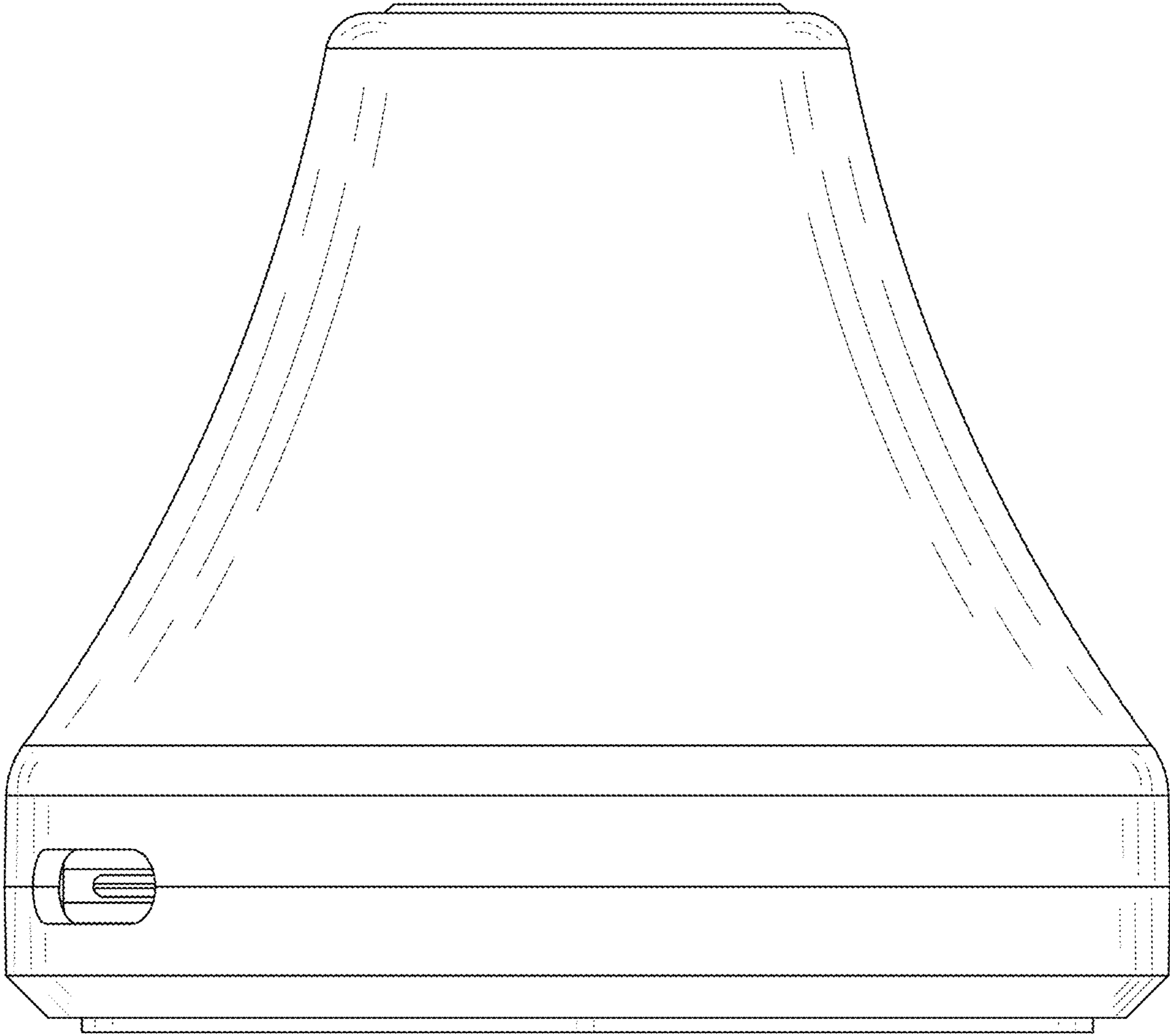

FIG. 5

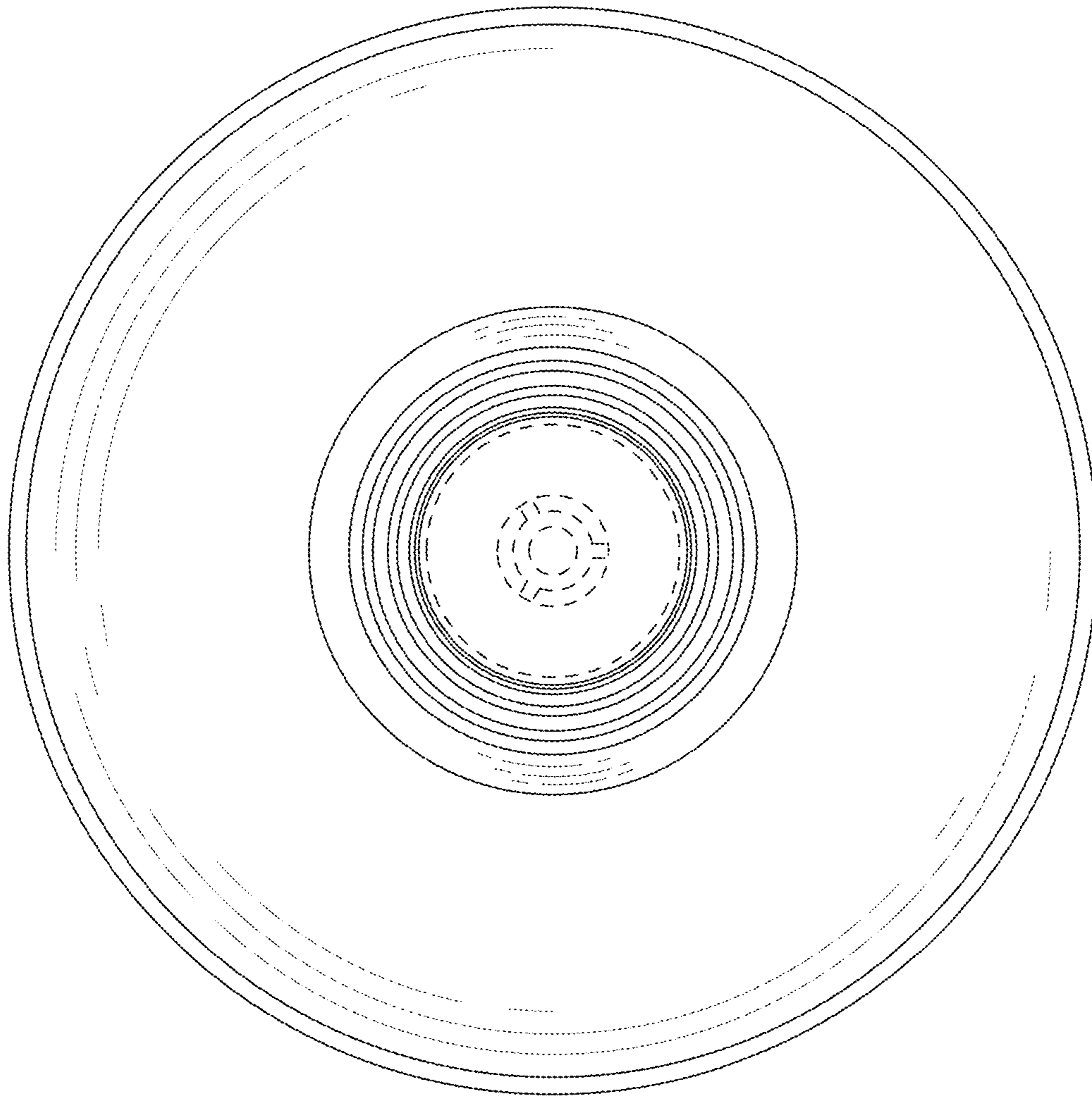

FIG. 6

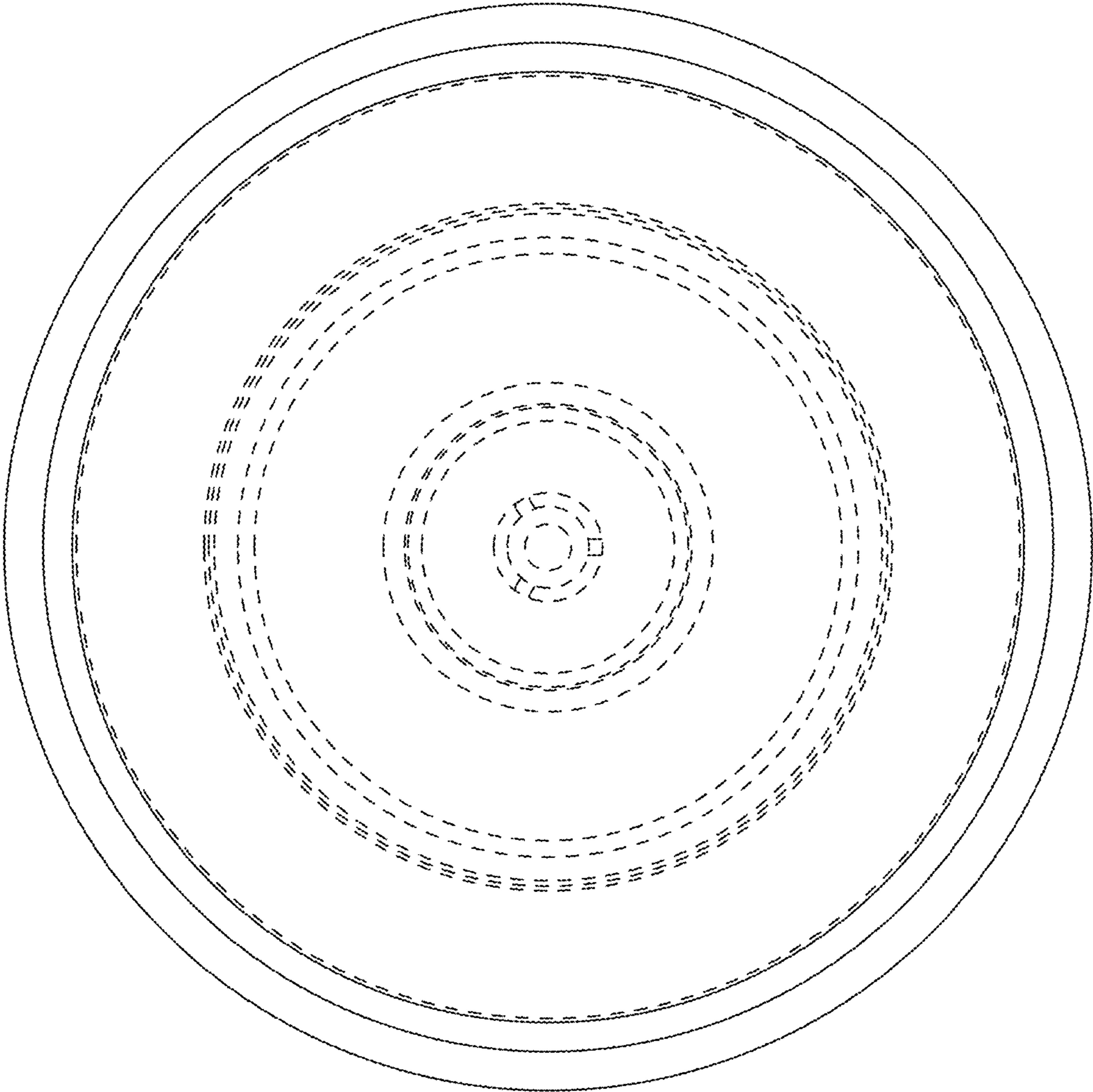

FIG. 7