



US00D936501S

(12) **United States Design Patent**
Wojciechowski et al.

(10) **Patent No.:** **US D936,501 S**

(45) **Date of Patent:** **** Nov. 23, 2021**

(54) **LEVEL**
(71) Applicant: **Johnson Level & Tool Mfg. Co., Inc.**,
Mequon, WI (US)
(72) Inventors: **Timothy J. Wojciechowski**, Hubertus,
WI (US); **David Mencil**, Menomonee
Falls, WI (US)
(73) Assignee: **Johnson Level & Tool Mfg. Co., Inc.**,
Mequon, WI (US)
(**) Term: **15 Years**

D555,523 S 11/2007 Nickel et al.
D598,309 S 8/2009 Gofer
D633,400 S 3/2011 Wojciechowski et al.
D634,221 S 3/2011 Wojciechowski et al.
8,914,987 B2 12/2014 Sanchez
D750,511 S * 3/2016 Wojciechowski G01C 9/36
D10/69
D753,281 S * 4/2016 Baston G01C 25/00
D23/382
D813,060 S * 3/2018 Wojciechowski D10/69
D825,353 S * 8/2018 Wojciechowski D10/69
10,731,982 B2 * 8/2020 Neitzell G01C 9/36
10,928,197 B2 * 2/2021 Wojciechowski G01C 9/34
2016/0138918 A1 * 5/2016 Neitzell G01C 25/00
33/381

(21) Appl. No.: **29/706,799**
(22) Filed: **Sep. 24, 2019**
(51) **LOC (13) Cl.** **10-04**
(52) **U.S. Cl.**
USPC **D10/69**
(58) **Field of Classification Search**
USPC D10/69
CPC . G01C 9/00; G01C 9/005; G01C 9/02; G01C
9/04; G01C 9/06; G01C 9/08; G01C
9/10; G01C 9/12; G01C 9/14; G01C
9/16; G01C 9/18; G01C 9/20; G01C
9/22; G01C 9/24; G01C 9/26; G01C
9/28; G01C 9/30; G01C 9/32; G01C
9/34; G01C 9/36; G01C 2009/005; G01C
2009/062; G01C 2009/064; G01C
2009/066; G01C 2009/068; G01C
2009/102; G01C 2009/105; G01C
2009/107; G01C 2009/182; G01C
2009/185; G01C 2009/187
See application file for complete search history.

* cited by examiner

Primary Examiner — Antoine Duval Davis

(74) *Attorney, Agent, or Firm* — Boyle Fredrickson S.C.

(56) **References Cited**

U.S. PATENT DOCUMENTS

D521,399 S 5/2006 Johnson et al.
D537,000 S 2/2007 Kim

(57) **CLAIM**

The ornamental design of a level, as shown and described.

DESCRIPTION

FIG. 1 is an isometric view of a level incorporating our new design, wherein the break lines indicate indeterminate length, and wherein the portions illustrated in phantom form no part of the claimed design;
FIG. 2 is a first side elevation view thereof;
FIG. 3 is a second, opposite side elevation view thereof;
FIG. 4 is a first end elevation view thereof;
FIG. 5 is a second, opposite end elevation view thereof;
FIG. 6 is a top plan view thereof; and,
FIG. 7 is a bottom plan view thereof.

1 Claim, 6 Drawing Sheets

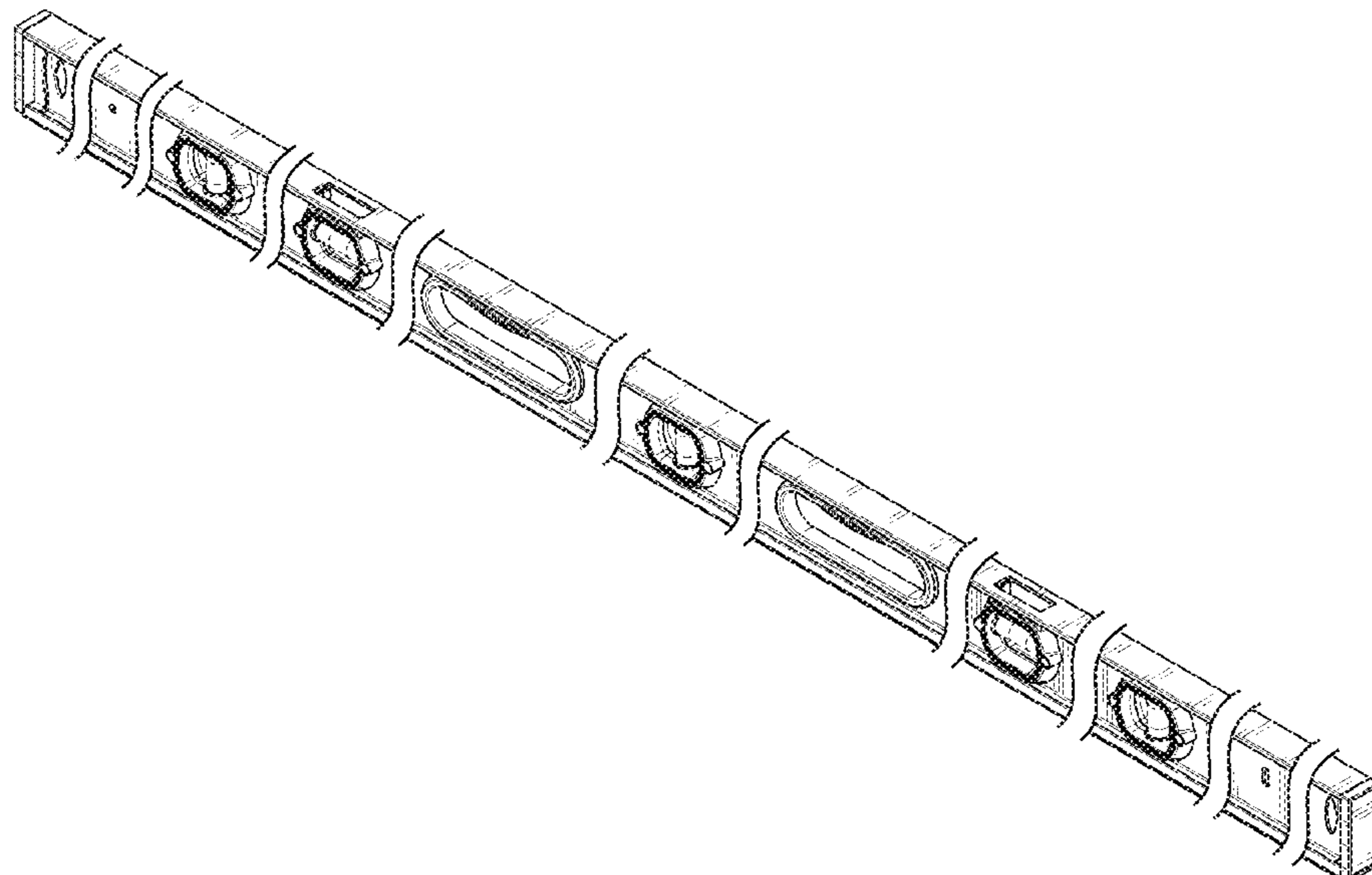

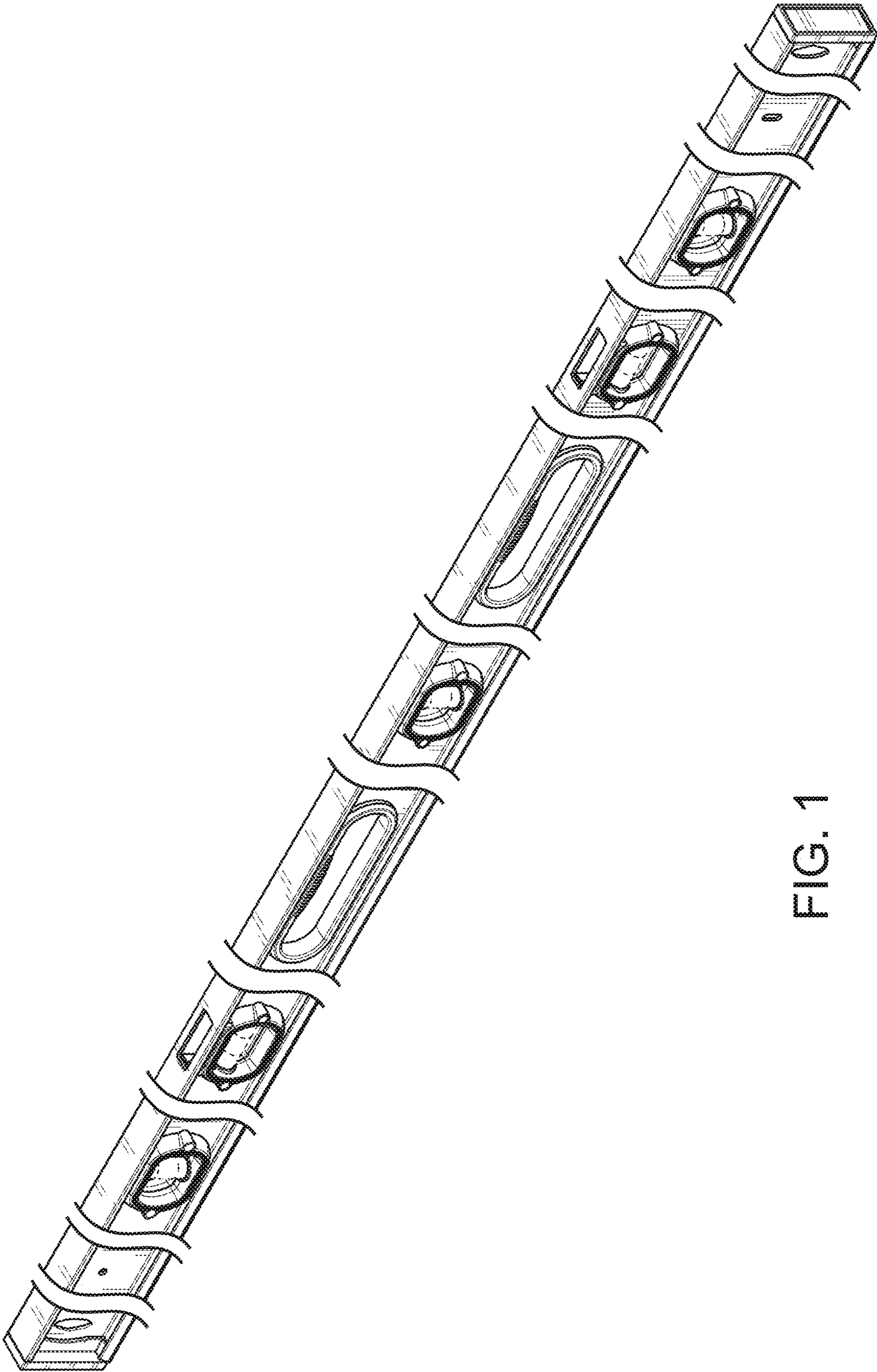

FIG. 1

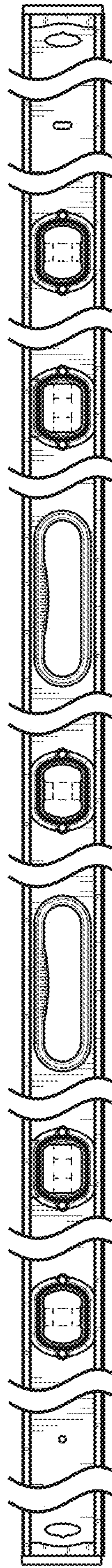

FIG. 2

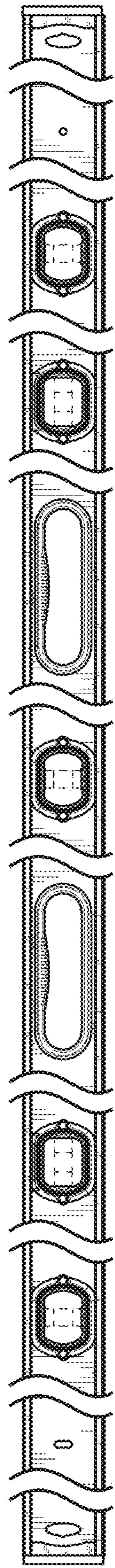

FIG. 3



FIG. 5

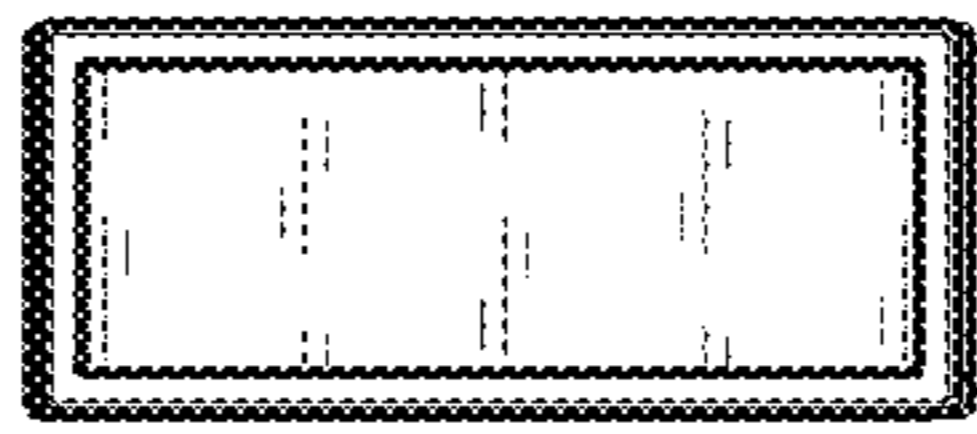

FIG. 4

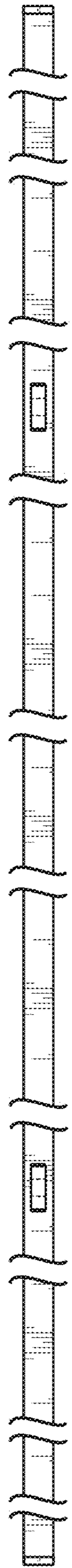

FIG. 6

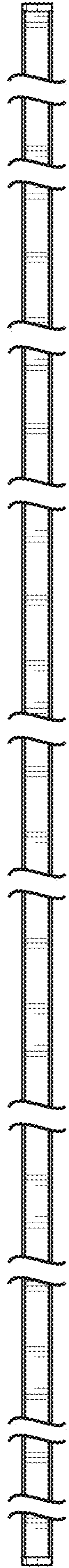

FIG. 7