



US00D936496S

(12) **United States Design Patent** (10) **Patent No.:** **US D936,496 S**
Wojciechowski et al. (45) **Date of Patent:** **** Nov. 23, 2021**

(54) **TORPEDO LEVEL**
(71) Applicant: **Johnson Level & Tool Mfg. Co., Inc.**,
Mequon, WI (US)
(72) Inventors: **Timothy J. Wojciechowski**, Hubertus,
WI (US); **David Mencil**, Menomonee
Falls, WI (US)
(73) Assignee: **Johnson Level & Tool Mfg. Co., Inc.**,
Mequon, WI (US)
(**) Term: **15 Years**
(21) Appl. No.: **29/706,785**
(22) Filed: **Sep. 24, 2019**
(51) **LOC (13) Cl.** **10-04**
(52) **U.S. Cl.**
USPC **D10/69**
(58) **Field of Classification Search**
USPC D10/69
CPC . G01C 9/00; G01C 9/005; G01C 9/02; G01C
9/04; G01C 9/06; G01C 9/08; G01C
9/10; G01C 9/12; G01C 9/14; G01C
9/16; G01C 9/18; G01C 9/20; G01C
9/22; G01C 9/24; G01C 9/26; G01C
9/28; G01C 9/30; G01C 9/32; G01C
9/34; G01C 9/36; G01C 2009/005; G01C
2009/062; G01C 2009/064; G01C
2009/066; G01C 2009/068; G01C
2009/102; G01C 2009/105; G01C
2009/107; G01C 2009/182; G01C
2009/185; G01C 2009/187
See application file for complete search history.

4,593,475 A 6/1986 Mayes
4,829,676 A 5/1989 Waldron
D301,553 S 6/1989 Makofsky et al.
4,876,798 A 10/1989 Zimmerman
D320,360 S 10/1991 Kennedy
D332,226 S 1/1993 Hutchins et al.
D355,134 S 2/1995 Kennedy
D412,857 S 8/1999 Howard et al.
D415,436 S 10/1999 Martone
D469,370 S 1/2003 Gruetzmacher et al.
D472,168 S 3/2003 Levinson
6,568,095 B2 5/2003 Snyder
6,782,628 B2 8/2004 Liao
D503,635 S 4/2005 Kallabis
D507,194 S 7/2005 Budrow et al.
D513,198 S 12/2005 Levinson
D519,863 S 5/2006 Kim
D521,882 S 5/2006 Kim
7,086,166 B2 8/2006 Helda et al.
7,152,335 B2 12/2006 Nichols
D582,302 S 12/2008 Johnson et al.
7,472,487 B2 1/2009 Tran et al.
D597,872 S 8/2009 Gofer

(Continued)

Primary Examiner — Antoine Duval Davis
(74) *Attorney, Agent, or Firm* — Boyle Fredrickson S.C.

(57) **CLAIM**

The ornamental design of a torpedo level, as shown and described.

DESCRIPTION

FIG. 1 is an isometric view of a torpedo level incorporating our new design, wherein the portions illustrated in phantom form no part of the claimed design;
FIG. 2 is a front elevation view thereof;
FIG. 3 is a rear elevation view thereof;
FIG. 4 is a right side elevation view thereof;
FIG. 5 is a left side elevation view thereof;
FIG. 6 is a top plan view thereof; and,
FIG. 7 is a bottom plan view thereof.

1 Claim, 6 Drawing Sheets

(56) **References Cited**
U.S. PATENT DOCUMENTS
D224,663 S 8/1972 de Jong
D280,185 S 8/1985 Wright

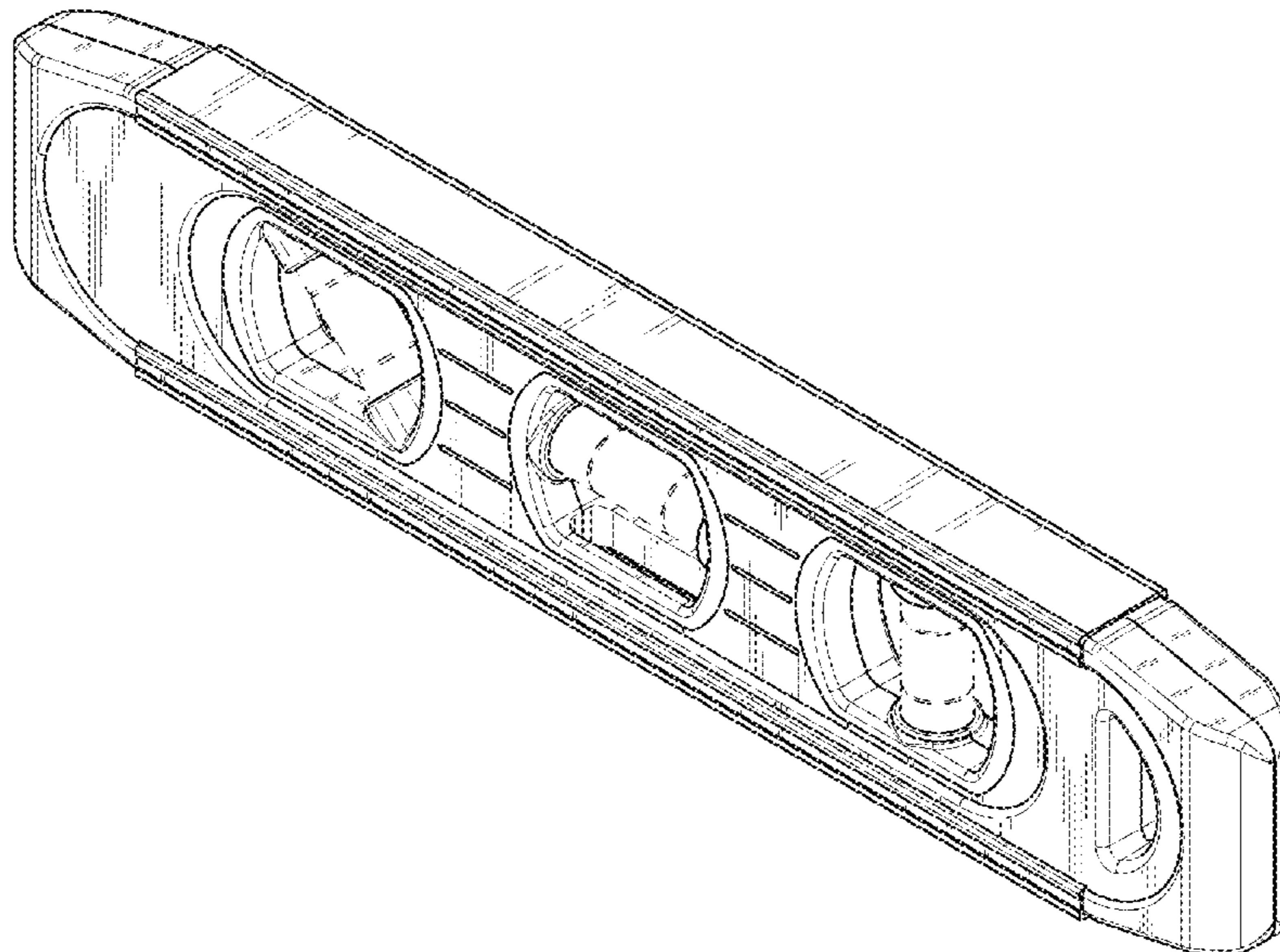

(56)

References Cited

U.S. PATENT DOCUMENTS

D597,873	S	8/2009	Gofer	
D625,630	S	10/2010	Levinson	
D628,914	S	12/2010	Kim et al.	
7,946,045	B2	5/2011	Allemand	
D644,946	S	9/2011	Silberberg	
D644,947	S	9/2011	Silberberg	
8,061,051	B2	11/2011	Allemand	
D694,659	S	12/2013	Yong et al.	
D704,577	S	5/2014	Levinson	
D723,955	S	3/2015	Wojciechowski et al.	
D723,956	S	3/2015	Johnson et al.	
D729,645	S	5/2015	Wojciechowski et al.	
D751,428	S	3/2016	Johnson et al.	
D777,589	S	1/2017	Wojciechowski et al.	
D898,594	S	*	10/2020	Wojciechowski D10/69
2005/0252016	A1	11/2005	Helda et al.	
2008/0282562	A1	11/2008	Allemand	

* cited by examiner

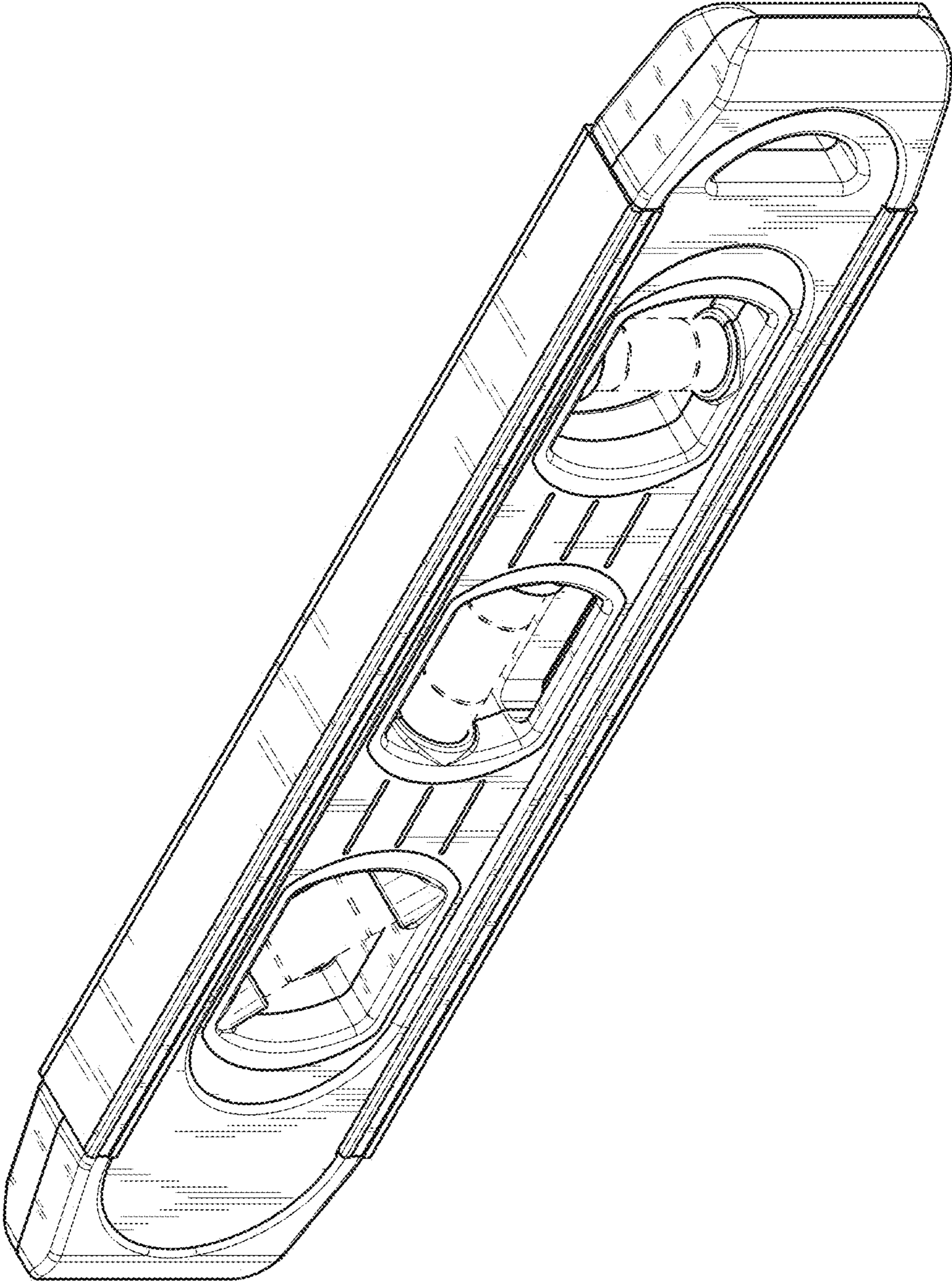

FIG. 1

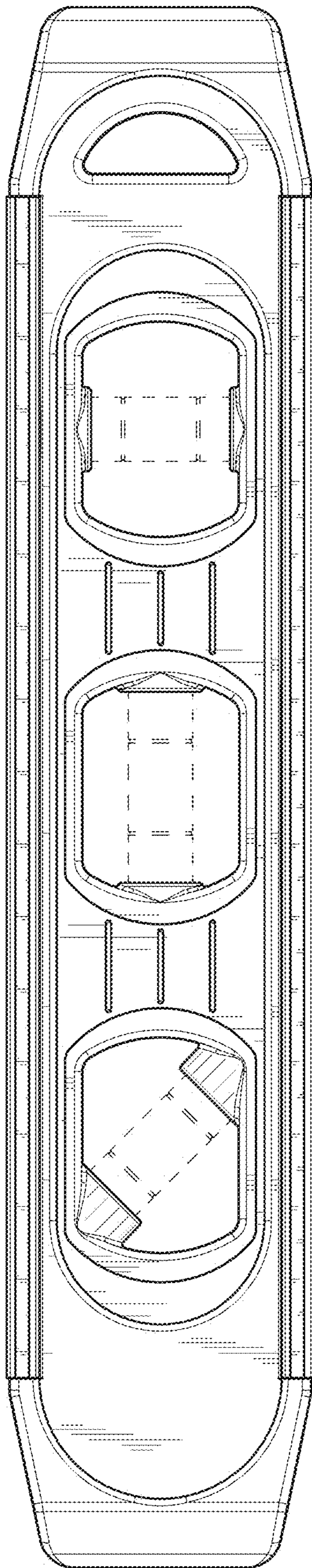

FIG. 2

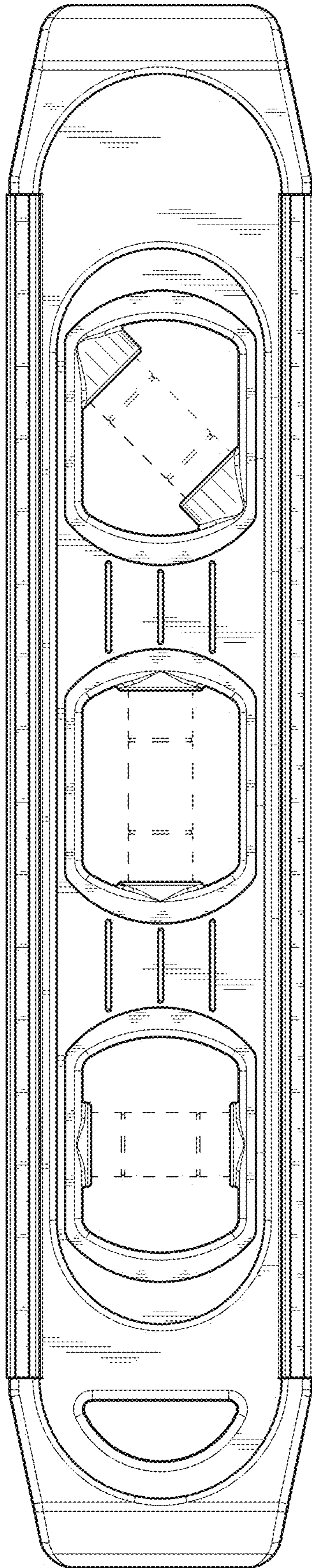

FIG. 3

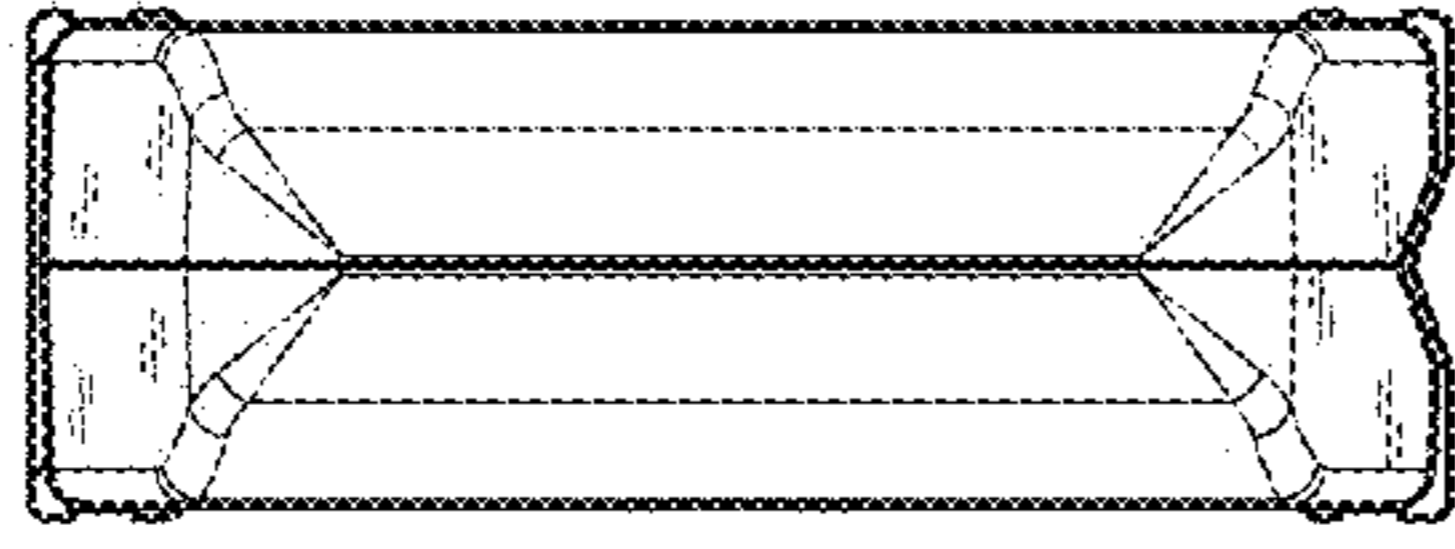

FIG. 5

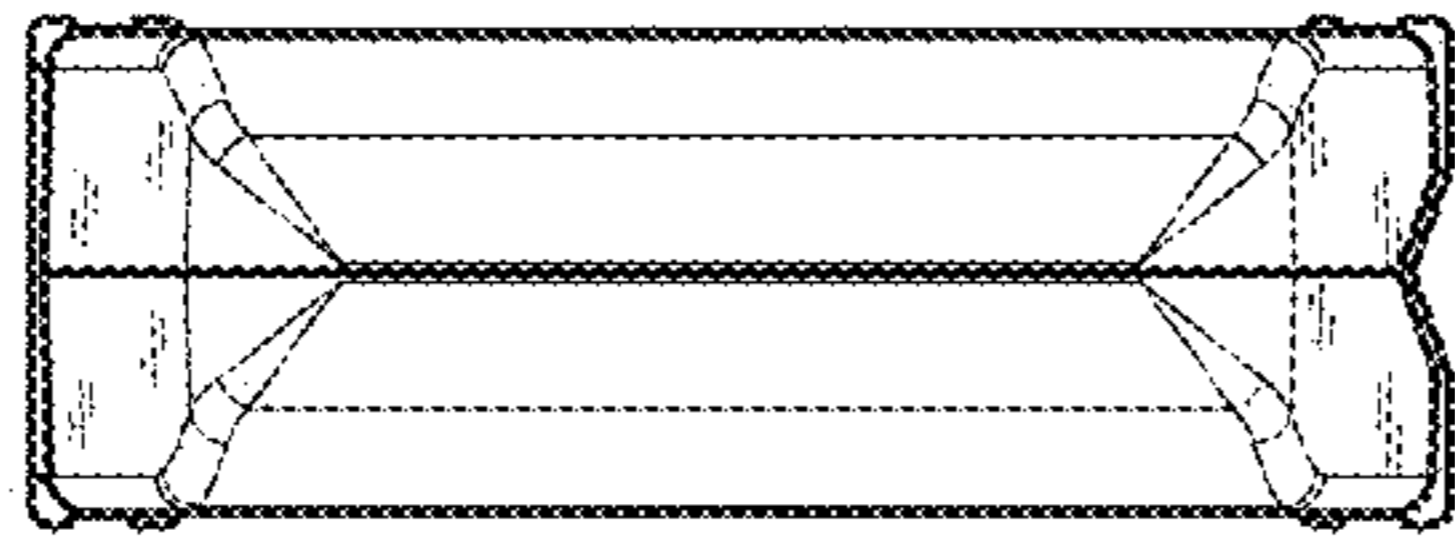

FIG. 4

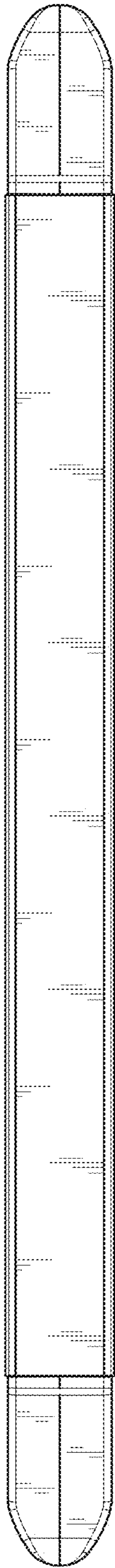

FIG. 6

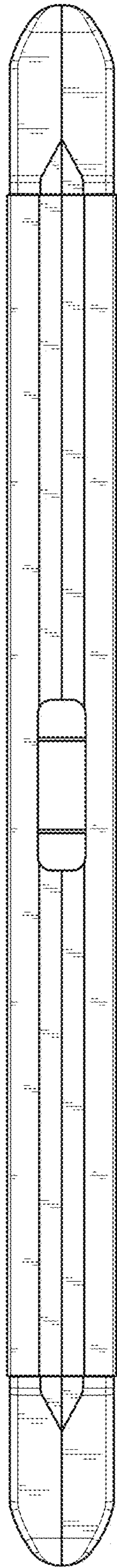

FIG. 7