



US00D936410S

(12) **United States Design Patent** (10) **Patent No.:** **US D936,410 S**
Donke et al. (45) **Date of Patent:** **** Nov. 23, 2021**

(54) **COOKING BRICK**

(71) Applicant: **BRICKNIC**, Eindhoven (NL)

(72) Inventors: **Timm Donke**, Eindhoven (NL); **Leif Czakai**, Eindhoven (NL)

(73) Assignee: **BRICKNIC**, Eindhoven (NL)

(**) Term: **15 Years**

(21) Appl. No.: **29/696,984**

(22) Filed: **Jul. 3, 2019**

(51) **LOC (13) Cl.** **07-02**

(52) **U.S. Cl.**
USPC **D7/354**

(58) **Field of Classification Search**

USPC D7/323, 339, 340, 341, 342, 343, 344,
D7/345, 346, 347, 348, 349, 351, 352,
D7/354, 356, 359, 360, 361, 388, 390,
D7/402, 403, 404, 405, 406, 407, 408,
D7/409; D9/636, 640, 501, 503, 504,
D9/424

CPC A21B 1/00; A21B 1/52; A21B 5/00; A21B
5/023; A21B 3/13; A21B 3/131; A21B
3/132; A21B 3/133; A21B 3/138; A21B
3/15; A47J 37/00; A47J 37/04; A47J
37/06; A47J 37/0623; A47J 37/0611;
A47J 37/067; A47J 37/0605; A47J
37/0629; A47J 37/0676; A47J 27/60;
A47J 27/62; A47J 36/022; A47J 36/025;
A47J 36/027; A47G 19/02; A47G 19/027;
A47G 19/22; F24C 1/00; F24C 3/00;
F24C 3/002; F24C 3/008; F24C 5/00;
F24C 7/00; F24C 7/002; F24C

(Continued)

(56) **References Cited**

U.S. PATENT DOCUMENTS

D263,561 S * 3/1982 Wong D3/295
4,530,440 A * 7/1985 Leong A47J 36/022
220/201

(Continued)

OTHER PUBLICATIONS

Romertopf Individual Cooking Brick, announced Apr. 11, 2020 [online], retrieved Sep. 14, 2020, retrieved from internet, https://www.amazon.com/Romertopf-99800M-Individual-Cooking-Terra-cotta/dp/B07WVN5HKQ/ref=asc_df_B07WVN5HKQ/?tag=hyprod-20&linkCode=df0&hvadid=416903612782&hvpos=&hvnetw=g&hvrnd=7781022417444.*

(Continued)

Primary Examiner — Dana K Weiland

Assistant Examiner — Messina L Smith

(74) *Attorney, Agent, or Firm* — Graeser Associates International Inc; Dvorah Graeser

(57) **CLAIM**

We claim the design for a cooking brick, as shown and described.

DESCRIPTION

FIG. 1 is a perspective view of a cooking brick showing the new design, shown in a closed configuration.

FIG. 2 is another perspective view thereof.

FIG. 3 is a perspective view of the cooking brick shown in an open configuration.

FIG. 4 is a top perspective view thereof.

FIG. 5 is a top perspective view of the cooking brick shown in the open configuration, with the top and bottom portions shown separately to show aspects of the design that are not visible when combined.

FIG. 6 is a top plan view of the cooking brick shown in the closed configuration.

FIG. 7 is a top plan view of the cooking brick shown in the open configuration, with the top and bottom portions shown separately to show aspects of the design that are not visible when combined; and,

FIG. 8 is a perspective view of the cooking brick shown in the open configuration, with the top portion set inside the bottom portion.

The broken lines in the drawing depict portions of the cooking brick that are not part of the claimed design.

1 Claim, 8 Drawing Sheets

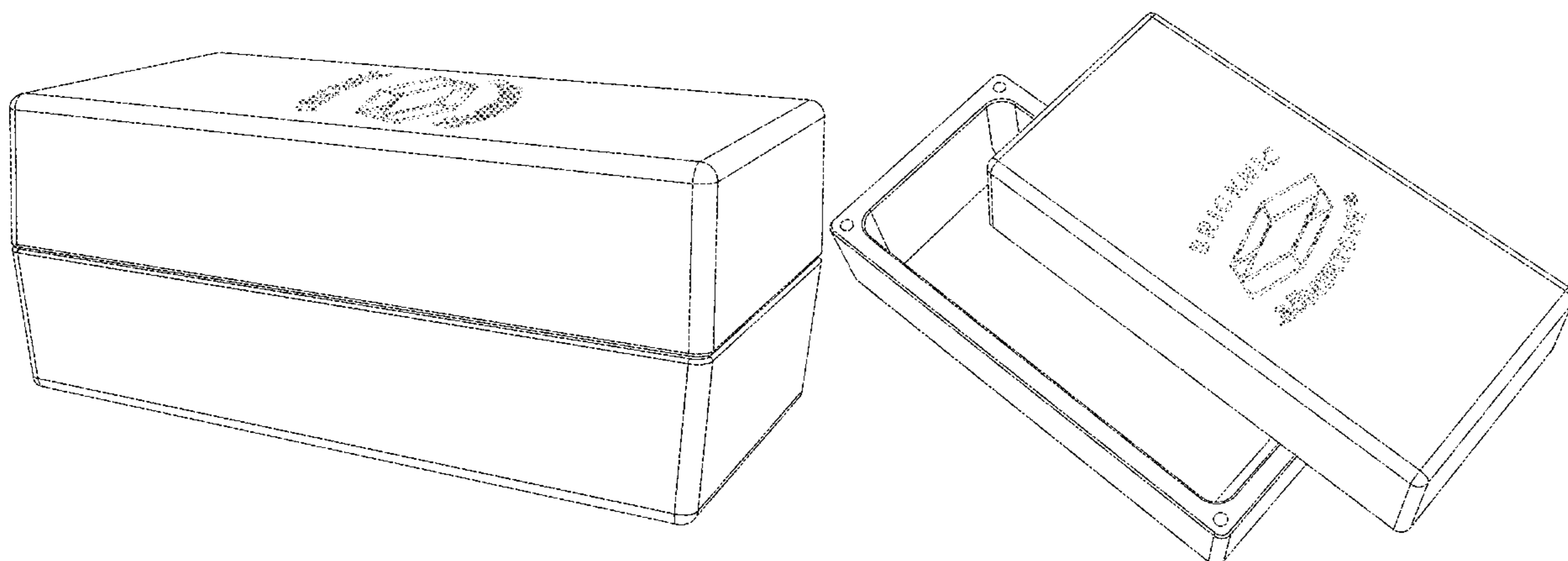

(58) **Field of Classification Search**
 CPC 7/043; F24C 7/062; F24C 11/00; F24C
 15/02; F24C 15/04; F24C 15/10
 See application file for complete search history.

(56) **References Cited**

U.S. PATENT DOCUMENTS

4,749,097 A * 6/1988 Rosman A21B 3/13
 220/4.21
 RE33,447 E * 11/1990 Rosman A21B 3/13
 220/4.21
 5,876,811 A * 3/1999 Blackwell A47J 36/022
 220/500
 6,171,990 B1 * 1/2001 Petschauer B32B 18/00
 428/702
 D496,585 S * 9/2004 McBride D3/294
 7,357,273 B1 * 4/2008 Lutz A47J 36/027
 220/366.1
 D585,733 S * 2/2009 Feibelman D9/418
 D587,567 S * 3/2009 Peyser D9/424
 D694,102 S * 11/2013 Bellamah D9/424
 8,887,943 B1 * 11/2014 Miller B65D 1/34
 220/573.1
 D741,703 S * 10/2015 Janson D9/424
 D746,671 S * 1/2016 Fohner D9/414
 9,510,699 B1 * 12/2016 Miller A47G 23/04

D791,767 S * 7/2017 Ali D14/358
 10,350,449 B2 * 7/2019 Abrahams A63B 23/0458
 D871,674 S * 12/2019 Tan D28/57
 D891,879 S * 8/2020 Adams, Jr. D7/629
 2004/0192523 A1 * 9/2004 Wu A63B 21/00047
 482/148
 2005/0271783 A1 * 12/2005 Digges, III A47J 37/0694
 426/523
 2009/0061128 A1 * 3/2009 Liu A21B 3/138
 428/34.4
 2009/0101025 A1 * 4/2009 Penson A21B 3/13
 99/426
 2015/0258363 A1 * 9/2015 Kampinski A63B 21/4037
 482/139
 2016/0145153 A1 * 5/2016 Hwang C04B 28/08
 106/707

OTHER PUBLICATIONS

Romertopf 99800 Bricknic Individual Grilling Dish, announced ©
 2020 [online], retrieved Sep. 14, 2020, retrieved from internet,
https://www.walmart.com/ip/Romertopf-99800-Bricknic-Individual-Grilling-Dish/784463549?wmlspartner=wlp&selectedSellerId=1148&&adid=2222222227346002154&w10=&w11=g&w12=c&w13=430112645.*

* cited by examiner

FIGURE 1

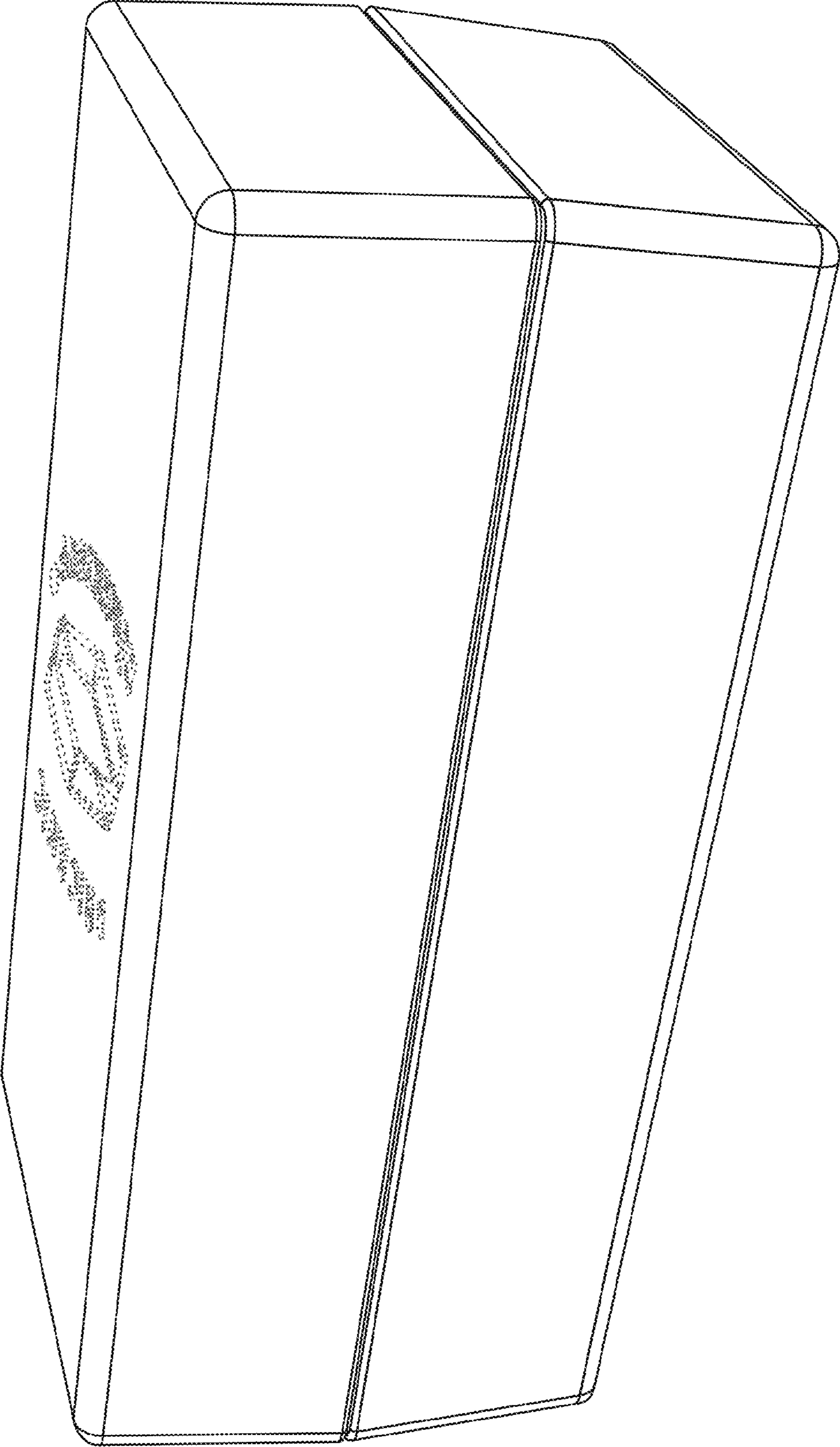

FIGURE 2

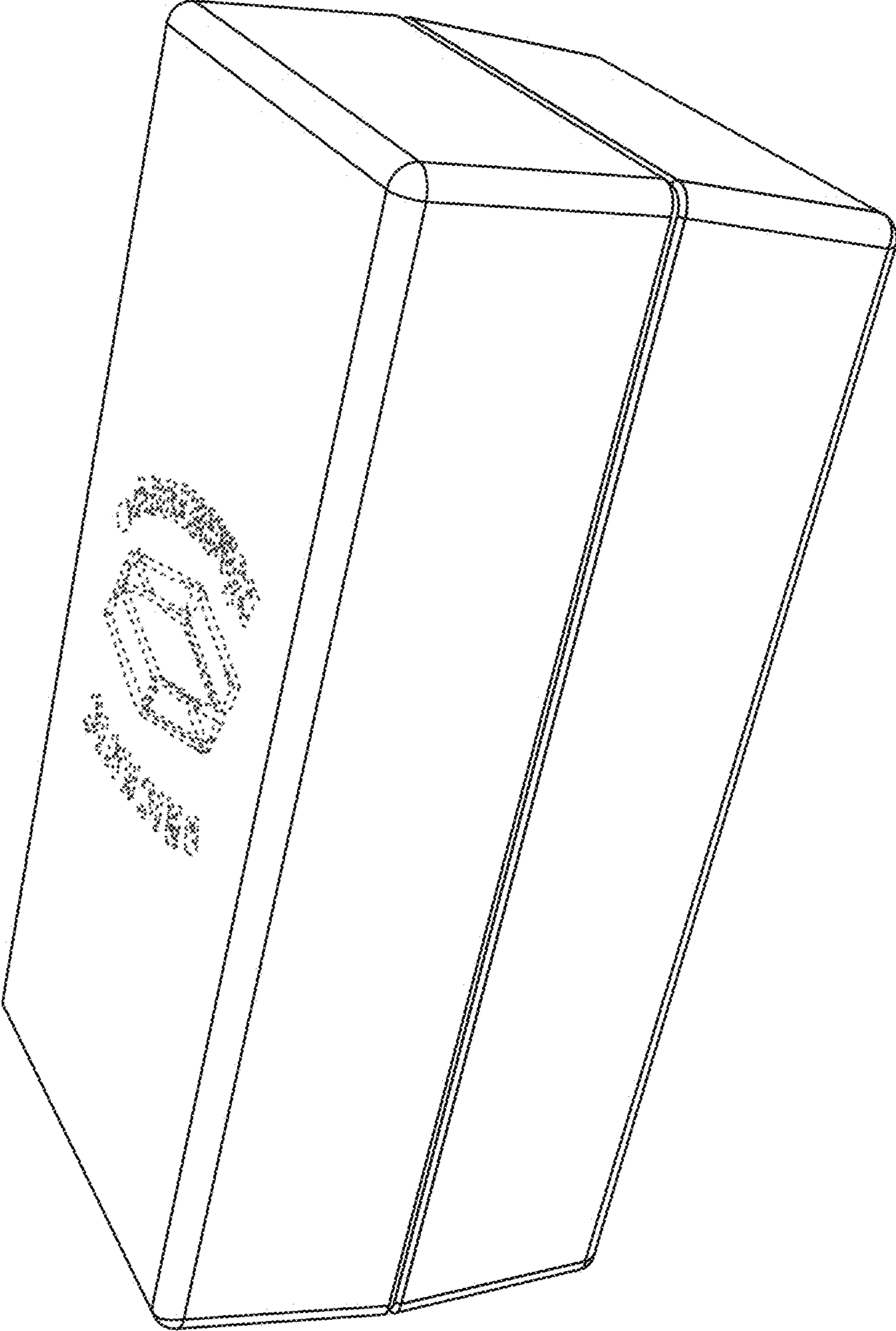

FIGURE 3

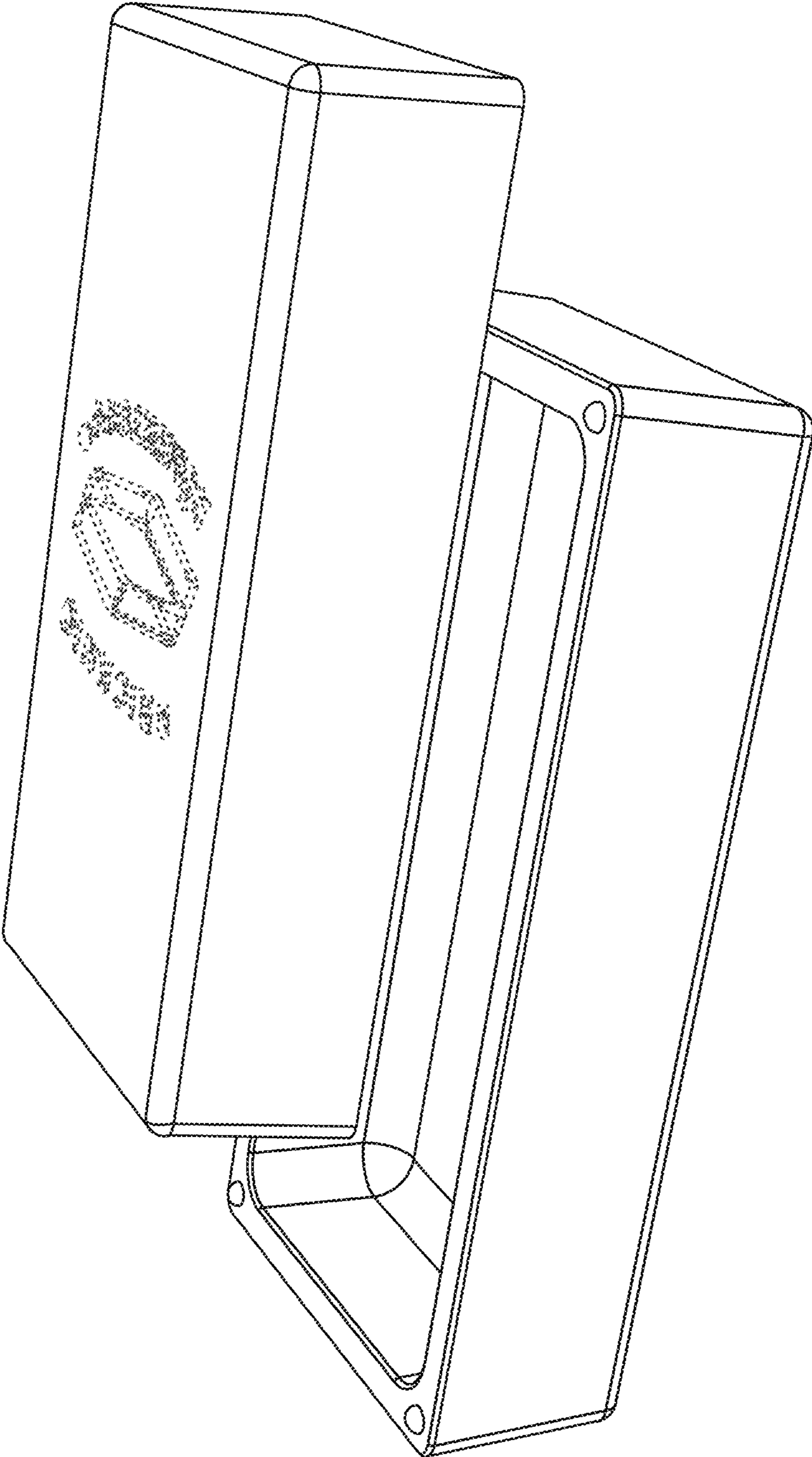

FIGURE 4

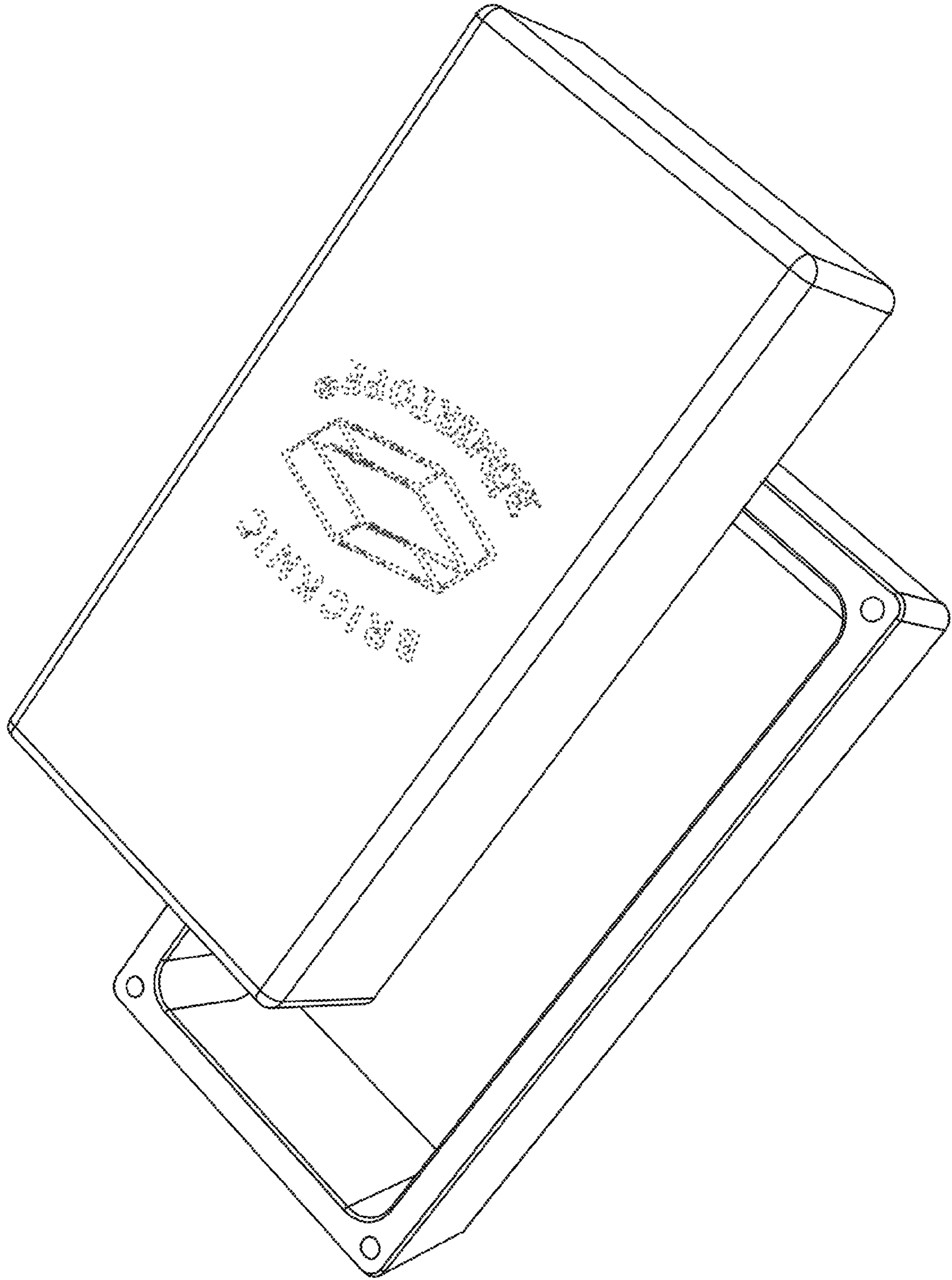

FIGURE 5

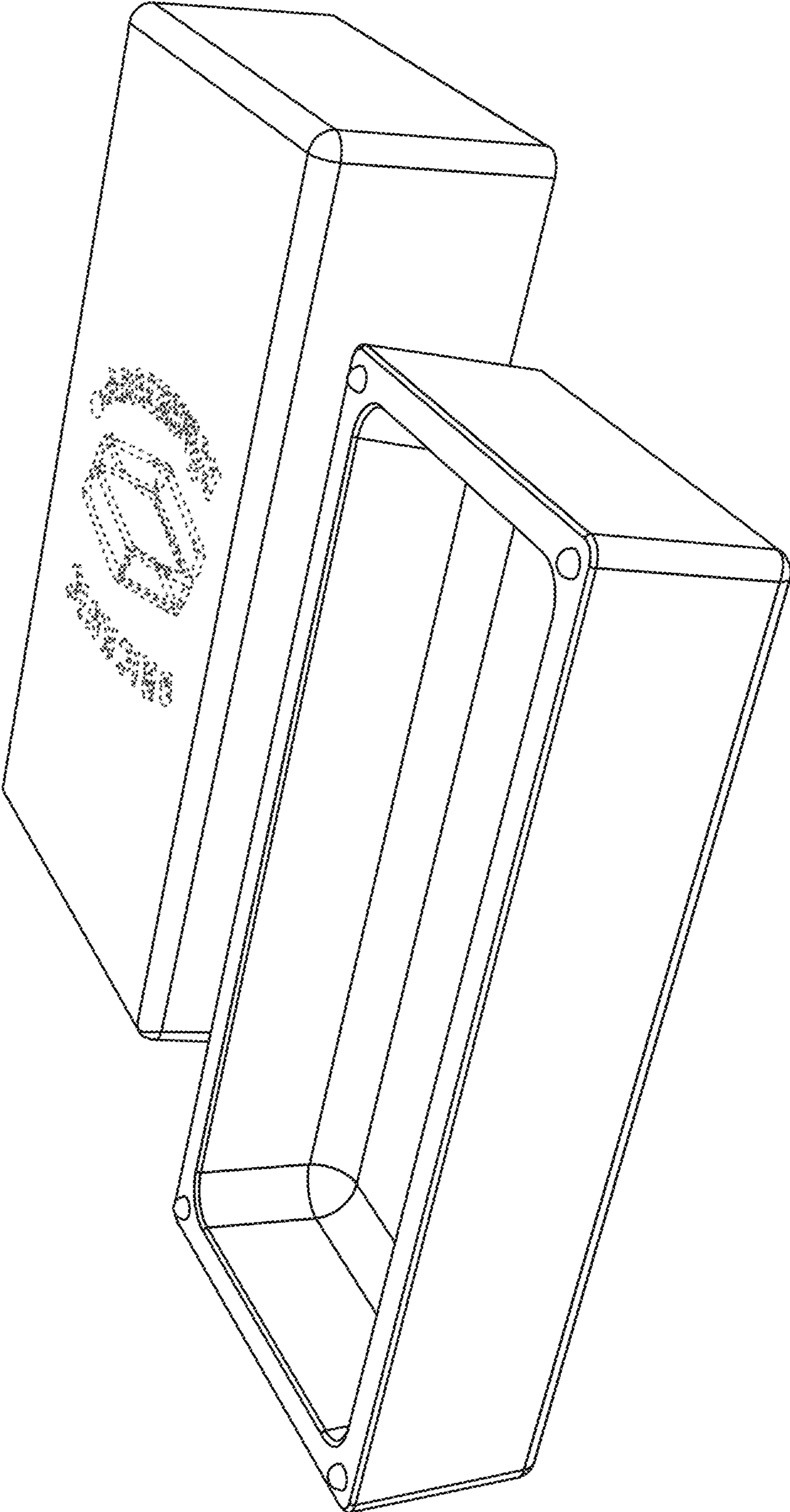

FIGURE 6

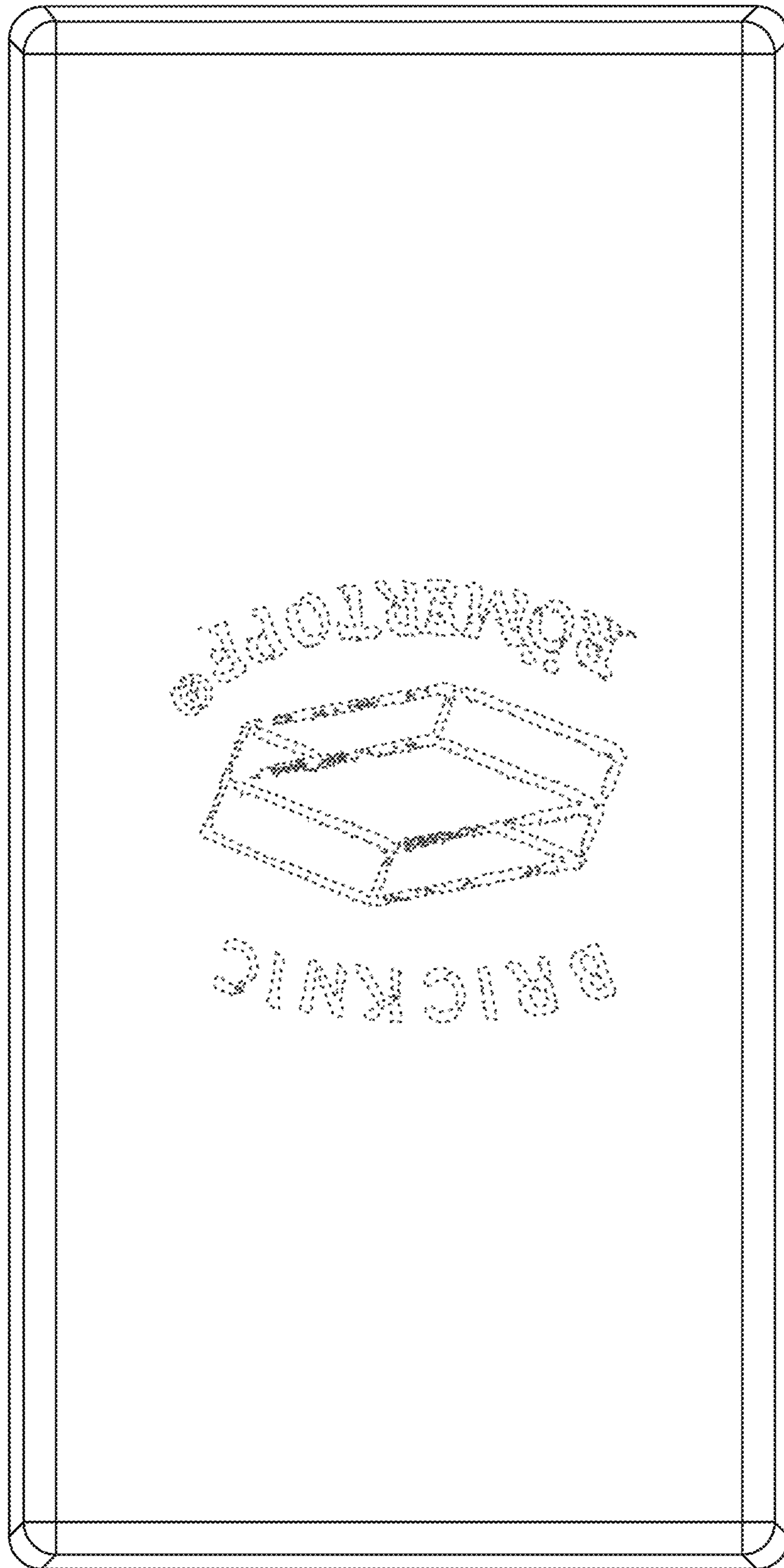

FIGURE 7

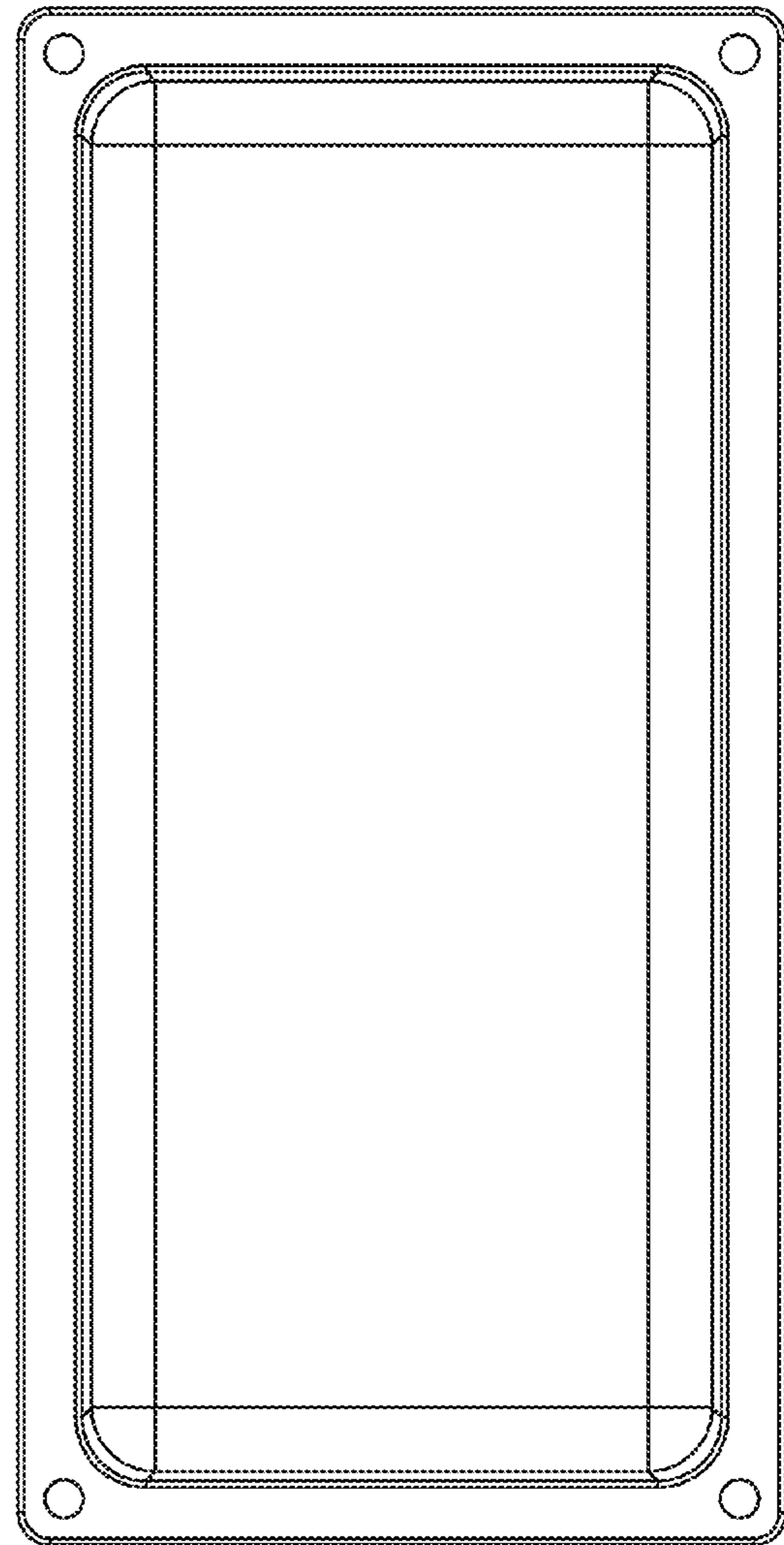
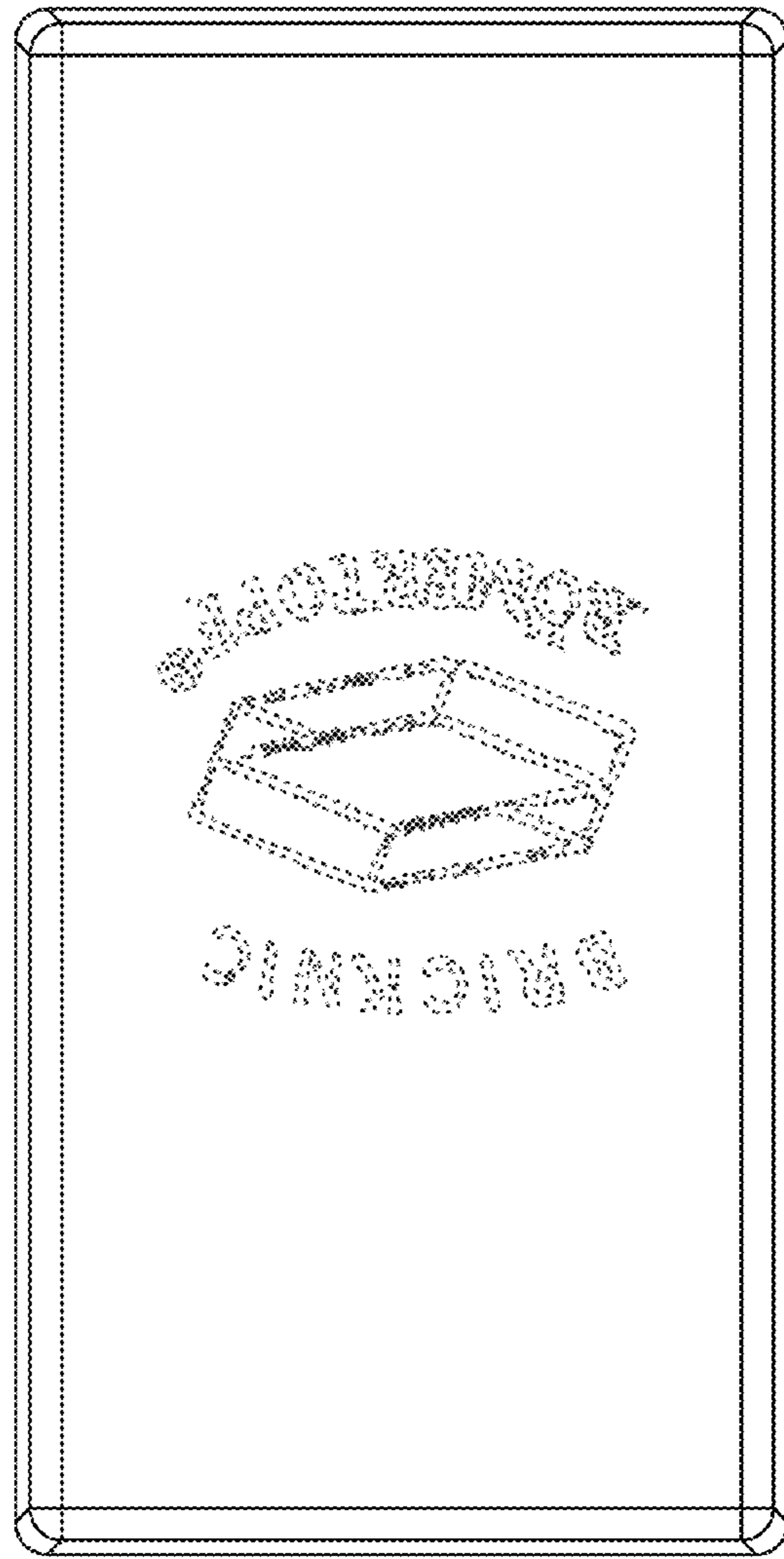

FIGURE 8

