



US00D936319S

(12) **United States Design Patent**
Khan

(10) **Patent No.:** **US D936,319 S**

(45) **Date of Patent:** **** Nov. 16, 2021**

- (54) **FOLDABLE DRYING RACK**
- (71) Applicant: **Ruvati USA, Inc.**, Round Rock, TX (US)
- (72) Inventor: **Maruf Khan**, Round Rock, TX (US)
- (73) Assignee: **Ruvati USA, Inc.**, Round Rock, TX (US)
- (**) Term: **15 Years**
- (21) Appl. No.: **29/726,573**
- (22) Filed: **Mar. 4, 2020**
- (51) **LOC (13) Cl.** **07-05**
- (52) **U.S. Cl.**
USPC **D32/57; D32/55**
- (58) **Field of Classification Search**
USPC D32/55, 276, 3; D6/510, 525; D30/133;
211/41.5, 41.4, 41.3, 41.8; 361/679.4;
312/311, 333, 334.4; D7/354, 629
CPC .. A47L 15/505; A47L 15/503; A47L 15/0013;
A47L 19/02; A47L 19/04; A47J 47/20
See application file for complete search history.

(56) **References Cited**

U.S. PATENT DOCUMENTS

- 1,667,657 A * 4/1928 Dobert A47B 5/04
211/99
- D200,728 S * 3/1965 Spielman D32/58
- D238,410 S * 1/1976 Weick D32/58
- D391,719 S * 3/1998 Anderson D32/58

- 6,726,036 B2 * 4/2004 Koellner D06F 57/12
211/104
- D641,189 S * 7/2011 Klotz D6/705
- D669,685 S * 10/2012 Legreca D3/304
- D752,951 S * 4/2016 Bomatter D8/349
- D806,973 S * 1/2018 Karr D32/58
- D839,643 S * 2/2019 De Jesus D6/681.3

* cited by examiner

Primary Examiner — Austin Murphy

(74) *Attorney, Agent, or Firm* — Craige Thompson;
Thompson Patent Law; Timothy D. Snowden

(57) **CLAIM**

The ornamental design for the foldable drying rack, as shown and described.

DESCRIPTION

FIG. 1 is a front, top, and right perspective view of a foldable drying rack showing the new design;
 FIG. 2 is a front elevation view of the foldable drying rack of FIG. 1;
 FIG. 3 is a back side elevation view of the foldable drying rack of FIG. 1;
 FIG. 4 is a left side elevation view of the foldable drying rack of FIG. 1; and
 FIG. 5 is a right side elevation view of the foldable drying rack of FIG. 1; and,
 FIG. 6 is a top plan view of the foldable drying rack of FIG. 1, the opposite side being a mirror image thereof.
 The broken lines are for illustrative purposes only and form no part of the claimed design.

1 Claim, 6 Drawing Sheets

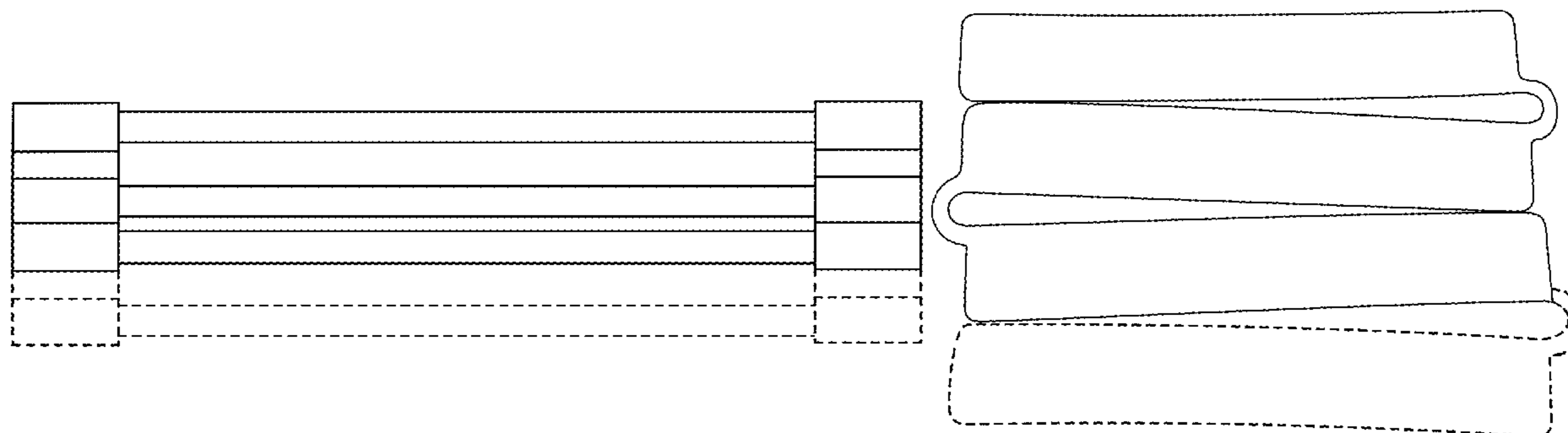

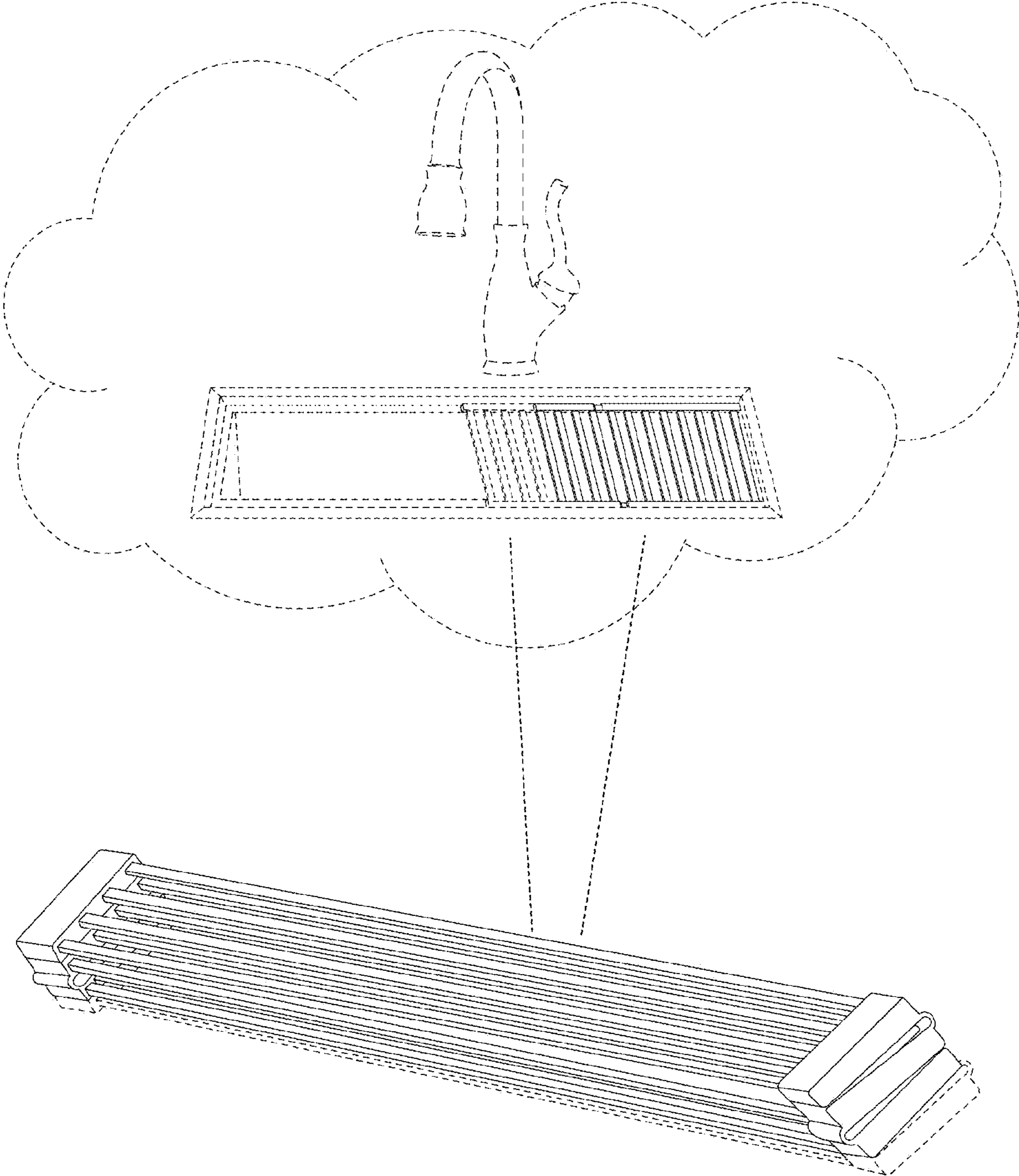

Fig. 1

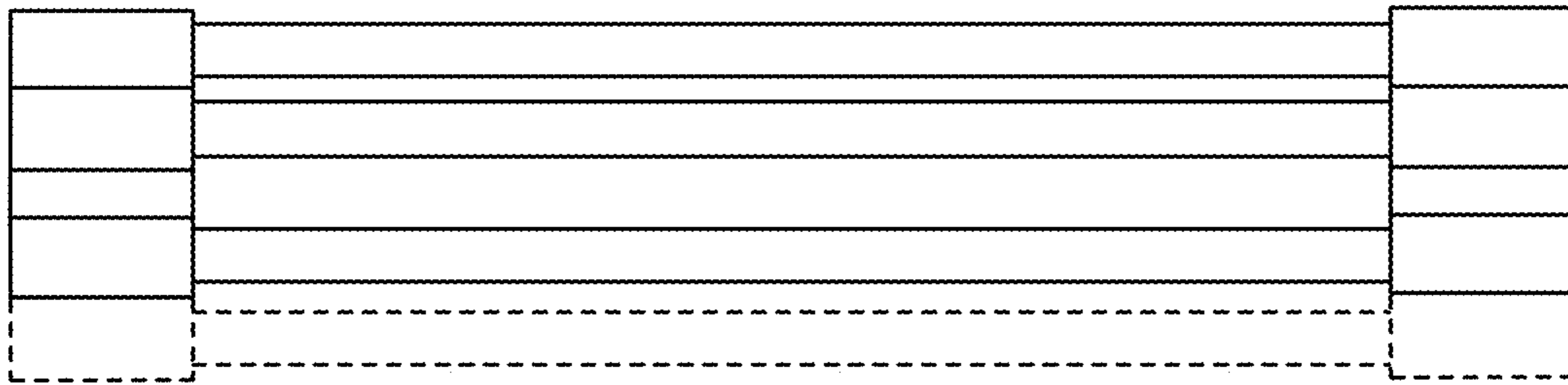

FIG. 2

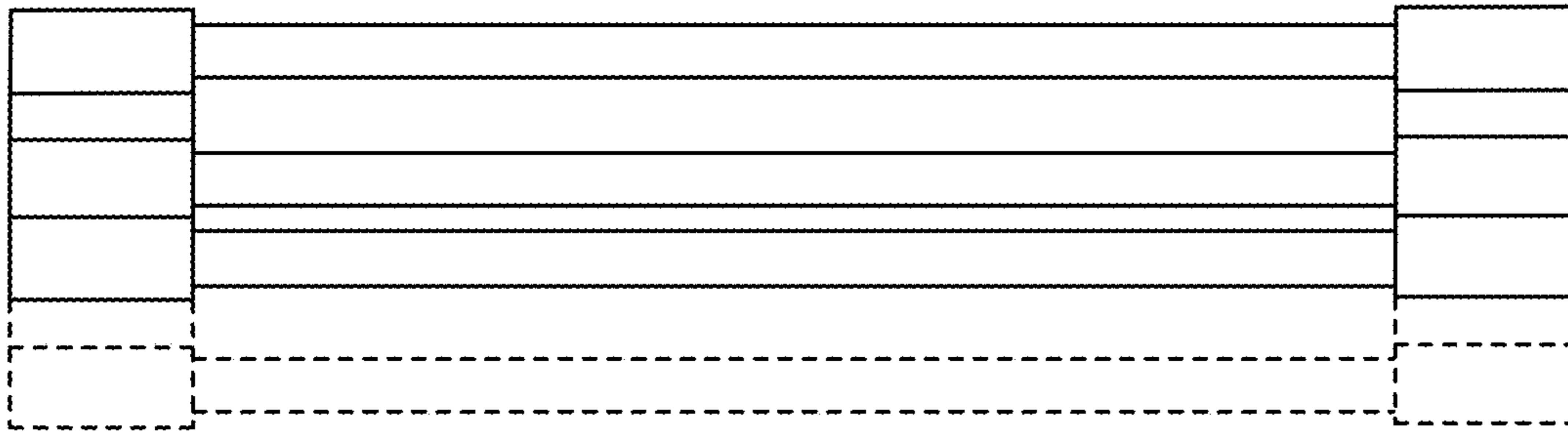

FIG. 3

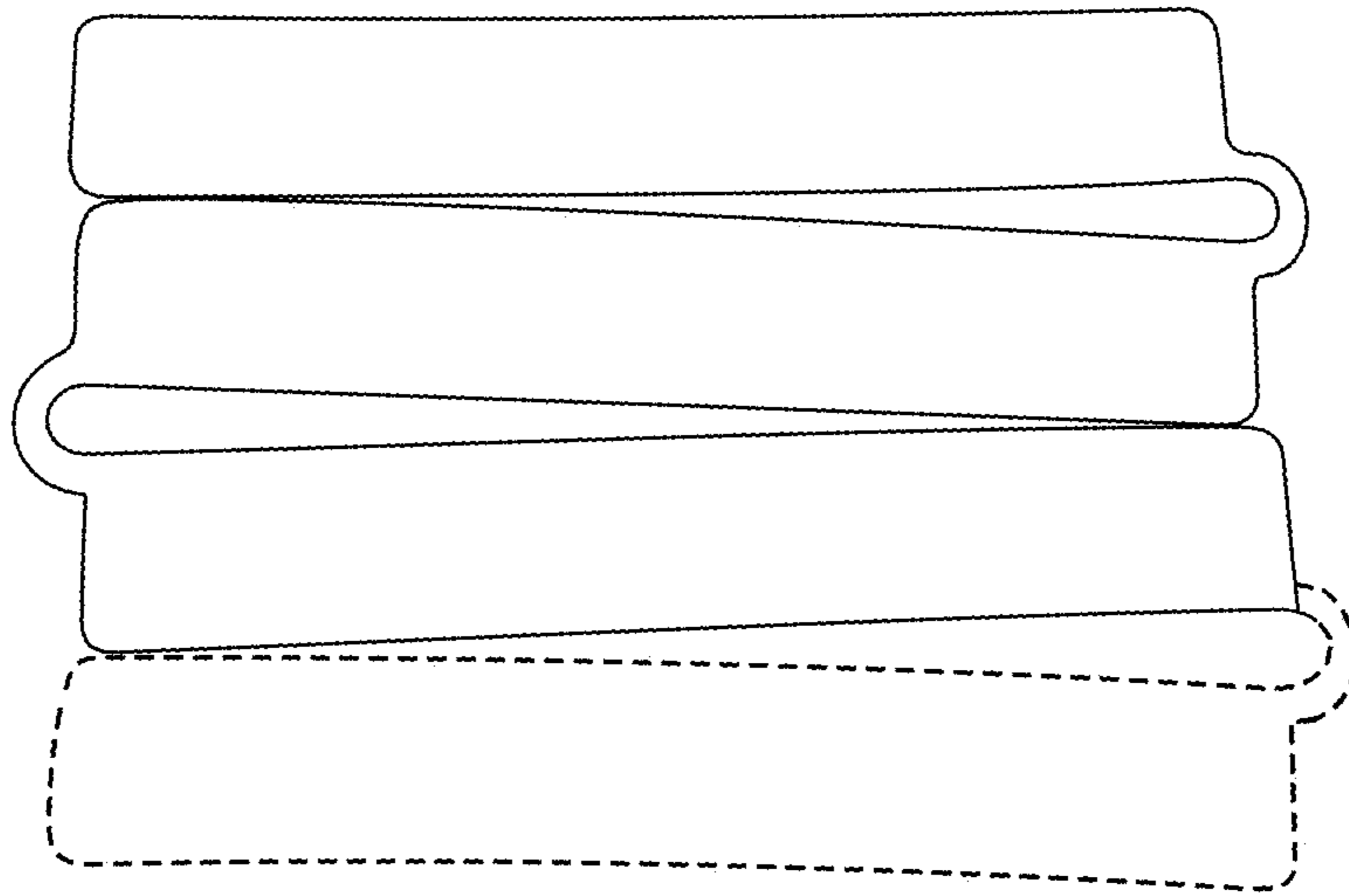

FIG. 4

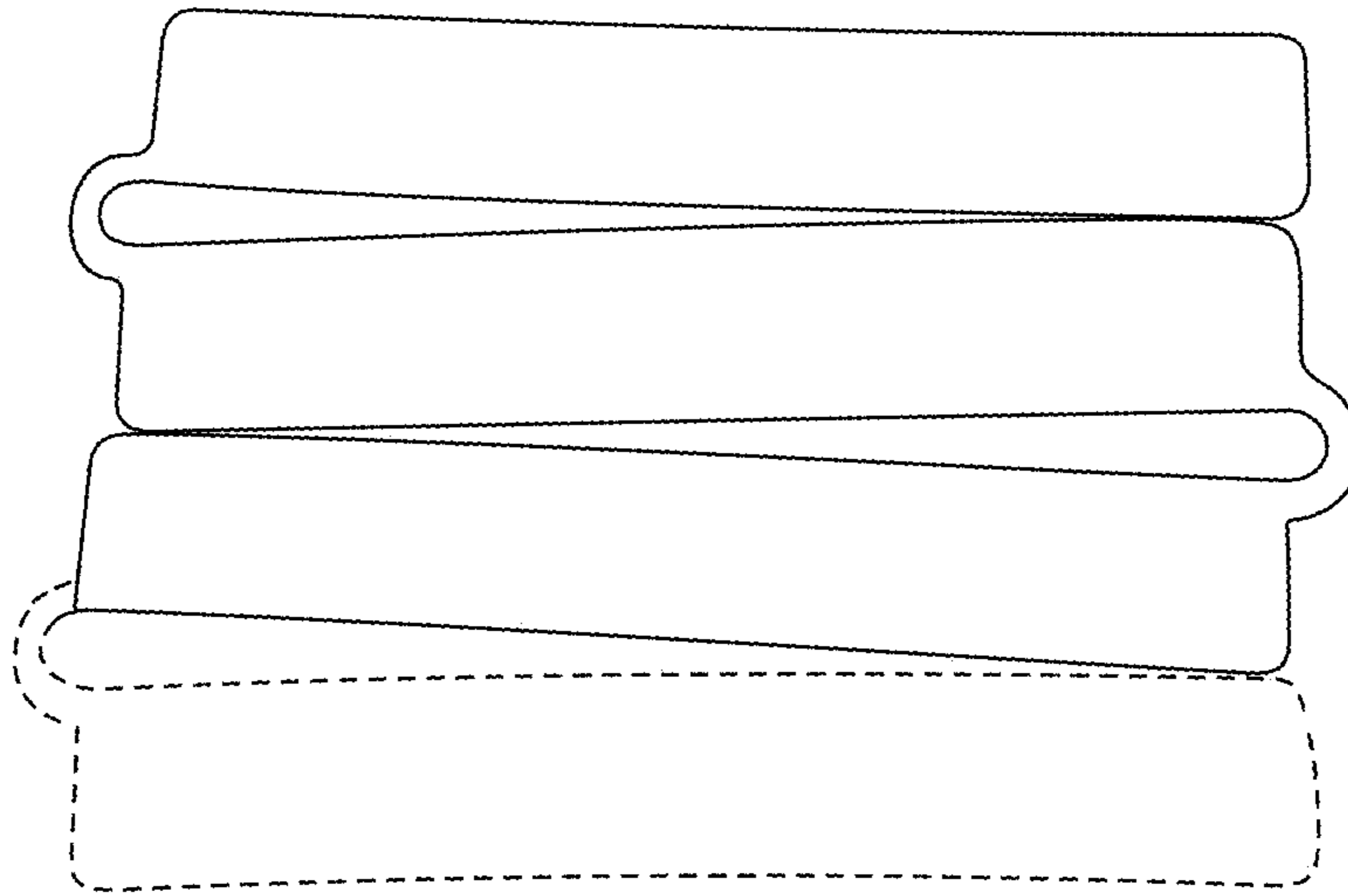

FIG. 5

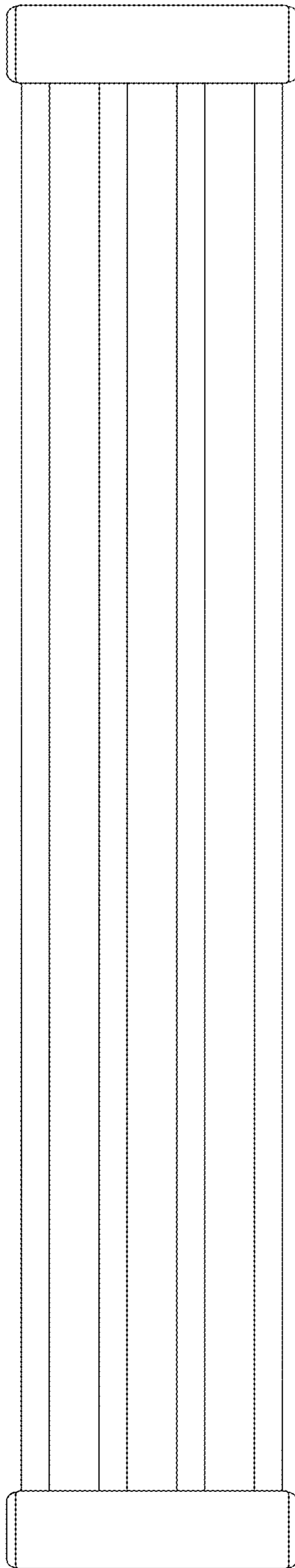

FIG. 6