



US00D936309S

(12) **United States Design Patent**  
**Zou**

(10) **Patent No.:** **US D936,309 S**

(45) **Date of Patent:** **\*\* Nov. 16, 2021**

(54) **VACUUM CLEANER**

(71) Applicant: **FINE DRAGON TECHNOLOGY LIMITED**, Guangdong (CN)

(72) Inventor: **Zhenren Zou**, Guangdong (CN)

(73) Assignee: **FINE DRAGON TECHNOLOGY LIMITED**, Shenzhen (CN)

(\*\*) Term: **15 Years**

(21) Appl. No.: **29/740,130**

(22) Filed: **Jul. 1, 2020**

(51) **LOC (13) Cl.** ..... **15-05**

(52) **U.S. Cl.**  
USPC ..... **D32/18**

(58) **Field of Classification Search**  
USPC ..... D32/17-25, 31-34  
CPC ..... A47L 7/00; A47L 9/02; A47L 5/24; A47L 5/26; A47L 5/28; A47L 9/102; A47L 9/1608; A47L 9/1683; A47L 9/2857; A47L 5/30; A47L 9/00; A47L 9/04; A47L 9/0461; A47L 9/06; A47L 9/0488; A47L 11/00; A47L 11/20; A47L 11/32; A47L 11/302; A47L 11/40

See application file for complete search history.

(56) **References Cited**

**U.S. PATENT DOCUMENTS**

4,011,624	A	*	3/1977	Proett	.....	A47L 5/24	15/344
D247,341	S	*	2/1978	Pelly	.....	D32/18	
D253,452	S	*	11/1979	Tack	.....	D32/18	
D259,618	S	*	6/1981	Tack	.....	D32/18	
D302,876	S	*	8/1989	Ikeda	.....	D32/18	
D315,622	S	*	3/1991	deBlois	.....	D32/18	
D418,262	S	*	12/1999	Yuen	.....	D32/18	
D459,560	S	*	6/2002	Lau	.....	D32/18	
D480,846	S	*	10/2003	Ki	.....	D32/18	
D481,842	S	*	11/2003	Tai	.....	D32/18	

D501,065	S	*	1/2005	Ma	.....	D32/18	
D507,385	S	*	7/2005	Ma	.....	D32/18	
D510,162	S	*	9/2005	Ma	.....	D32/18	
D514,758	S	*	2/2006	Lau	.....	D32/18	
D527,501	S	*	8/2006	Tai	.....	D32/18	
D529,671	S	*	10/2006	Yung	.....	D32/18	
8,069,529	B2	*	12/2011	Groff	.....	A47L 5/24	15/344
D734,575	S	*	7/2015	Zeng	.....	D32/18	
D898,311	S	*	10/2020	Smith	.....	D32/18	
D924,502	S	*	7/2021	Xu	.....	D32/18	

**OTHER PUBLICATIONS**

Portable Or Car Wet and Dry Vacuum Cleaner (on-line), no date available. Retrieved from Internet Aug. 10, 2021, URL: [https://www.alibaba.com/product-detail/9000Pa-Hign-Suction-Power-Thau-Bissel\\_1600075488804.html](https://www.alibaba.com/product-detail/9000Pa-Hign-Suction-Power-Thau-Bissel_1600075488804.html) (2 pages).\*

\* cited by examiner

*Primary Examiner* — Kimberly Barnes

(57) **CLAIM**

The ornamental design for a vacuum cleaner, as shown and described.

**DESCRIPTION**

FIG. 1 is a top, front and left side perspective view of a vacuum cleaner showing my new design; FIG. 2 is a bottom, rear and right side perspective view thereof; FIG. 3 is a front elevational view thereof; FIG. 4 is a rear elevational view thereof; FIG. 5 is a left side view thereof; FIG. 6 is a right side view thereof; FIG. 7 is a top plan view thereof; and, FIG. 8 is a bottom plan view thereof. The broken lines in the drawings illustrate portions of the vacuum cleaner which form no part of the claimed design.

**1 Claim, 8 Drawing Sheets**

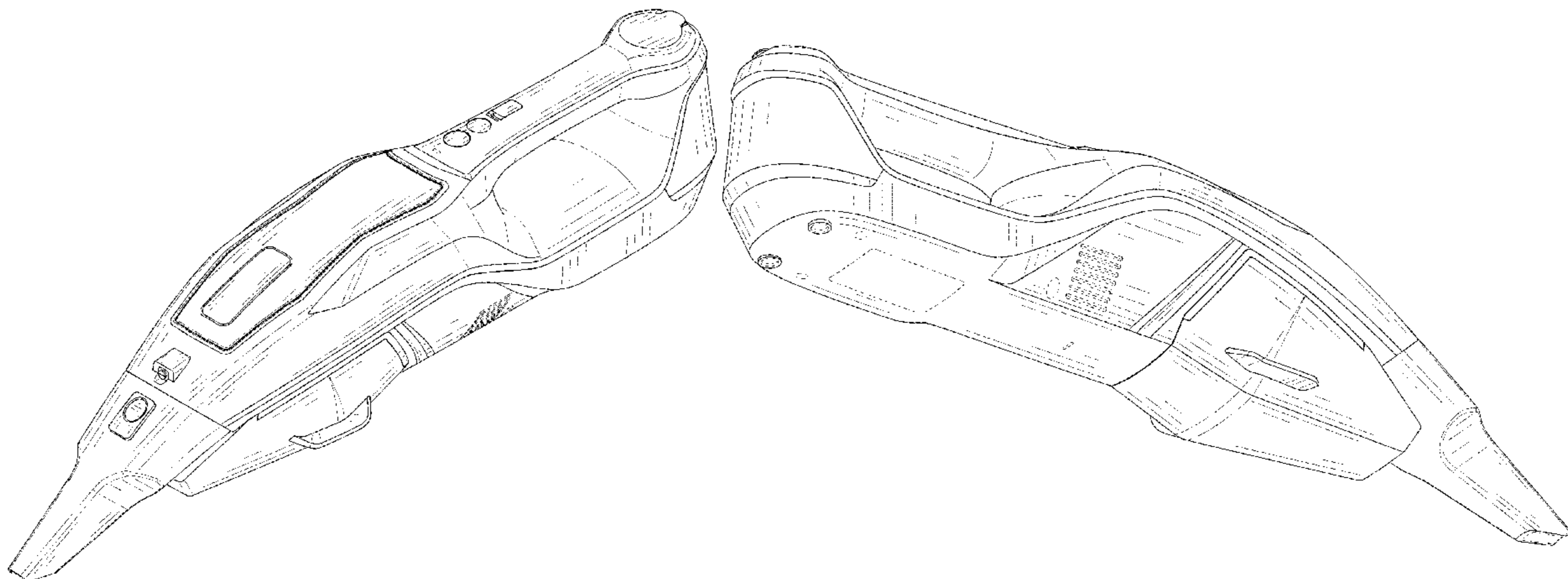

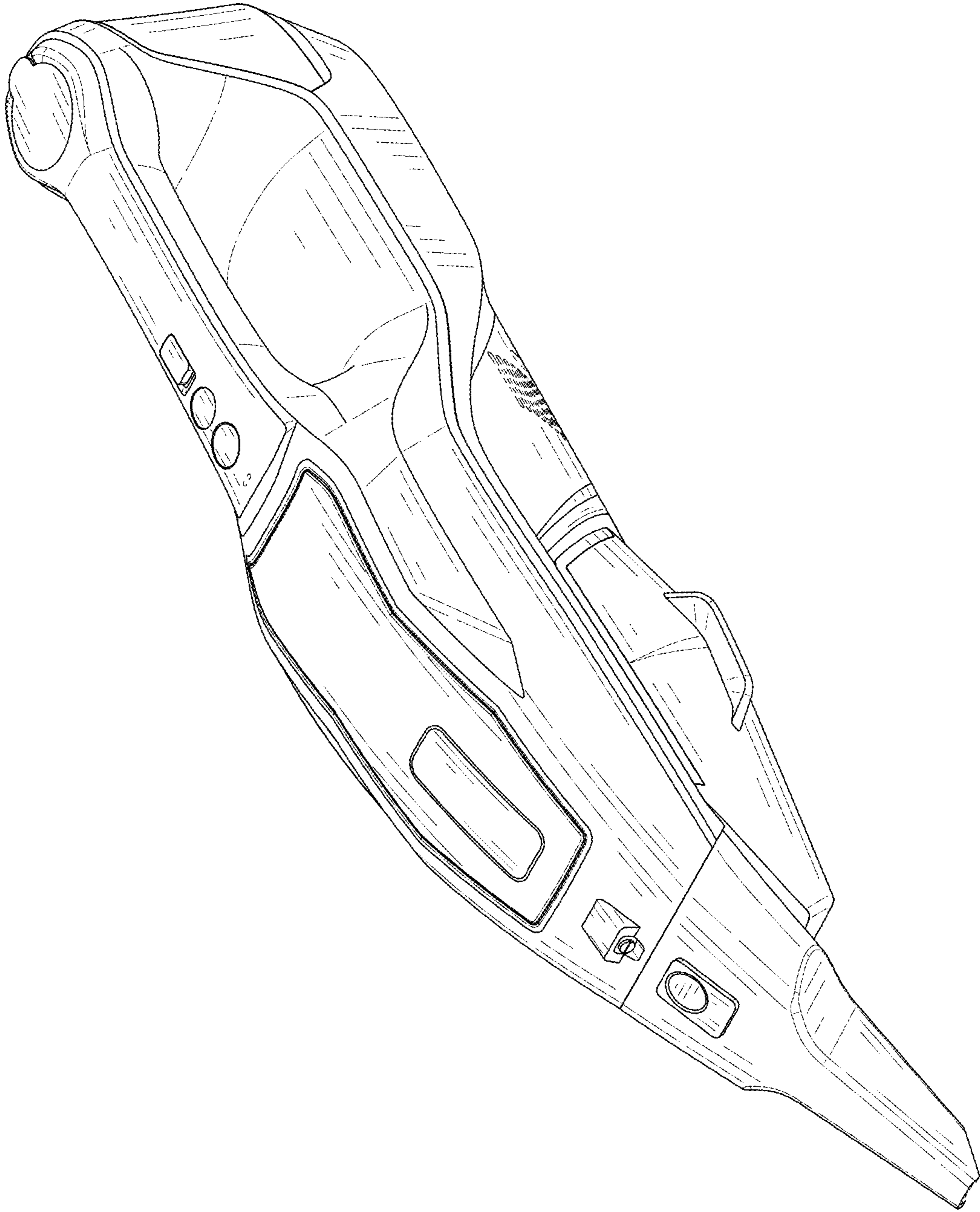

FIG. 1

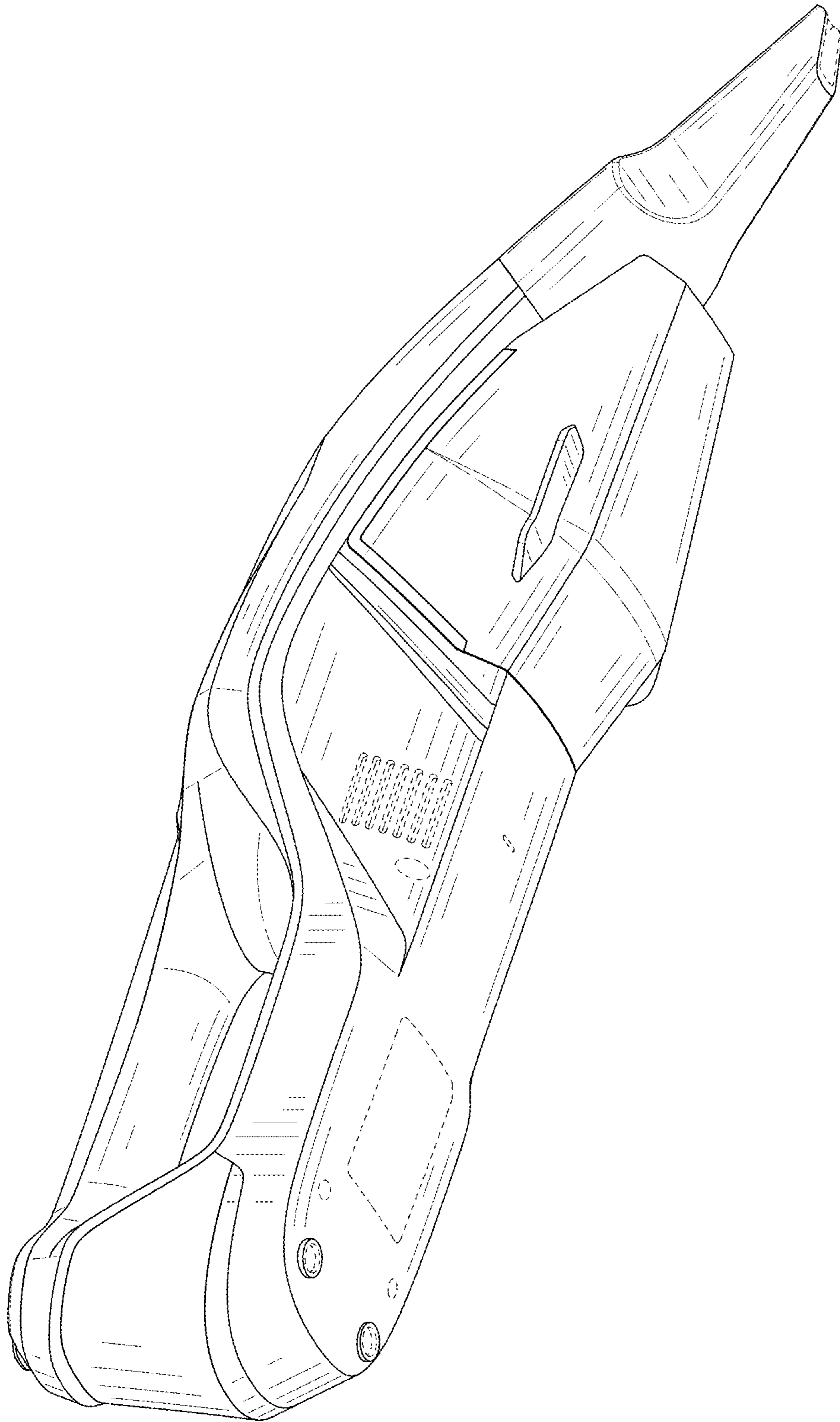

FIG. 2

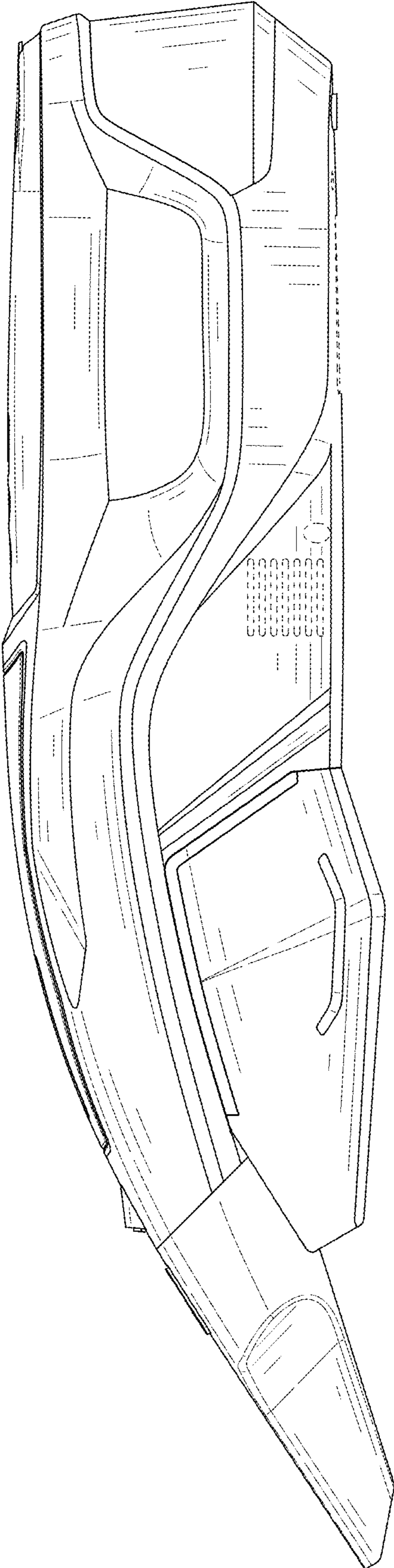

FIG. 3

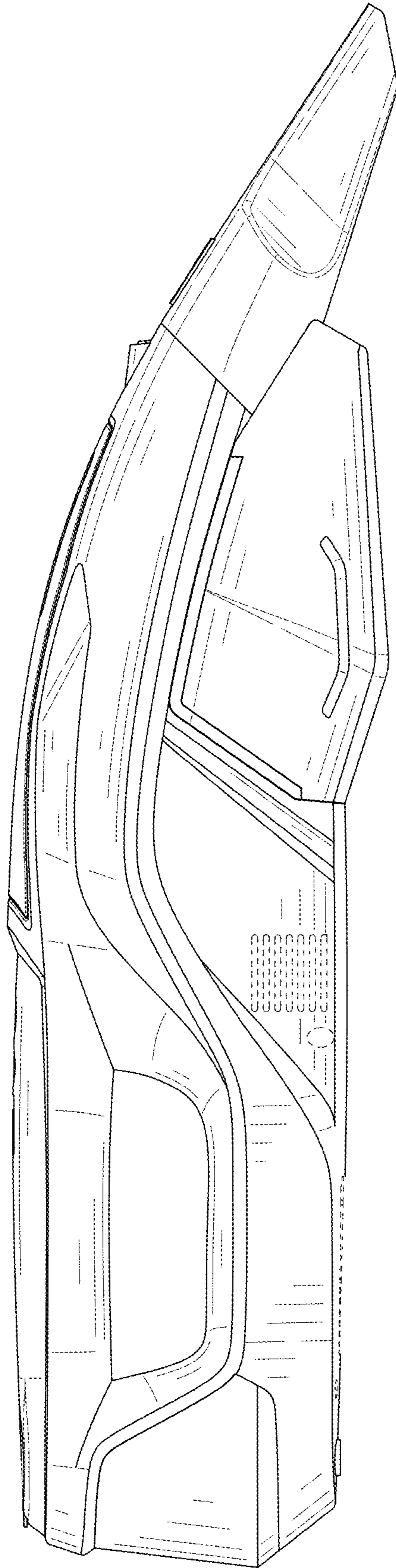

FIG. 4

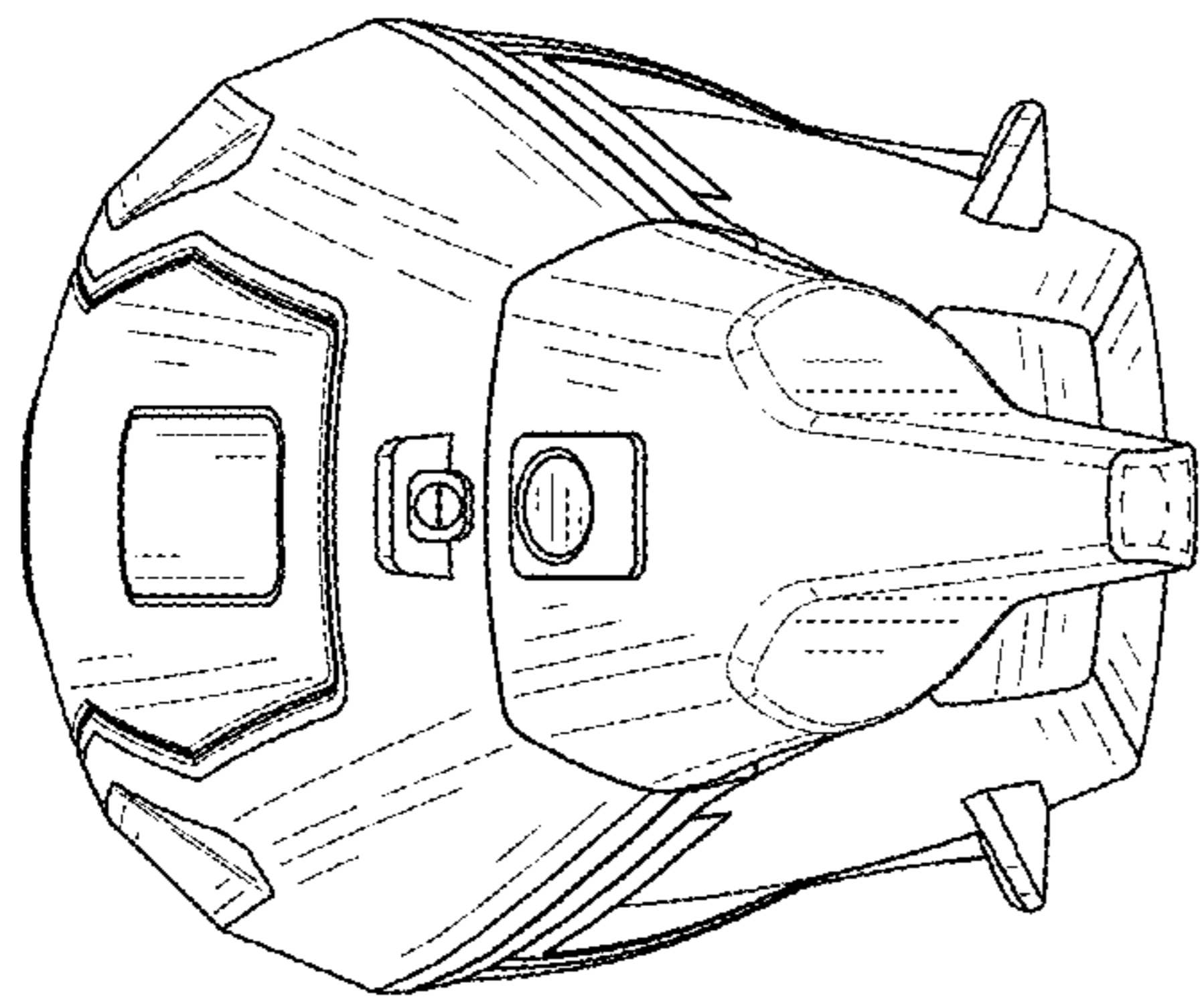

FIG. 5

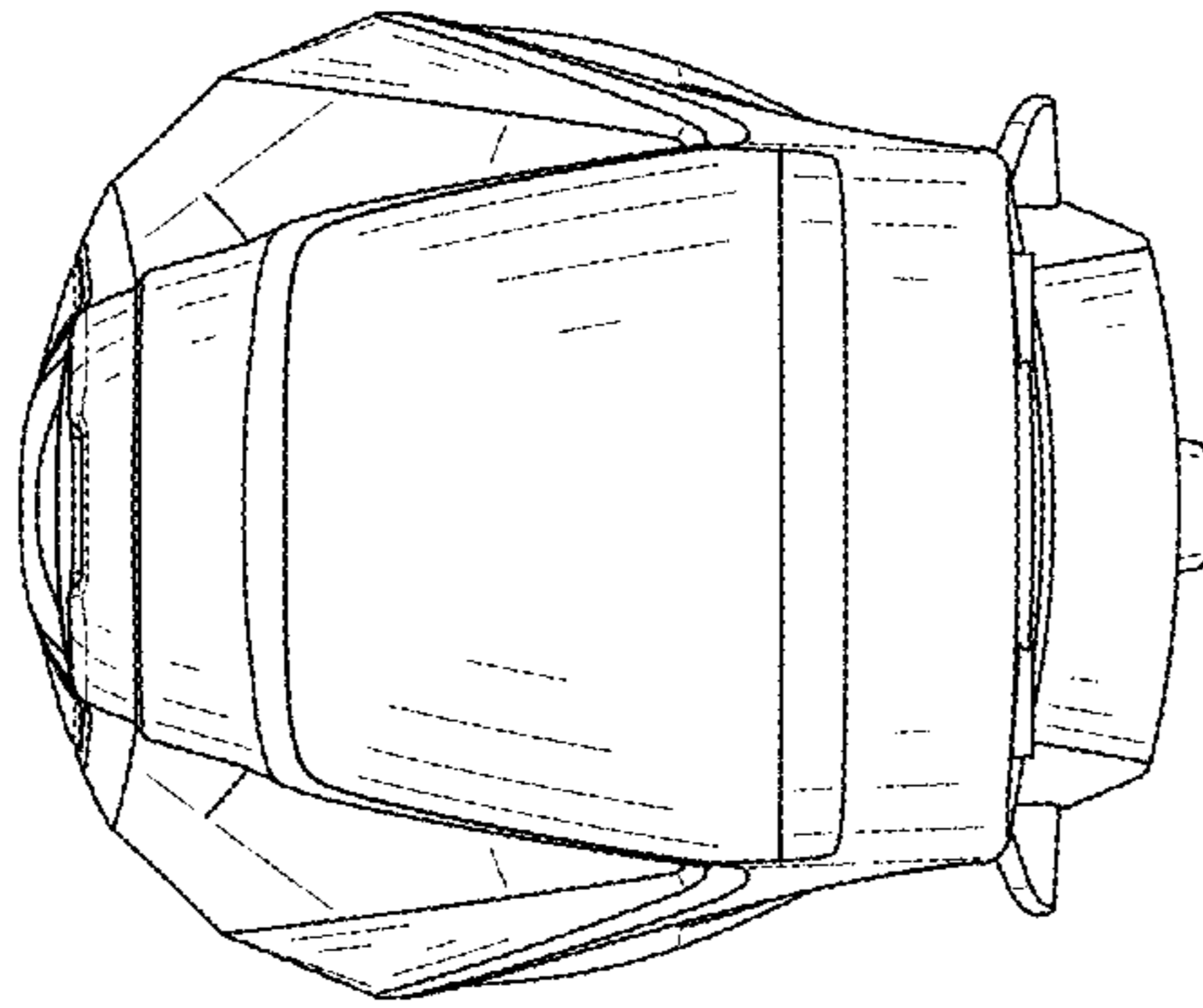

FIG. 6

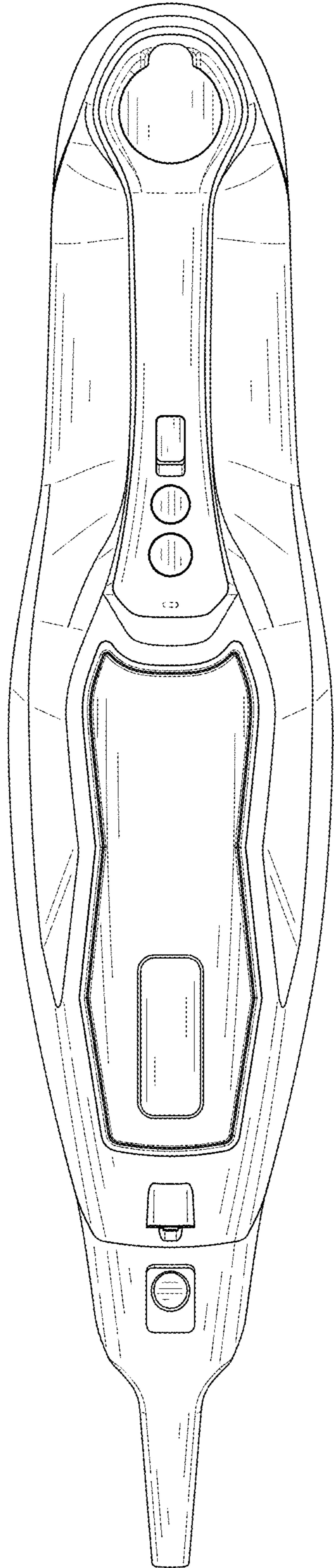

FIG. 7



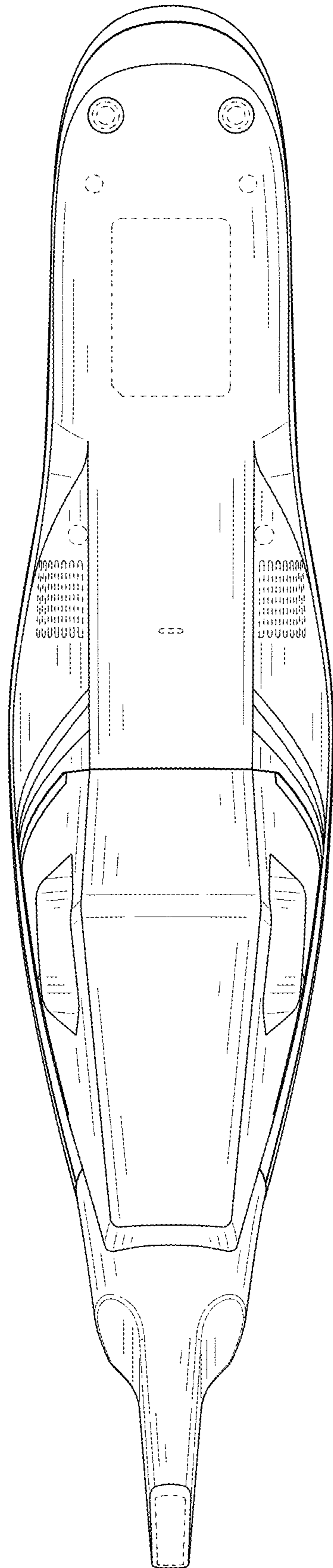

FIG. 8