



US00D936192S

(12) **United States Design Patent** (10) **Patent No.:** **US D936,192 S**
Bucher (45) **Date of Patent:** **** Nov. 16, 2021**

(54) **SINK**

FOREIGN PATENT DOCUMENTS

(71) Applicant: **AS America, Inc.**, Piscataway, NJ (US)

CA 2 639 213 2/2014
CA 2 882 716 8/2015

(72) Inventor: **Christophe Bucher**, Hillsborough, NJ (US)

(Continued)

(73) Assignee: **AS America, Inc.**, Piscataway, NJ (US)

OTHER PUBLICATIONS

(**) Term: **15 Years**

Amazon, Renaissance Double French farmhouse sink, posted Oct. 13, 2016, [online], [visited Jun. 24, 2021]. Internet, <URL: https://www.amazon.co.uk/Renaissance-Double-French-Farmhouse-Sink/dp/B01M5B5HRF/ref> (Year: 2016).*

(21) Appl. No.: **29/692,304**

(Continued)

(22) Filed: **May 23, 2019**

Related U.S. Application Data

(63) Continuation of application No. 29/642,675, filed on Mar. 30, 2018, now Pat. No. Des. 849,895.

(51) **LOC (13) Cl.** **23-02**

(52) **U.S. Cl.**
USPC **D23/290**

(58) **Field of Classification Search**

USPC ... D23/270, 284, 286, 293.1, 303, 308, 285, D23/289, 499, 290, 287; D6/524, 641, D6/642
CPC ... E03C 1/12; E03C 1/18; E03C 1/181; E03C 1/182; E03C 1/184; E03C 1/186; A47K 1/04; A47K 1/00; A47K 1/05; A47K 1/10; A47K 1/12; A47B 77/06; A47J 47/20

See application file for complete search history.

(56) **References Cited**

U.S. PATENT DOCUMENTS

6,182,305 B1 2/2001 O'Connell et al.
D498,291 S 11/2004 Bayer
D504,496 S 4/2005 Bayer
D505,188 S 5/2005 Bayer
D508,555 S 8/2005 Ziemann
D518,561 S 4/2006 Gordon
D523,540 S 6/2006 Gordon

(Continued)

Primary Examiner — Sheryl Lane

Assistant Examiner — Samantha N Wood

(74) *Attorney, Agent, or Firm* — Morrison & Foerster LLP

(57) **CLAIM**

I claim the ornamental design for a sink, as shown and described.

DESCRIPTION

FIG. 1 is a front perspective view of a sink showing my new design;

FIG. 2 is a front view thereof;

FIG. 3 is a rear view thereof;

FIG. 4 is a side view thereof;

FIG. 5 is a side view of the opposite side of FIG. 4;

FIG. 6 is a top view thereof; and,

FIG. 7 is a bottom view thereof.

The broken lines using uniform dashes shown in the drawings illustrate portions of a sink that form no part of the claimed design.

The broken lines using uneven dashes (i.e., the dot-dashed lines) in FIG. 1 indicate bounds of the claimed design and form no part thereof. Thus, the area inside the dot-dashed rectangle does not indicate a wall or surface that is part of the claimed design.

1 Claim, 7 Drawing Sheets

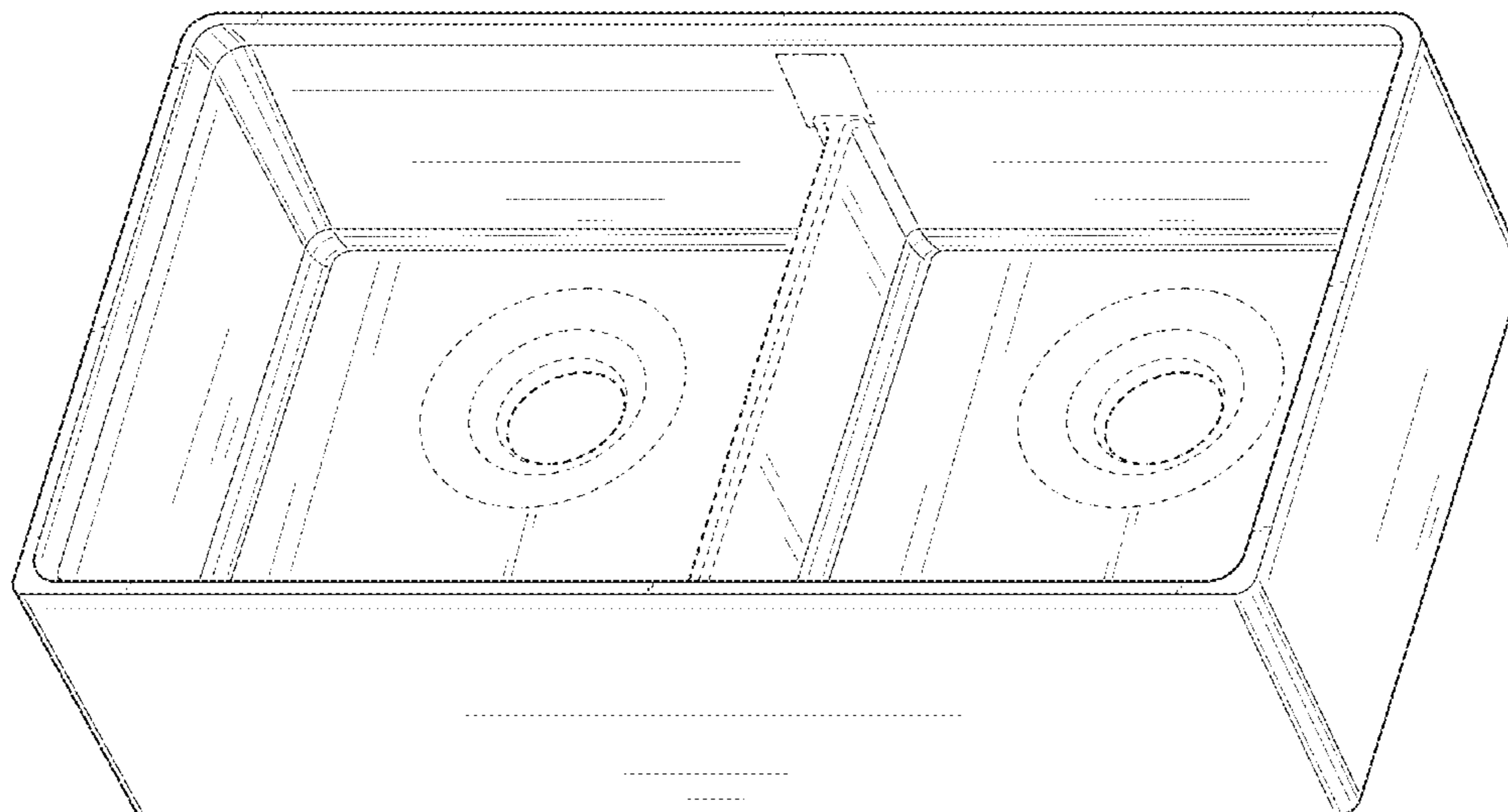

(56)

References Cited

FOREIGN PATENT DOCUMENTS

U.S. PATENT DOCUMENTS

D541,912 S 5/2007 Ziemann
 D547,833 S 7/2007 Mahon
 D548,311 S 8/2007 Mahon
 D585,126 S 1/2009 Eilmus et al.
 D586,445 S 2/2009 Ziemann et al.
 D587,351 S 2/2009 Eilmus et al.
 D588,246 S 3/2009 Eilmus et al.
 D601,675 S 10/2009 Booth et al.
 D603,484 S 11/2009 Eilmus
 D607,979 S * 1/2010 Jiang D23/293.1
 D622,826 S 8/2010 Helmer
 D627,449 S 11/2010 Eckhaus
 D656,228 S 3/2012 Booth
 D669,560 S 10/2012 Booth
 D670,364 S 11/2012 Miller et al.
 D677,772 S 3/2013 Mendoza et al.
 D703,799 S 4/2014 Eilmus et al.
 D707,802 S * 6/2014 Jepson D23/290
 D767,738 S 9/2016 Osterroth et al.
 RE46,298 E 2/2017 Eilmus
 9,574,333 B2 2/2017 O'Brien et al.
 D782,018 S 3/2017 Eilmus et al.
 9,775,470 B2 10/2017 Eilmus et al.
 9,783,967 B2 10/2017 Jain et al.
 D804,620 S 12/2017 Palazzolo et al.
 D816,197 S 4/2018 Chong et al.
 D858,722 S 9/2019 Bucher
 2006/0242761 A1 11/2006 Babick et al.
 2012/0266377 A1 10/2012 Eilmus

CN 301999934 7/2012
 CN 303455909 11/2015
 DE 102015107145 A1 * 11/2016 A47K 1/05
 EP 0 900 543 3/1999
 EP 1 776 898 11/2010
 EP 1 856 339 12/2012

OTHER PUBLICATIONS

Amazon, Clickbasin rectangular bathroom sink, posted Jun. 30, 2016, [online], [visited Jun. 24, 2021]. Internet, <URL: <https://www.amazon.co.uk/Clickbasin-Trieste-Rectangular-Countertop-Ceramic/dp/B01HTSGKB8/ref>> (Year: 2016).*

Bucher, U.S. Office Action dated Dec. 12, 2018, directed to U.S. Appl. No. 29/642,676; 5 pages.

First Rectification Notification dated Dec. 18, 2018, directed to CN Application No. 201830544103.3; 2 pages.

Home Depot. (2014) "Whitehaus Collection, Duet Reversible Farmhaus Apron Front Fireclay 30 in. Single Bowl Kitchen Sink in White," located at https://www.homedepot.com/p/Whitehaus-Collection-Duet-Reversible-Farmhaus-Apron-Front-Fireclay-30-in-Single-Bowl-Kitchen-Sink-in-White-WH3018-WH/203865941?MERCH=REC_-PIPHorizontal2_rr_-203866193_-203865941_-N (1 page).

Notification to Grant Patent Right dated Mar. 25, 2019, directed to CN Application No. 201830544103.3; 6 pages.

Shalees Diner Decor. (Dec. 11, 2015) "Single Basin Kitchen Sink Photo," located at <https://shaleesdiner.com/the-advantages-of-single-basin-kitchen-sink/single-basin-kitchen-sink-photo/> (1 page).

* cited by examiner

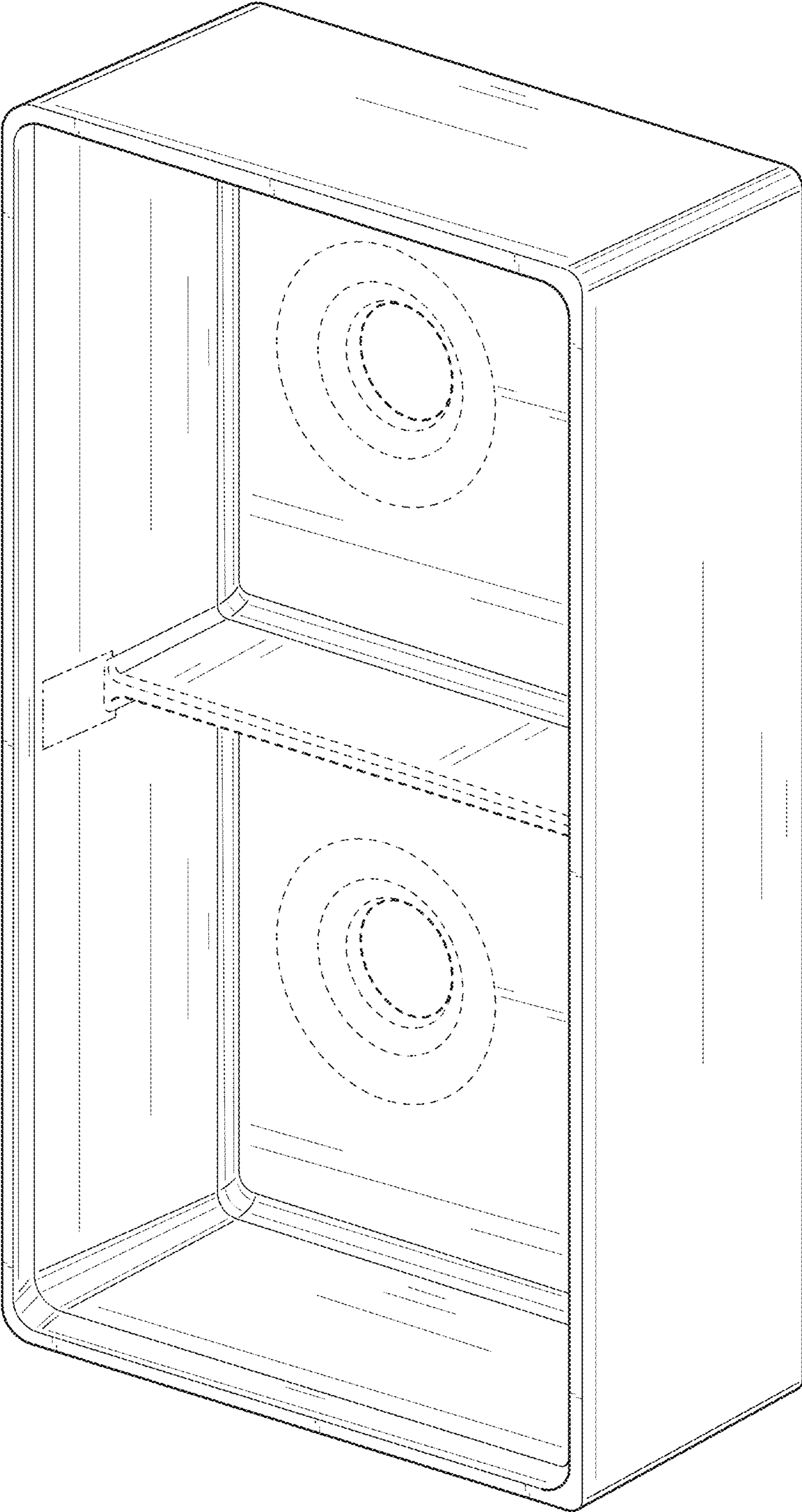

FIG. 1

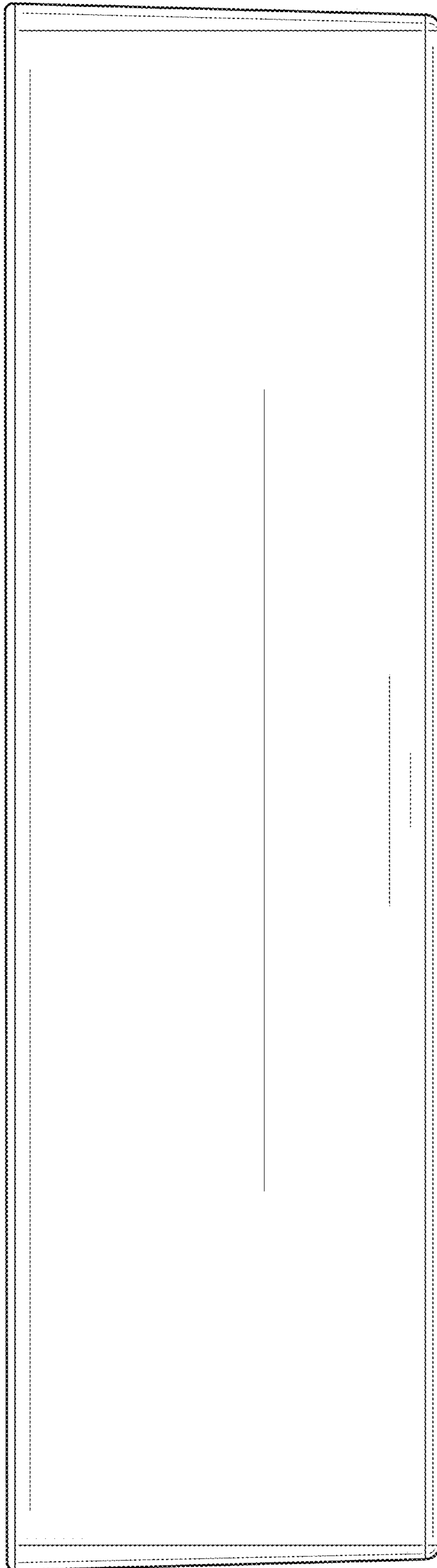

FIG. 2

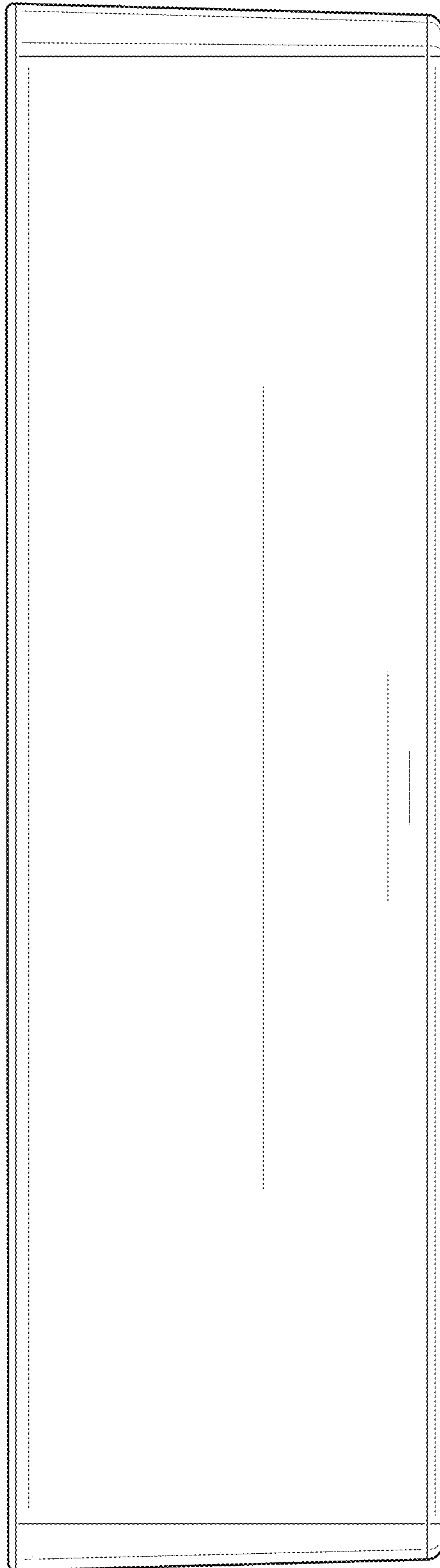

FIG. 3

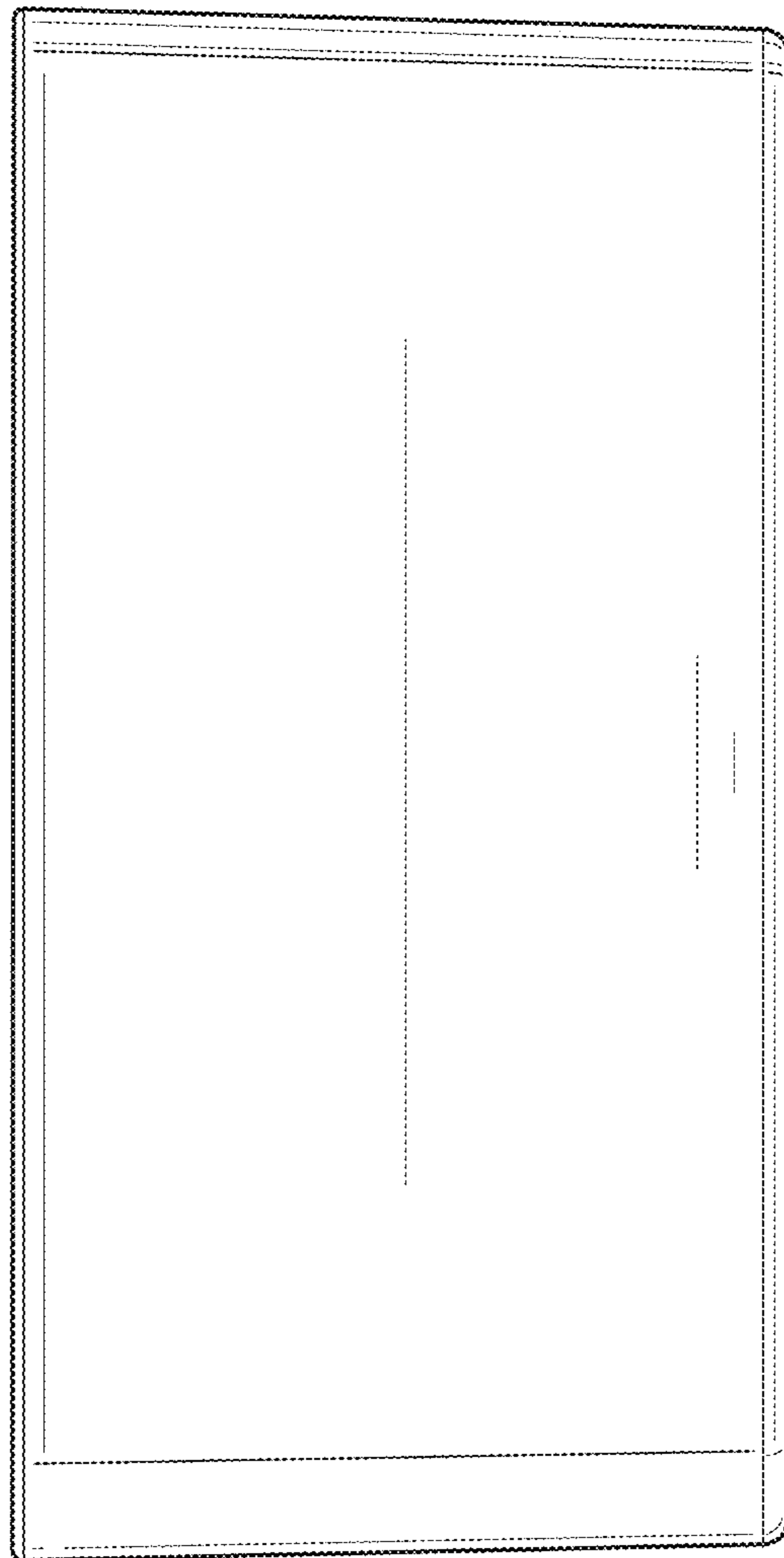

FIG. 4

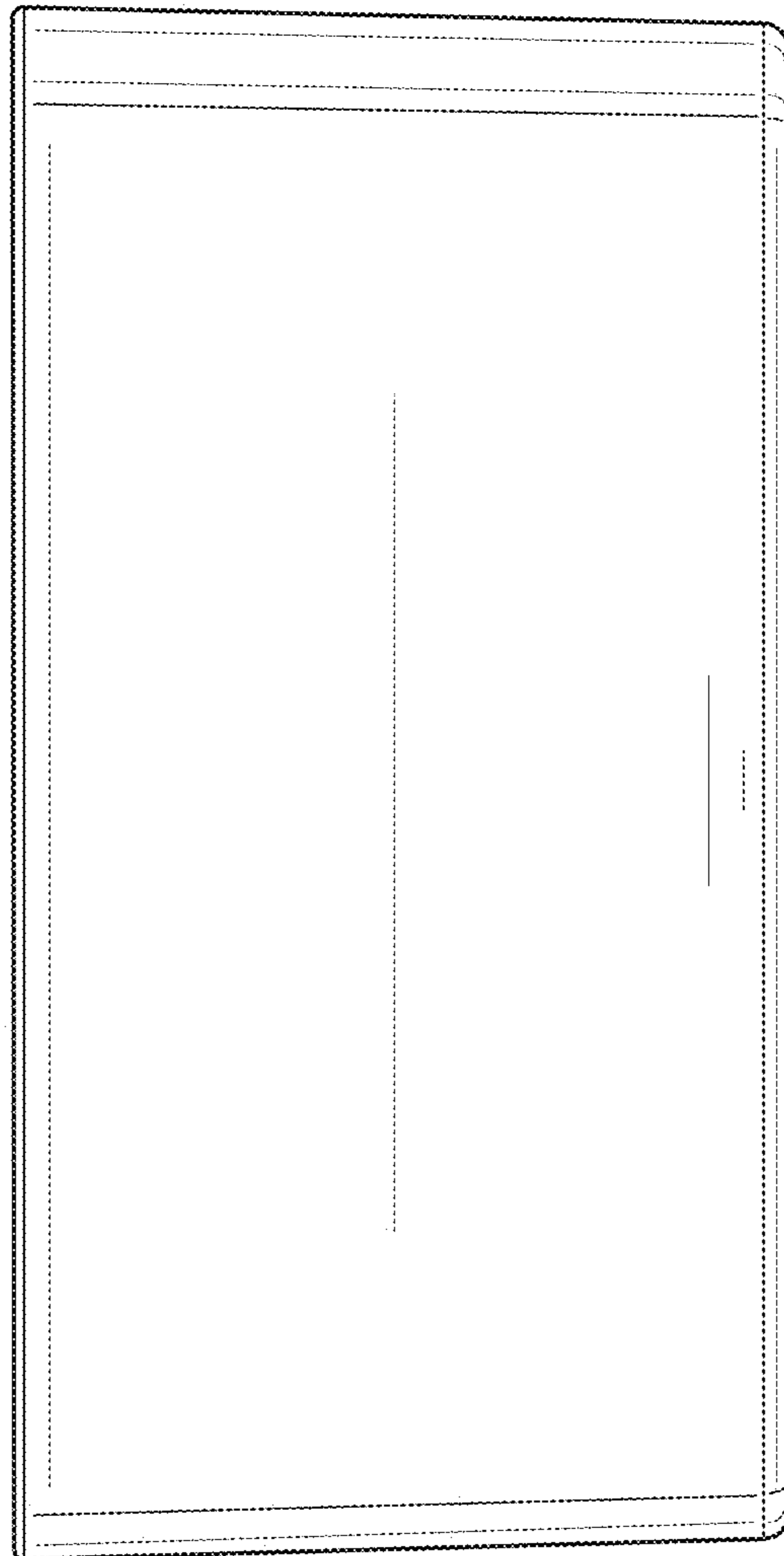

FIG. 5

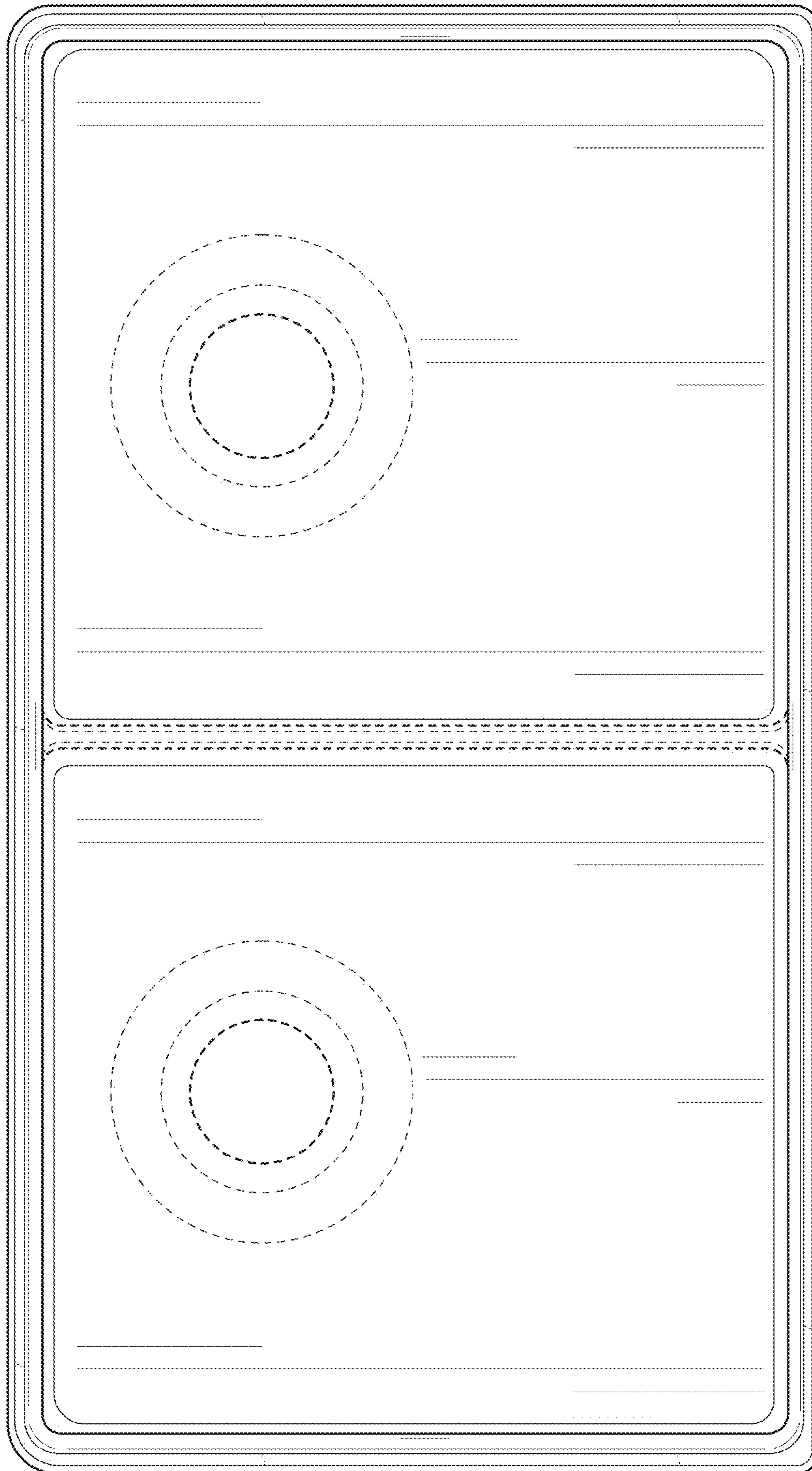

FIG. 6

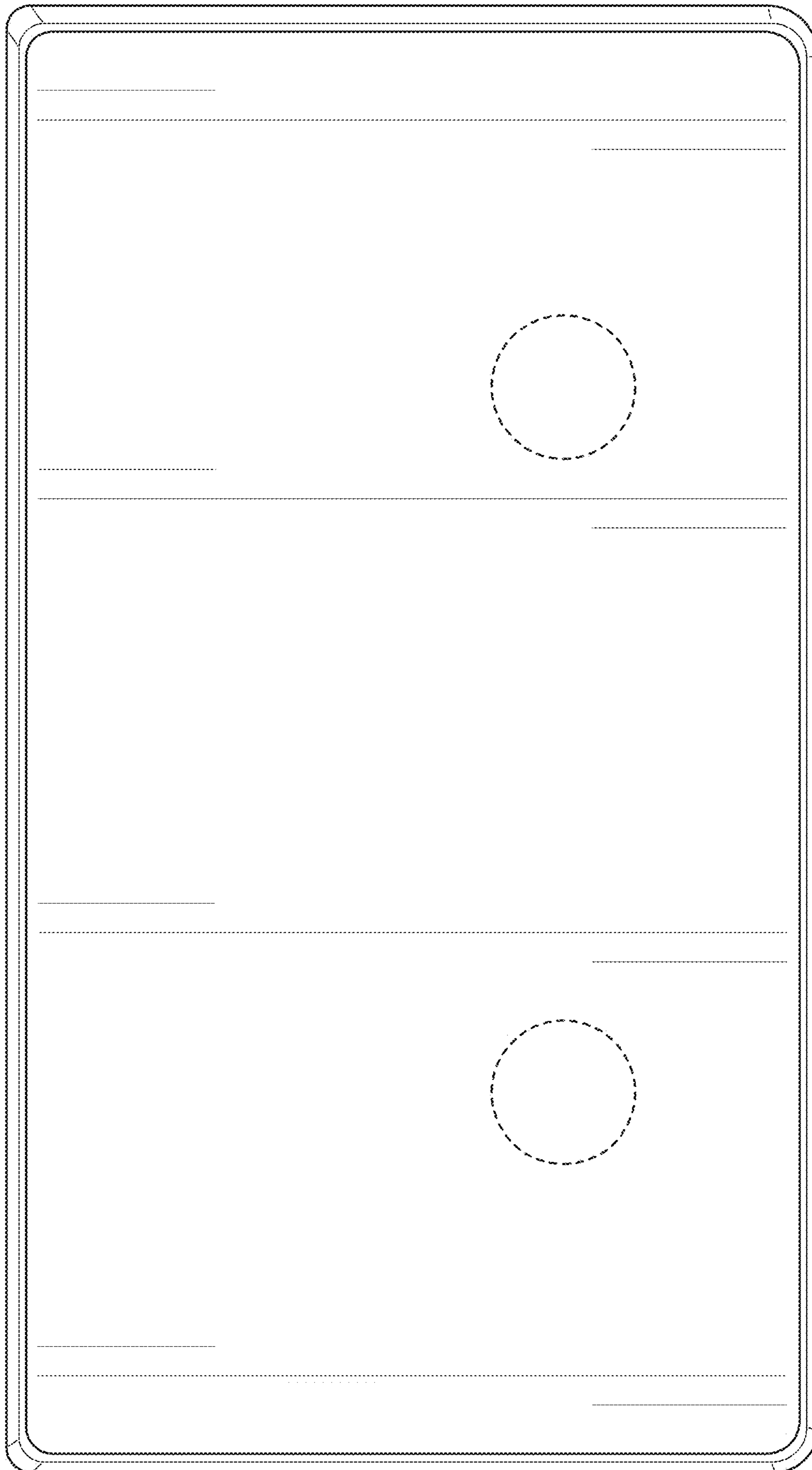

FIG. 7