



US00D936188S

(12) **United States Design Patent**
Cohen

(10) **Patent No.:** **US D936,188 S**

(45) **Date of Patent:** **** Nov. 16, 2021**

(54) **ROUND SEDIMENT DRAIN BASKET ASSEMBLY**

(71) Applicant: **TNT Products, Inc.**, Simi Valley, CA (US)

(72) Inventor: **Todd Russell Cohen**, Simi Valley, CA (US)

(73) Assignee: **TNT Products, Inc.**, Simi Valley, CA (US)

(**) Term: **15 Years**

(21) Appl. No.: **29/729,374**

(22) Filed: **Mar. 26, 2020**

(51) **LOC (13) Cl.** **23-01**

(52) **U.S. Cl.**
USPC **D23/261**

(58) **Field of Classification Search**
USPC 210/162-166, 499, 464, 482, 167.1, 210/167.12, 167.15; D23/259-261, 206, D23/208-209, 365, 267-268; D7/300.1, D7/369, 400, 667; 4/256.1, 286-295, 4/679, 688-689, 507-508, 510, 513; 137/247.33, 545-547; D9/435-436, 447; D27/194; D30/128, 132; 47/14, 61; D32/55; D25/152, 156; 52/12-13, 101
CPC E03C 1/12; E04H 4/1272; A01G 3/02; B65D 43/0231; E03F 2005/068
See application file for complete search history.

(56) **References Cited**

U.S. PATENT DOCUMENTS

- 3,711,874 A * 1/1973 Gajer E03C 1/264 4/287
- 4,423,527 A * 1/1984 Morris E03F 5/0407 4/288
- RE31,561 E * 4/1984 Thompson E03C 1/26 4/286

(Continued)

OTHER PUBLICATIONS

Guardian Drain Lock Duo 2 in 1 Basket 2 Piece Commercial Floor Sink Sediment Strainer; Guardian lock.com; Visited Online Sep. 21, 2021; <https://guardiandrainlock.com/collections/frontpage/products/guardian-drain-lock-duo-2-in-1-basket> (Year: 2021).*

(Continued)

Primary Examiner — Amy C Wierenga

(74) *Attorney, Agent, or Firm* — Gregory B. Wood

(57) **CLAIM**

The ornamental design for a round sediment drain basket assembly, as shown and described.

DESCRIPTION

FIG. 1 is a perspective view of a round sediment drain basket assembly.
 FIG. 2 is a front side view thereof.
 FIG. 3 is a top view thereof.
 FIG. 4 is a bottom view thereof.
 FIG. 5 is a left side view thereof.
 FIG. 6 is a right side view thereof.
 FIG. 7 is a rear side view thereof.
 FIG. 8 is an exploded top perspective view of an inner and outer members of the round sediment drain basket assembly.
 FIG. 9 is an exploded front perspective view of the inner and outer members of the round sediment drain basket assembly.
 FIG. 10 is an exploded left side view of the round sediment drain basket assembly.
 FIG. 11 is an exploded right side view of the round sediment drain basket assembly; and,
 FIG. 12 is an exploded rear view of the round sediment drain basket assembly.

1 Claim, 10 Drawing Sheets

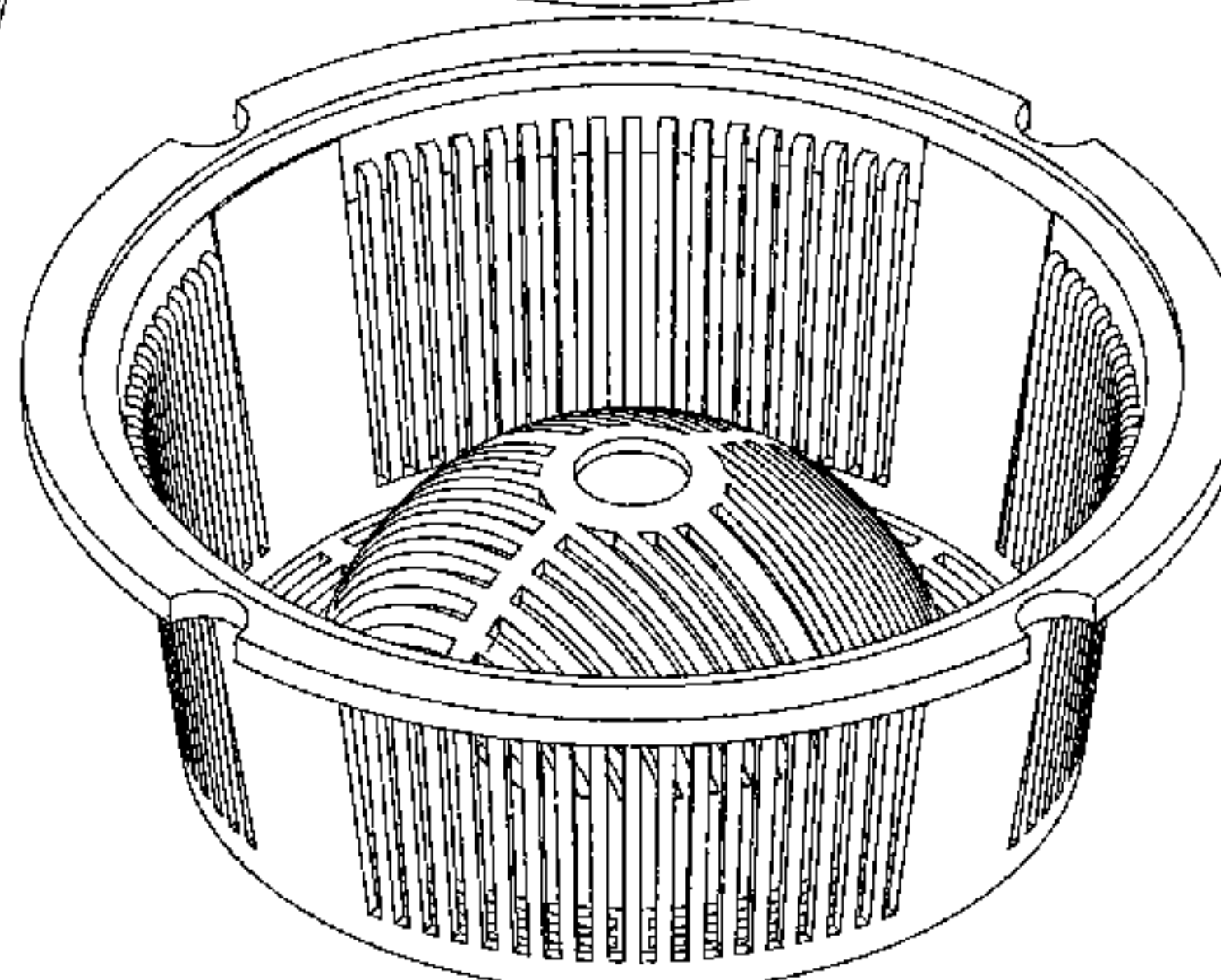
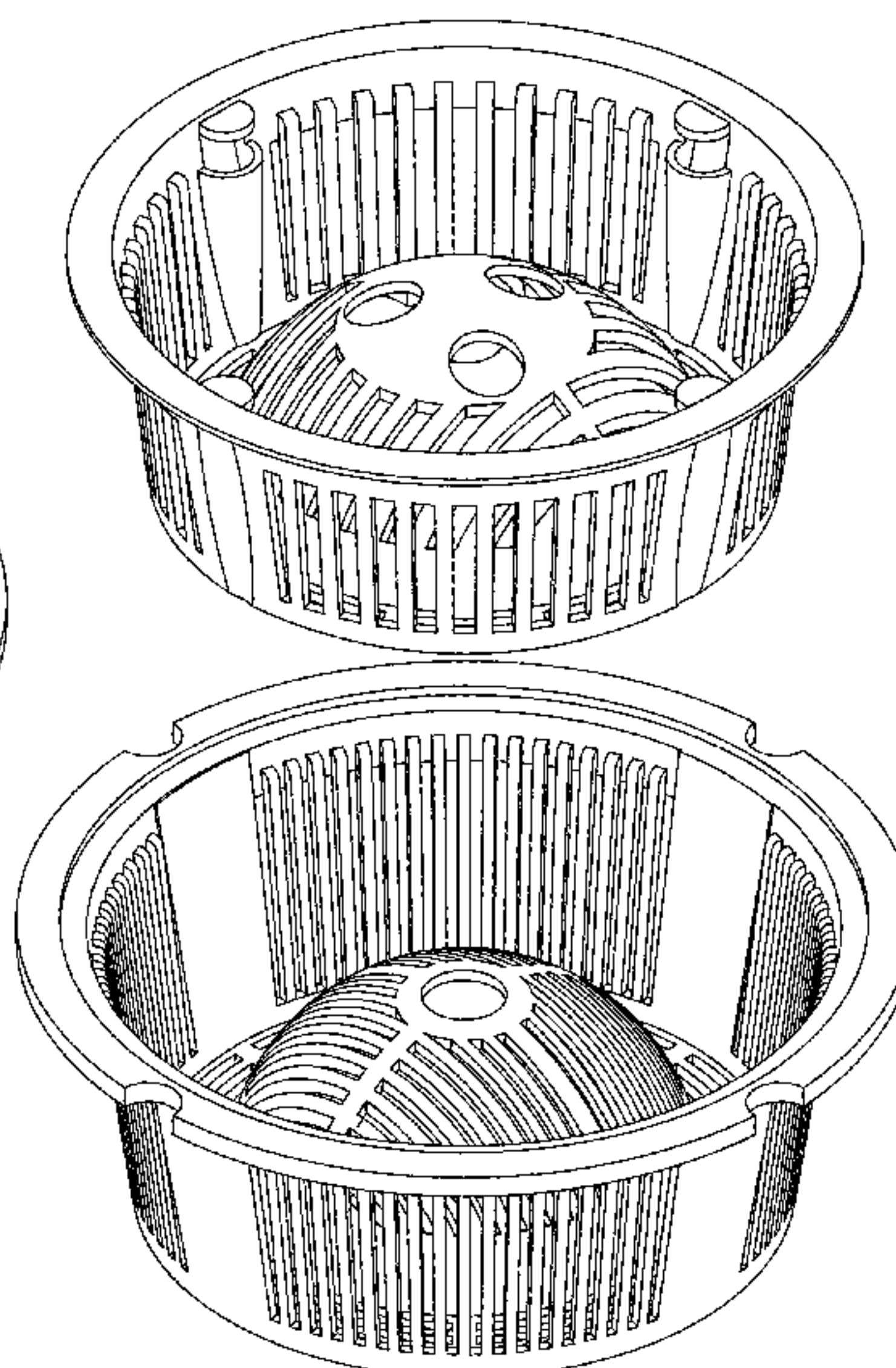
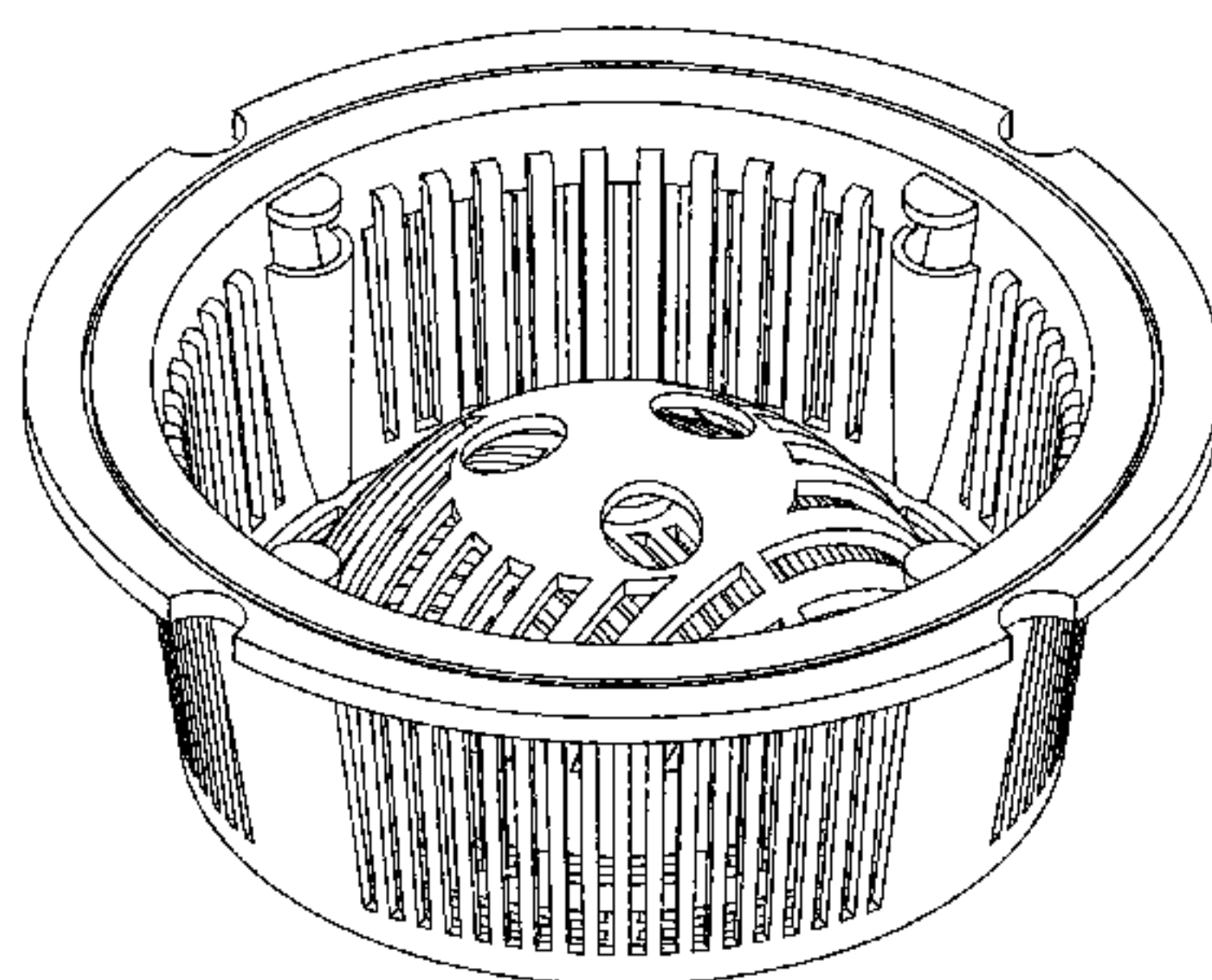

(56)

References Cited

U.S. PATENT DOCUMENTS

5,369,815 A * 12/1994 Martin A47K 1/14
4/287
6,108,828 A * 8/2000 Cheng A47K 1/14
4/286
D550,805 S * 9/2007 Hazlehurst D23/209
D613,829 S * 4/2010 Griffin D23/260
D673,246 S * 12/2012 Lee D23/260
D749,706 S * 2/2016 Johansen D23/260
D792,562 S * 7/2017 Ali D23/261
11,085,179 B1 * 8/2021 Cohen E03C 1/264
2008/0295236 A1 * 12/2008 Eichler E03F 5/02
4/292
2008/0307573 A1 * 12/2008 Ho E03C 1/264
4/292
2010/0206969 A1 * 8/2010 Strong E03C 1/26
241/101.01
2014/0158593 A1 * 6/2014 Chien E03F 5/0404
210/166
2016/0244955 A1 * 8/2016 Allred, III E03C 1/126
2017/0101769 A1 * 4/2017 Scamuffa E03C 1/264
2017/0284077 A1 * 10/2017 Deurloo B01D 29/96
2020/0217055 A1 * 7/2020 Robillard E03F 5/06

OTHER PUBLICATIONS

Guardian Lock Duo 2 in 1 Floor Sink Basket; YouTube video Frame 0:04/3:2; Publish date May 20, 2201 on YouTube.com; Visited Online Sep. 22, 2021; 1https://www.youtube.com/watch?v=dyYVUxlemE4&t=1s (Year: 2021).*

Guardian Drain Lock Duo 2 in 1 basket-2 Piece Commercial Floor Sink Sediment Strainer; First Available Date May 22, 2021; Visited Online Sep. 21, 2021; https://www.amazon.com/Guardian-Drain-Lock-DUO-Basket/dp/B095MC2T7C/ref=sr_1_56_sspa?crid=2DN2CXUKVK9UX&dchild=1&keywords=drain%2Block%2Bdome&qid=1632173760&sprefix=Drain%2Block%2Caps%2C145&sr=8-56-spons&spLa=ZW5jenlwdGVkUXVhbGlmaWVyPUEOUjY0R0RCUFRGMIAmZW5jenlwdGVkSWQ9QTAYOTM1NDkxSFIGNFpXT0s5VFpRjMvY3J5cHRIZEFkSWQ9QTAYOTIyMTOxT1FBQVNWUzFQTDBPJndpZGldE5hbWU9c3BfYnRmJmFjdGlvb j1jbGlja1JIZGIyZWN0JmRvTm90TG9nQ2xpY2s9dHJ1ZQ&th=1 (Year: 2021).*

* cited by examiner

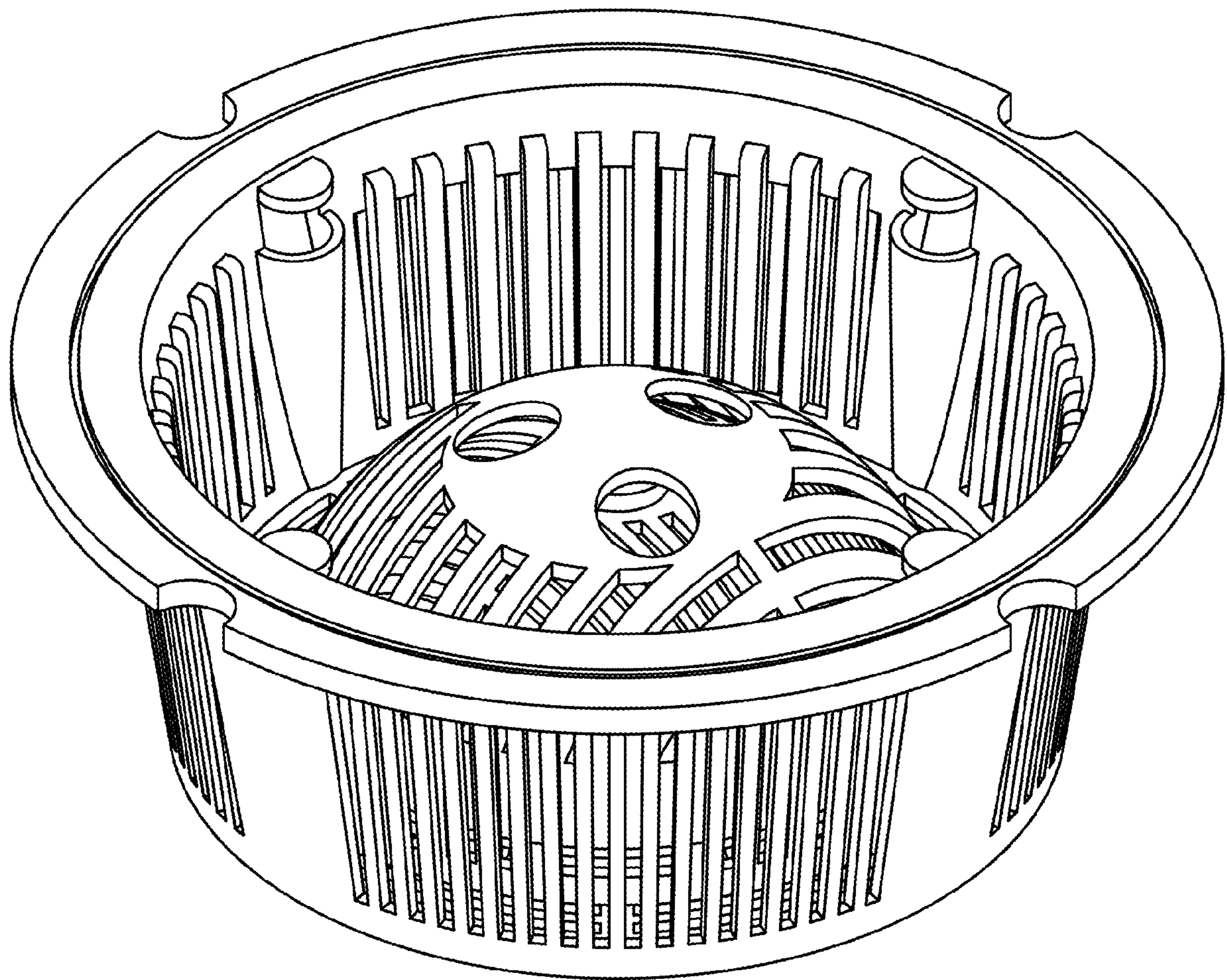

FIG. 1

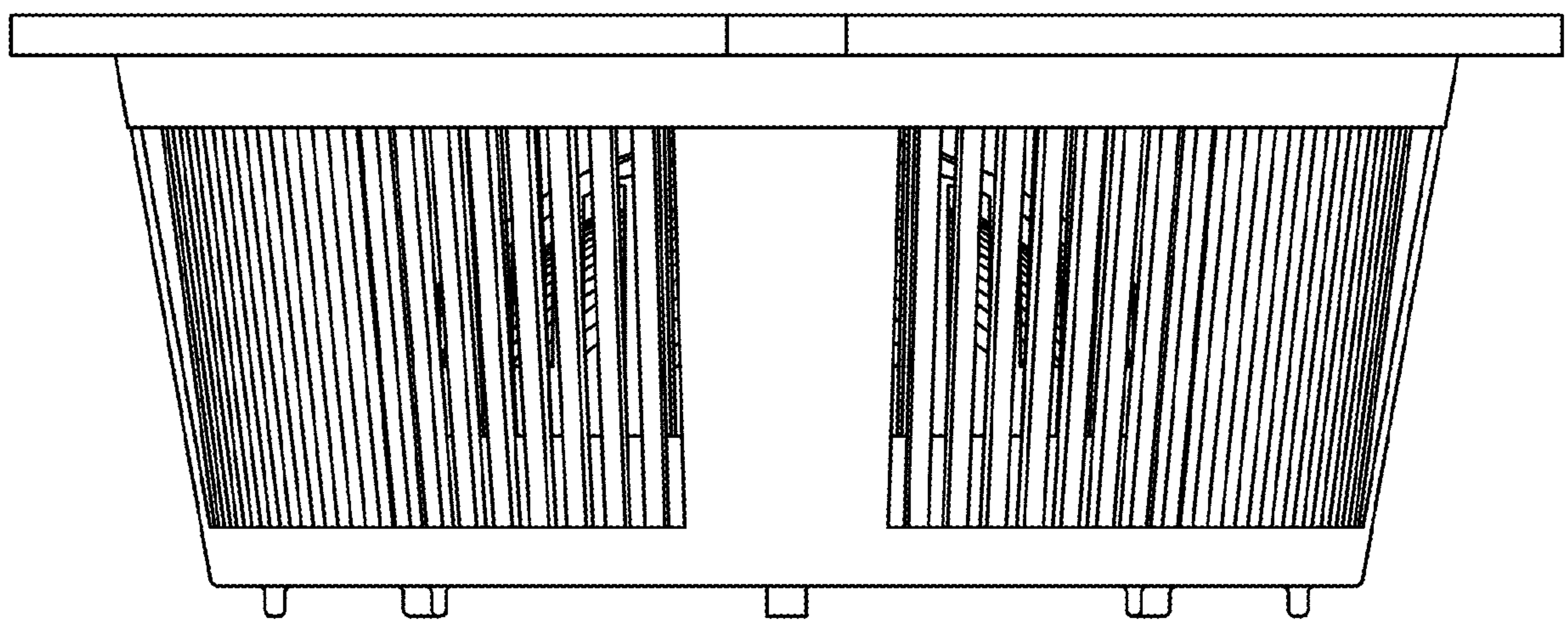

FIG. 2

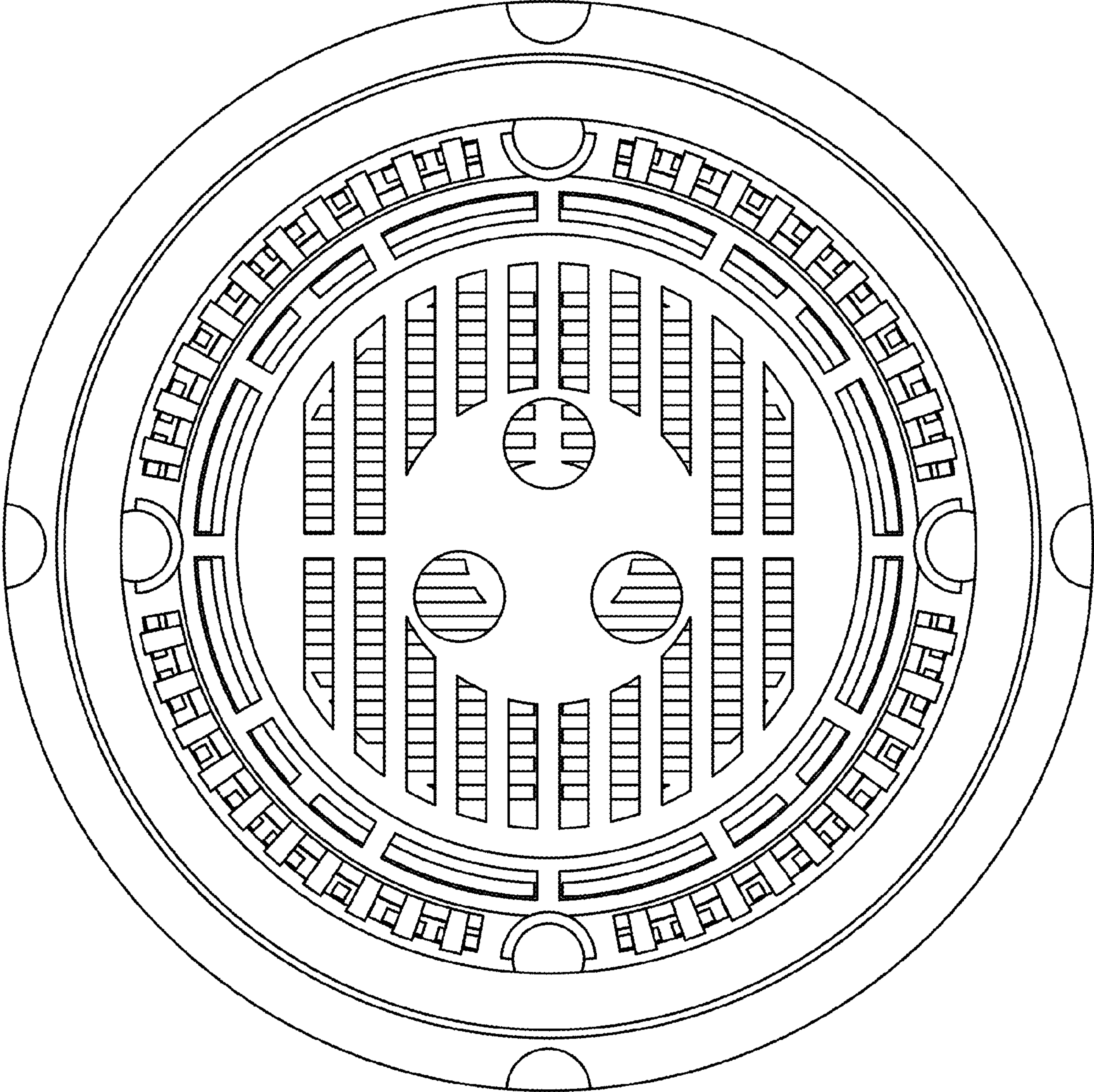

FIG. 3

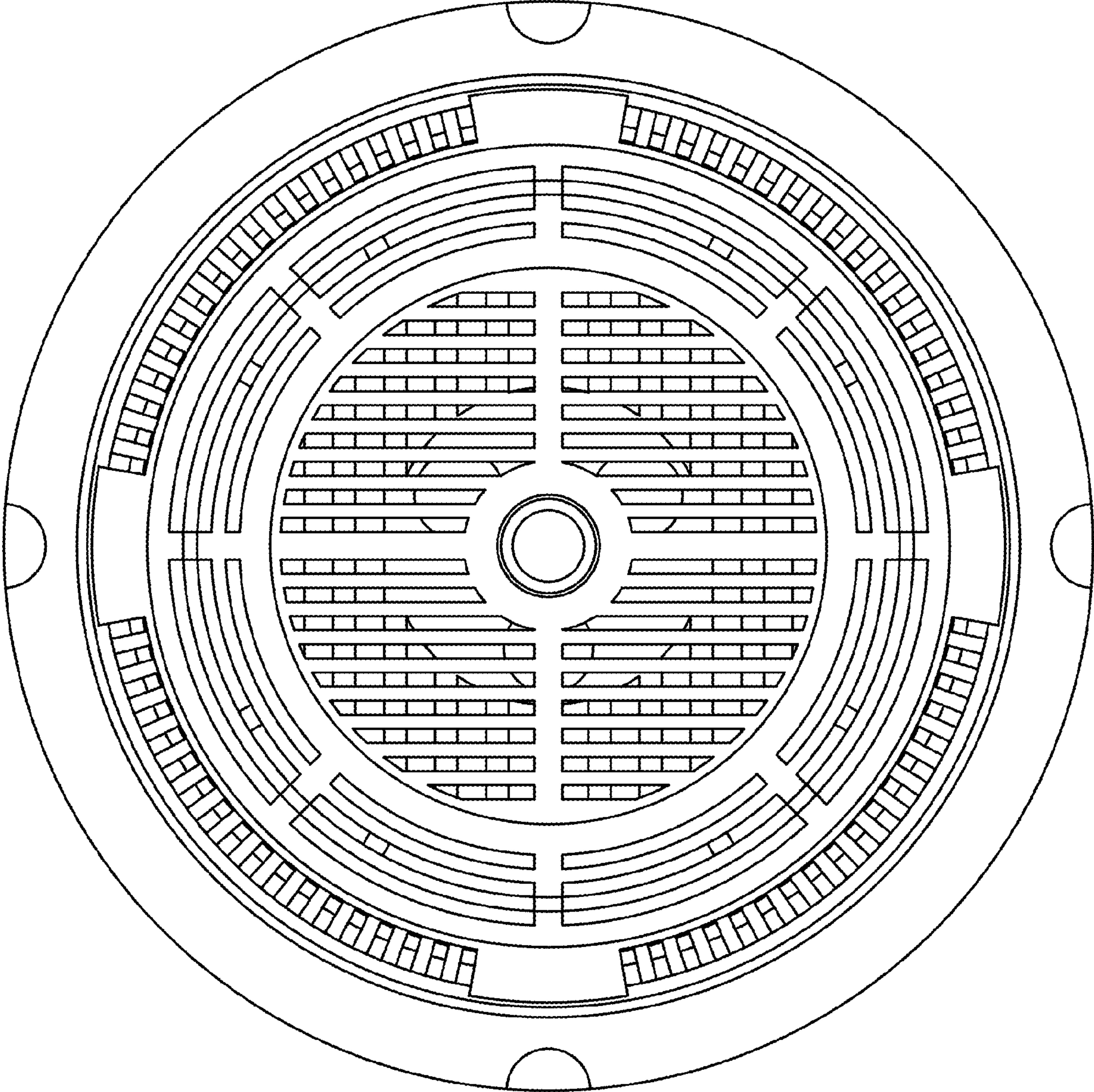

FIG. 4

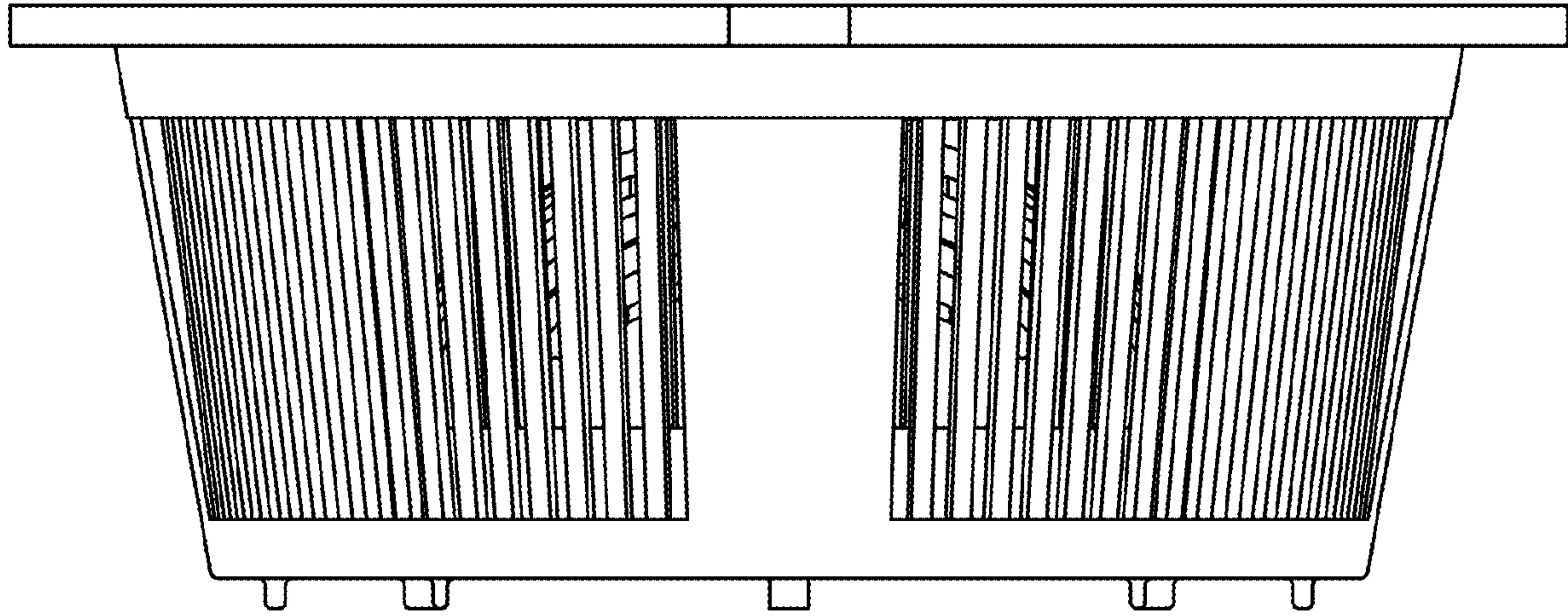

FIG. 5

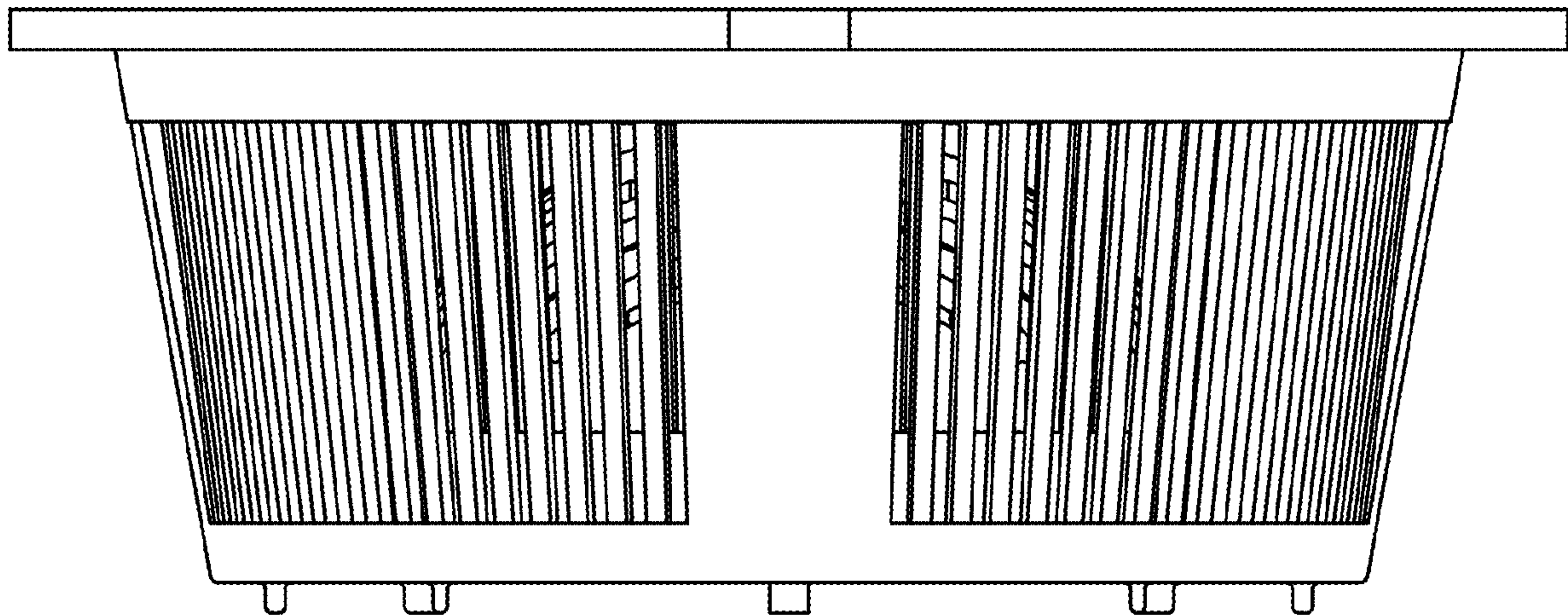

FIG. 6

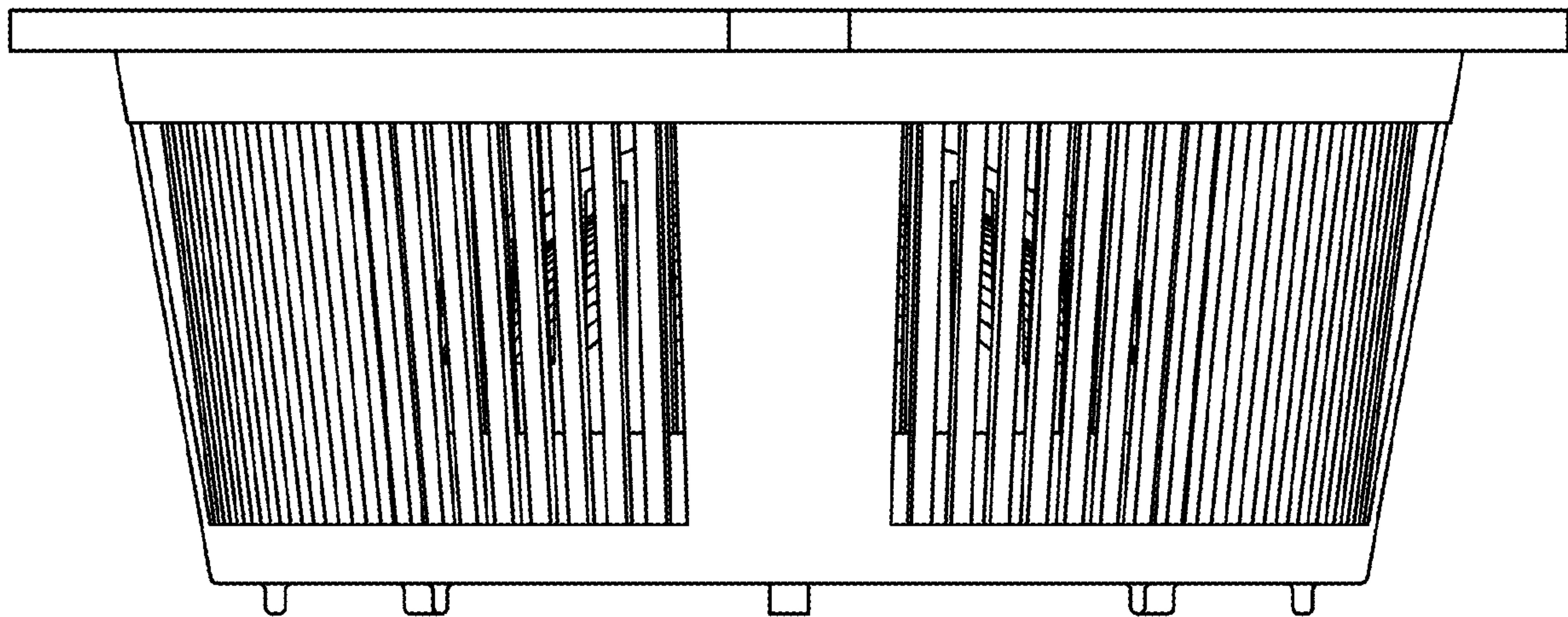

FIG. 7

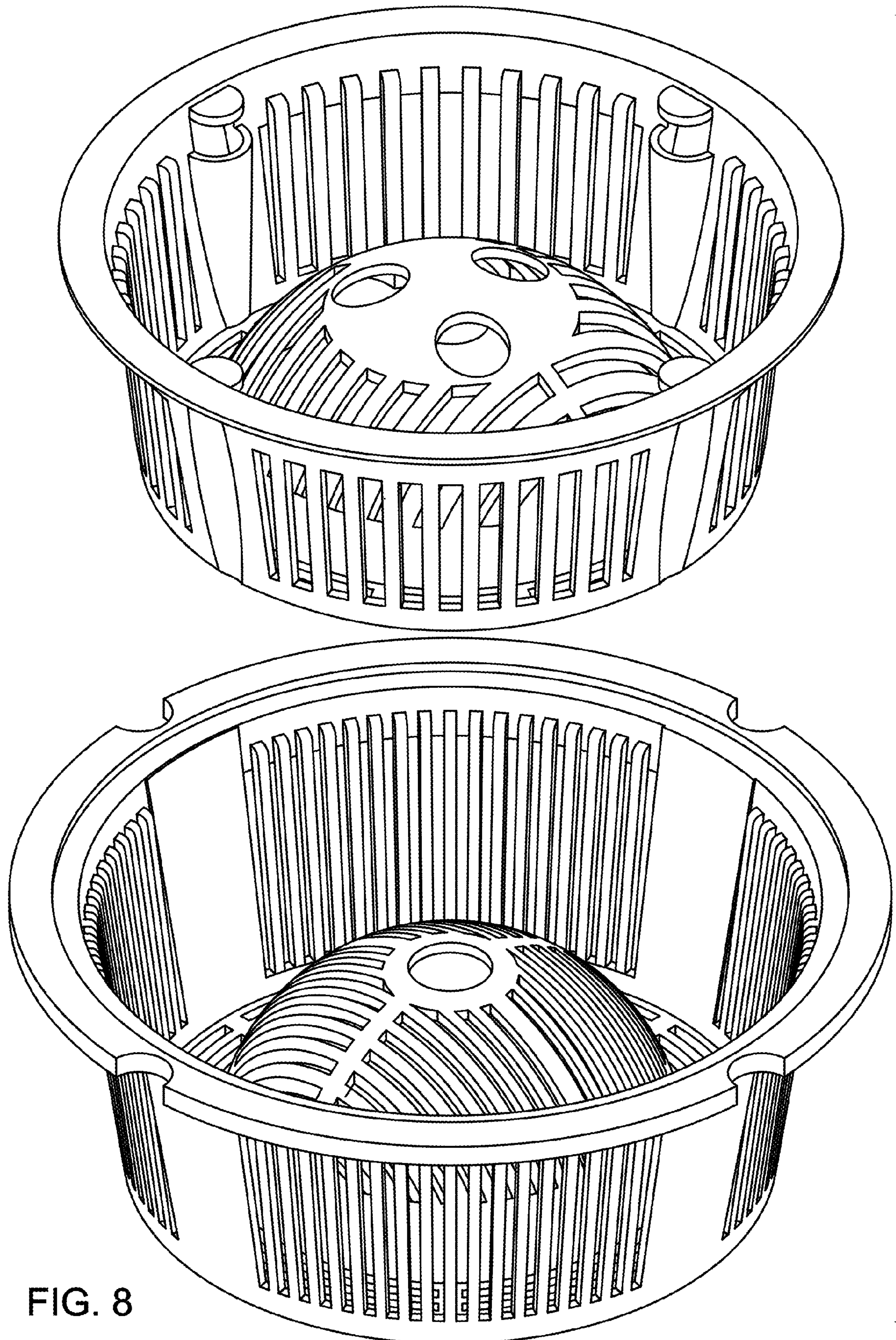

FIG. 8

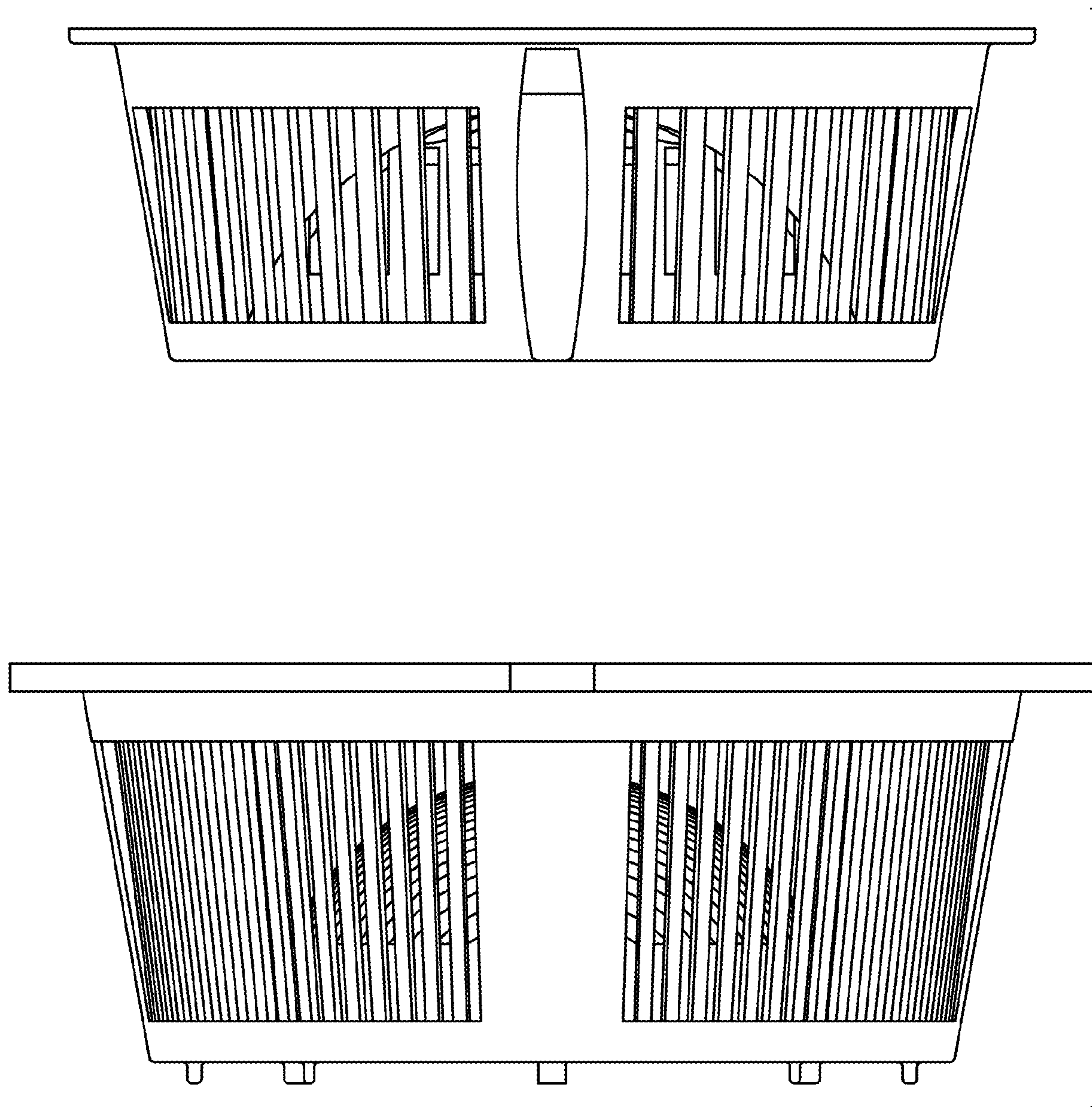

FIG. 9

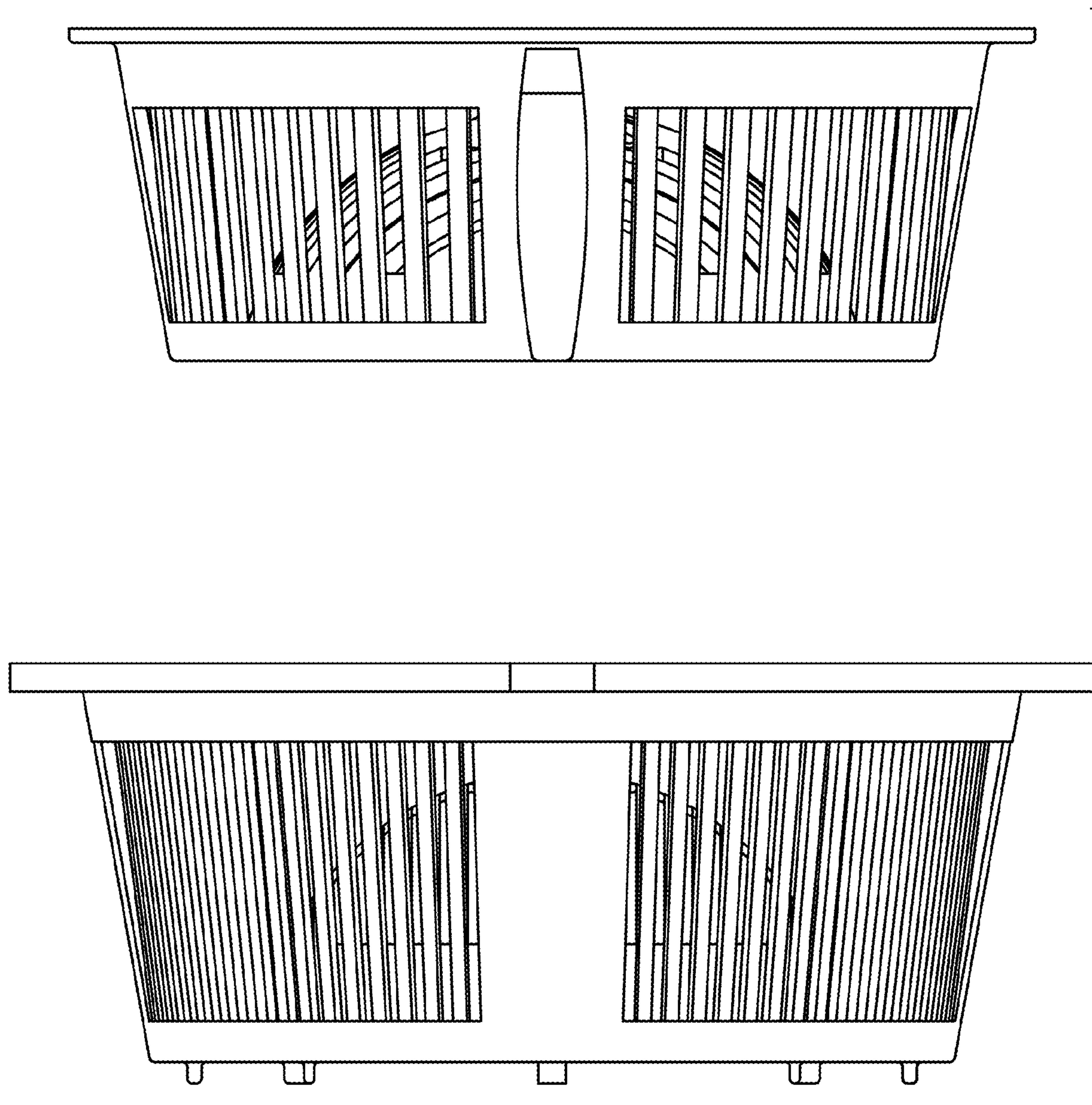

FIG. 10

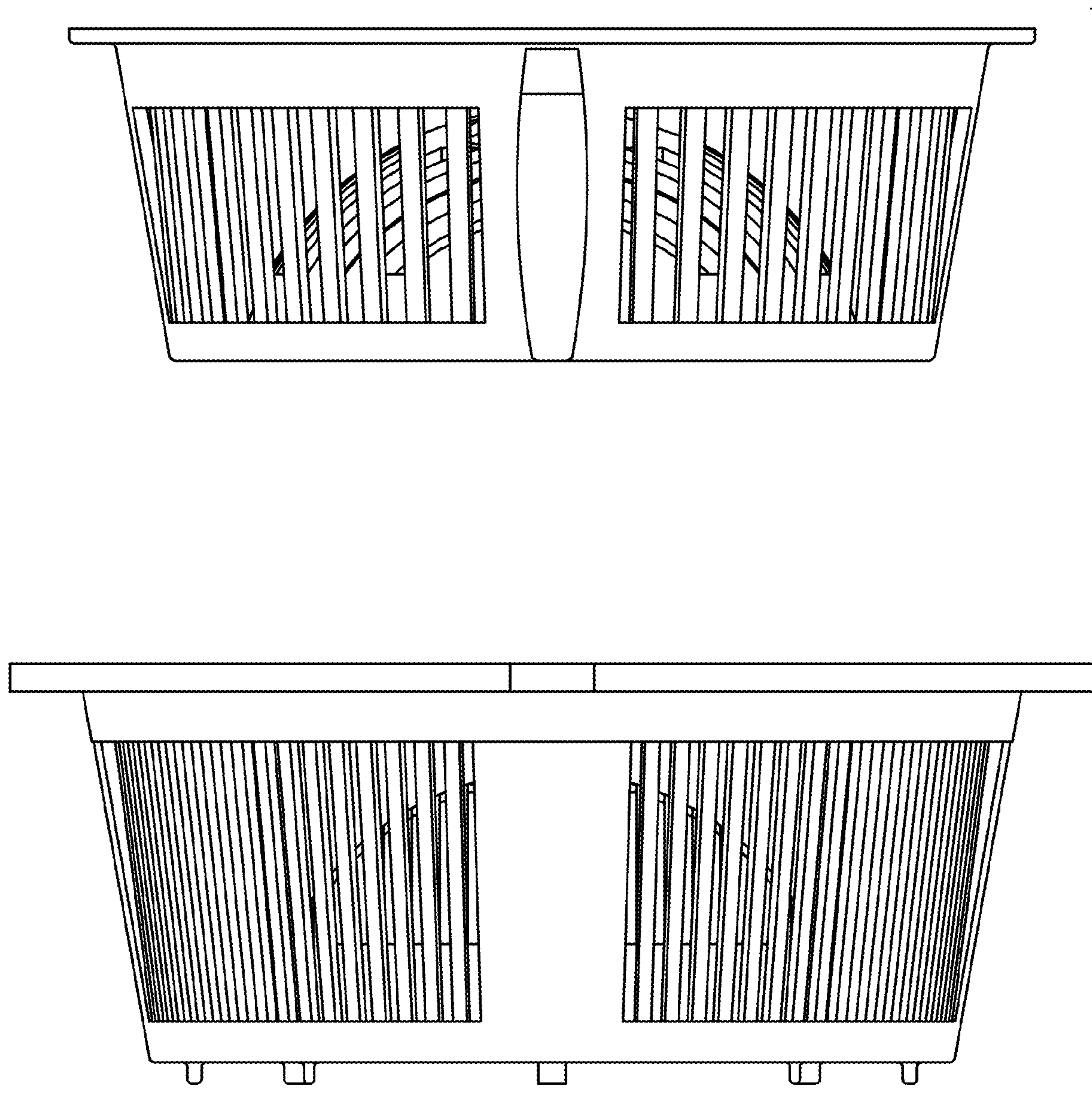

FIG. 11

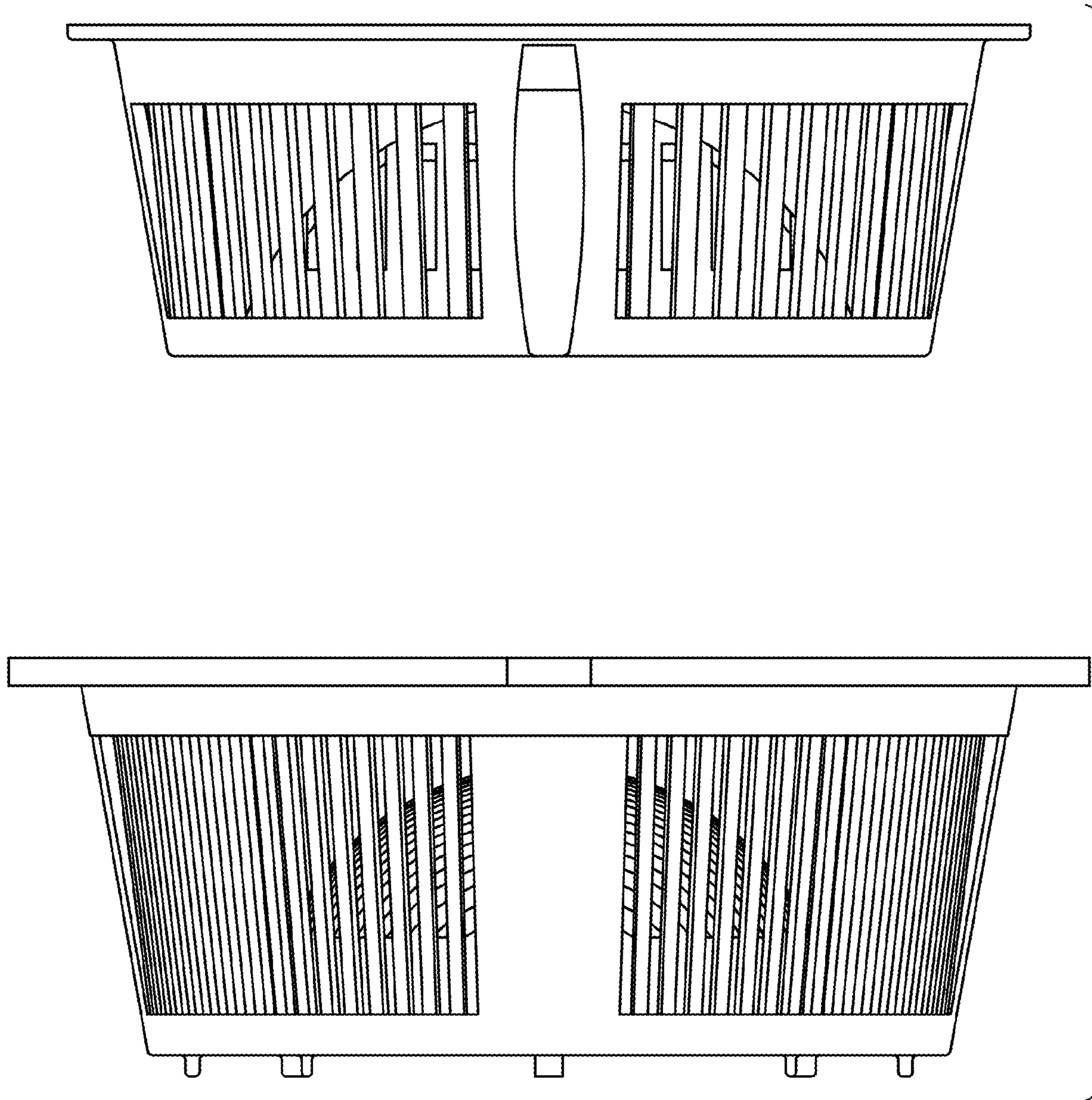

FIG. 12