



US00D936148S

(12) **United States Design Patent** (10) **Patent No.:** **US D936,148 S**
Zhu (45) **Date of Patent:** **** Nov. 16, 2021**

(54) **COVER FOR GAME CONTROLLER**

(71) Applicant: **Jiarui Zhu**, Zhongshan (CN)

(72) Inventor: **Jiarui Zhu**, Zhongshan (CN)

(**) Term: **15 Years**

(21) Appl. No.: **29/754,585**

(22) Filed: **Oct. 13, 2020**

(51) **LOC (13) Cl.** **21-01**

(52) **U.S. Cl.**
USPC **D21/333**

(58) **Field of Classification Search**
USPC D21/324–29, 330, 331, 333, 341, 342, D21/349, 386, 324–329; D14/137, 138, D14/160, 168, 174, 177, 190, 217, 218, D14/250, 299, 322, 341, 345, 346, 353, D14/354, 356, 387, 388, 389, 399–401, D14/412–416, 421, 432, 440, 443, 449, D14/450, 454, 463, 471, 474, 483, 493, D14/496, 511; D22/100, 103–105; D13/162, 162.1, 168; D10/78, 98, 103; D12/174, 177, 190, 218; D18/10
CPC A45C 13/00; A45C 13/001; A45C 13/002; A63F 13/10; A63F 13/98; A63F 13/24; A63F 9/0291; A63F 13/06; A63F 13/02; A63F 9/00; A63F 9/24; A63F 11/00; G06F 3/0338; G06F 3/014; G06F 3/0346; G06F 1/1666; G06F 17/00; G06F 19/00; G06T 7/246; H04N 21/00; H04N 7/14; C09J 7/38
See application file for complete search history.

(56) **References Cited**

U.S. PATENT DOCUMENTS

D410,643 S * 6/1999 Tonino D14/401
D545,317 S * 6/2007 Wang D14/401
D712,484 S * 9/2014 Sumii D21/333
D712,973 S * 9/2014 Sumii D21/333

D718,818 S * 12/2014 Sumii D21/333
D733,802 S * 7/2015 Burgess D21/333
D806,078 S * 12/2017 Goldman D14/401
D816,083 S * 4/2018 Wu D14/401
D816,170 S * 4/2018 Chatterjee D21/333
D816,674 S * 5/2018 Wu D14/401
D816,773 S * 5/2018 Chatterjee D21/333
D819,641 S * 6/2018 Tsuchiya D14/401
D823,945 S * 7/2018 Falc D21/333
D845,395 S * 4/2019 Strahle D21/333
D856,334 S * 8/2019 Salter D14/401
D864,302 S * 10/2019 Strahle D21/333
D866,664 S * 11/2019 Strahle D21/333
D868,898 S * 12/2019 Fei D21/333
D872,183 S * 1/2020 Chatterjee D21/333

(Continued)

OTHER PUBLICATIONS

“EXtremeRated Samurai Protective Case”, posted Oct. 28, 2020 [Online], [retrieved Dec. 27, 2020]. Retrieved from Internet, <https://www.amazon.com/eXtremeRate-PlayVital-Controller-Protective-Playstation/dp/B08M36R6S2>.*

(Continued)

Primary Examiner — Sandra Snapp
Assistant Examiner — Mehri Bajoul

(57) **CLAIM**

The ornamental design for a cover for game controller, as shown and described.

DESCRIPTION

FIG. 1 is a front perspective view of a cover for game controller, showing my new design; FIG. 2 is a rear perspective view thereof; FIG. 3 is a front elevational view thereof; FIG. 4 is a rear elevational view thereof; FIG. 5 is a left side elevational view thereof; FIG. 6 is a right side elevational view thereof; FIG. 7 is a top plan view thereof; and, FIG. 8 is a bottom plan view thereof.

1 Claim, 8 Drawing Sheets

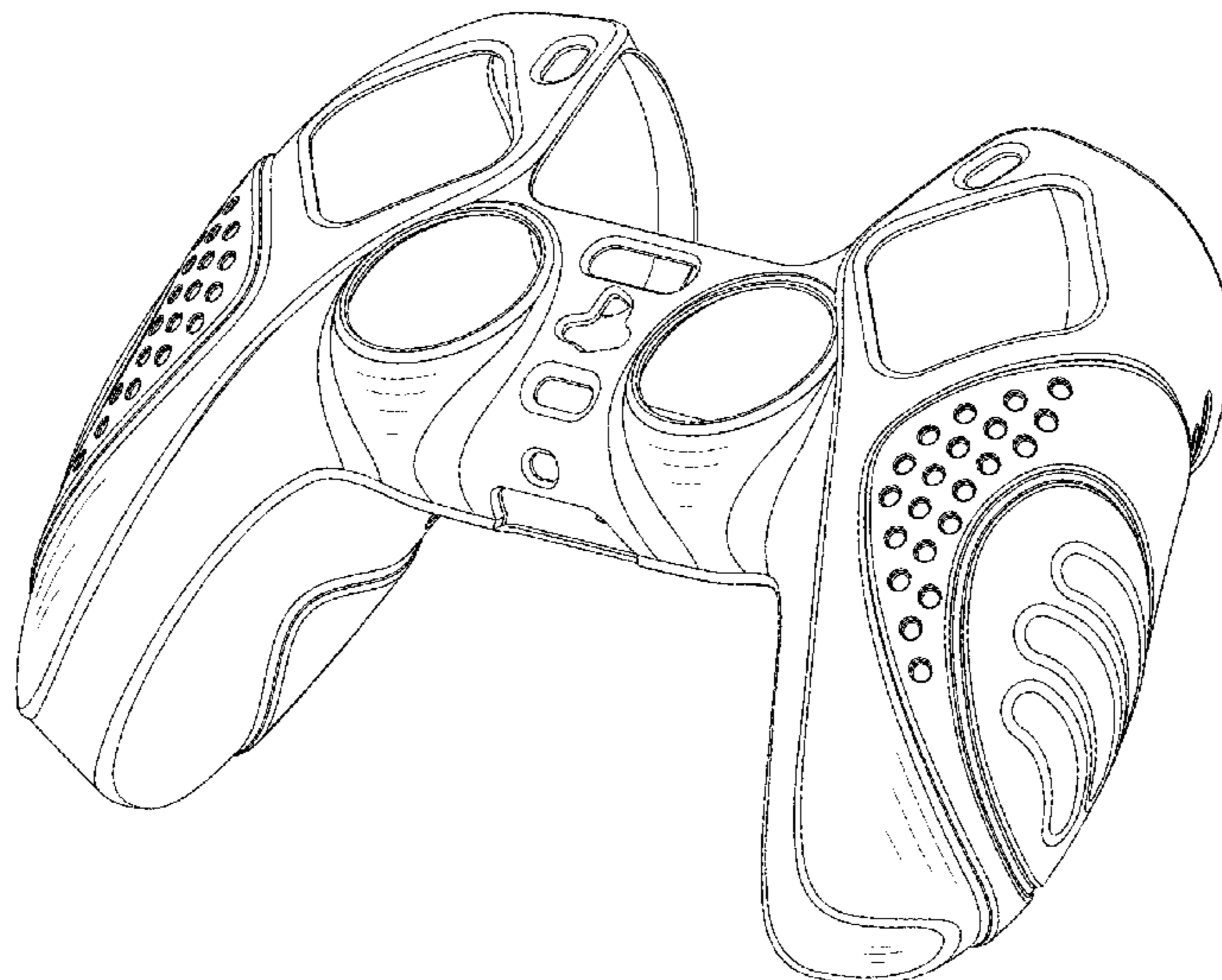

(56)

References Cited

U.S. PATENT DOCUMENTS

D882,690 S * 4/2020 Tsuchiya D21/333
2013/0130800 A1 * 5/2013 Sirilux A63F 13/31
463/37

OTHER PUBLICATIONS

“EXtremeRated Samurai Protective Case”, posted Oct. 28, 2020 [Online], [retrieved Dec. 27, 2020]. Retrieved from Internet, <https://www.amazon.com/eXtremeRate-PlayVital-Anti-Slip-Controller-Protective/dp/B08NSJSS7M>.*

“PS4 Controller Grip Skin”, posted Apr. 10, 2018 [Online], [retrieved Dec. 27, 2020]. Retrieved from Internet, https://www.amazon.com/Controller-Anti-Slip-Sony-Playstation-PlayStation-4/dp/B07C2Z1VN7/ref=psdc_6427829011_t3_B07R223DPF.*

* cited by examiner

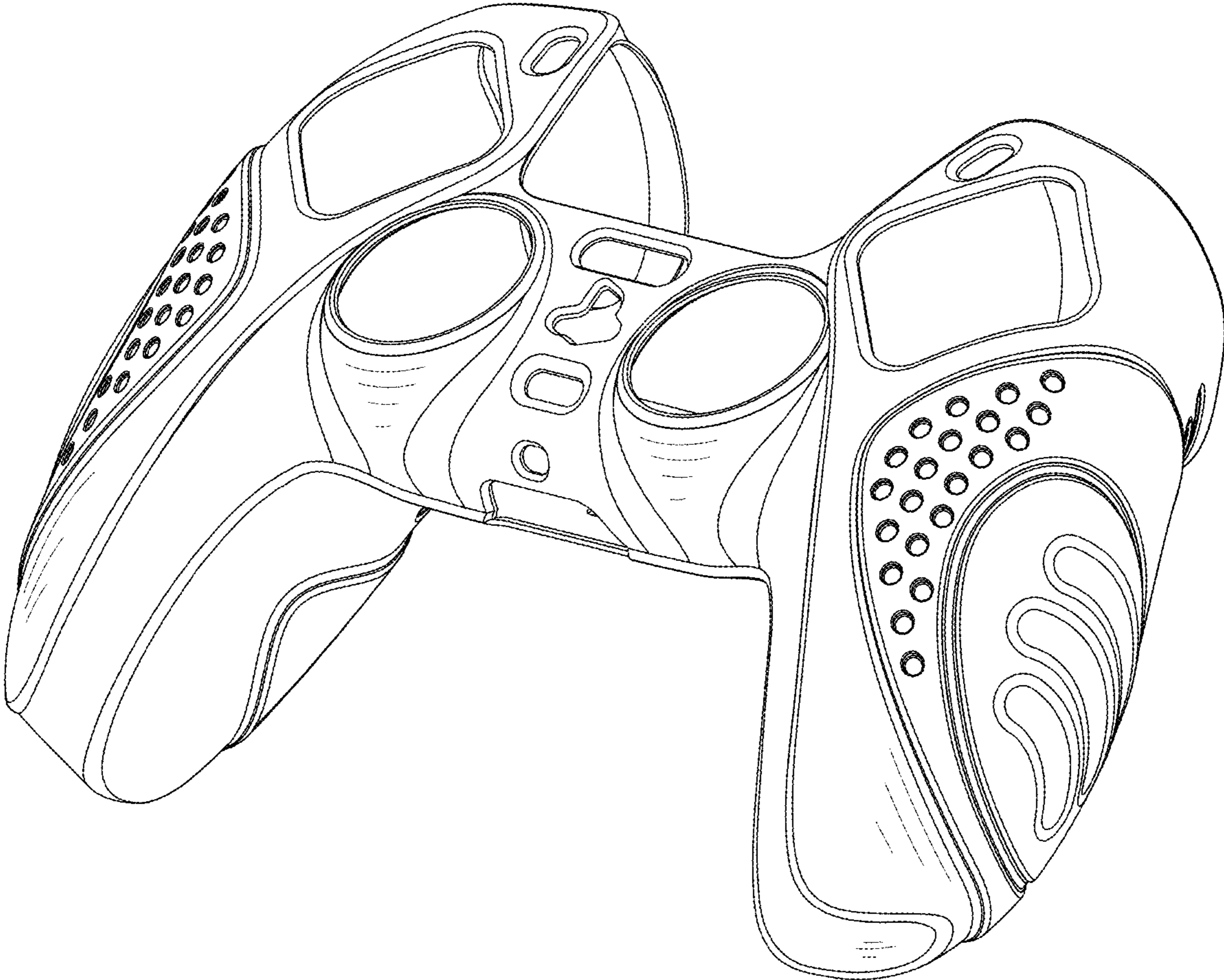

FIG. 1

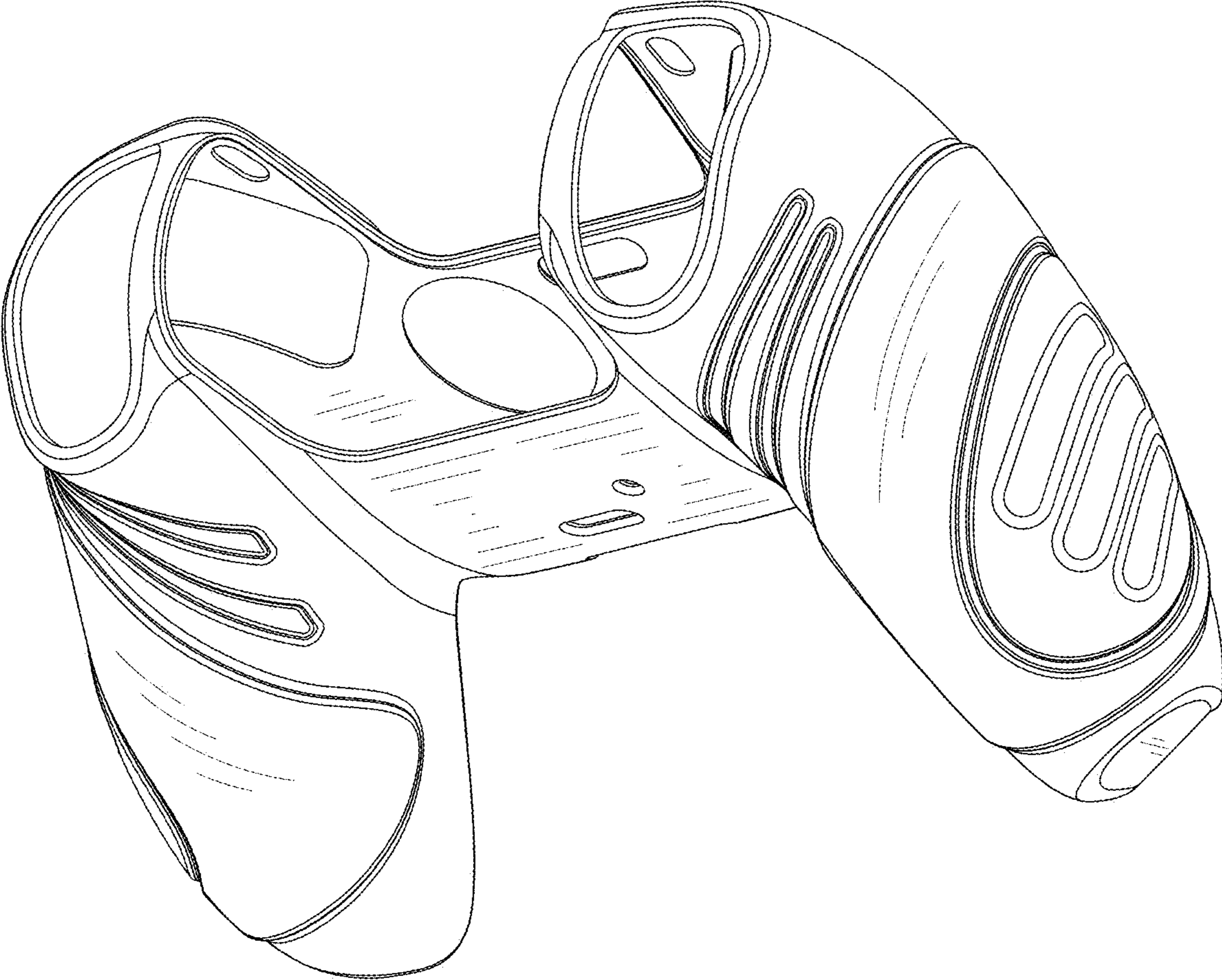

FIG. 2

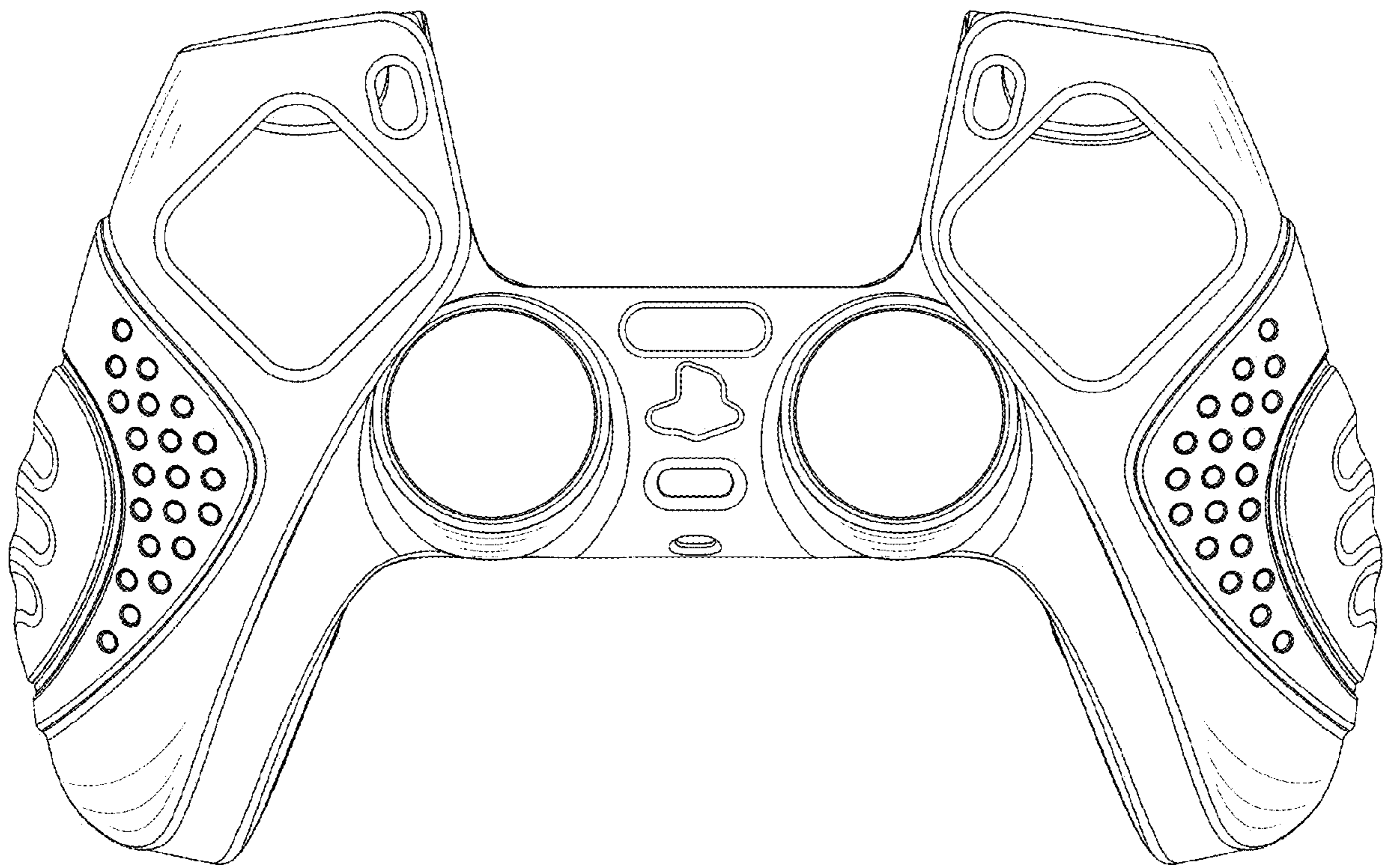

FIG. 3

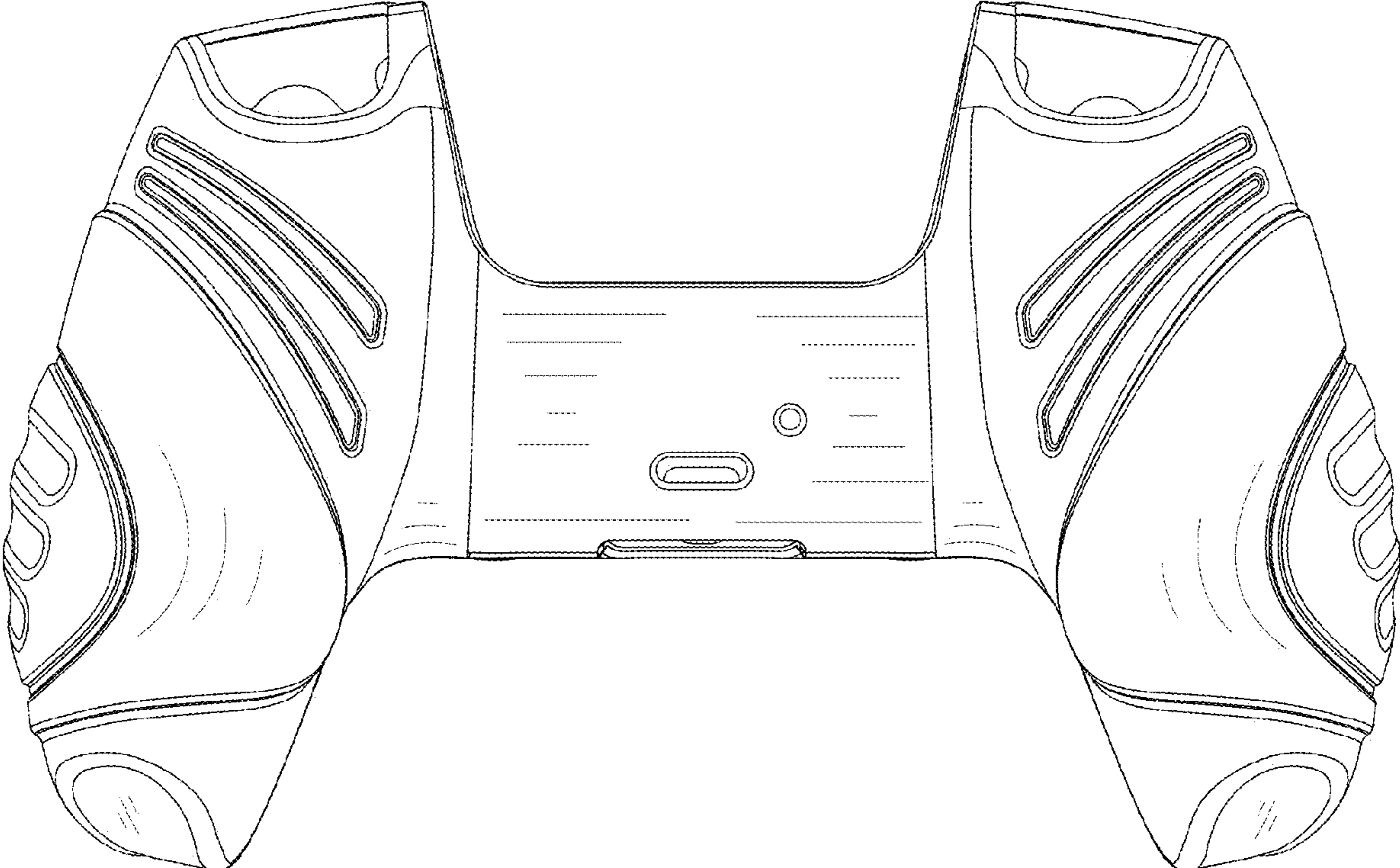

FIG. 4

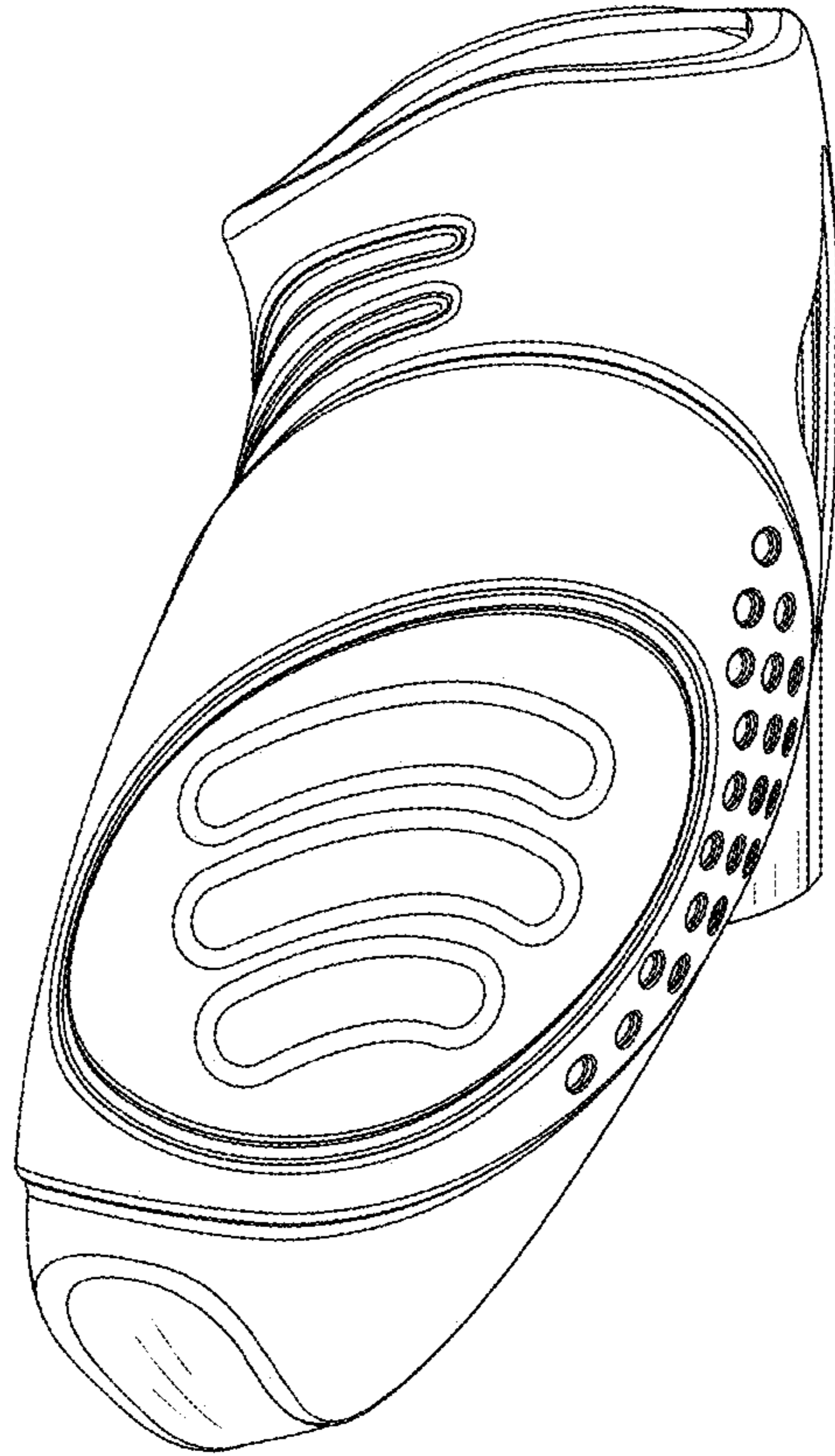

FIG. 5

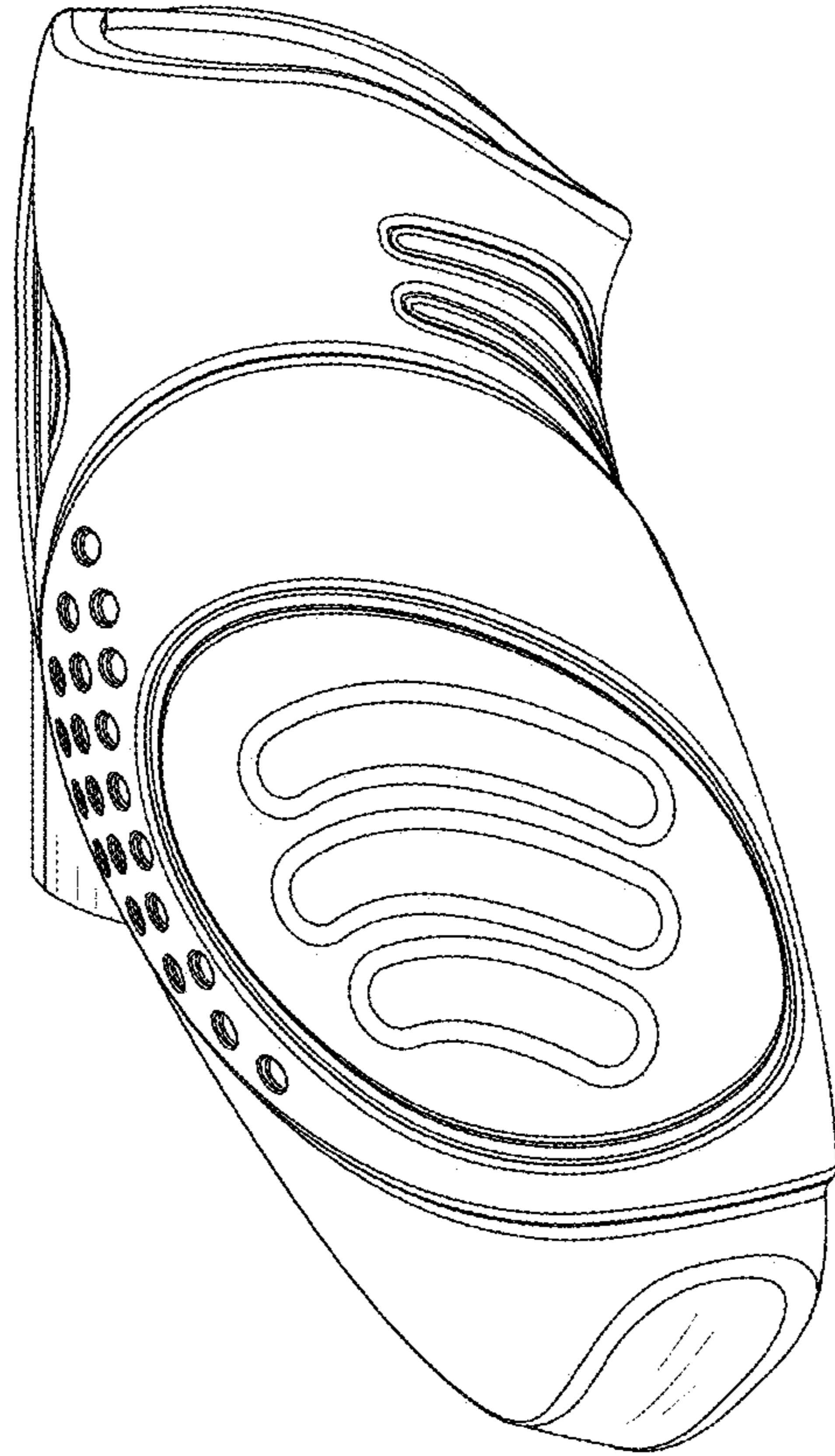

FIG. 6

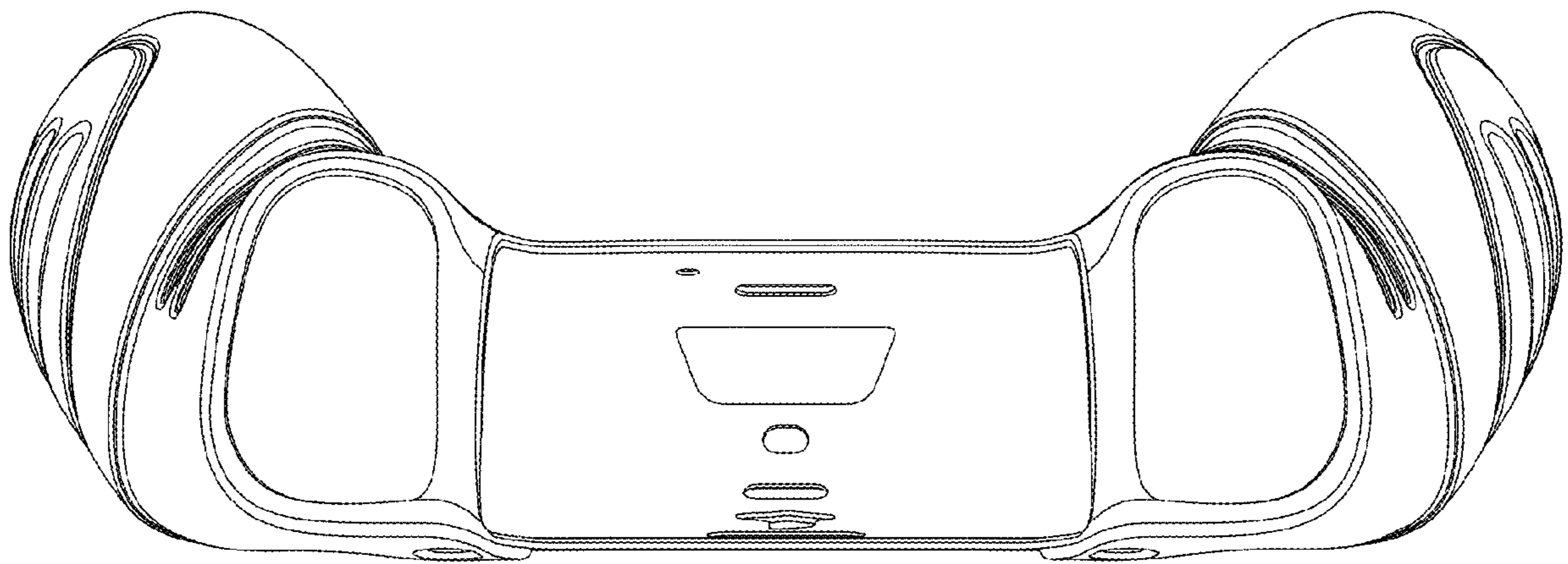

FIG. 7

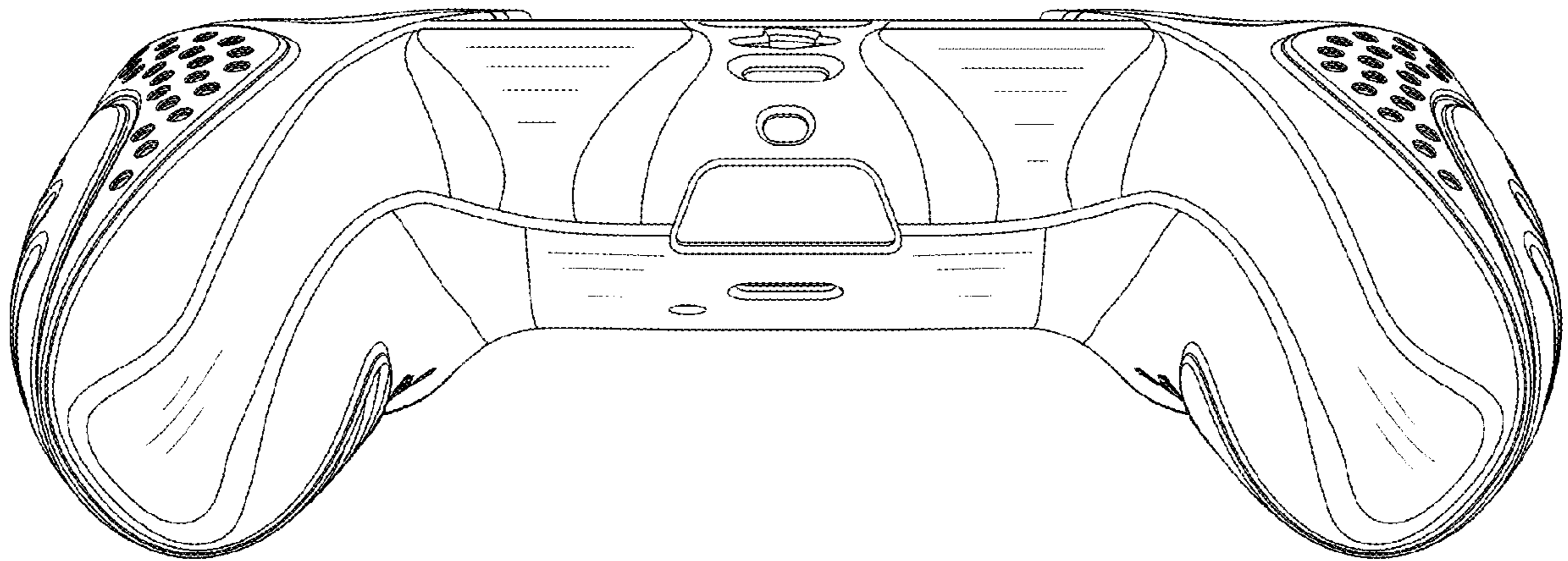

FIG. 8