



US00D936007S

(12) **United States Design Patent**
Huang et al.

(10) **Patent No.:** **US D936,007 S**

(45) **Date of Patent:** **** Nov. 16, 2021**

(54) **ENERGY STORAGE AND POWER SUPPLY DEVICE**

(71) Applicant: **3A TECHNOLOGY CO., LIMITED**,
Shenzhen (CN)

(72) Inventors: **Shisheng Huang**, Shenzhen (CN);
Yongxing Wang, Shenzhen (CN);
Baiguang Zhang, Shenzhen (CN)

(**) Term: **15 Years**

(21) Appl. No.: **29/779,535**

(22) Filed: **Apr. 20, 2021**

(51) **LOC (13) Cl.** **13-02**

(52) **U.S. Cl.**
USPC **D13/110**

(58) **Field of Classification Search**

USPC D13/101, 102, 103, 107, 108, 110, 118,
D13/119, 123, 184, 199; D14/251, 253,
D14/432, 434

CPC .. H02J 7/00; H02J 7/027; H02J 7/0042; H02J
7/0045; H02J 7/0047; H02J 7/0063; H02J
7/32; H02J 7/342; H02J 7/1423; H02M
7/00; H02M 7/003; H01M 2/202; H01M
2/204; H01M 2/1022; H01M 2/342;
H05K 5/0247; Y02T 10/7005; Y02T
10/705; Y02T 10/7088; F21L 4/00

See application file for complete search history.

(56) **References Cited**

U.S. PATENT DOCUMENTS

D377,335 S * 1/1997 Katooka D13/110
D624,876 S * 10/2010 Daniels D13/107

D718,237 S 11/2014 Asakura et al.
D773,992 S 12/2016 Krantz et al.
D823,797 S 7/2018 Krantz et al.
D883,206 S * 5/2020 Bai D13/110
2001/0043052 A1* 11/2001 Griffey H02M 7/003
320/114
2012/0025766 A1* 2/2012 Reade H05K 5/023
320/110

* cited by examiner

Primary Examiner — Derrick E Holland

(57) **CLAIM**

The ornamental design for an energy storage and power supply device, as shown and described.

DESCRIPTION

FIG. 1 is a first perspective view of an energy storage and power supply device showing my new design;
FIG. 2 is a second perspective view thereof;
FIG. 3 is a front view thereof;
FIG. 4 is a back view thereof;
FIG. 5 is a left side view thereof;
FIG. 6 is a right side view thereof;
FIG. 7 is a top view thereof; and,
FIG. 8 is a bottom view thereof.

The broken lines shown in the drawings depict portions of the energy storage and power supply device in which the design is embodied that form no part of the claimed design.

1 Claim, 8 Drawing Sheets

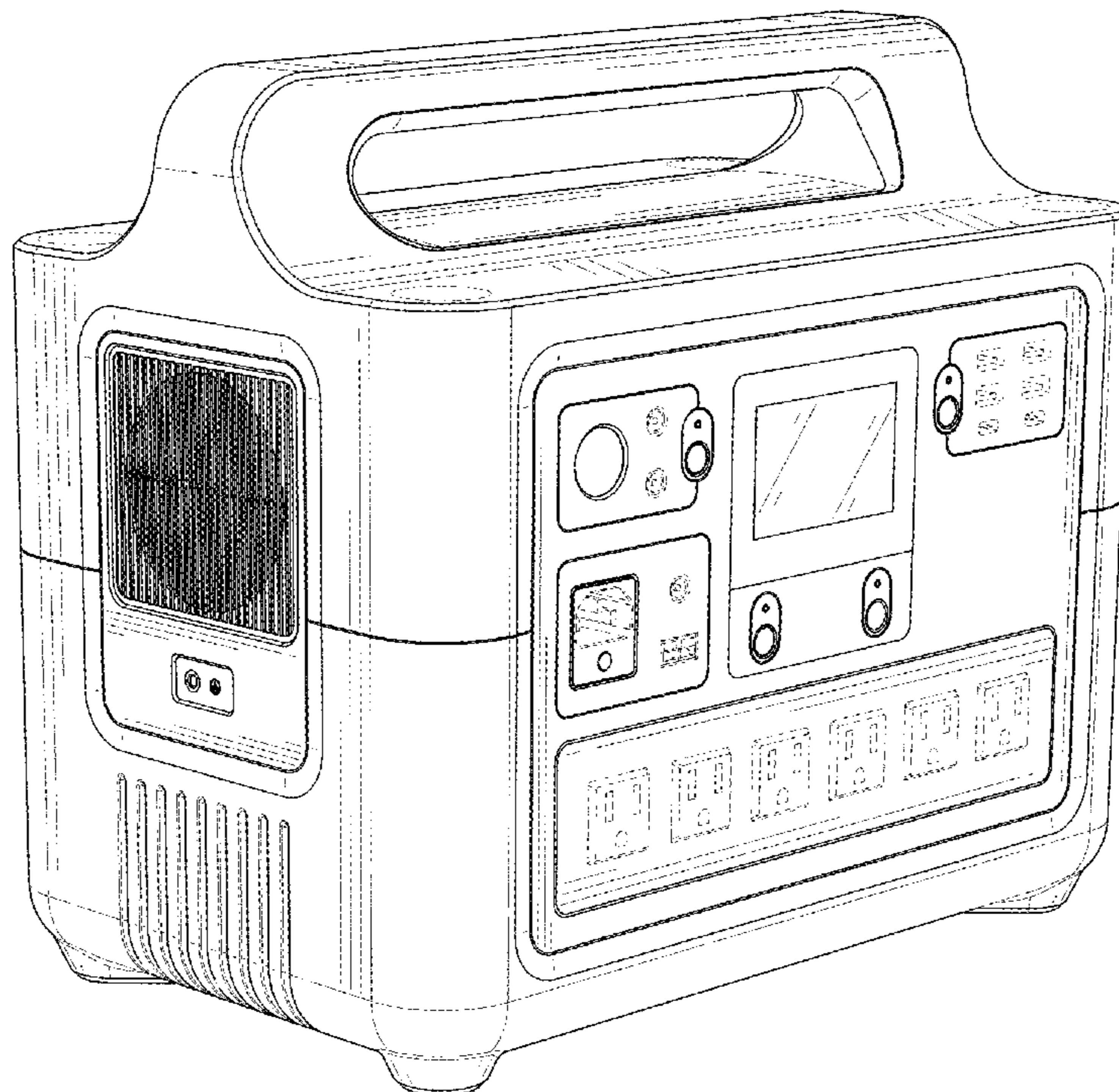

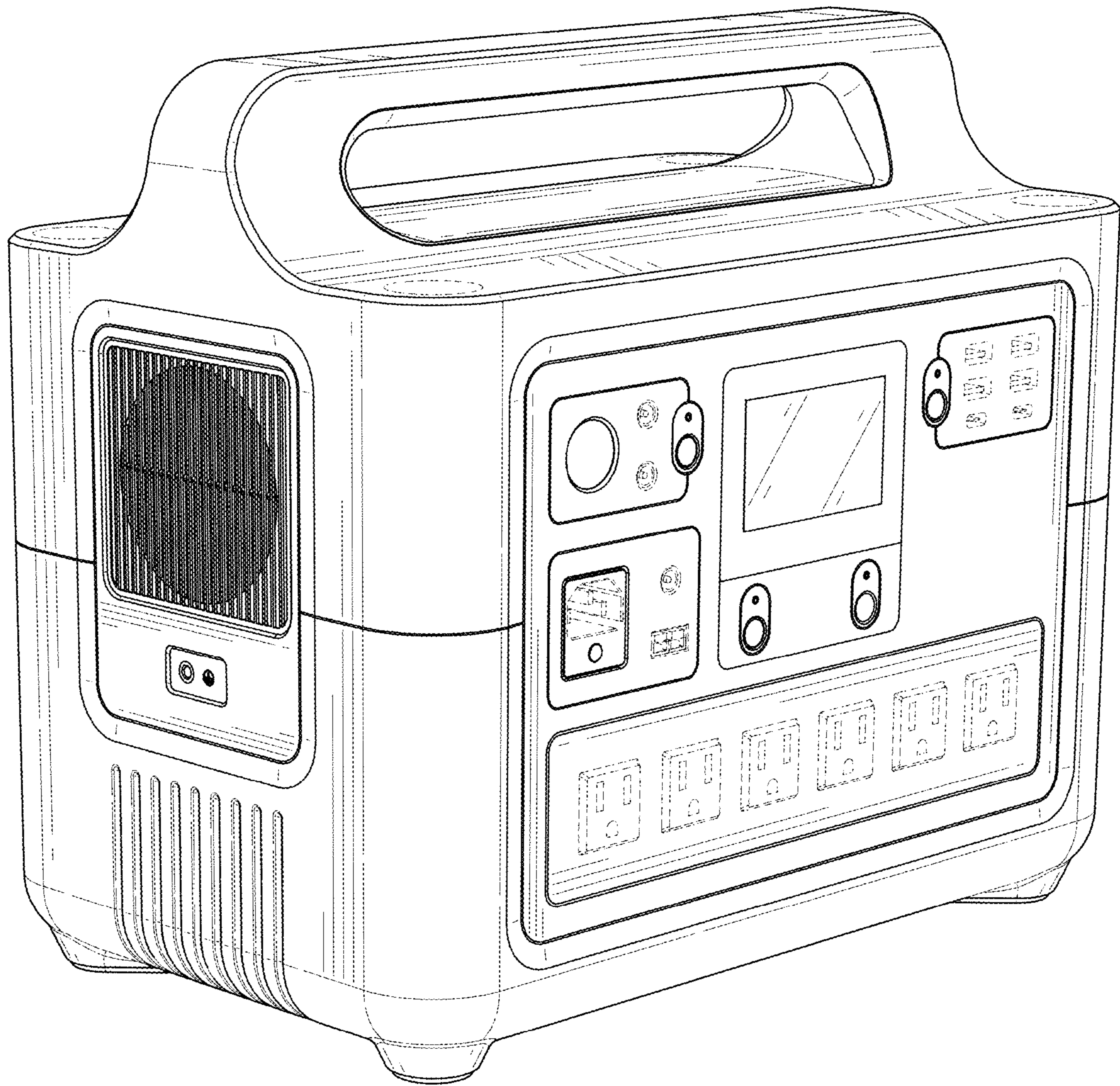

FIG. 1

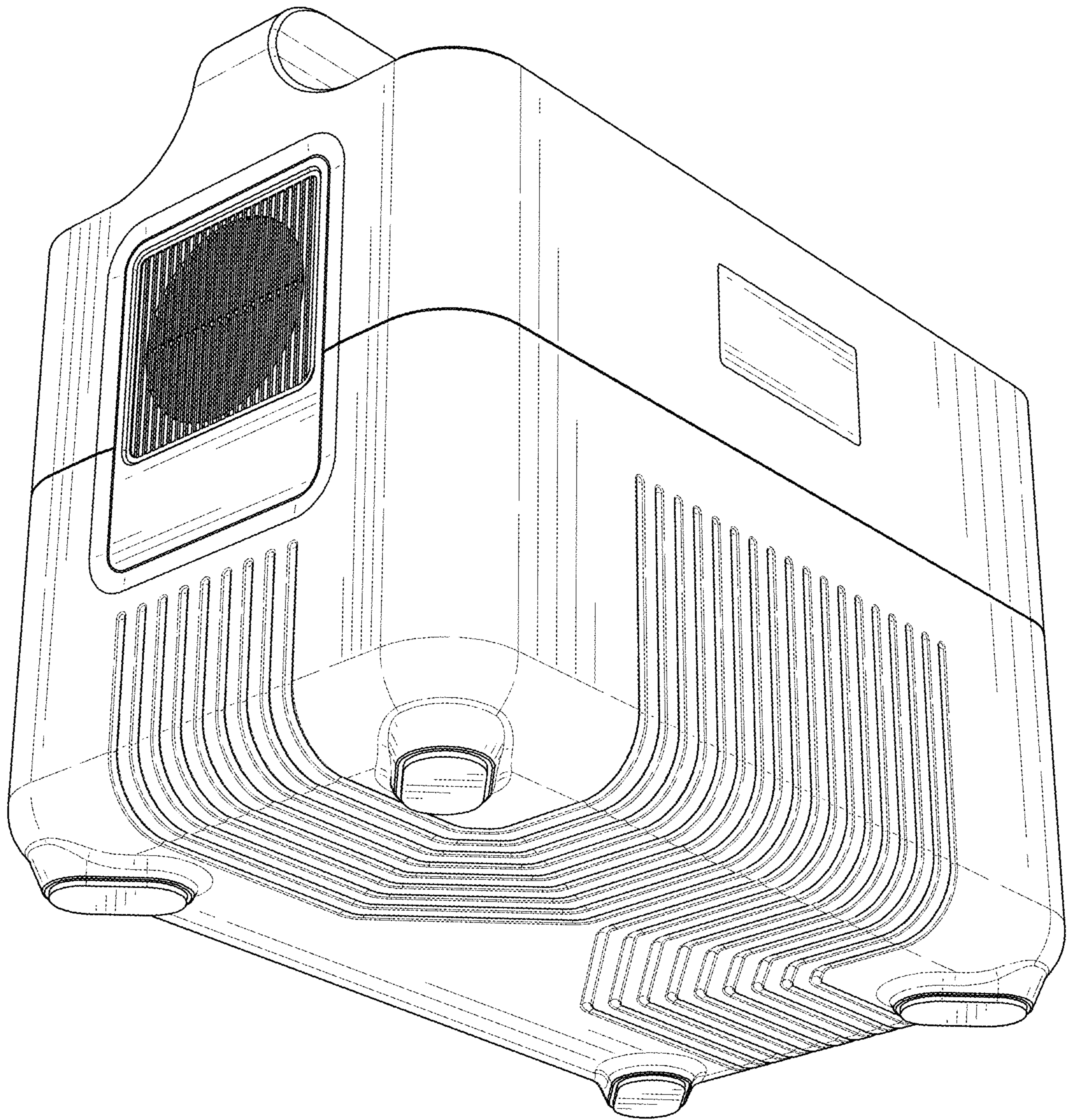

FIG. 2

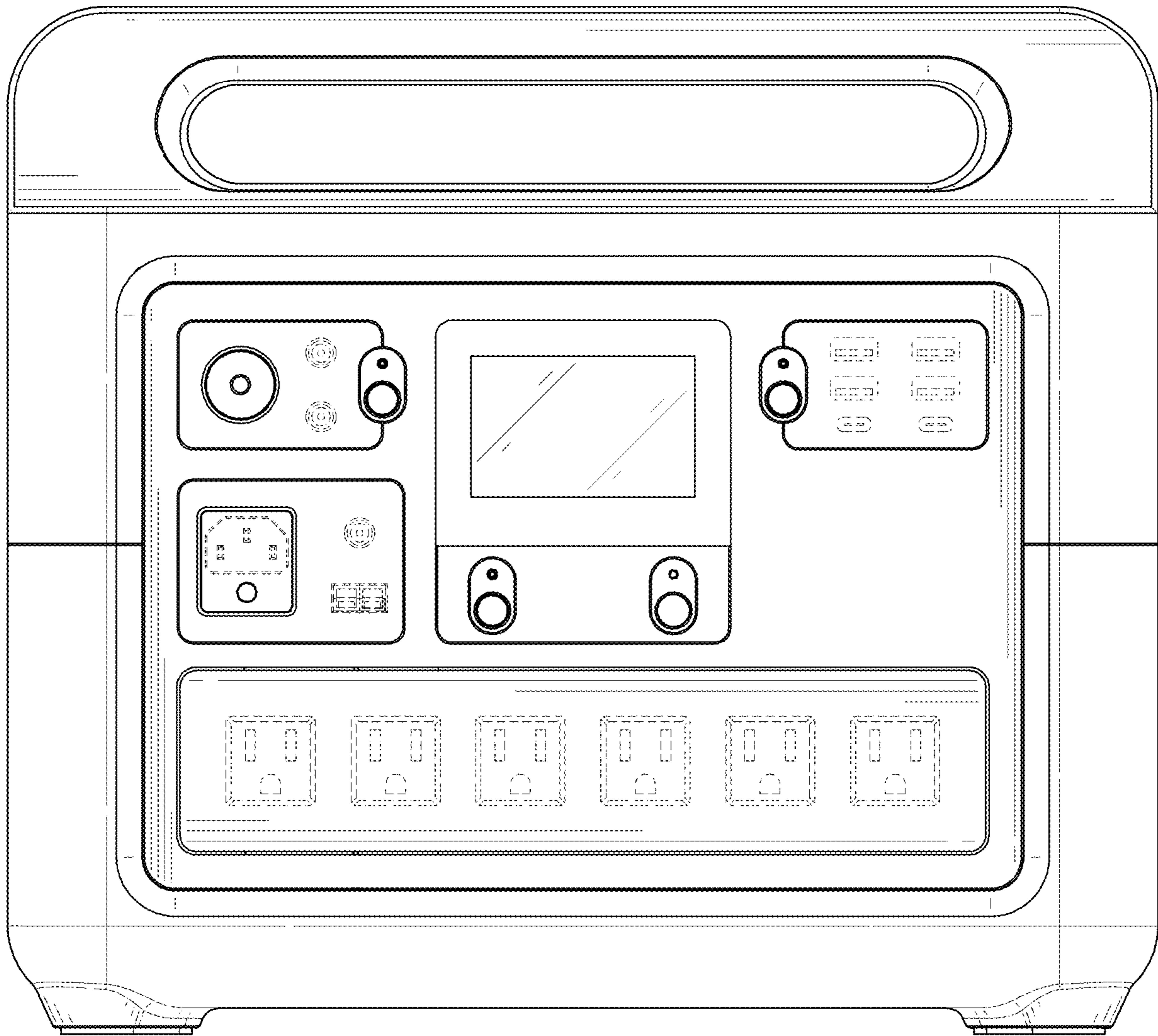

FIG. 3

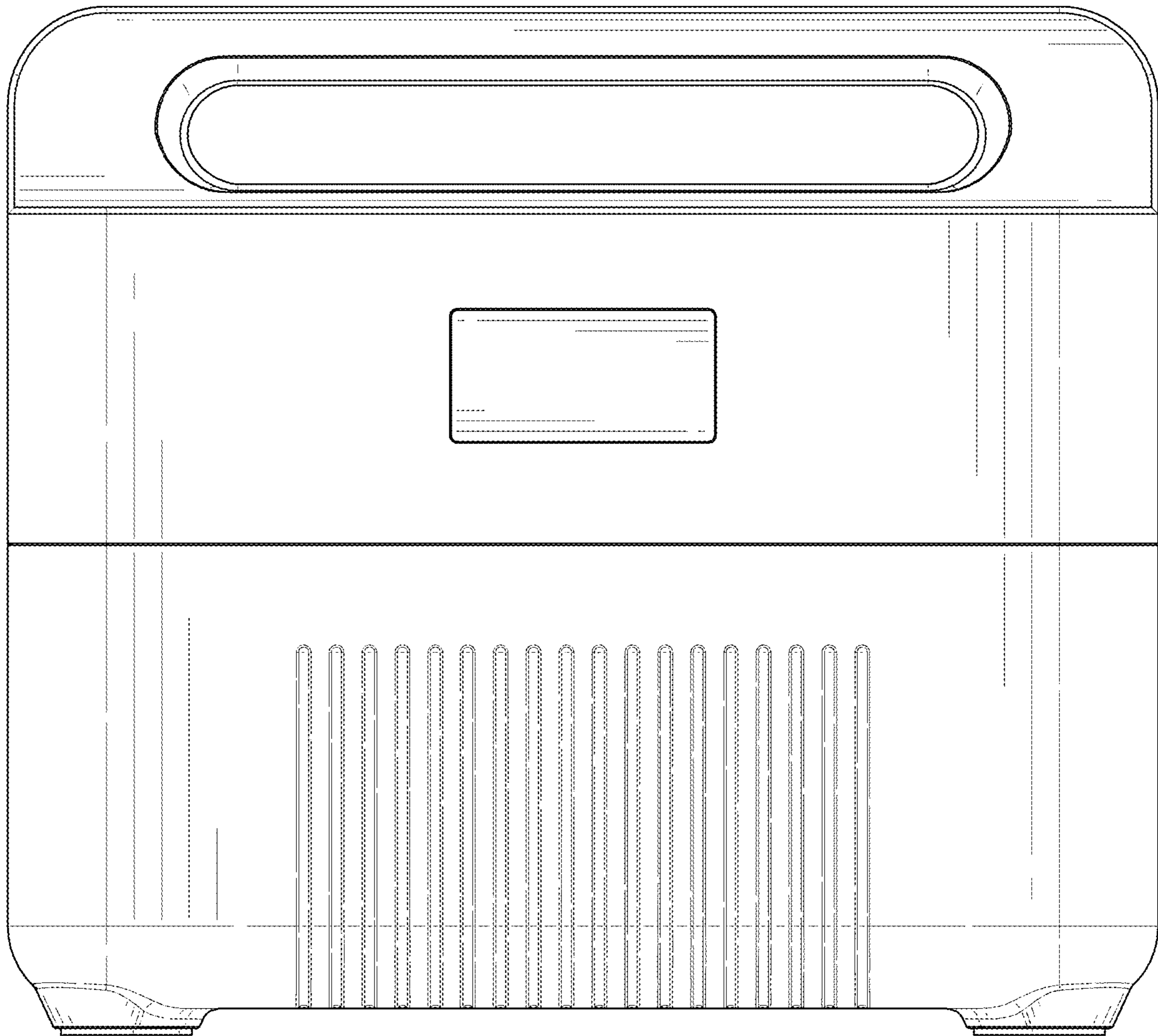

FIG. 4

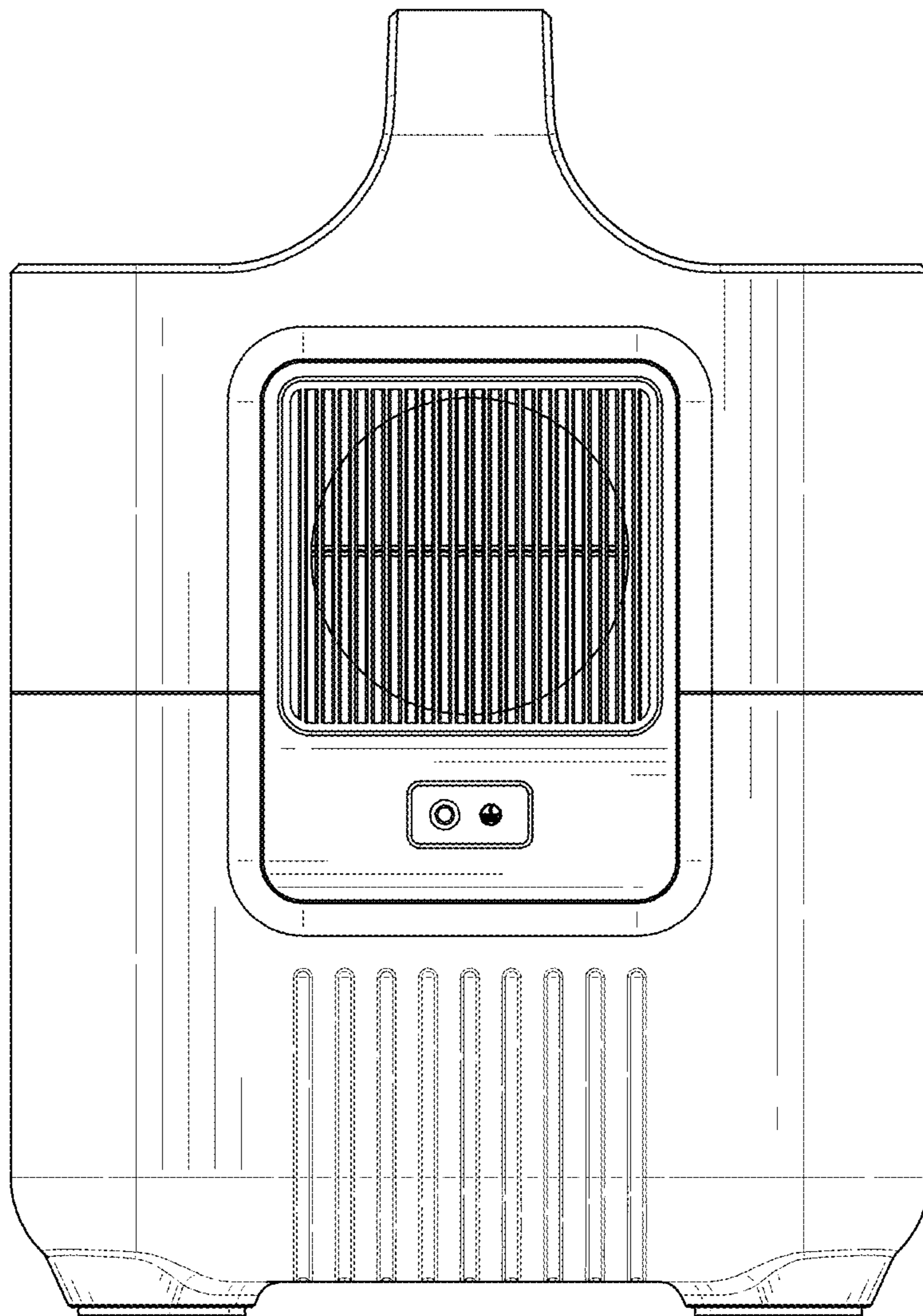

FIG. 5

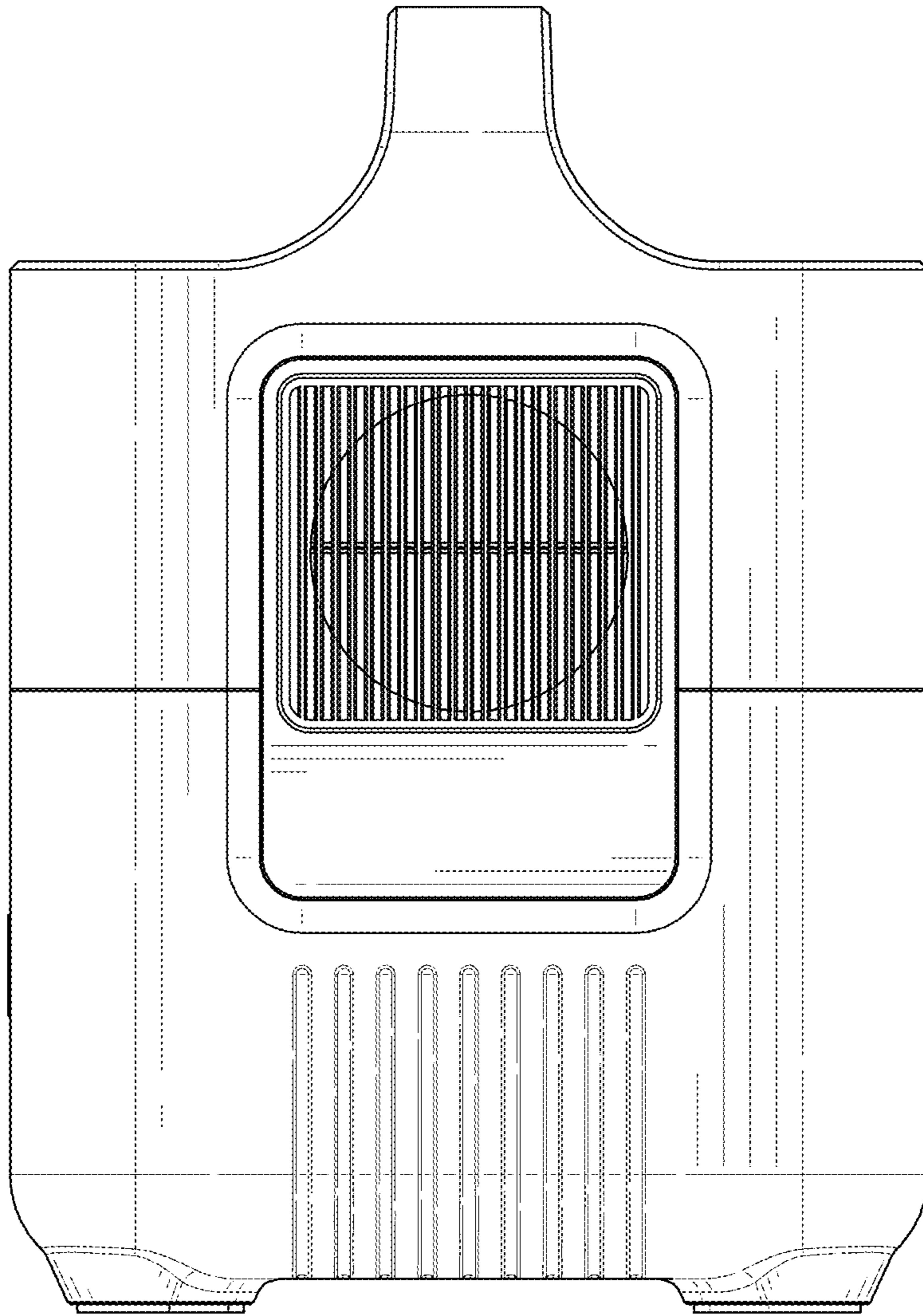

FIG. 6

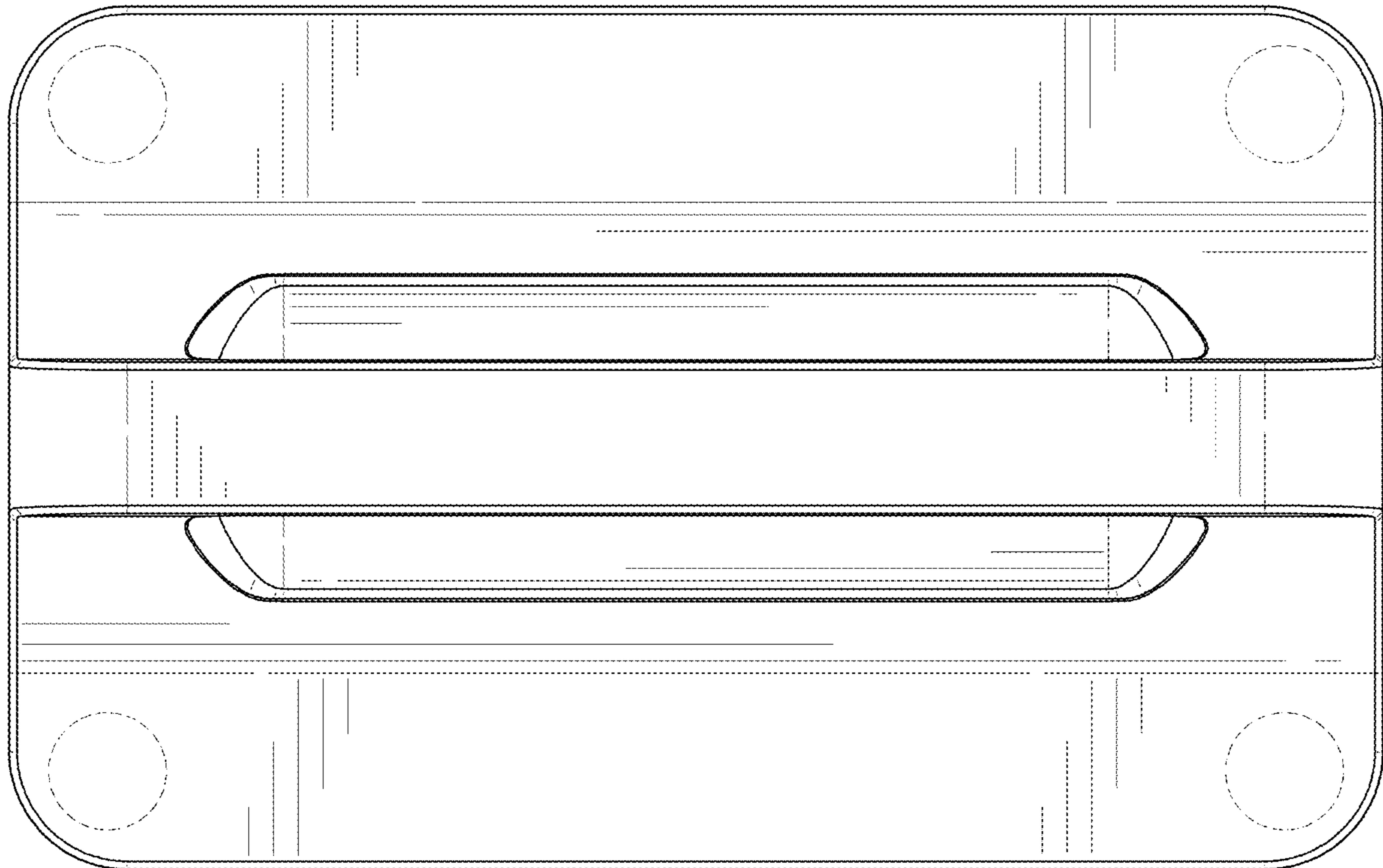

FIG. 7

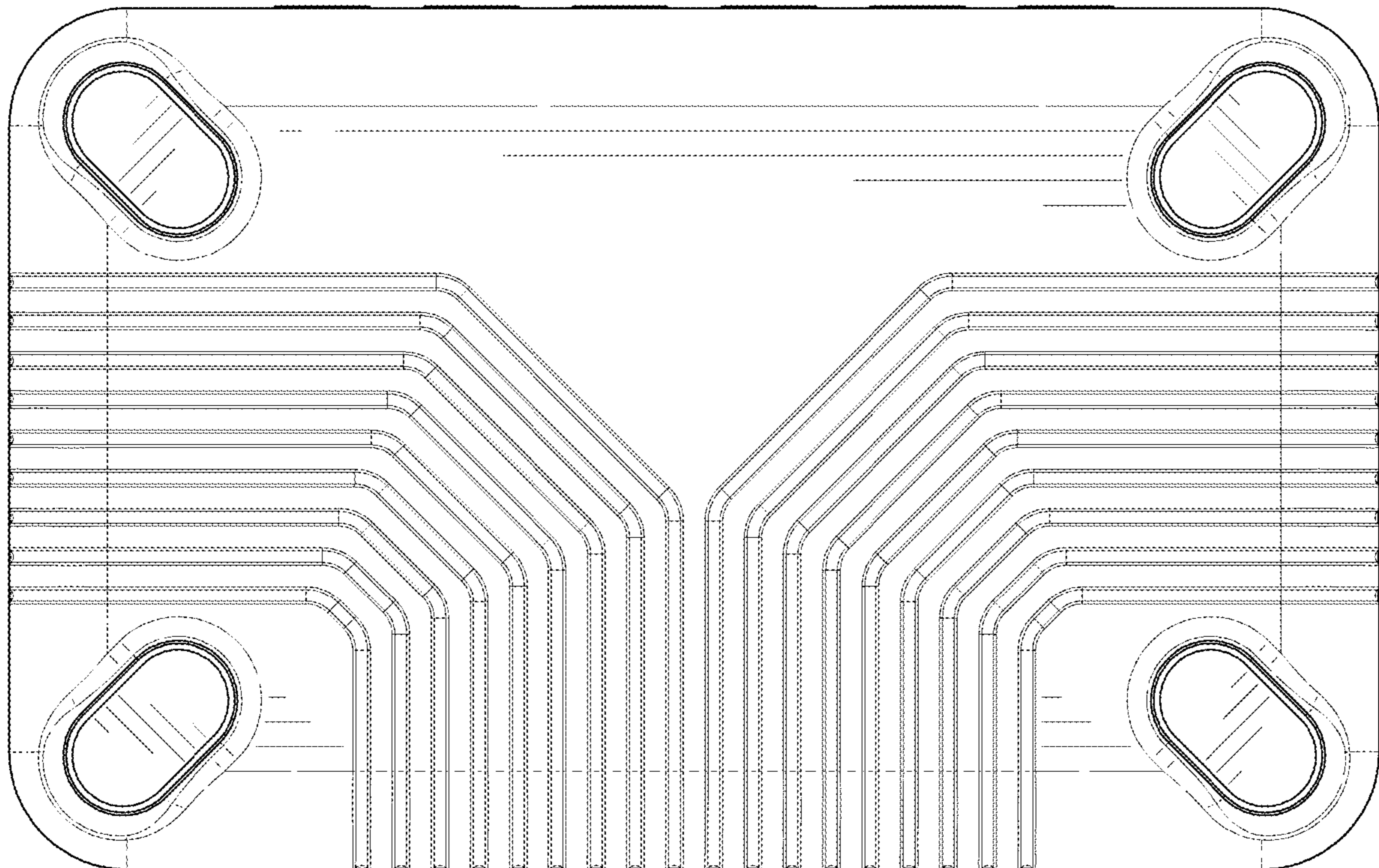

FIG. 8