



US00D935843S

(12) **United States Design Patent** (10) **Patent No.:** **US D935,843 S**
Lewis (45) **Date of Patent:** **** Nov. 16, 2021**

(54) **EXTRUDER PLATE FOR FOOD PROCESSING**

(71) Applicant: **FN Acquisitions Limited**, Petersfield (GB)

(72) Inventor: **Stephen Lewis**, Petersfield (GB)

(73) Assignee: **FN Acquisitions Limited**, Petersfield (GB)

(**) Term: **15 Years**

(21) Appl. No.: **29/702,731**

(22) Filed: **Aug. 21, 2019**

(30) **Foreign Application Priority Data**

Apr. 10, 2019 (EM) 006374799-0001
 Apr. 10, 2019 (EM) 006374799-0002

(51) **LOC (13) Cl.** **31-00**

(52) **U.S. Cl.**
USPC **D7/412**; D7/378; D7/391

(58) **Field of Classification Search**

USPC D7/354, 358, 372, 376–386, 392.1,
 D7/412–414, 602, 629, 665–666, 669,
 D7/679, 693–694; D9/435, 447
 CPC A21C 1/02; A21C 1/04; A23N 1/00; A23N
 1/02; A47G 23/0216; A47J 43/04; A47J
 43/25; A47J 43/27; A47J 43/042; A47J
 43/044; A47J 43/046; A47J 43/075; A47J
 43/0716; A47J 43/0722; A47J 43/0727;
 B01F 3/00; B01F 3/0807; B01F 3/0853;
 B01F 13/0059; B01F 13/0064; B02C
 1/08; B02C 2/04; B02C 4/42; B02C
 4/142; B02C 4/143; B02C 4/423; B02C
 13/1835; B65D 43/0212; B28C 5/10;
 B28C 5/12; B28C 5/14; B28C 5/16

See application file for complete search history.

(56) **References Cited**

U.S. PATENT DOCUMENTS

D631,348 S *	1/2011	Weiss	D9/447
D659,470 S *	5/2012	Narwankar	D7/414
D753,999 S *	4/2016	Crosby	D9/447
D754,535 S *	4/2016	Kim	D9/435
D806,469 S *	1/2018	Palmer	B65D 41/005
			D7/392.1
2015/0201777 A1 *	7/2015	Kim	A47G 23/0216
			220/713
2016/0198875 A1 *	7/2016	Mithal	B65D 43/0212
			220/713

* cited by examiner

Primary Examiner — Ricky Pham

(74) *Attorney, Agent, or Firm* — EIP US LLP

(57) **CLAIM**

I claim the ornamental design for a extruder plate for food processing, as shown and described.

DESCRIPTION

FIG. 1 is a perspective view showing our new ornamental design for a extruder plate for food processing.

FIG. 2 is a front view thereof;

FIG. 3 is a rear view thereof;

FIG. 4 is a left side view thereof;

FIG. 5 is a right side view thereof;

FIG. 6 is a top view thereof; and,

FIG. 7 is a bottom view thereof.

Dashed or otherwise broken lines are used for illustrative purposes only to give environmental context to the claimed design and do not form any part of the claimed design.

1 Claim, 5 Drawing Sheets

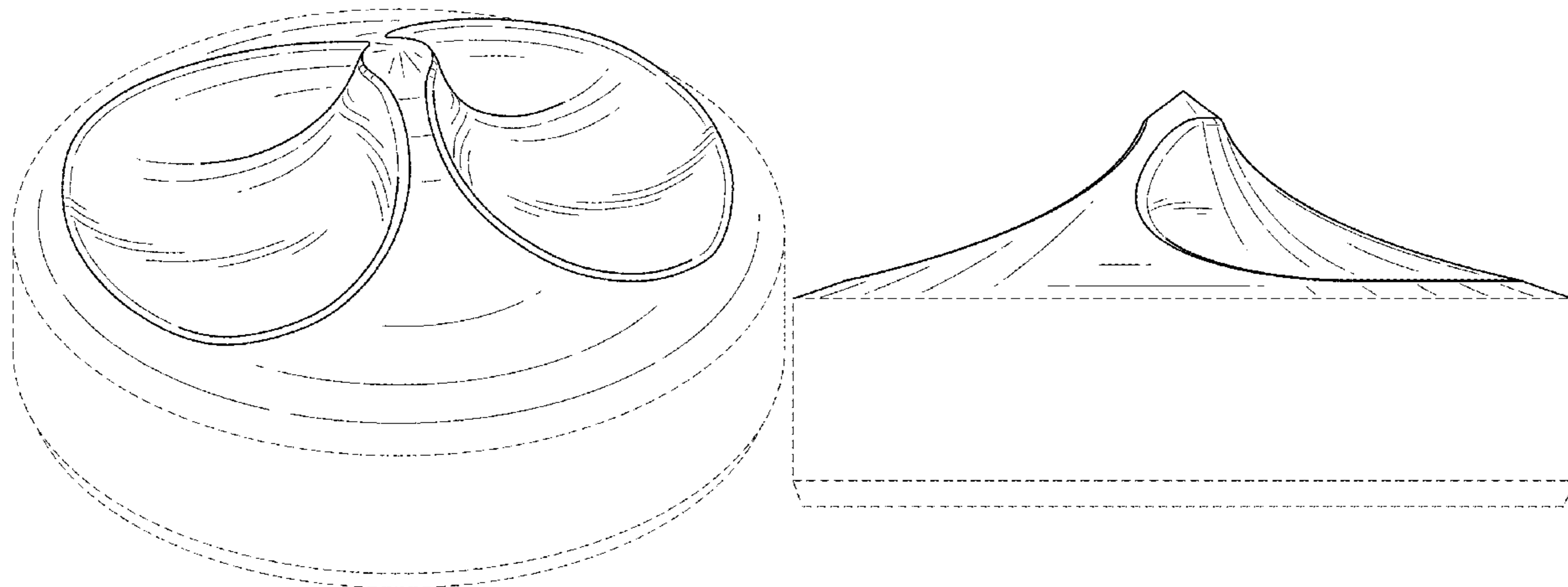

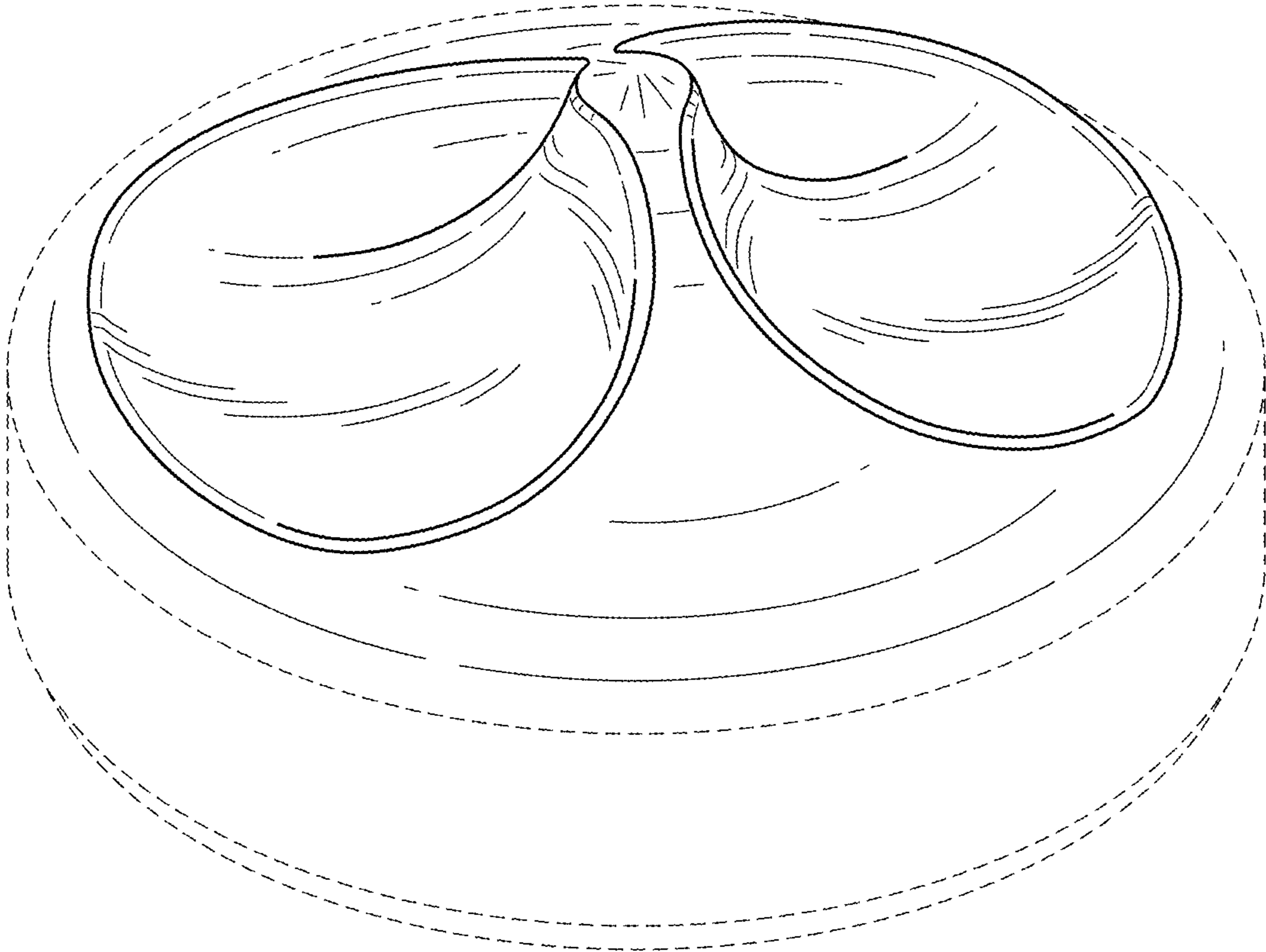

FIG. 1

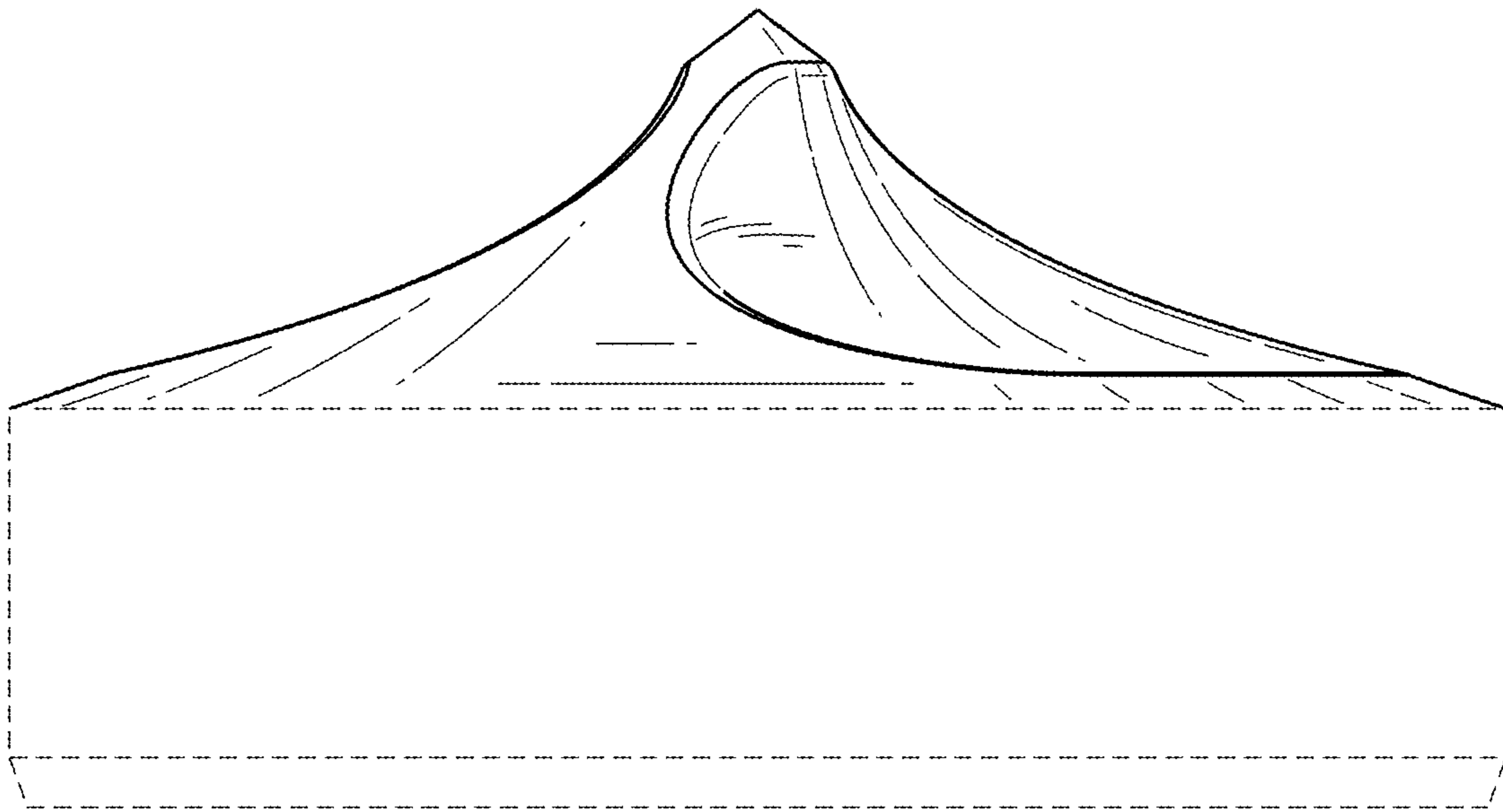

FIG. 2

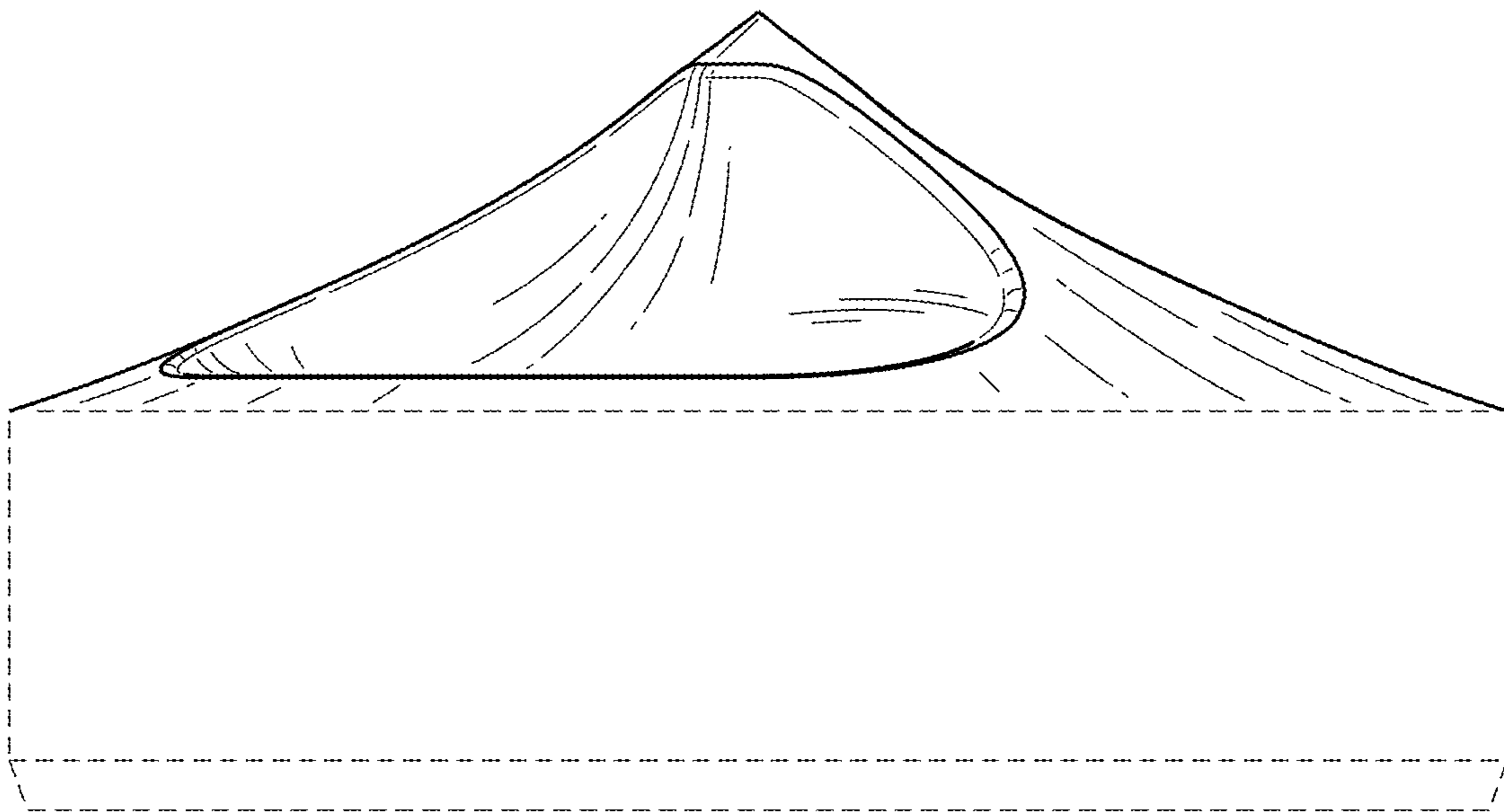

FIG. 3

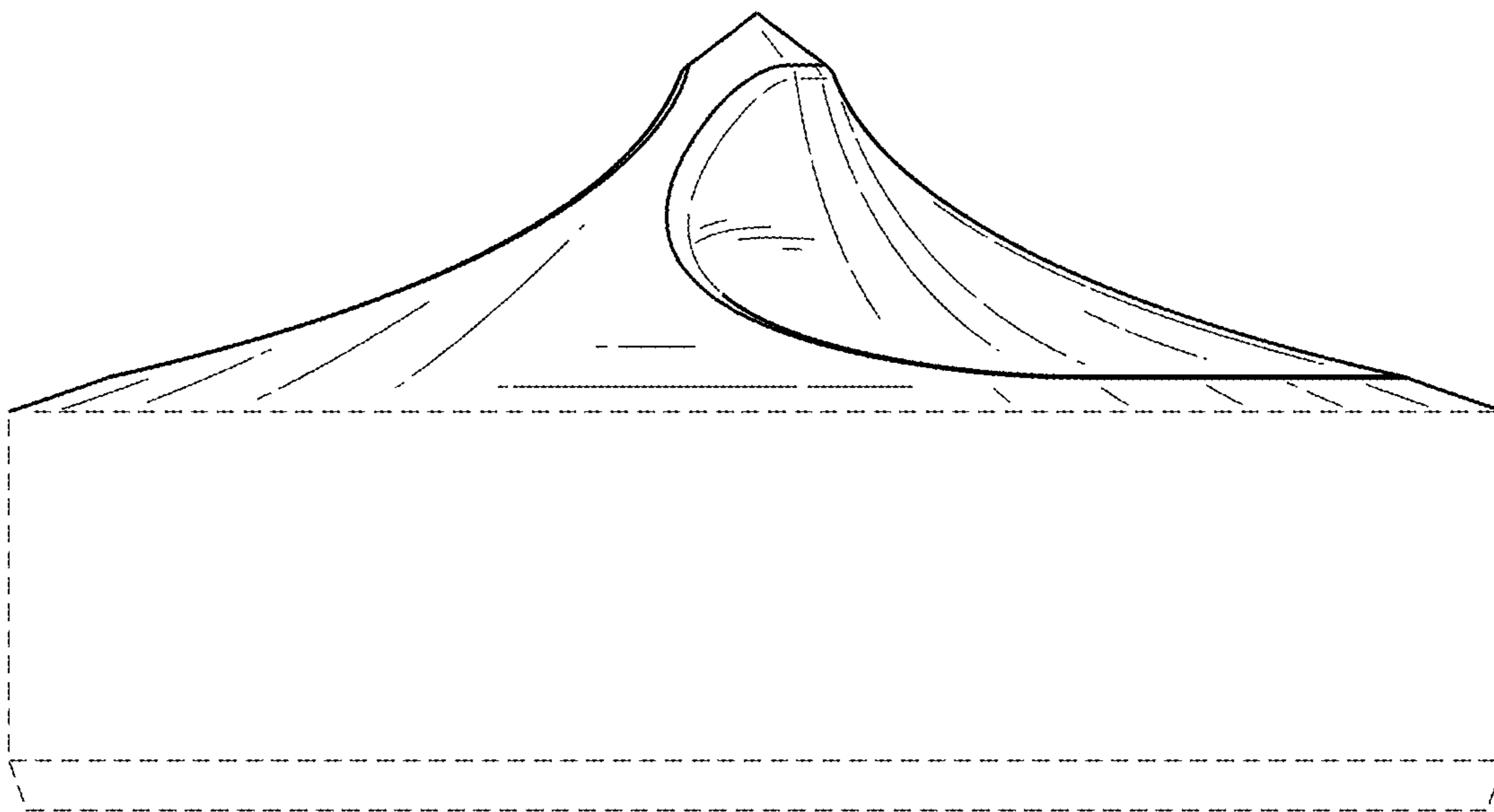

FIG. 4

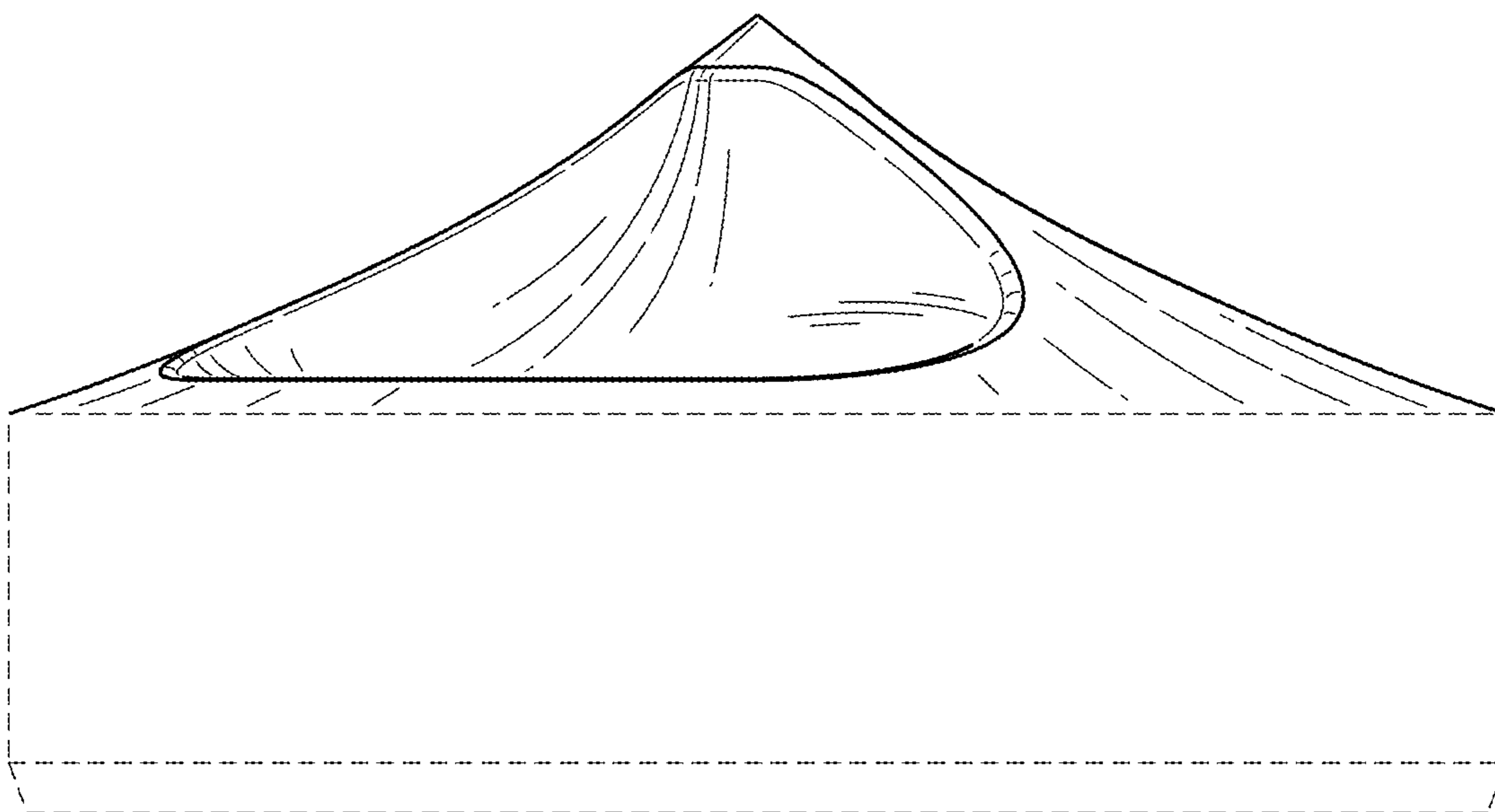

FIG. 5

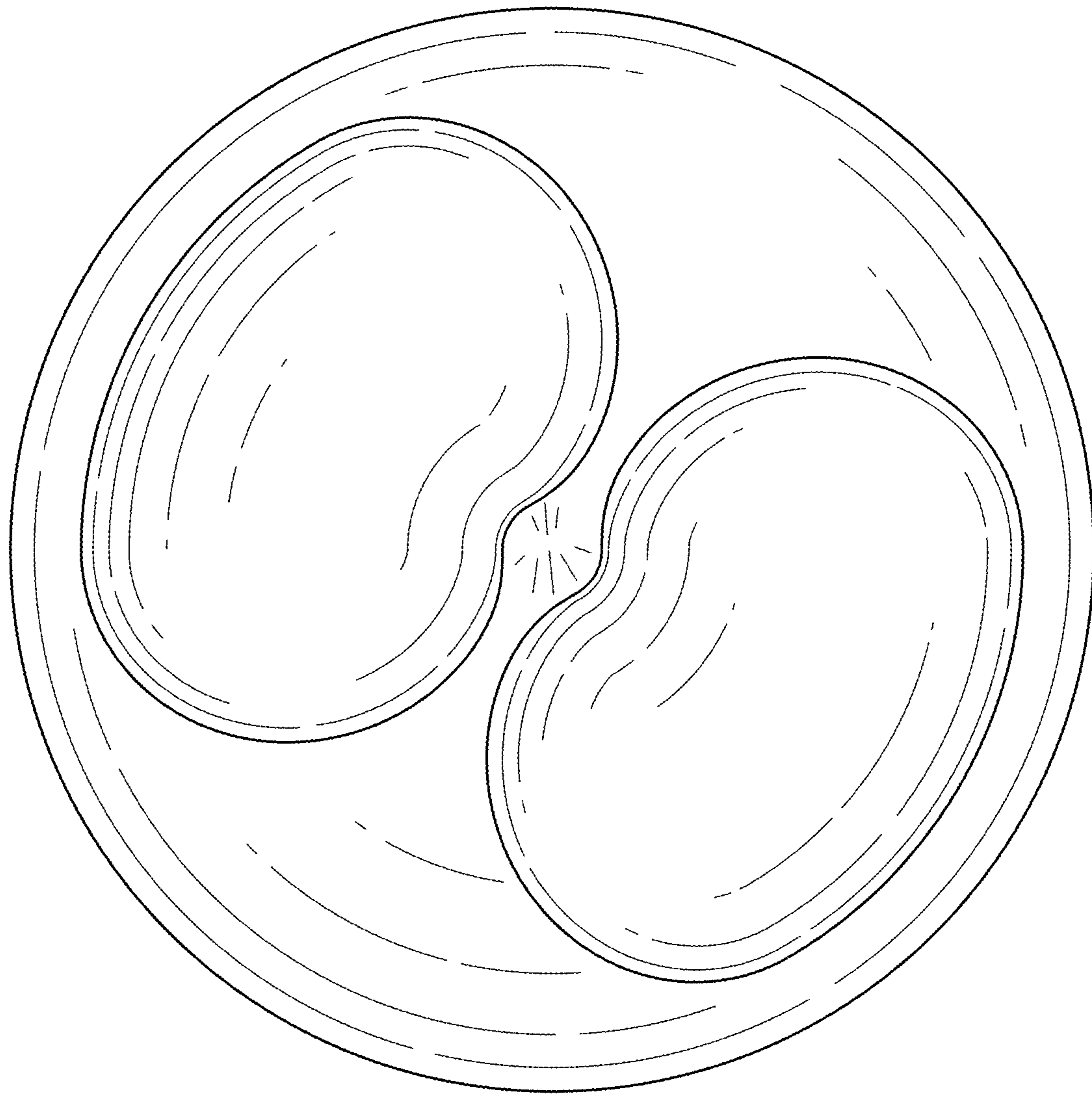

FIG. 6

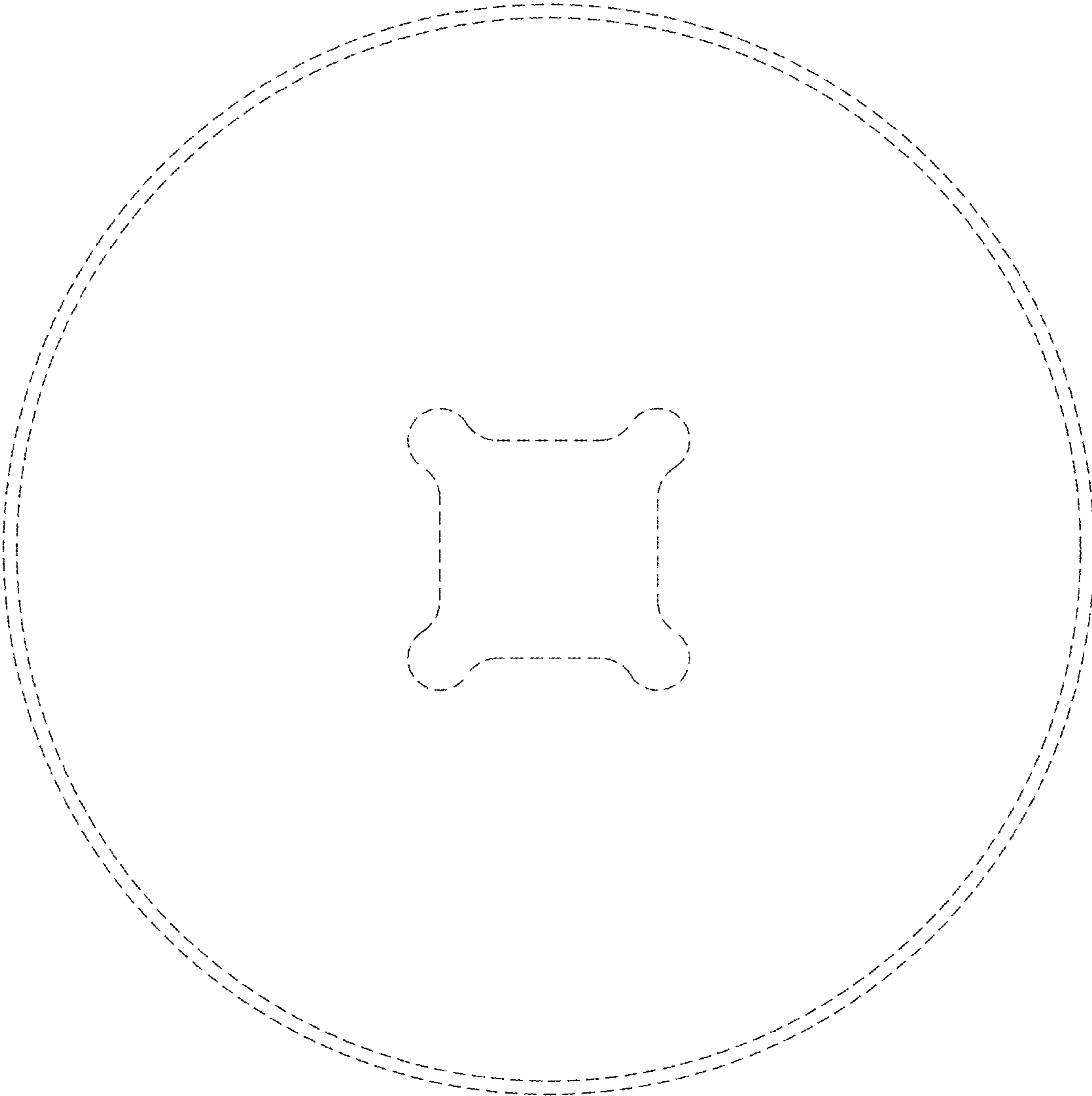

FIG. 7