



US00D935830S

(12) **United States Design Patent**  
**Jewett**

(10) **Patent No.:** **US D935,830 S**

(45) **Date of Patent:** **\*\* \*Nov. 16, 2021**

- (54) **BAKING PAN**
- (71) Applicant: **MJ Angel Food Bakery L.L.C.**,  
Centerville, UT (US)
- (72) Inventor: **Marcy Lynn Jewett**, Centerville, UT  
(US)
- (73) Assignee: **MJ Angel Food Bakery L.L.C.**,  
Centerville, UT (US)
- (\*) Notice: This patent is subject to a terminal disclaimer.
- (\*\*) Term: **15 Years**
- (21) Appl. No.: **29/712,609**
- (22) Filed: **Nov. 8, 2019**
- (51) **LOC (13) Cl.** ..... **07-02**
- (52) **U.S. Cl.**  
USPC ..... **D7/354**
- (58) **Field of Classification Search**  
USPC ..... D7/323, 337, 339, 340, 341, 352, 354,  
D7/355, 356, 357, 358, 359, 360, 361,  
D7/393, 402, 403, 409, 601, 612; D34/1,  
D34/3; D9/519, 738  
CPC .... A21B 1/06; A21B 1/26; A21B 1/50; A21B  
1/52; A47J 37/04; A47J 37/06; A47J  
37/015; A47J 37/067; A47J 37/0629;  
A47J 37/0676; A47J 37/108; A47J 36/16;  
A47J 36/20; A47J 36/22; F24C 7/06;  
F24C 15/02; H05B 3/20; H05B 3/40  
See application file for complete search history.

D322,753 S *	12/1991	Sussman .....	D9/504
D333,758 S	3/1993	Lillelund	
D335,729 S	5/1993	Brussing	
D350,875 S	9/1994	VanValkenburg	
D358,531 S	5/1995	Cousins	
D368,828 S	4/1996	Thurlow	
D369,505 S	5/1996	Philippe	
D378,976 S	4/1997	Joergensen	
D433,274 S	11/2000	Babayan	
D446,686 S	8/2001	Holthus	
D470,724 S *	2/2003	Basara .....	D7/603
6,732,880 B1	5/2004	Nash, Sr.	
D497,778 S *	11/2004	Rich .....	D7/608
D526,855 S	8/2006	Wolff	
D534,807 S *	1/2007	Smay .....	D9/503
H2217 H	6/2008	Smay	
D599,609 S	9/2009	Ruffoni	
D613,020 S	3/2010	Yang	
D618,491 S	6/2010	Welk	
D629,691 S *	12/2010	Cresswell .....	D9/500
D654,762 S	2/2012	Gilbert	
D666,061 S *	8/2012	Ying .....	D7/629
D675,066 S *	1/2013	Conlin .....	D7/608
D677,124 S	3/2013	Montgomery	
D680,387 S *	4/2013	Hopkins .....	D7/629
D708,013 S	7/2014	Krenkler	
D728,314 S *	5/2015	Carstensen .....	D7/510
D753,445 S	4/2016	Khalifa	
D754,536 S *	4/2016	Arriaga .....	D9/436
D764,234 S *	8/2016	Lee .....	D7/531
D766,661 S *	9/2016	Bodum .....	D7/523
D784,137 S *	4/2017	Cates .....	D9/500
D787,893 S *	5/2017	Seiders .....	D7/608
D794,380 S	8/2017	Rodriguez	
D798,650 S	10/2017	Joseph	
D813,607 S *	3/2018	Nally .....	D7/536
D823,062 S *	7/2018	Goodwin .....	D7/511
D832,050 S *	10/2018	Diener .....	D7/510
D839,676 S *	2/2019	Seiders .....	D7/523
D839,677 S *	2/2019	Seiders .....	D7/523
D840,744 S	2/2019	Lights	
29,688,048	4/2019	Jewett	
D849,543 S *	5/2019	Augustyniak .....	D9/504
D849,559 S	5/2019	Swenson	
D850,206 S	6/2019	Lyons	
D853,789 S	7/2019	Adams, Jr.	
10,479,585 B2 *	11/2019	Seiders .....	B65D 25/2835
D871,159 S *	12/2019	Ellison .....	D7/587
D876,876 S	3/2020	Wang	
D876,905 S *	3/2020	Seiders .....	D7/608
D878,874 S *	3/2020	Seiders .....	D7/608
D879,564 S	3/2020	Adams, Jr.	
D882,343 S	4/2020	Rane	

(56) **References Cited**  
U.S. PATENT DOCUMENTS

1,810,543 A	6/1931	Trupiano	
D263,581 S *	3/1982	Kaye .....	D13/103
D273,167 S	3/1984	Carlson	
D286,604 S *	11/1986	Bierlein .....	D11/152
D299,102 S	12/1988	Maki	
D306,972 S	4/1990	Moloney	
D312,160 S	11/1990	Calvi	





D888,505	S	*	6/2020	Seiders	.....	D7/624.2
D889,900	S	*	7/2020	Cheng	.....	D7/354
D889,913	S	*	7/2020	Seiders	.....	D7/608
D893,948	S	*	8/2020	Ou	.....	D7/507
2004/0080930	A1	*	4/2004	Winters	.....	B65D 23/14 362/101
2008/0217335	A1		9/2008	Chen		
2015/0335132	A1	*	11/2015	Hall	.....	A45D 40/0075 222/146.5
2017/0188742	A1		7/2017	Olsson		
2018/0296041	A1	*	10/2018	Oh	.....	A47J 45/071
2018/0312322	A1	*	11/2018	Canales Kell	.....	B65D 23/001

FOREIGN PATENT DOCUMENTS

JP 2014205050 10/2014

OTHER PUBLICATIONS

Best Whiskey Sour, announced Jun. 7, 2020 [online], retrieved Oct. 2, 2020, retrieved from internet, <https://www.acouplecooks.com/naturally-sweetened-whiskey-sour/>.\*

23 of the Best Bourbon Cocktails, announced Jul. 23, 2020 [online], retrieved Oct. 2, 2020, retrieved from internet, <https://www.townandcountrymag.com/leisure/drinks/g23119252/bourbon-cocktails/>.\*

Pozzetti Carapina Round Container, announced © 2020 [online], retrieved Oct. 2, 2020, retrieved from internet, <https://www.gelatosupply.com/products/pozzetti-carapina-round-container-large>.\*

OXO 3-Piece POP Round Canister Set, announced © 2019 [online], retrieved Oct. 2, 2020, retrieved from internet, <https://www.oxo.com/3-piece-pop-round-canister-set-white.html>.\*

Office Action, U.S. Appl. No. 29/688,048, dated Jun. 24, 2020.

The Original Baking Can—Cylindrical Vertical Baking Can, announced Oct. 16, 2019 [online], retrieved Jun. 18, 2020, retrieved from Internet <URL: [https://www.amazon.com/Original-Baking-Can-Cylindrical-Vertical/dp/B07RV94FSZ/ref=cm\\_cr\\_arp\\_d\\_product\\_top?ie=UTF8](https://www.amazon.com/Original-Baking-Can-Cylindrical-Vertical/dp/B07RV94FSZ/ref=cm_cr_arp_d_product_top?ie=UTF8)>.

The Original Baking Can—Cylindrical Vertical Baking Can, announced Aug. 12, 2019 [online], retrieved Jun. 18, 2020, retrieved from Internet, <URL: [https://www.tergolw.com/index.php?main\\_page=product\\_info&products\\_id=409265](https://www.tergolw.com/index.php?main_page=product_info&products_id=409265)>.

Tablecraft Products Hu2 Utensil Holder, announced Oct. 15, 2016 [online], retrieved Jun. 18, 2020, retrieved from Internet <URL: <https://www.amazon.com/TableCraft-Products-HU2-Utensil-Stainless/dp/B00FNVR6SK>>.

Stainless Steel Utensil Holder, announced Apr. 7, 2018 [online], retrieved Jun. 18, 2020, retrieved from Internet <URL: <https://www.koleimports.com/stainless-steel-utensil-holder>>.

Stainless Whiskey Old Fashioned Glass, announced Jun. 18, 2016 [online], retrieved Jun. 19, 2020, retrieved from Internet, <URL: <https://www.amazon.com/Stainless-Whiskey-Old-Fashioned-Glass/dp/B01JQDVFMI>>.

Office Action Response, U.S. Appl. No. 29/688,048, filed Aug. 13, 2020.

Kaiser, Kaiser 621258 Half Round Loaf Pan “Classic” 11.81In, Black, web page [online] [[retrieved on Apr. 18, 2019], published at least by Mar. 15, 2019, retrieved from the internet: <[https://www.amazon.com/Kaiser-621258-Round-Classic-11-81In/dp/B00008WX80/ref=sr\\_1\\_36?keywords=bread+baking+pans+circular&qid=1552694428&s=gateway&sr=8-36](https://www.amazon.com/Kaiser-621258-Round-Classic-11-81In/dp/B00008WX80/ref=sr_1_36?keywords=bread+baking+pans+circular&qid=1552694428&s=gateway&sr=8-36)>.

Preliminary Amendment, U.S. Appl. No. 29/688,048, dated Jun. 4, 2019.

Notice of Allowance and Fee(s) Due (including a Notice of Allowability for a Design Application section, an Examiner’s Comment and Amendment section, a Examiner’s Comment section, a Drawings section, an Examiner’s Amendment section, and a Specification section), pp. 1-10, U.S. Appl. No. 29/688,048, dated Nov. 27, 2020.

Amendment After Allowance, U.S. Appl. No. 29/688,048, filed Dec. 15, 2020, pp. 1-11.

\* cited by examiner

*Primary Examiner* — Dana K Weiland  
*Assistant Examiner* — Messina L Smith  
 (74) *Attorney, Agent, or Firm* — Austin Rapp

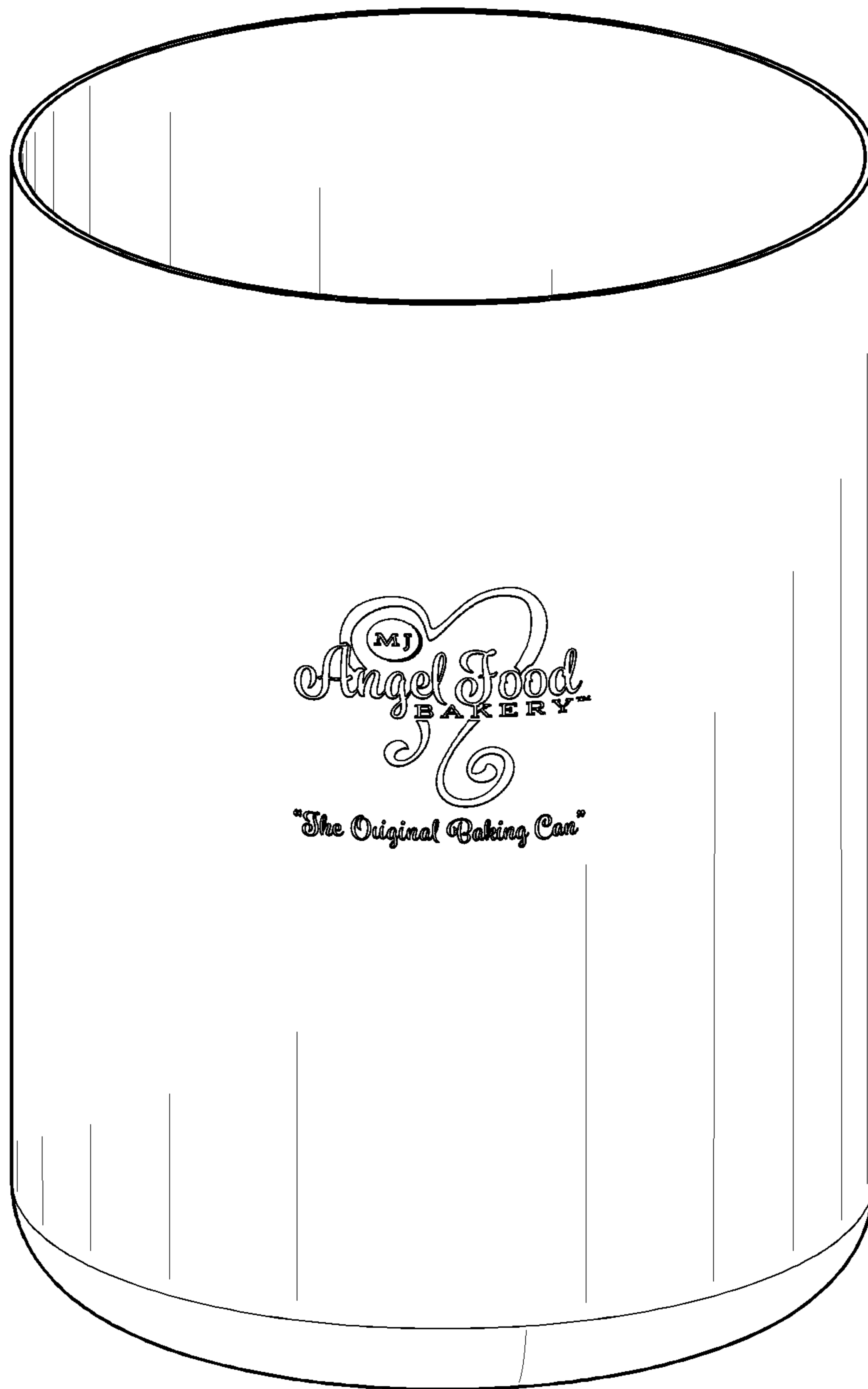
(57) **CLAIM**

The ornamental design for a baking pan, as shown and described.

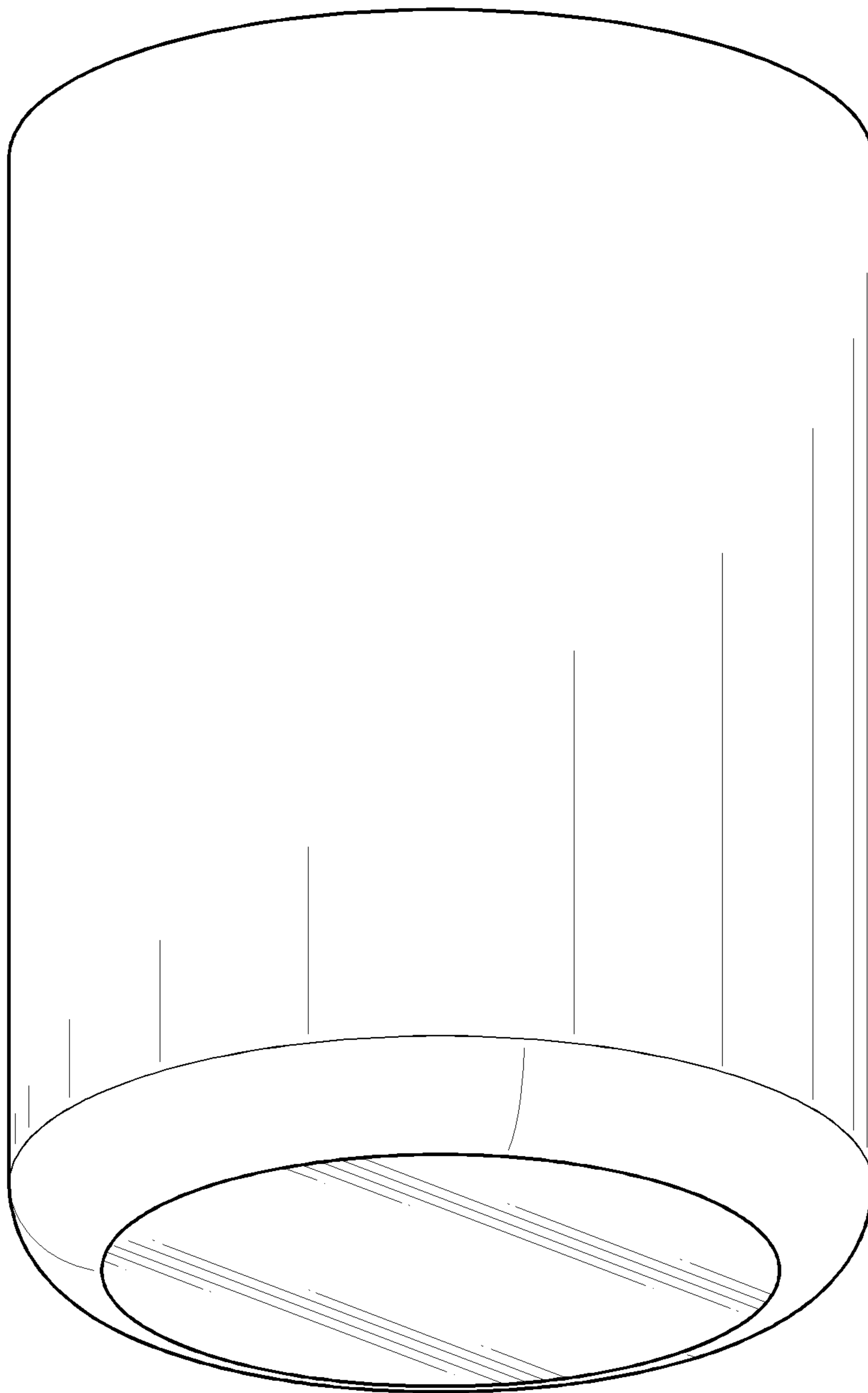
**DESCRIPTION**

FIG. 1 is a top perspective view of a first embodiment of a baking pan, according to my new design;  
 FIG. 2 is a bottom perspective view of the first embodiment of the baking pan of FIG. 1;  
 FIG. 3 is a front elevational view of the first embodiment of the baking pan of FIG. 1;  
 FIG. 4 is a rear elevational view of the first embodiment of the baking pan of FIG. 1;  
 FIG. 5 is a top view of the first embodiment of the baking pan of FIG. 1;  
 FIG. 6 is a bottom view of the first embodiment of the baking pan of FIG. 1;  
 FIG. 7 is a right side elevational view of the first embodiment of the baking pan of FIG. 1;  
 FIG. 8 is a left side elevational view of the first embodiment of the baking pan of FIG. 1;  
 FIG. 9 is a front cross-sectional view of the first embodiment of the baking pan of FIG. 1 taken in the direction of line 9-9 in FIG. 8;  
 FIG. 10 is a top perspective view of a second embodiment of the baking pan;  
 FIG. 11 is a bottom perspective view of the second embodiment of the baking pan of FIG. 10;  
 FIG. 12 is a front elevational view of the second embodiment of the baking pan of FIG. 10;  
 FIG. 13 is a rear elevational view of the second embodiment of the baking pan of FIG. 10;  
 FIG. 14 is a top view of the second embodiment of the baking pan of FIG. 10;  
 FIG. 15 is a bottom view of the second embodiment of the baking pan of FIG. 10;  
 FIG. 16 is a right side elevational view of the second embodiment of the baking pan of FIG. 10;  
 FIG. 17 is a left side elevational view of the second embodiment of the baking pan of FIG. 10; and,  
 FIG. 18 is a front cross-sectional view of the second embodiment of the baking pan of FIG. 10 taken in the direction of line 18-18 in FIG. 17.  
 The broken lines in the figures depict portions of the baking pan that form no part of the claimed design.  
 The MJ ANGEL FOOD BAKERY THE ORIGINAL BAKING CAN shown in the first embodiment of the claimed design is a registered trademark of MJ Angel Food Bakery L.L.C. and forms part of the claimed design.

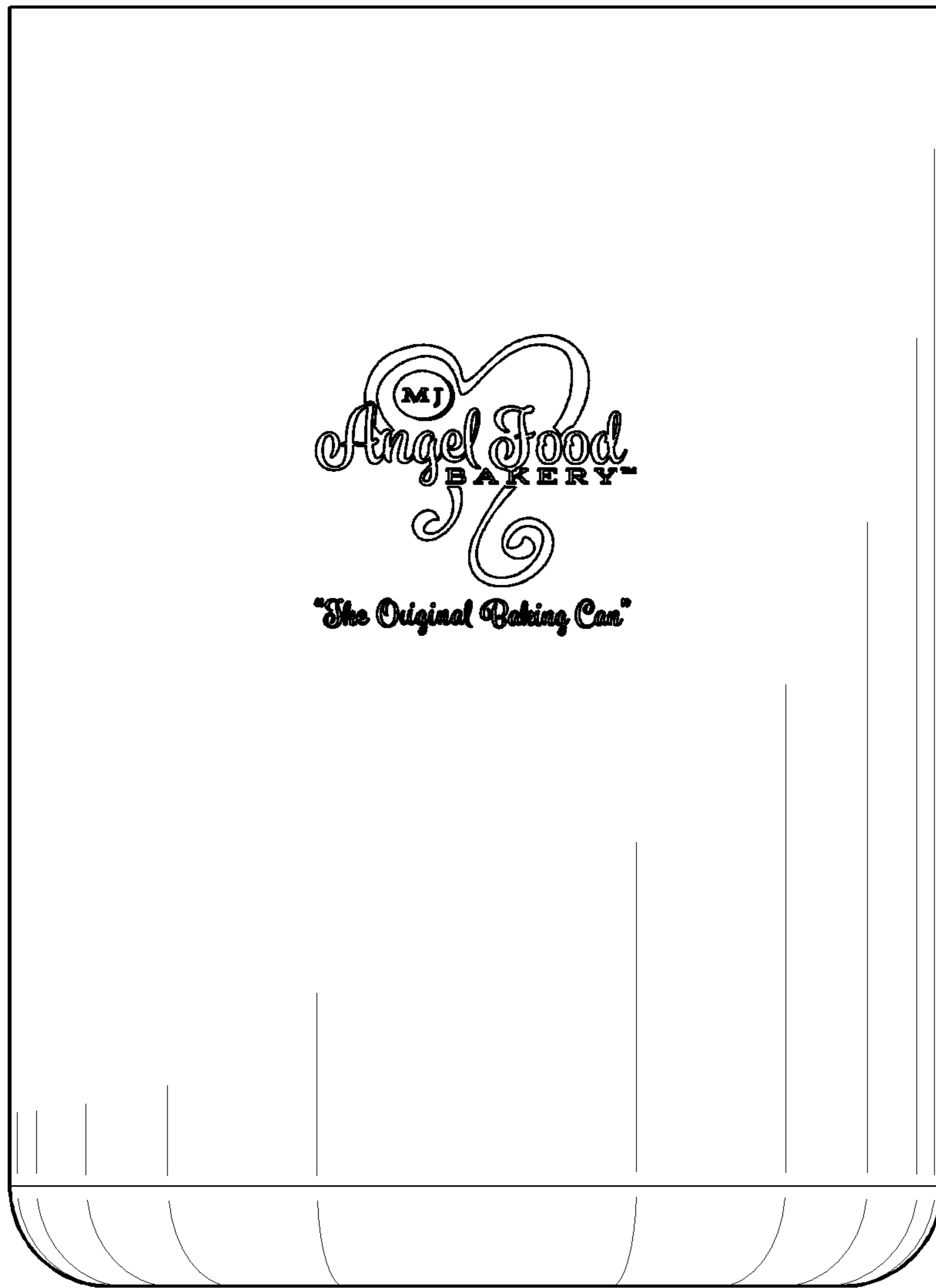
**1 Claim, 18 Drawing Sheets**



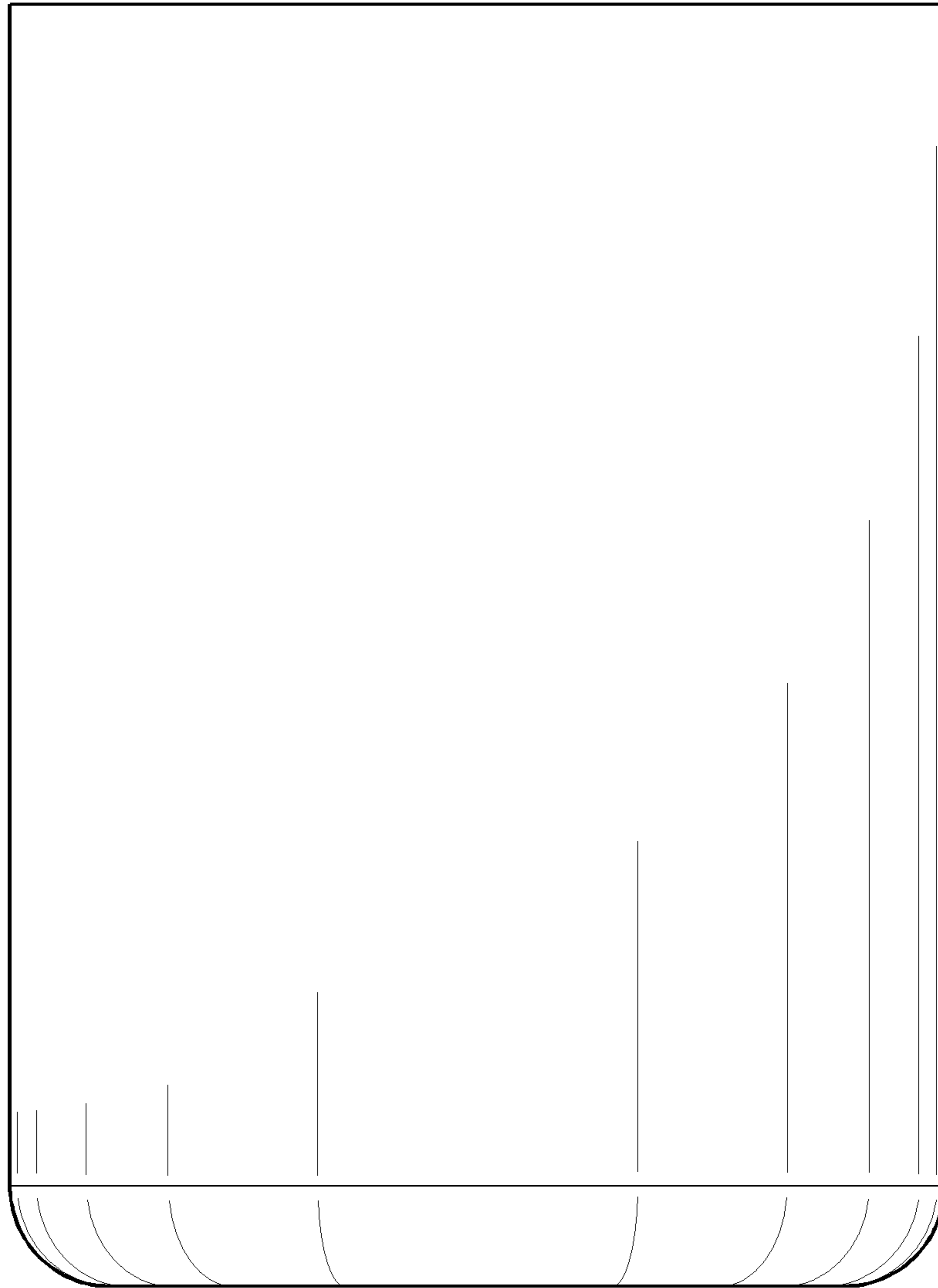
**FIG. 1**



**FIG. 2**

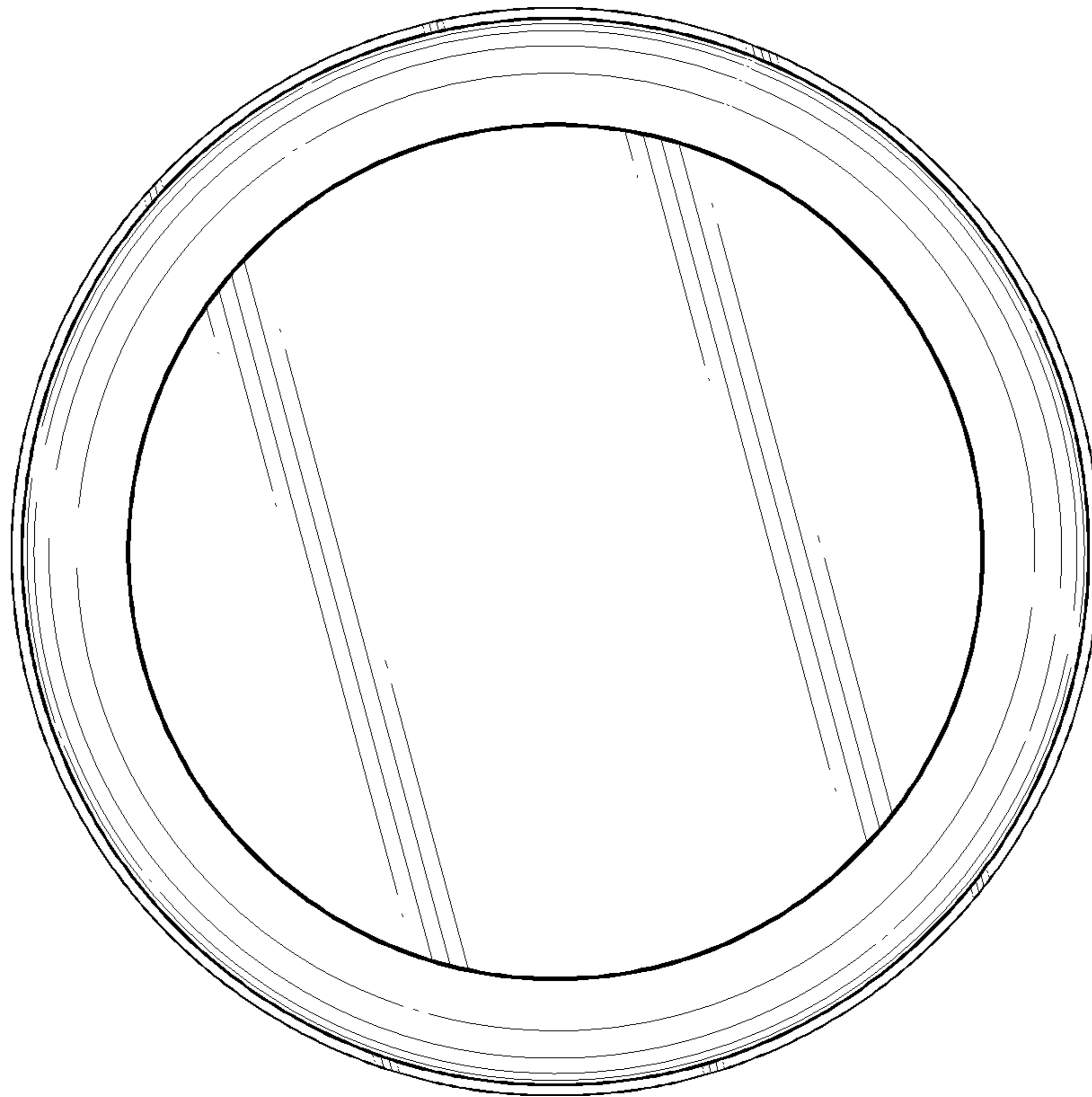


**FIG. 3**

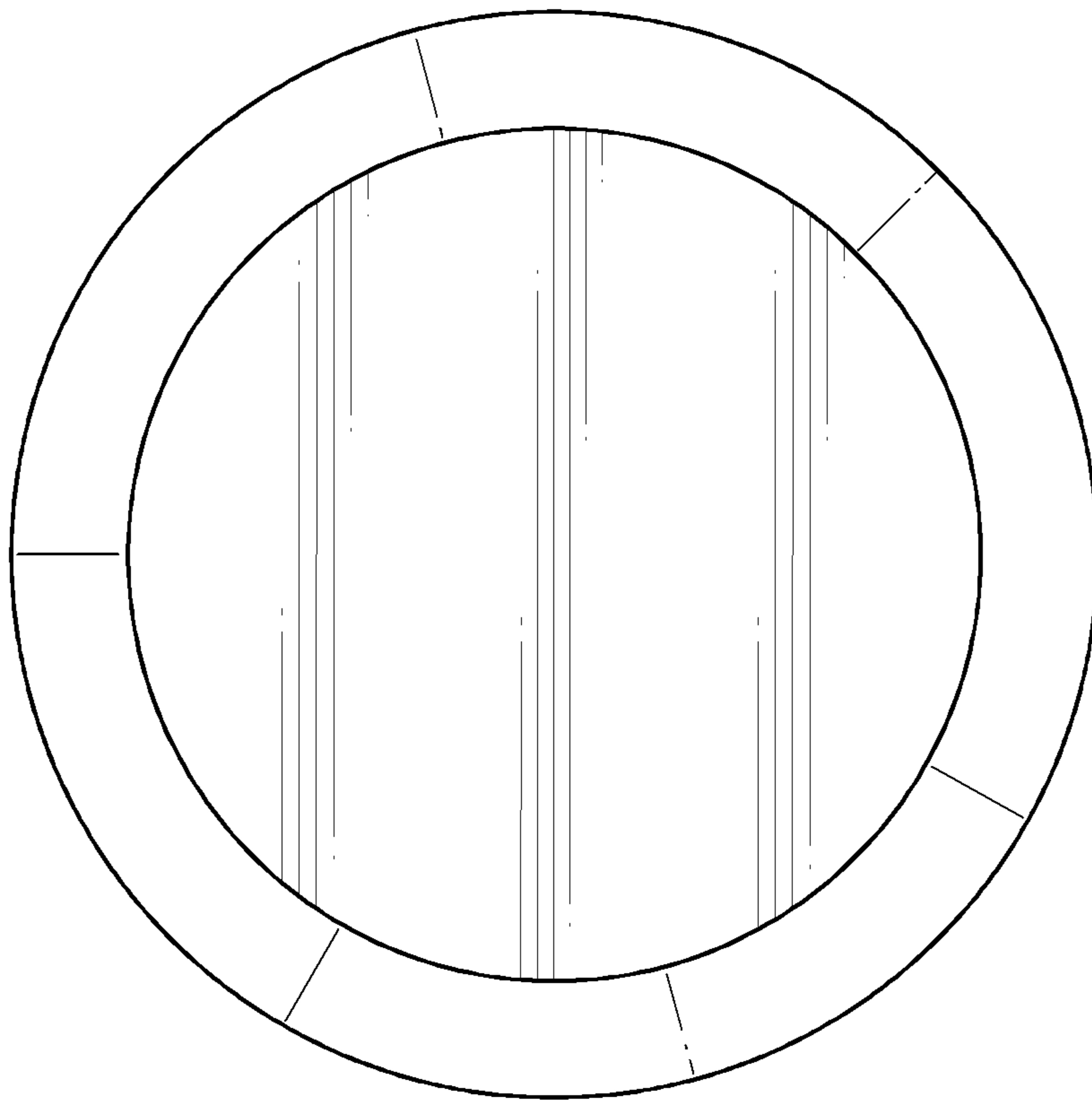


**FIG. 4**



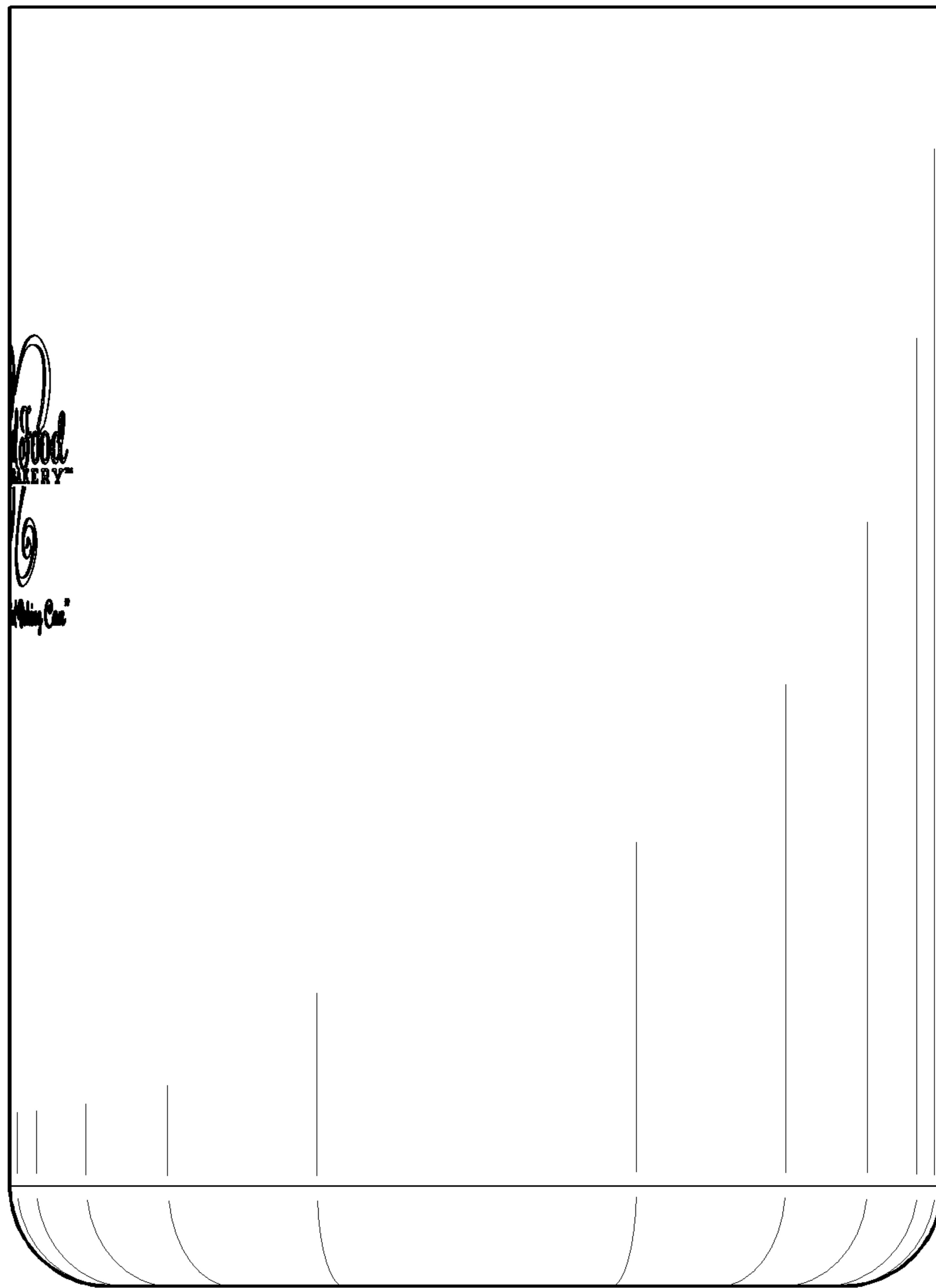


**FIG. 5**

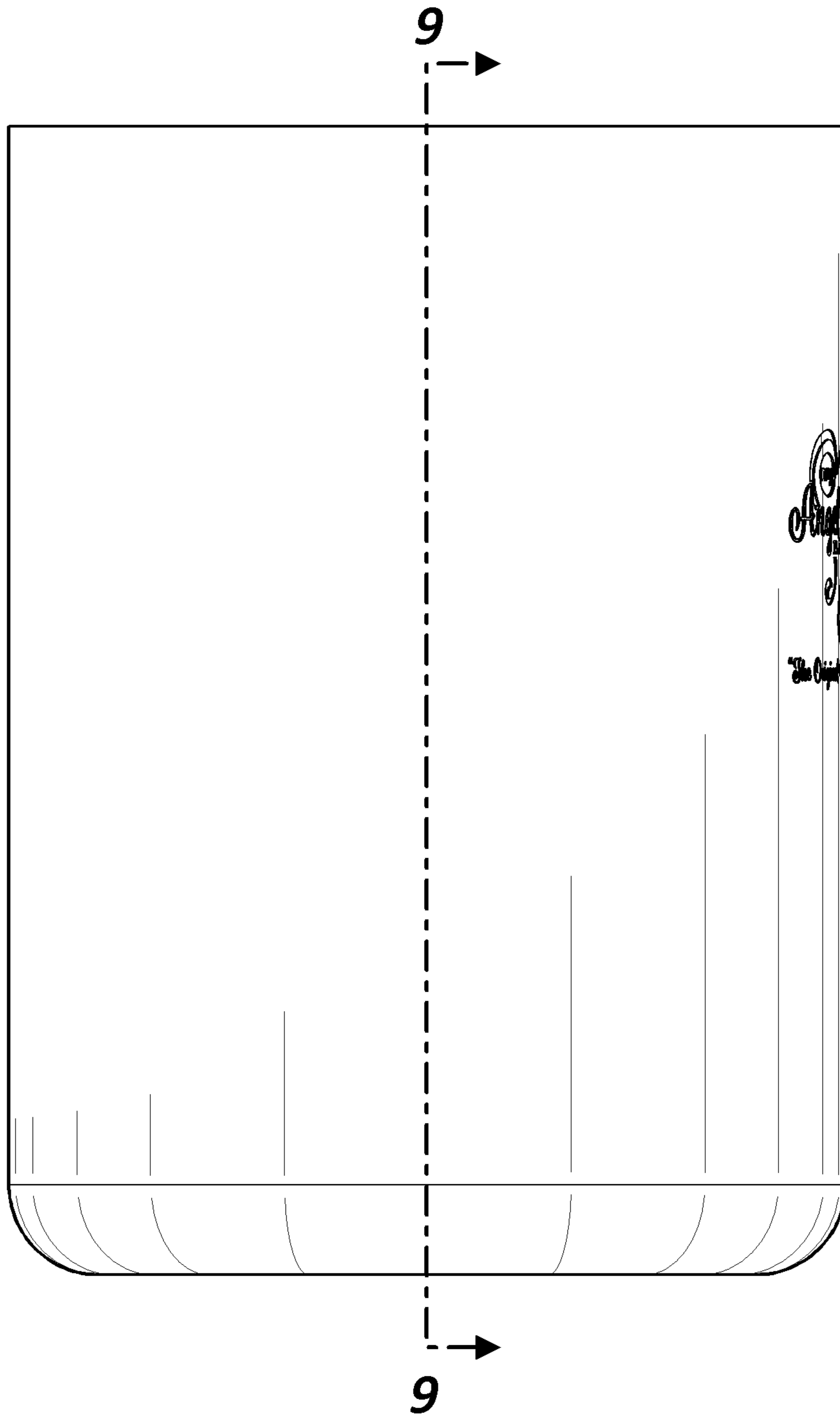


**FIG. 6**

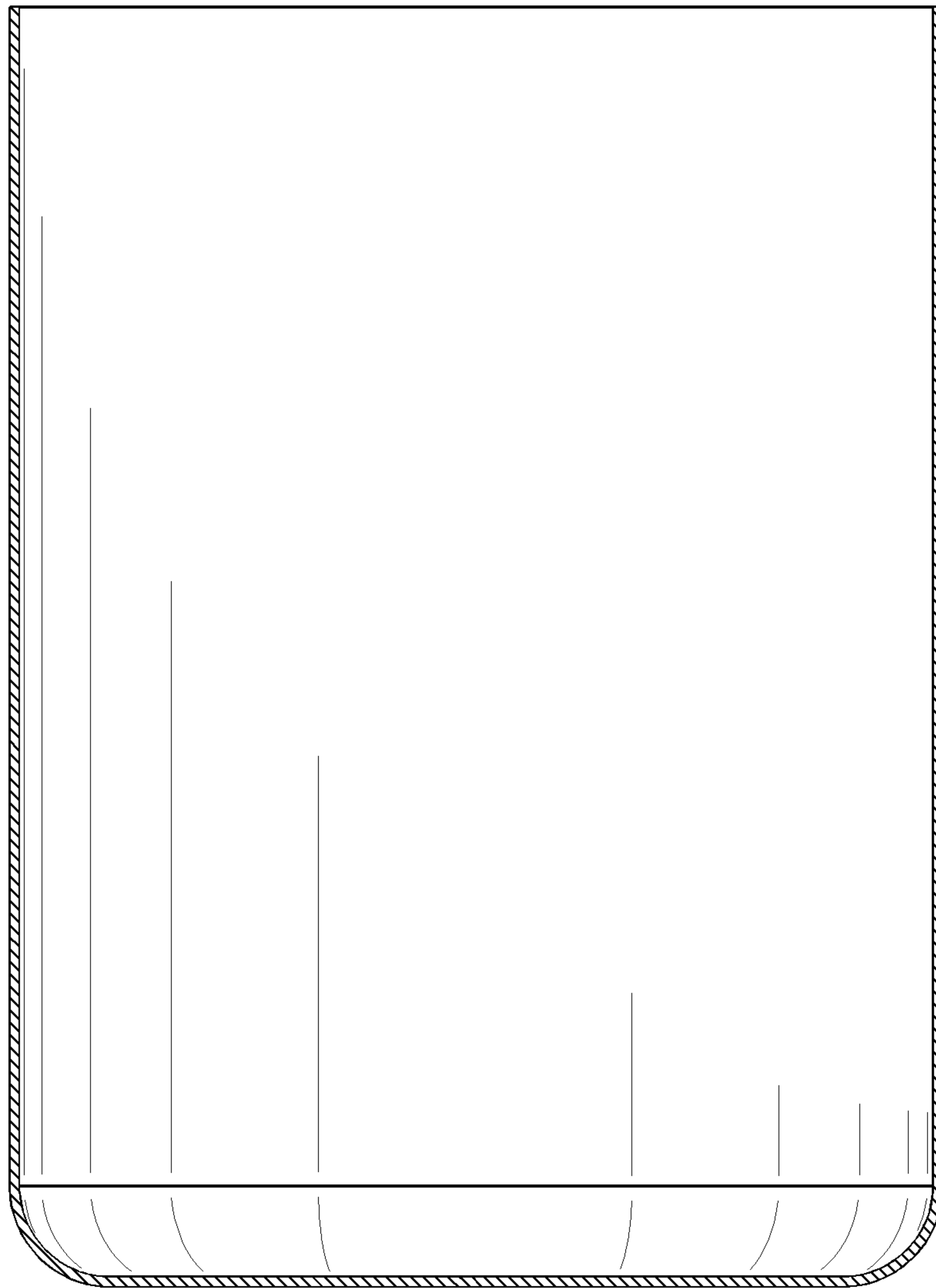




**FIG. 7**



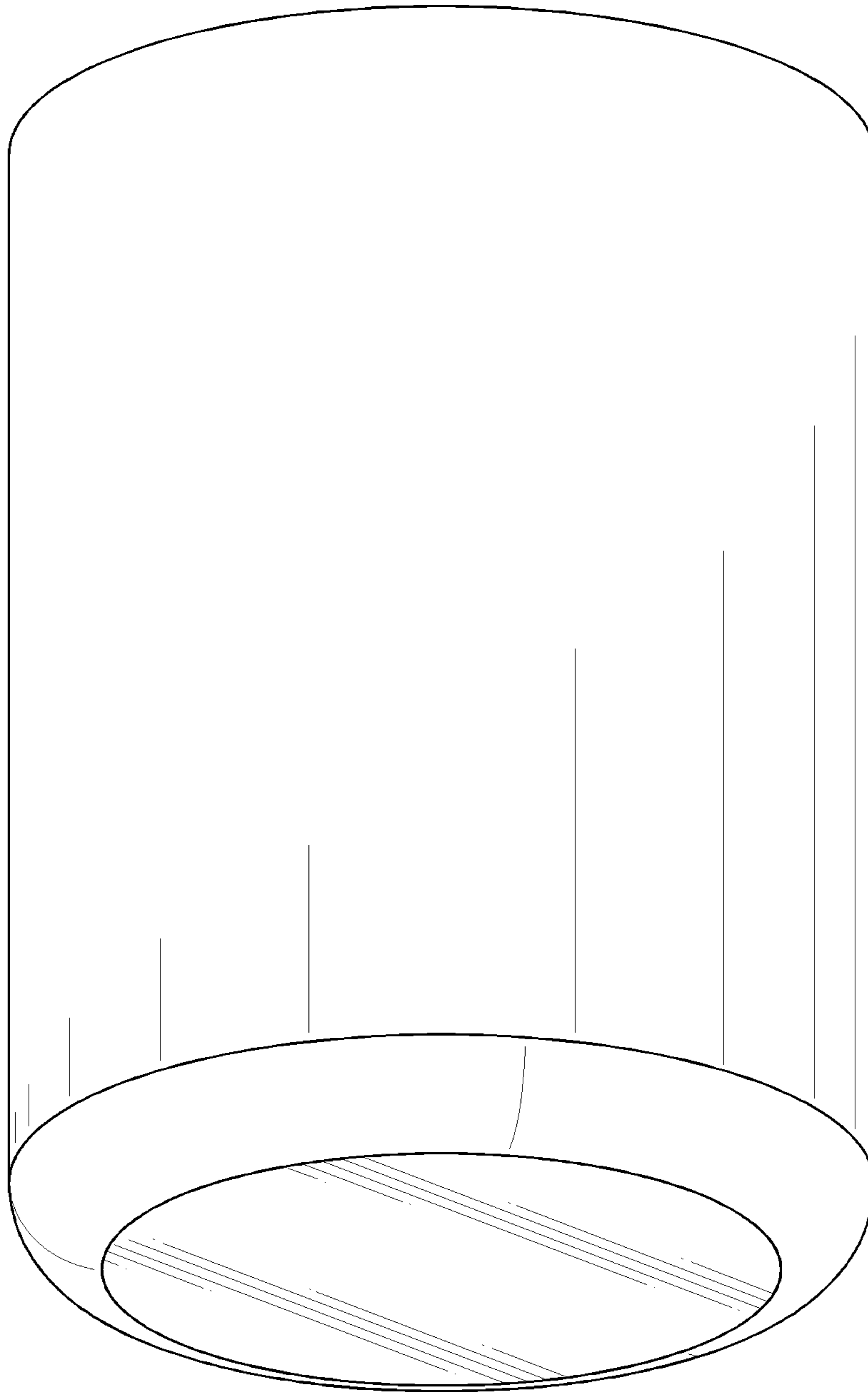
**FIG. 8**



**FIG. 9**

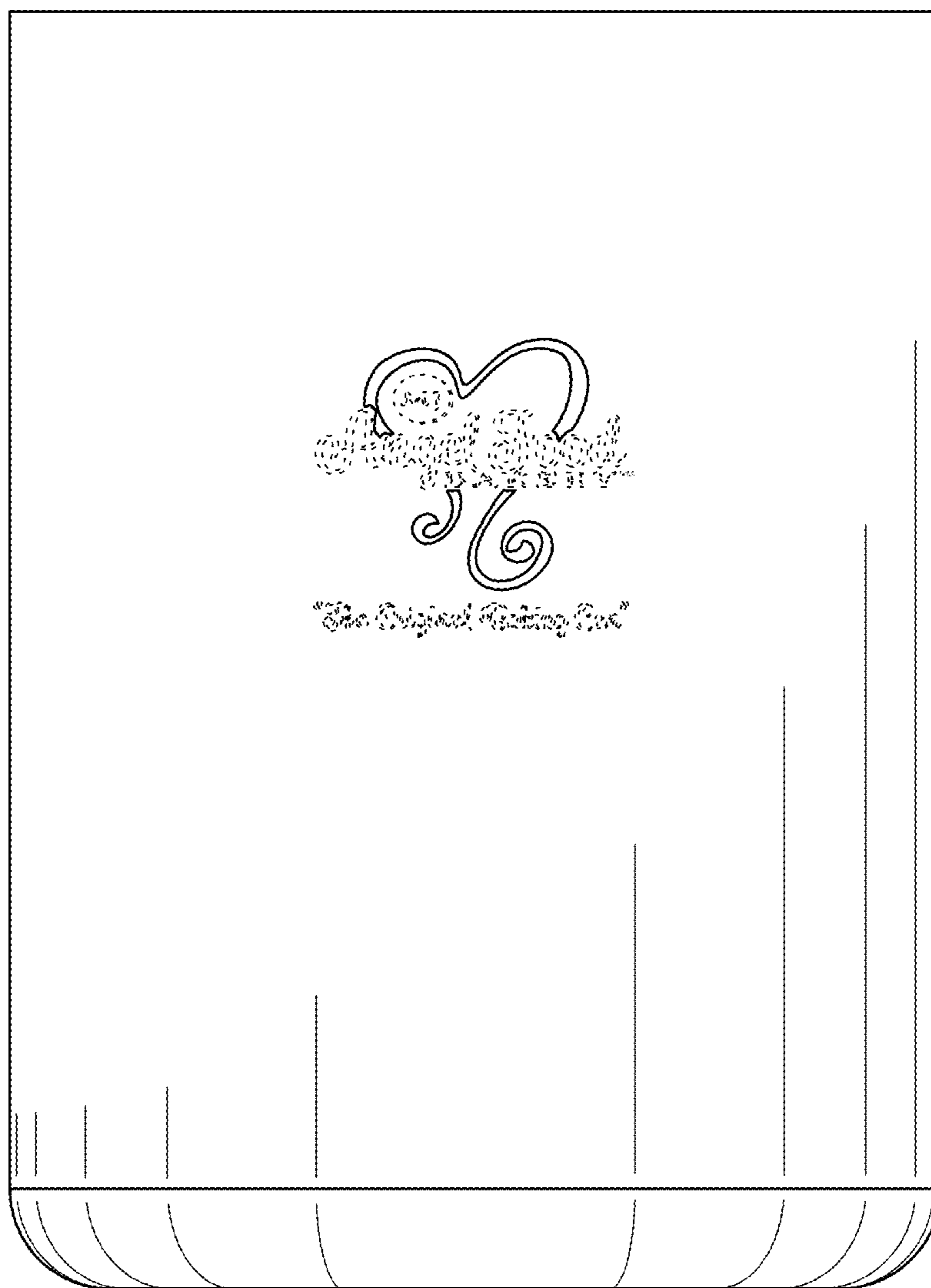


**FIG. 10**

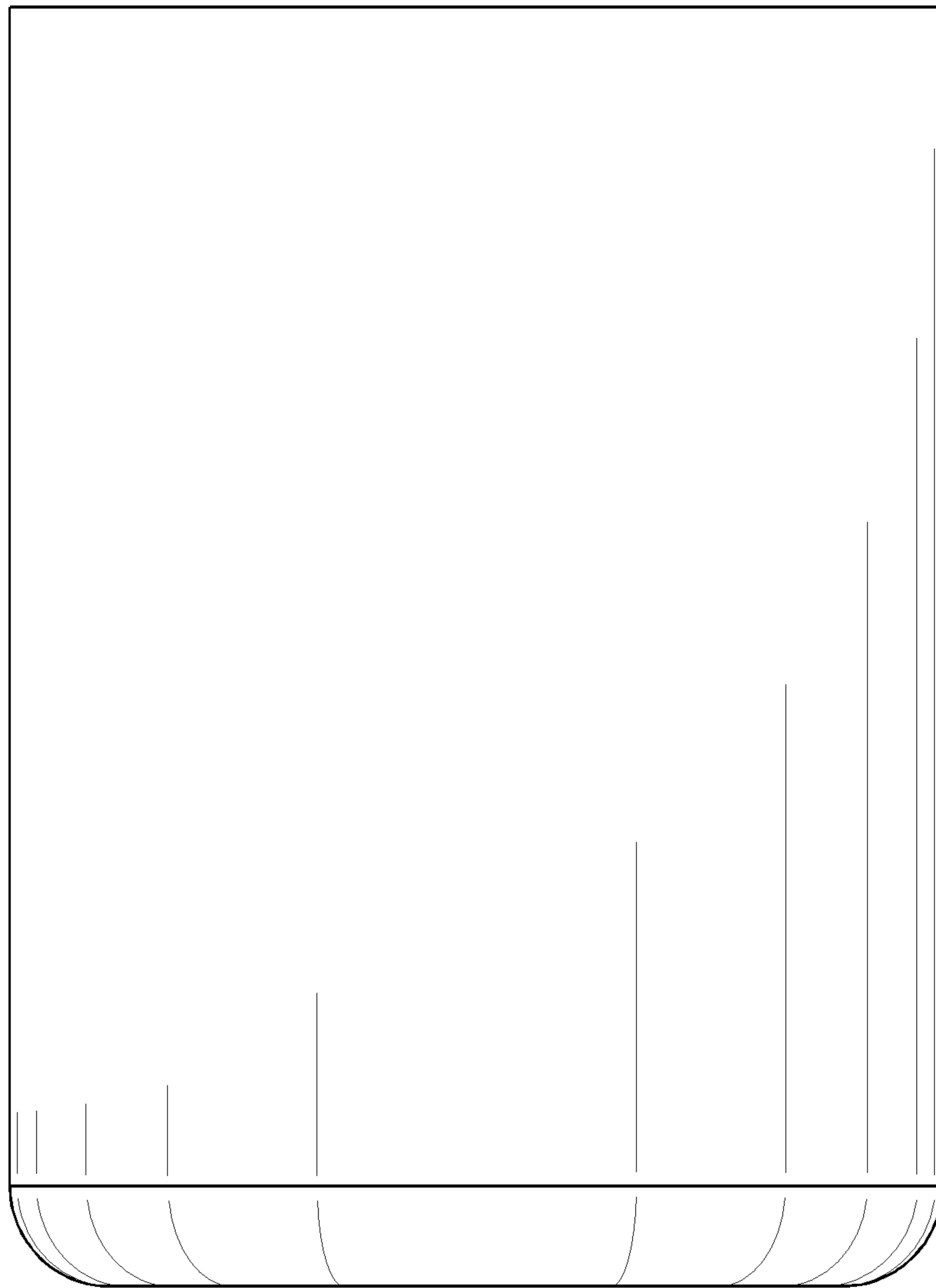


**FIG. 11**

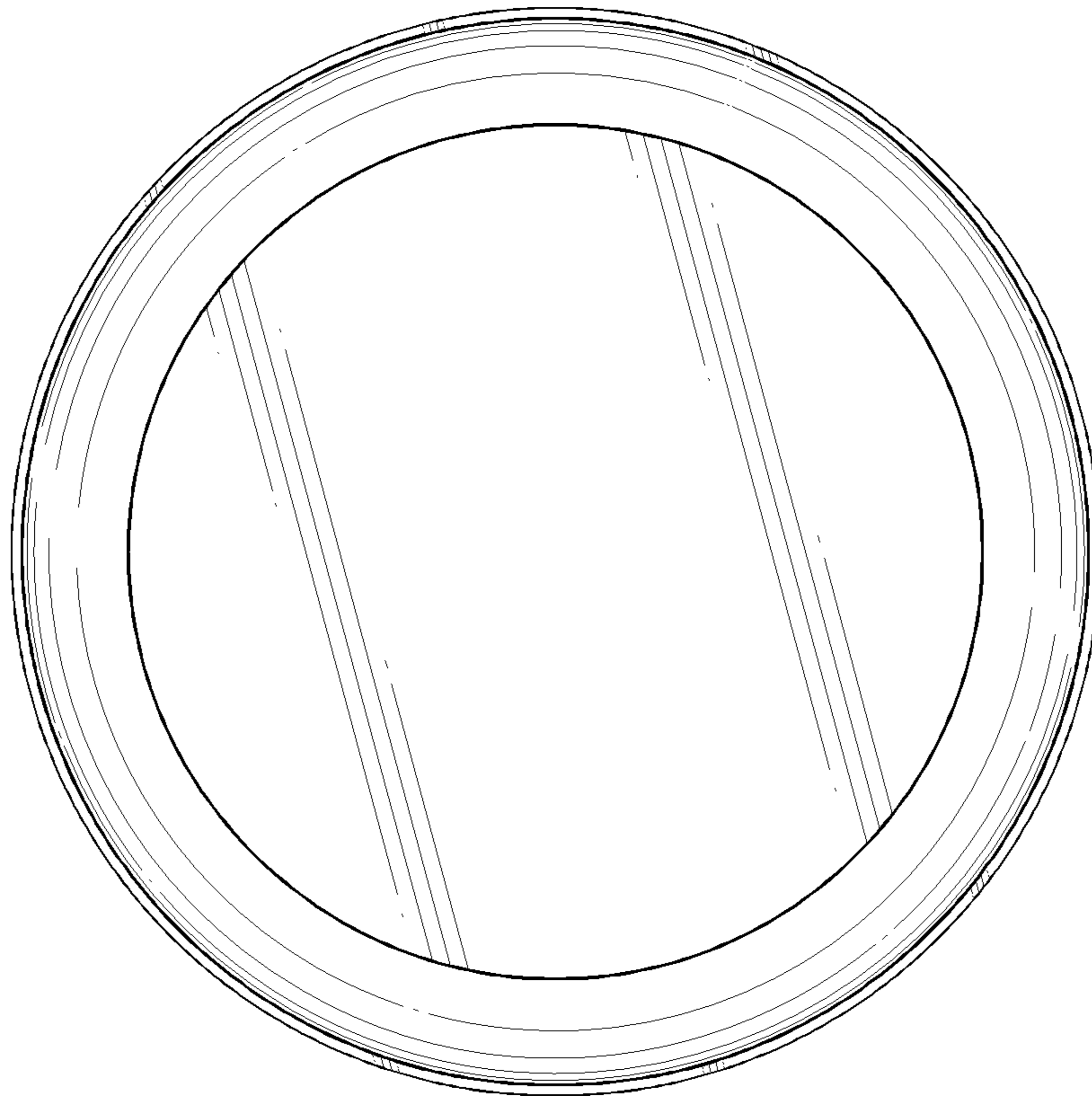




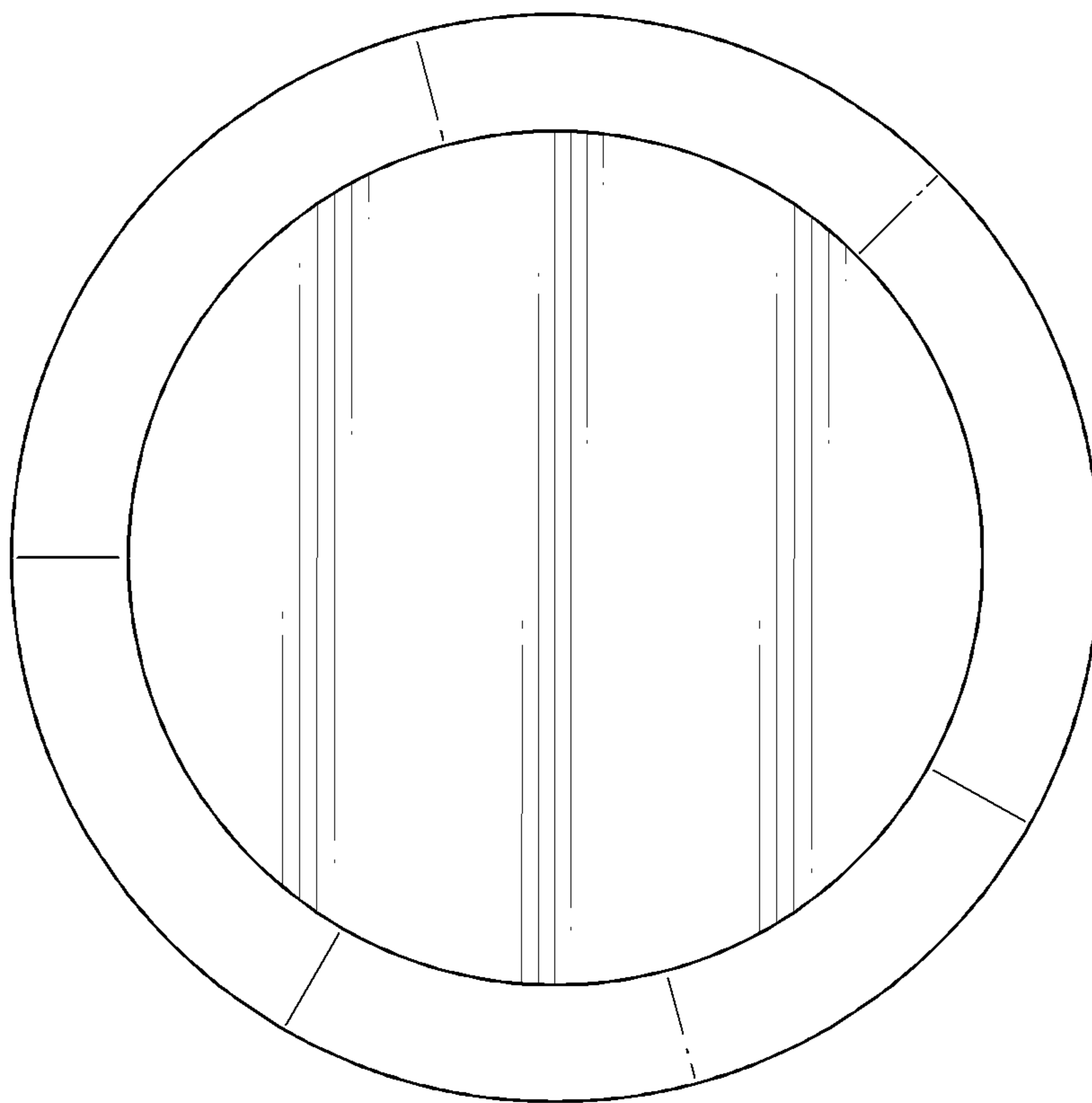
**FIG. 12**



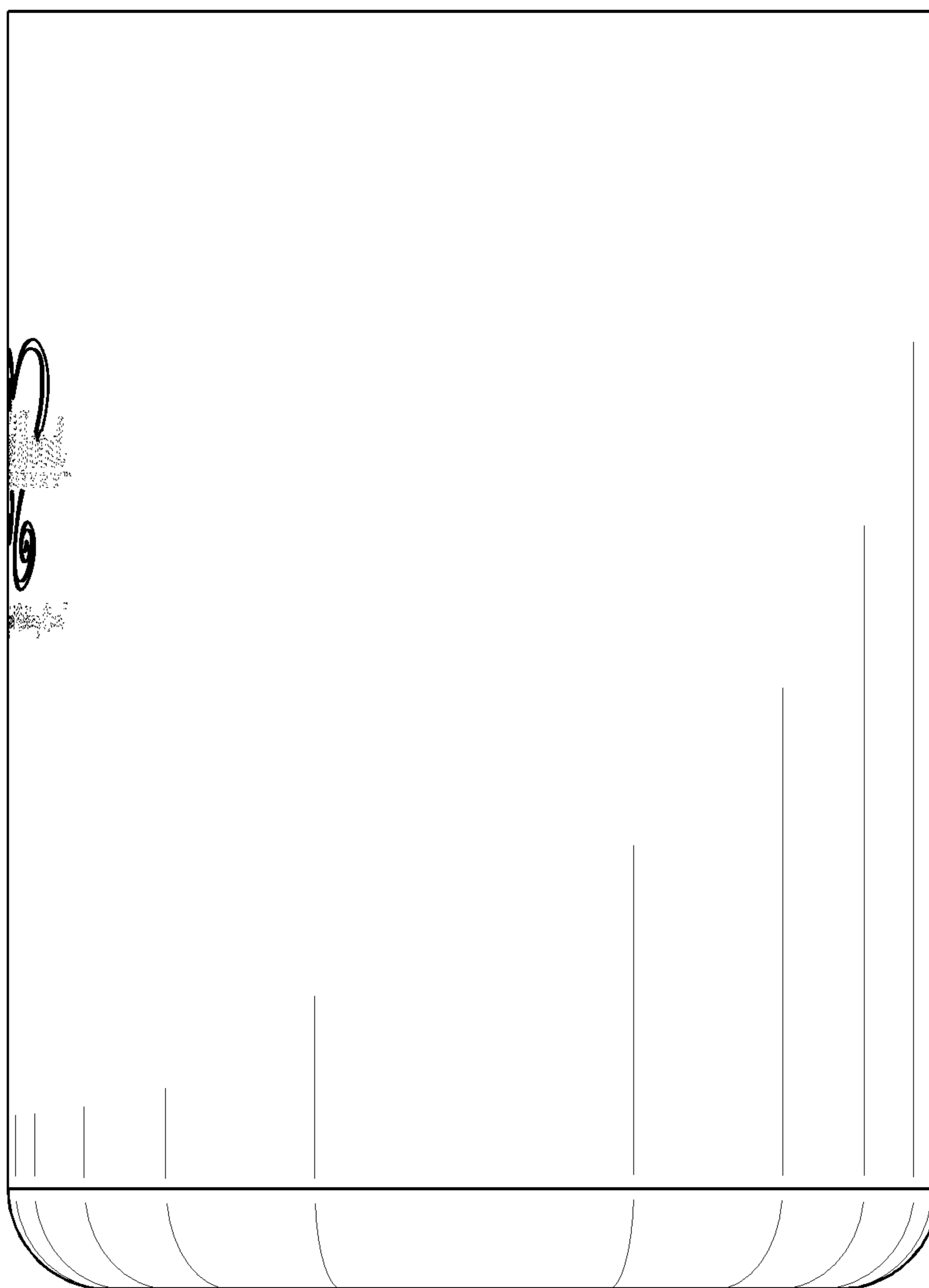
**FIG. 13**



**FIG. 14**

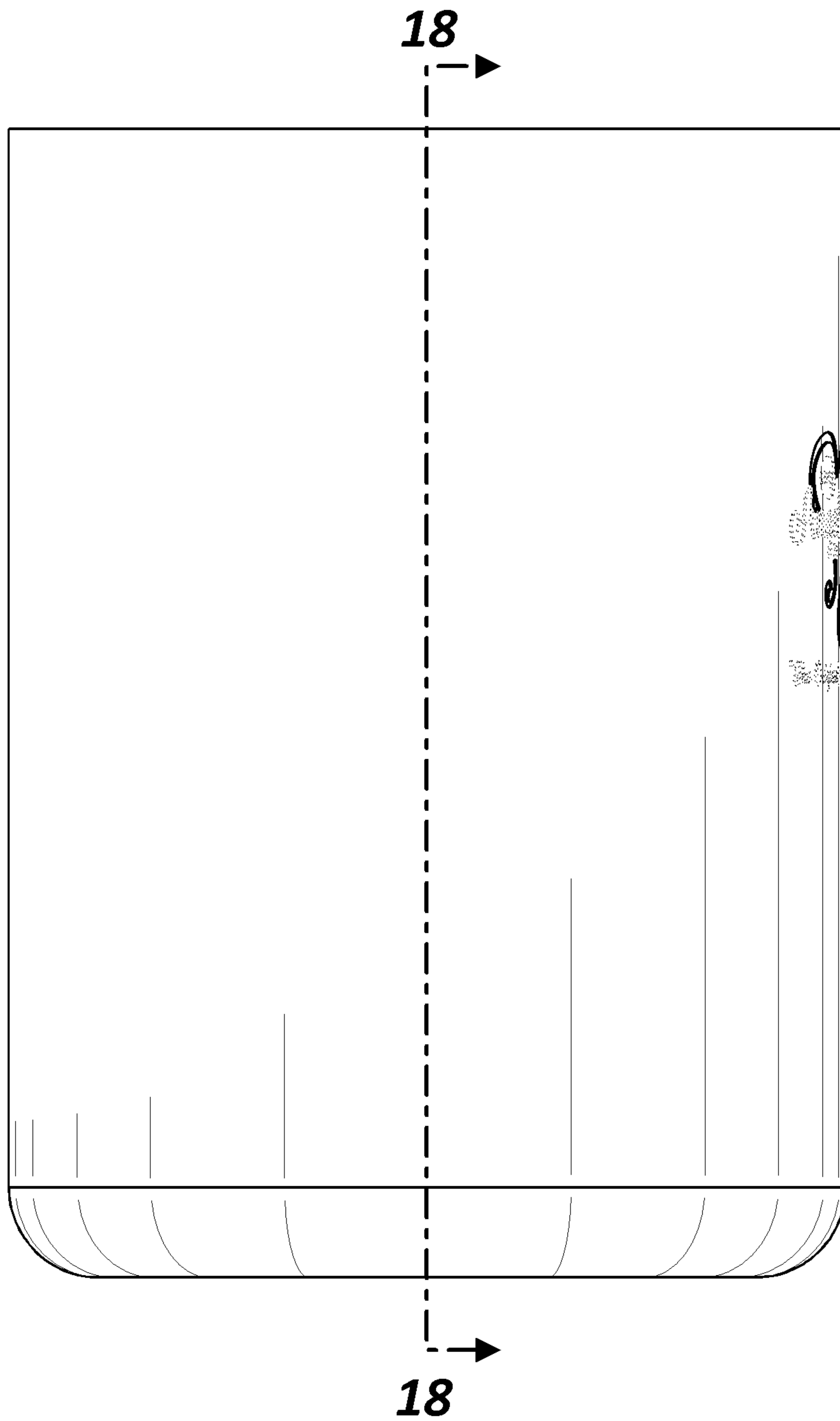


**FIG. 15**

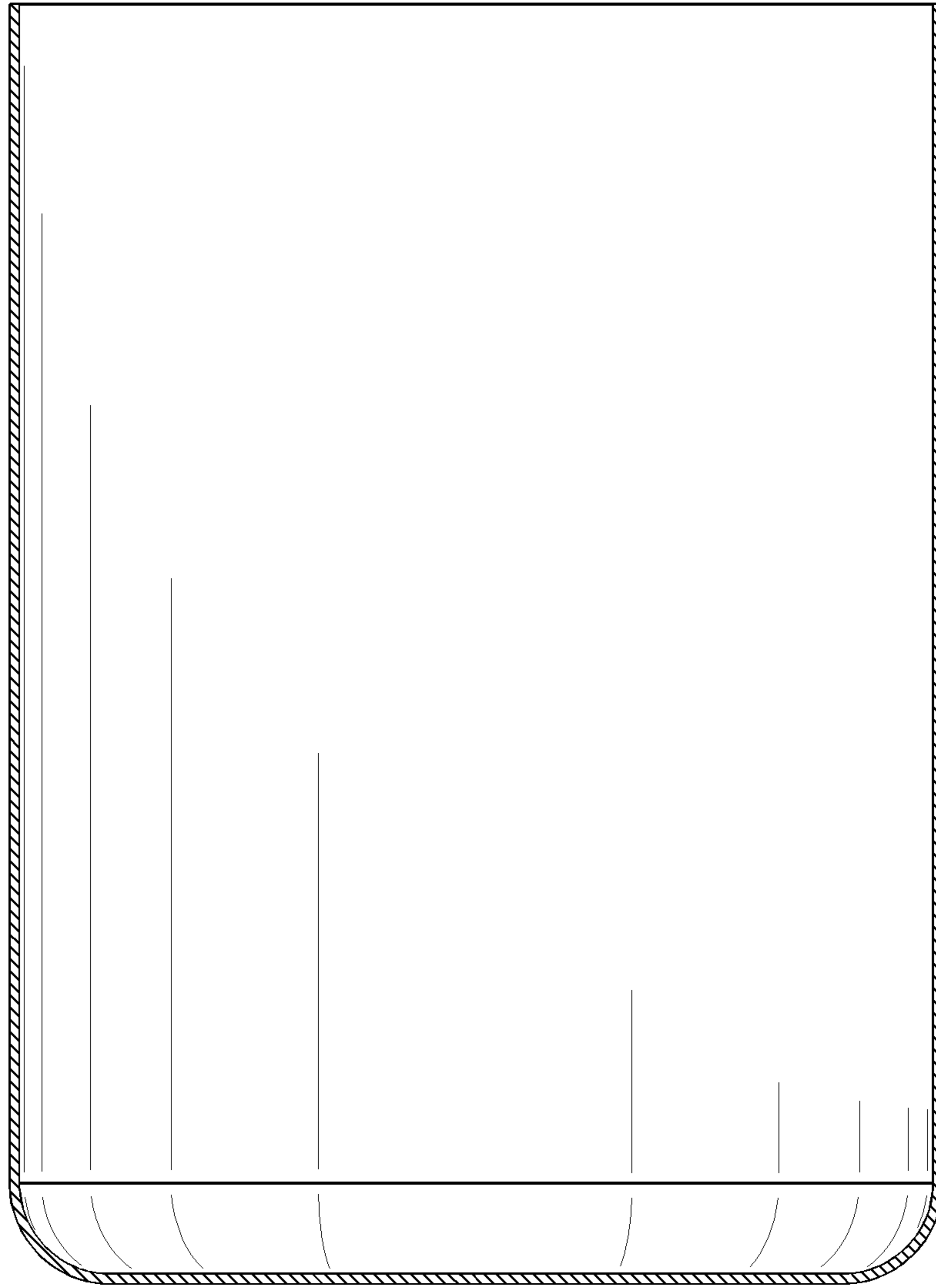


**FIG. 16**





**FIG. 17**



**FIG. 18**