



US00D935690S

(12) **United States Design Patent** (10) **Patent No.:** **US D935,690 S**  
**Huang** (45) **Date of Patent:** **\*\* Nov. 9, 2021**

(54) **LICE COMB**  
(71) Applicant: **Shenzhen Zhongyiliang Technology Co., Ltd.**, Shenzhen (CN)  
(72) Inventor: **Zuzhang Huang**, Shenzhen (CN)  
(\*\*) Term: **15 Years**  
(21) Appl. No.: **29/772,596**  
(22) Filed: **Mar. 3, 2021**  
(51) **LOC (13) Cl.** ..... **28-03**  
(52) **U.S. Cl.**  
USPC ..... **D28/24**  
(58) **Field of Classification Search**  
USPC ..... D28/7, 20-34, 39, 43; D30/158, 159  
CPC ..... A45D 24/00; A45D 24/005; A45D 24/02;  
A45D 24/04; A45D 24/06; A45D 24/14;  
A45D 24/22  
See application file for complete search history.

(56) **References Cited**  
U.S. PATENT DOCUMENTS  
D429,378 S \* 8/2000 Wu ..... D28/24  
D440,010 S \* 4/2001 Moura ..... D28/24  
D461,281 S \* 8/2002 Lee ..... D28/24

D472,346 S \* 3/2003 Lee ..... D28/24  
D495,447 S \* 8/2004 Wan ..... D28/24  
D699,890 S 2/2014 Leman  
D762,005 S 7/2016 Knutson  
D771,310 S \* 11/2016 He ..... D28/35  
D794,249 S \* 8/2017 Hou ..... D28/24  
D858,877 S 9/2019 Maor et al.

\* cited by examiner

Primary Examiner — Zenia I Bennett

(57) **CLAIM**

The ornamental design for a lice comb, as shown and described.

**DESCRIPTION**

FIG. 1 is a first perspective view of a lice comb showing my new design;  
FIG. 2 is a second perspective view thereof;  
FIG. 3 is a front view thereof;  
FIG. 4 is a back view thereof;  
FIG. 5 is a left side view thereof;  
FIG. 6 is a right side view thereof;  
FIG. 7 is a top view thereof; and,  
FIG. 8 is a bottom view thereof.  
The broken lines shown in, the drawings depict portions of the lice comb in which the design is embodied that form no part of the claimed design.

**1 Claim, 8 Drawing Sheets**

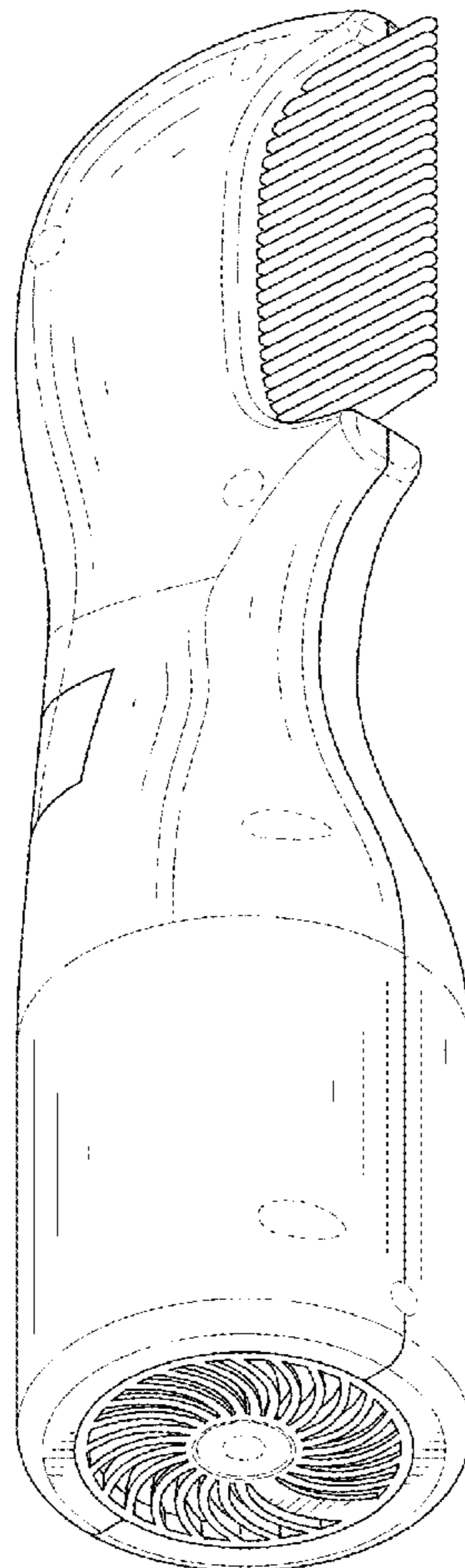

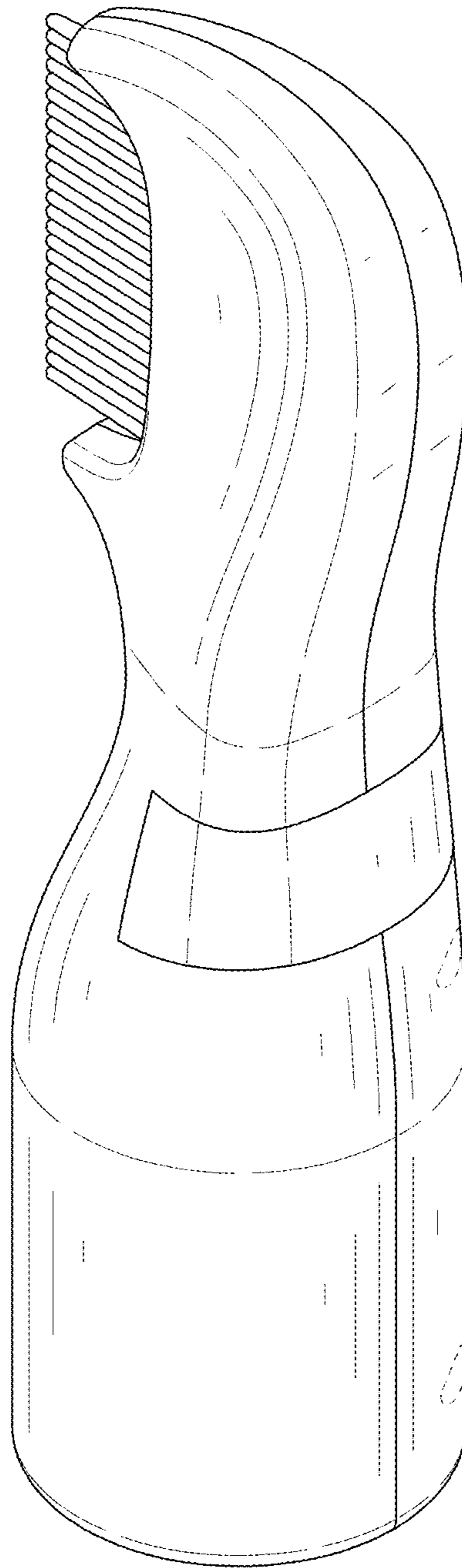

FIG. 1

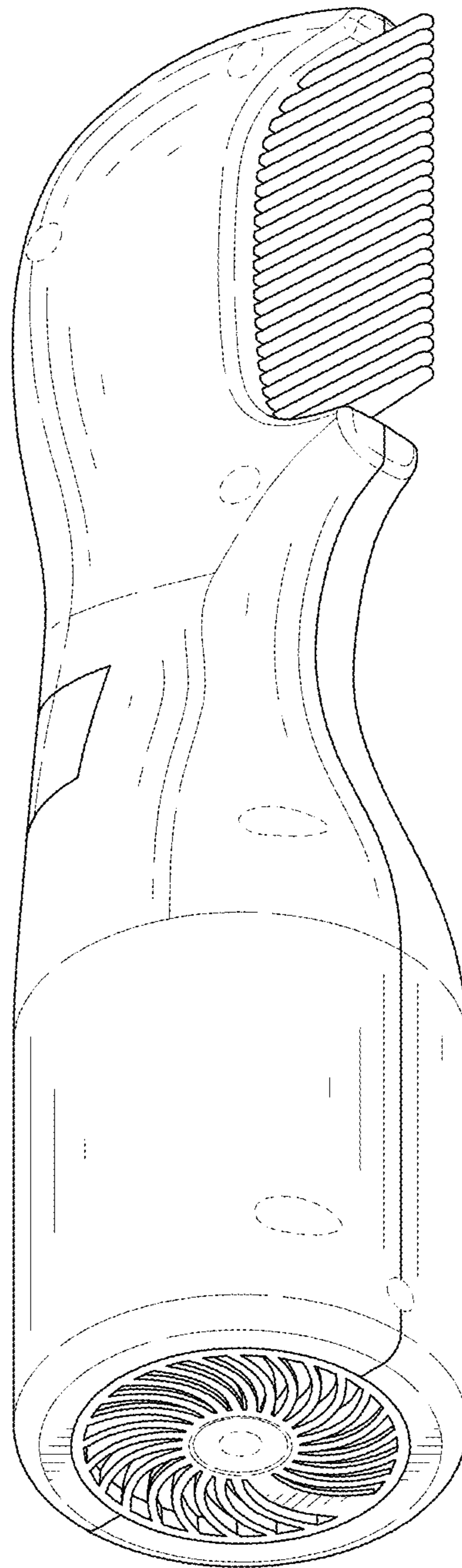

FIG. 2

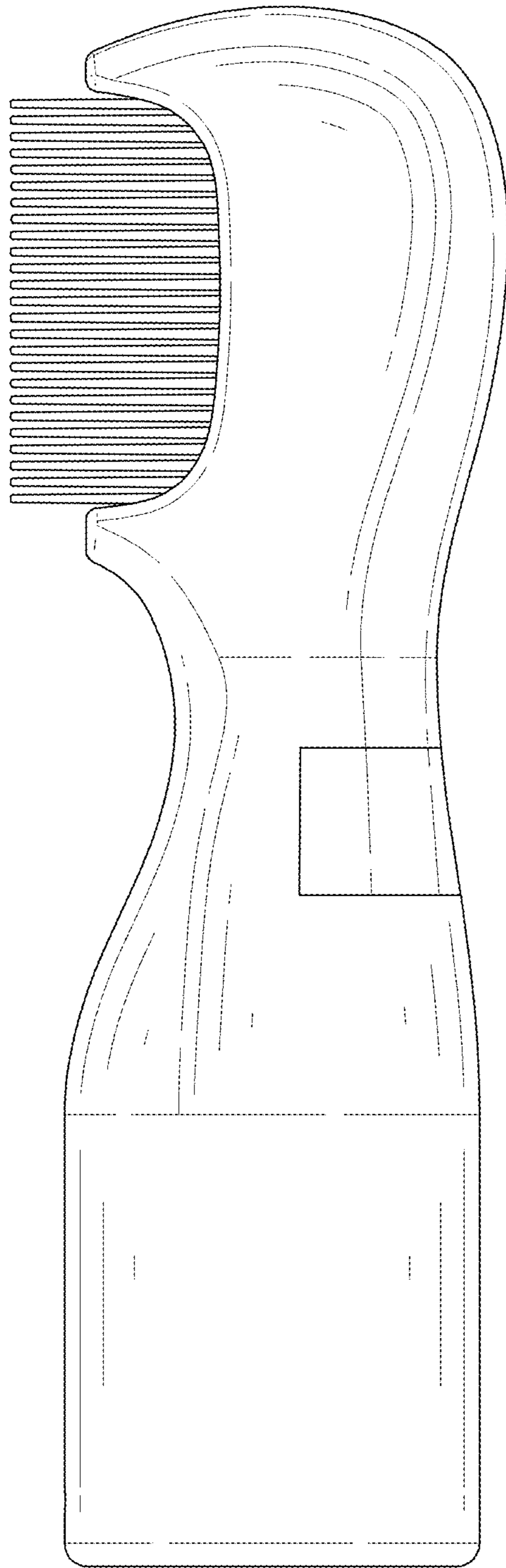

FIG. 3

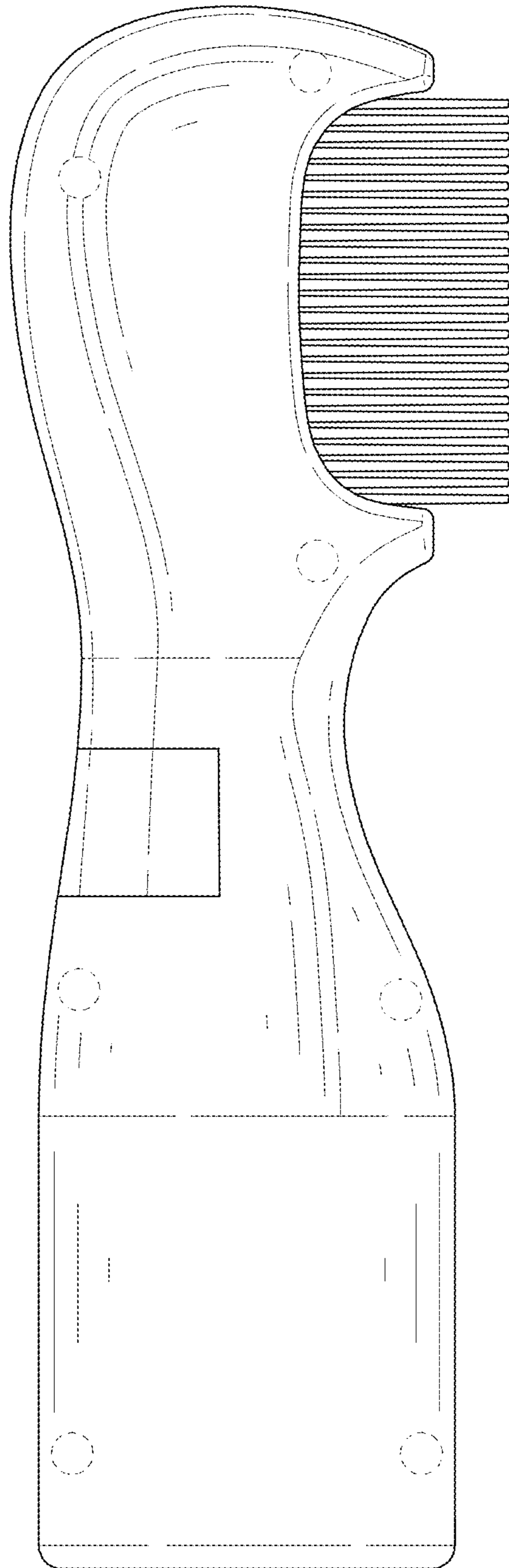

FIG. 4

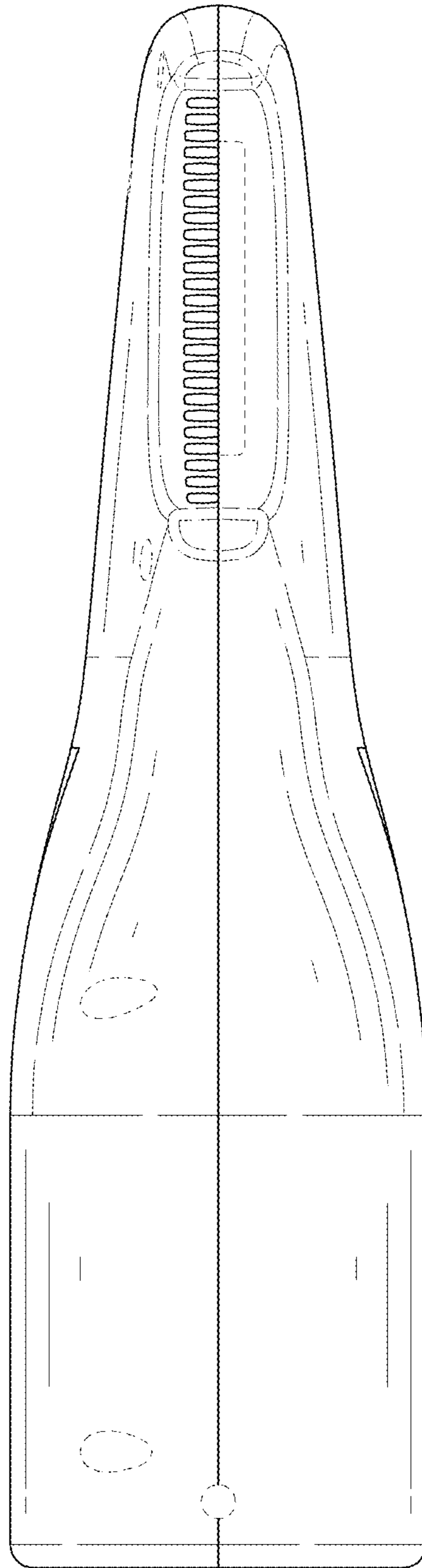

FIG. 5

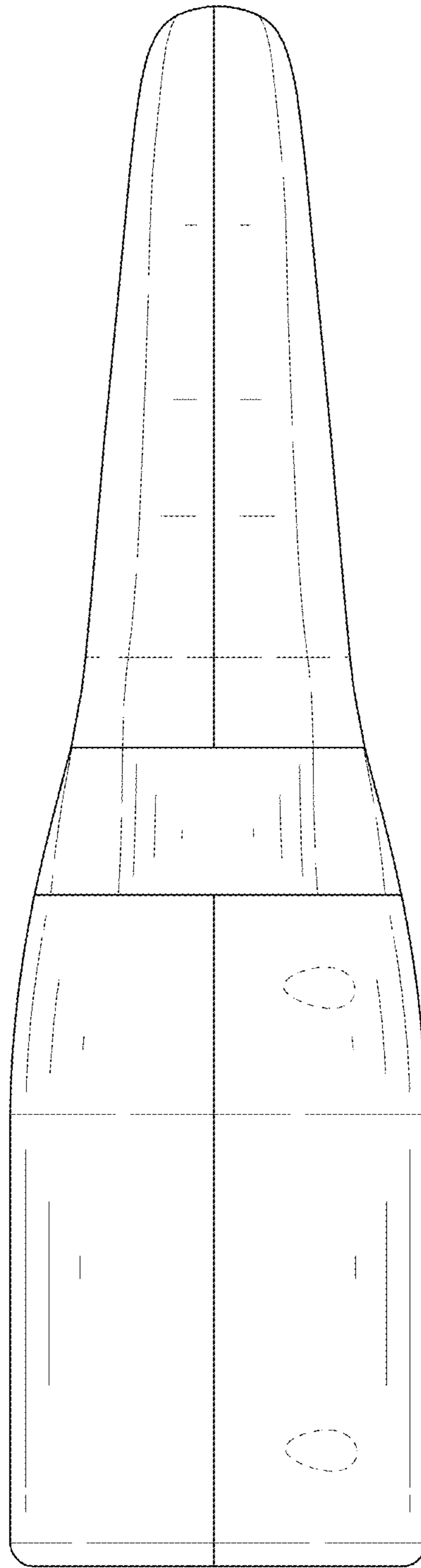

FIG. 6

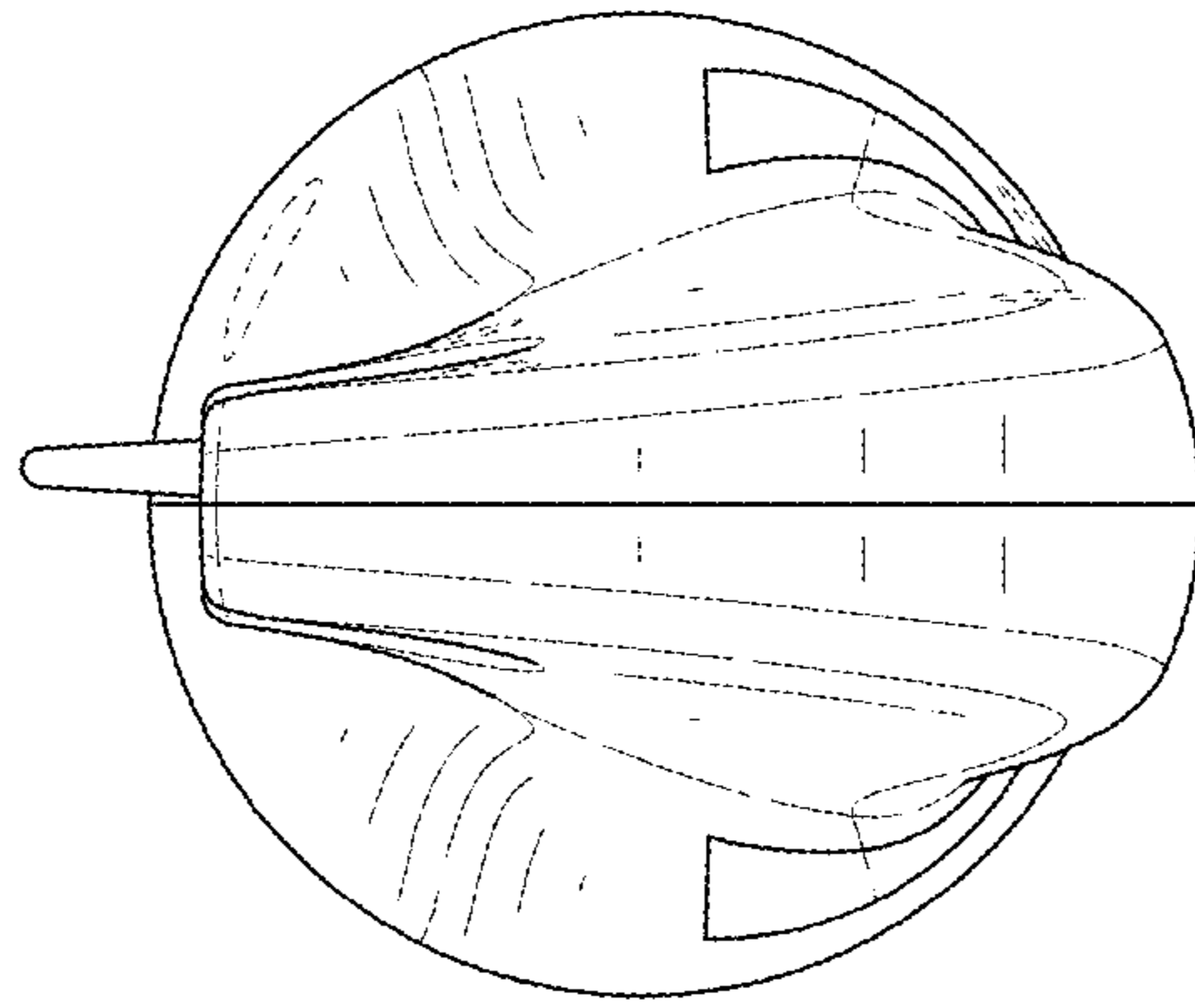

FIG. 7



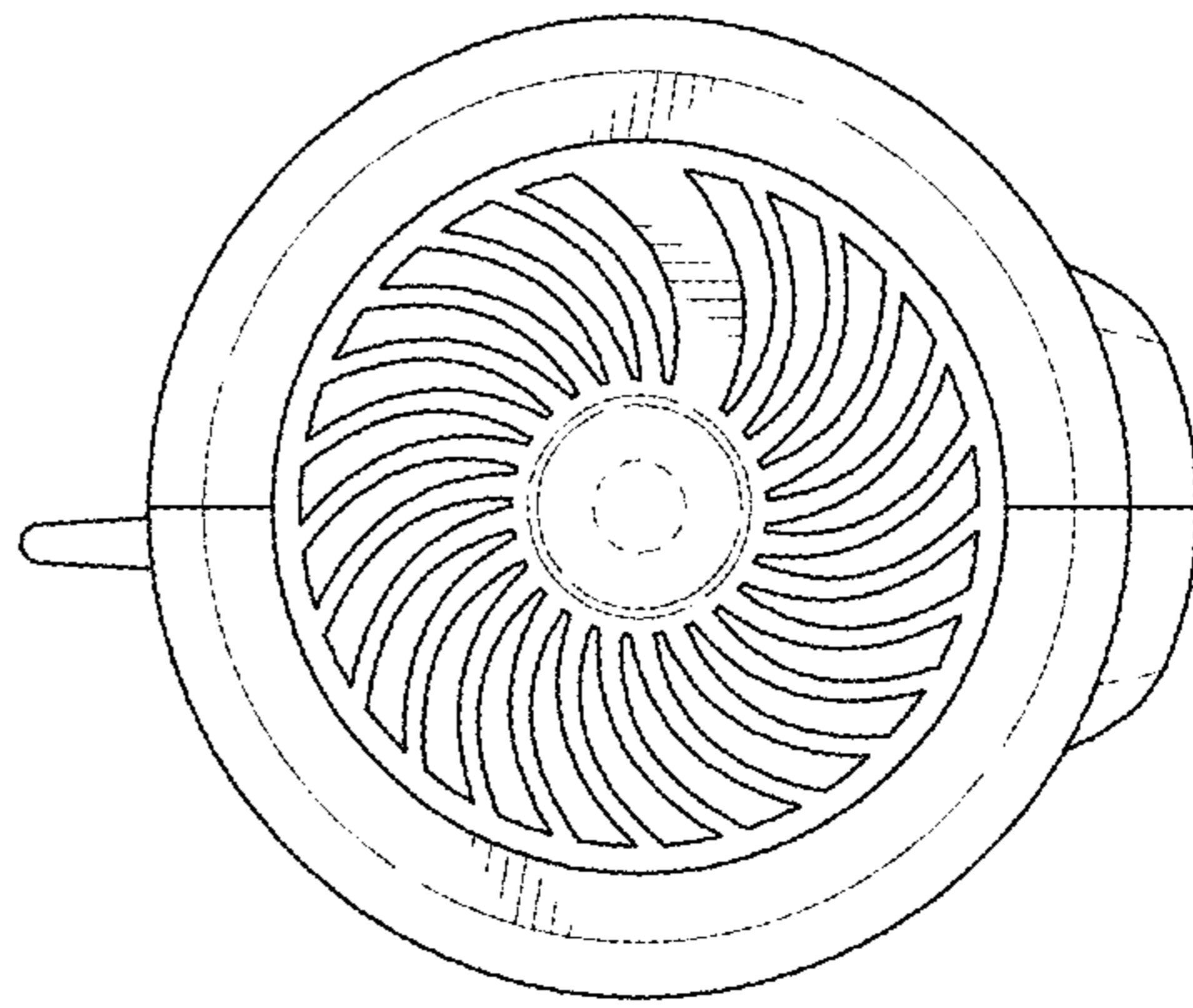

FIG. 8