



US00D935682S

(12) **United States Design Patent**
Wang

(10) **Patent No.:** **US D935,682 S**

(45) **Date of Patent:** **** Nov. 9, 2021**

(54) **ARTIFICIAL GARLAND WITH MICRO LED**

Primary Examiner — Elizabeth J Oswecki

(71) Applicant: **Taizhou Fengdi Import and Export Co., Ltd.**, Taizhou (CN)

(72) Inventor: **Hailang Wang**, Taizhou (CN)

(**) Term: **15 Years**

(21) Appl. No.: **29/768,726**

(22) Filed: **Feb. 1, 2021**

(51) **LOC (13) Cl.** **26-03**

(52) **U.S. Cl.**

USPC **D26/101**; D26/25; D11/119

(58) **Field of Classification Search**

USPC D11/117, 118, 121, 125, 131, 157;
D26/24, 93, 94, 101, 110

CPC A47G 33/04; A47G 33/06; A47G
2033/0827; F21S 6/00; F21S 6/002; F21S
8/036; F21V 21/02; F21V 21/10; F21W
2121/00

See application file for complete search history.

(56) **References Cited**

U.S. PATENT DOCUMENTS

D49,716 S *	9/1916	Urbanowicz	D6/304
D143,745 S *	2/1946	Miller	D6/302
2,565,700 A *	8/1951	Schiller	A47F 5/04
				428/19
3,253,137 A *	5/1966	Richter, III	F21V 3/023
				362/293
D276,962 S *	1/1985	Moore	D11/118
D325,885 S *	5/1992	Small	D11/115
D402,774 S *	12/1998	Segal	D26/25

(Continued)

OTHER PUBLICATIONS

Lighted Garland 6FT 60 LED Lights, Battery Operated Silver Wrapped, [\(Continued\)](https://www.save-on-crafts.com/products/lighted-garland-6ft-60-led-lights-battery-operated-silver-wrapped?variant=31602657820803&msclkid=df3395572c88116467eaf5f3bc682900&utm_source=bing&utm_medium=cpc&utm_campaign=SOC-Shopping, 2021 (Year: 2021).*</p></div>
<div data-bbox=)

(57) **CLAIM**

The ornamental design for an artificial garland with micro LED, as shown and described.

DESCRIPTION

FIG. 1 is a front perspective view of an artificial garland with micro LED, showing my new design;
 FIG. 2 is a rear perspective view thereof;
 FIG. 3 is a front elevation view thereof;
 FIG. 4 is a rear elevation view thereof;
 FIG. 5 is a left side elevation view thereof;
 FIG. 6 is a right side elevation view thereof;
 FIG. 7 is a top plan view thereof;
 FIG. 8 is a bottom plan view thereof;
 FIG. 9 is an enlarged view of a portion labeled, 'FIG. 9' in FIG. 1;
 FIG. 10 is an enlarged view of a portion labeled, 'FIG. 10' in FIG. 5;
 FIG. 11 is an enlarged view of a portion labeled, 'FIG. 11' in FIG. 5;
 FIG. 12 is an enlarged view of a portion labeled, 'FIG. 12' in FIG. 6;
 FIG. 13 is an enlarged view of a portion labeled, 'FIG. 13' in FIG. 6;
 FIG. 14 is an enlarged view of a portion labeled, 'FIG. 14' in FIG. 7;
 FIG. 15 is an enlarged view of a portion labeled, 'FIG. 15' in FIG. 8; and,
 FIG. 16 is another perspective view of the artificial garland with micro LED, shown in an used condition with leaves in broken lines.

The dash dot dash lines in FIGS. 1 and 5-15 are for the purpose of depicting the cut line of the enlarged view and form no part of the claim. The even broken lines in FIG. 16 showing of a leaves depict environmental structure that form no part of the claimed design.

1 Claim, 16 Drawing Sheets

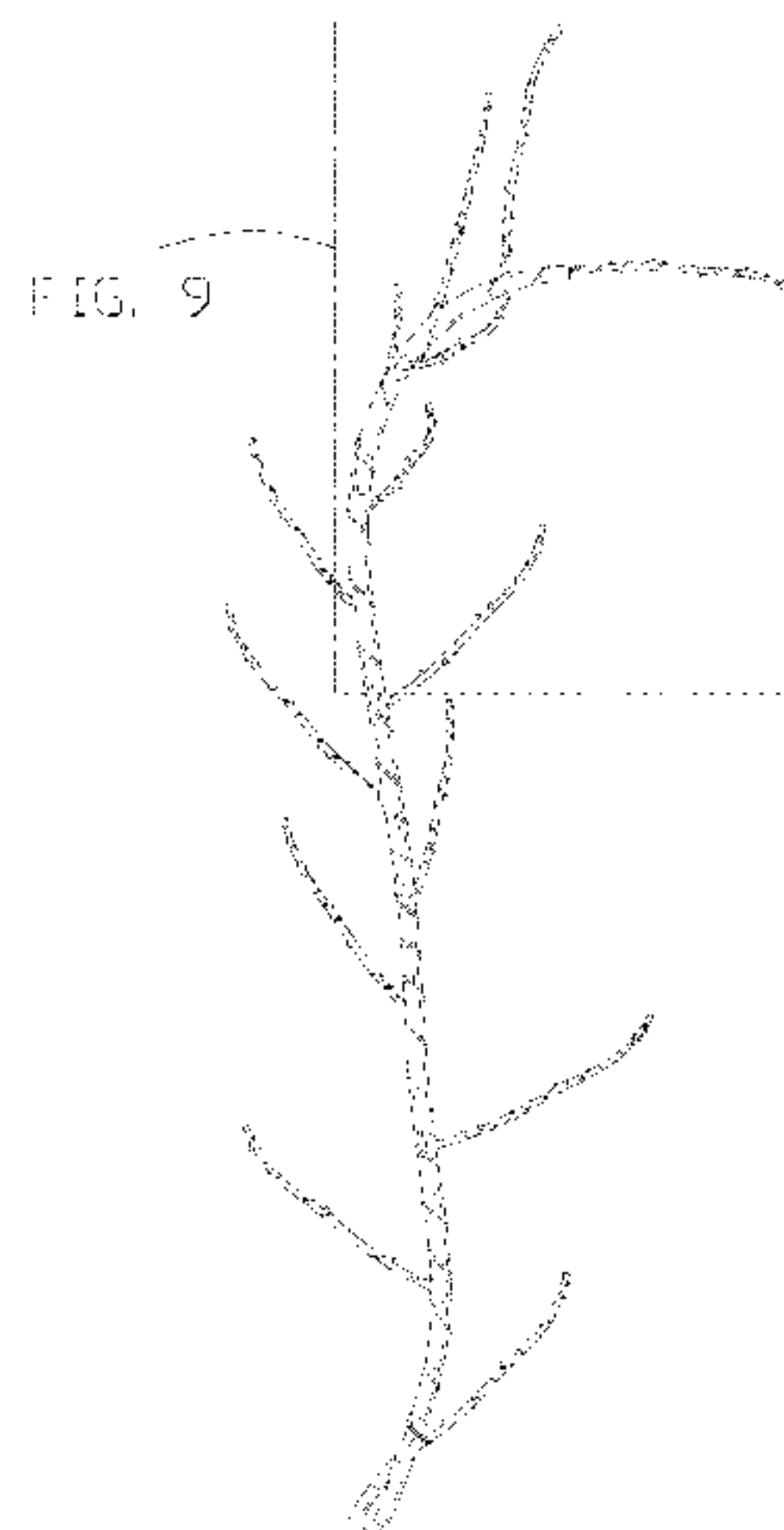

(56)

References Cited

U.S. PATENT DOCUMENTS

D460,719	S *	7/2002	Lewis	D11/118
D461,707	S *	8/2002	Kumar	D11/119
D475,320	S *	6/2003	Hensley	D11/118
D476,262	S *	6/2003	Hensley	D11/118
D476,755	S *	7/2003	LoVullo	D11/119
D507,989	S *	8/2005	Lamb	D11/118
D621,635	S *	8/2010	Murphy	D6/681.3
D655,834	S *	3/2012	Zhu	D26/25
D655,944	S *	3/2012	Malinski	D6/674
D691,295	S	10/2013	Chappey	
D830,719	S *	10/2018	Palumbo	D6/404
D831,372	S *	10/2018	Palumbo	D6/404
D894,784	S *	9/2020	Huang	D11/118
D896,689	S *	9/2020	Huang	D11/118
D917,771	S *	4/2021	Wang	D26/101
D919,162	S *	5/2021	Qu	D26/101
D919,873	S *	5/2021	Qu	D26/101
2011/0096546	A1 *	4/2011	Weiser	A41G 1/005 362/249.18

OTHER PUBLICATIONS

Lighted Willow Vine, <https://www.desertcart.ae/products/12533777-lighted-willow-vine>, 2021 (Year: 2021).*

* cited by examiner

FIG. 9

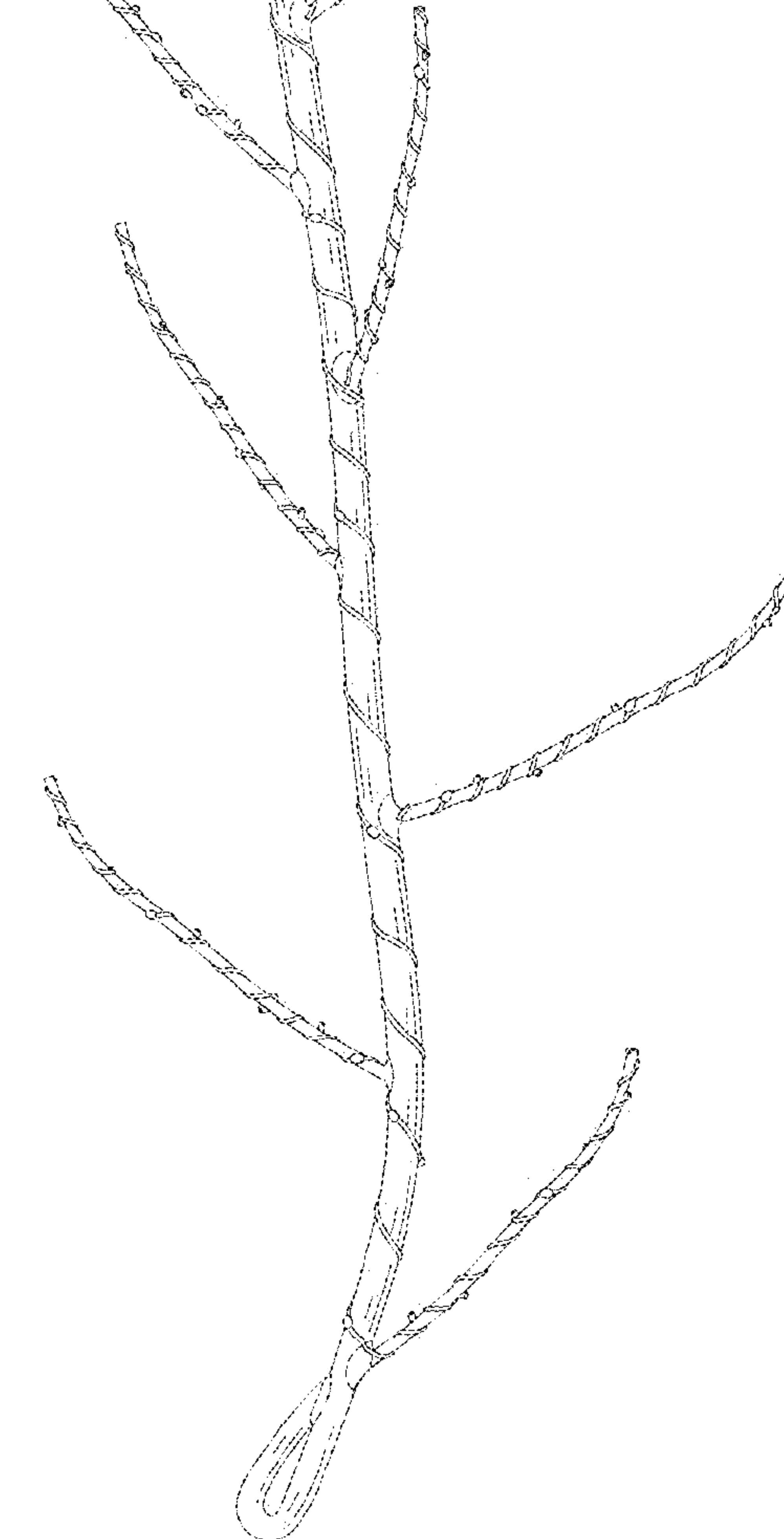
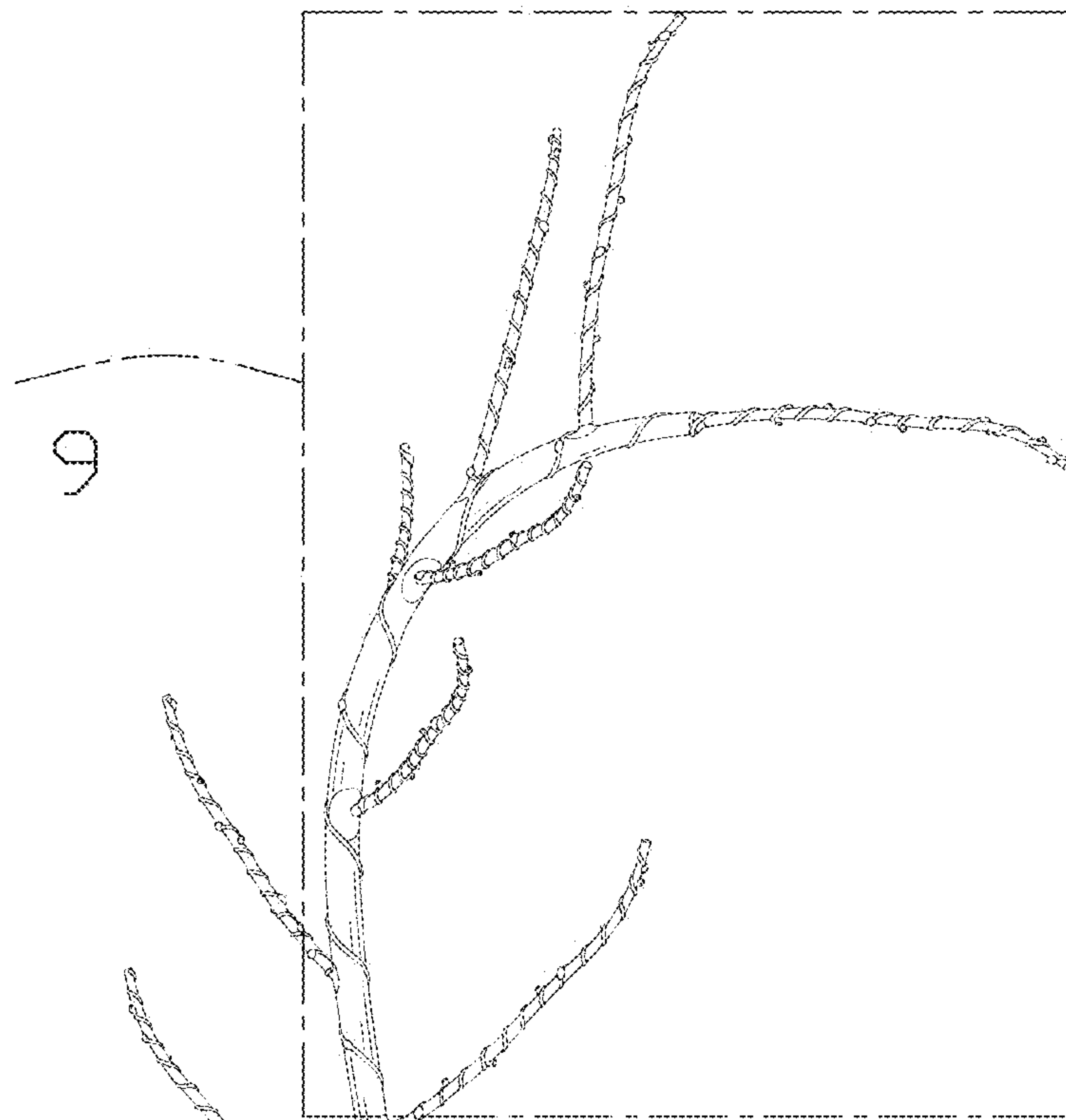

FIG. 1

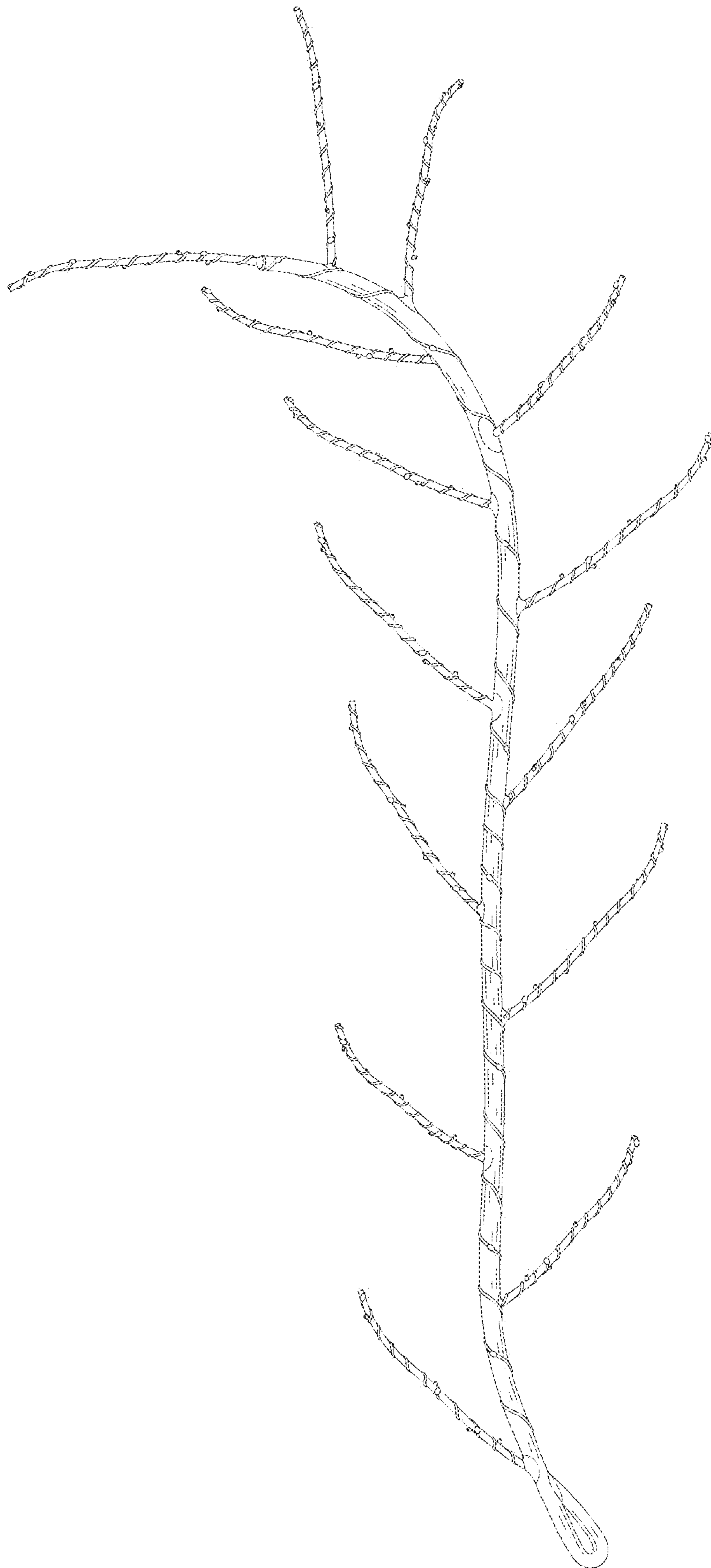

FIG. 2

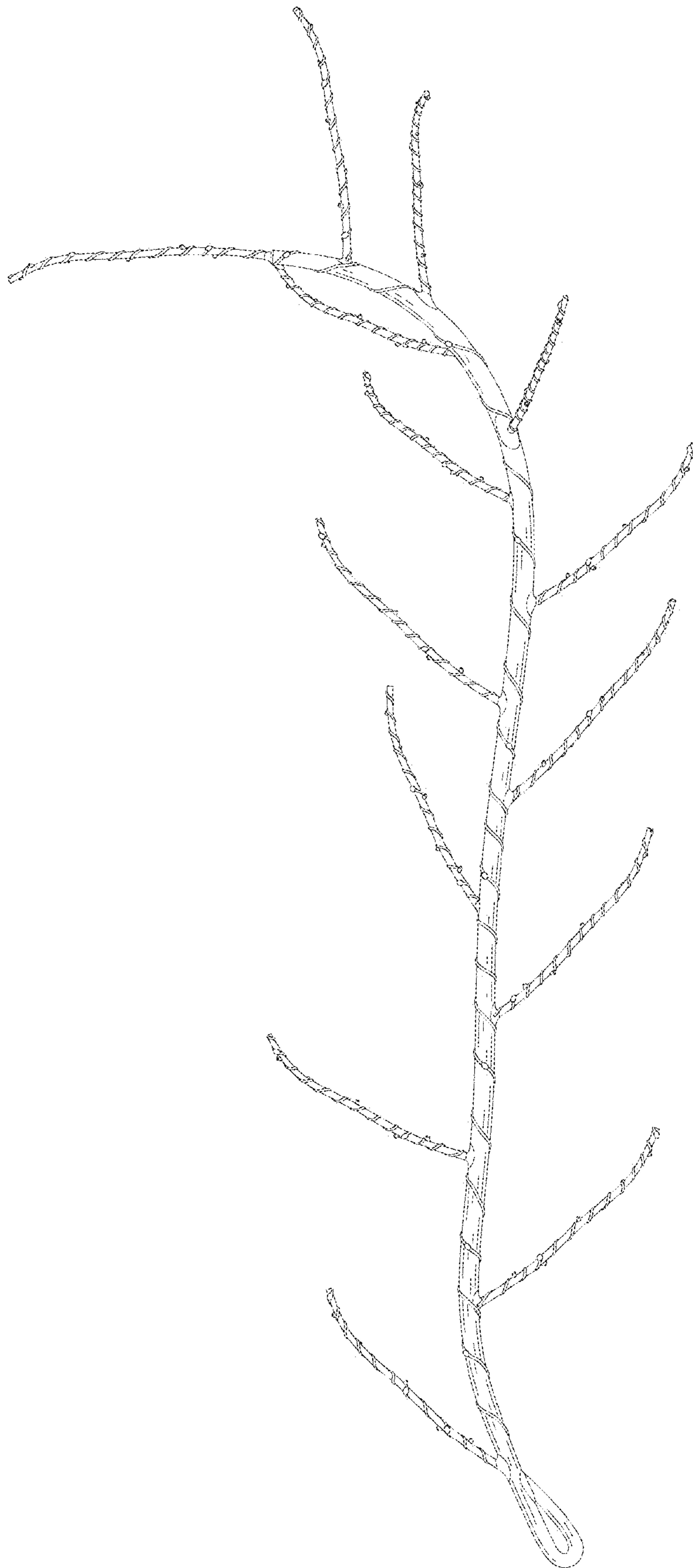

FIG. 3

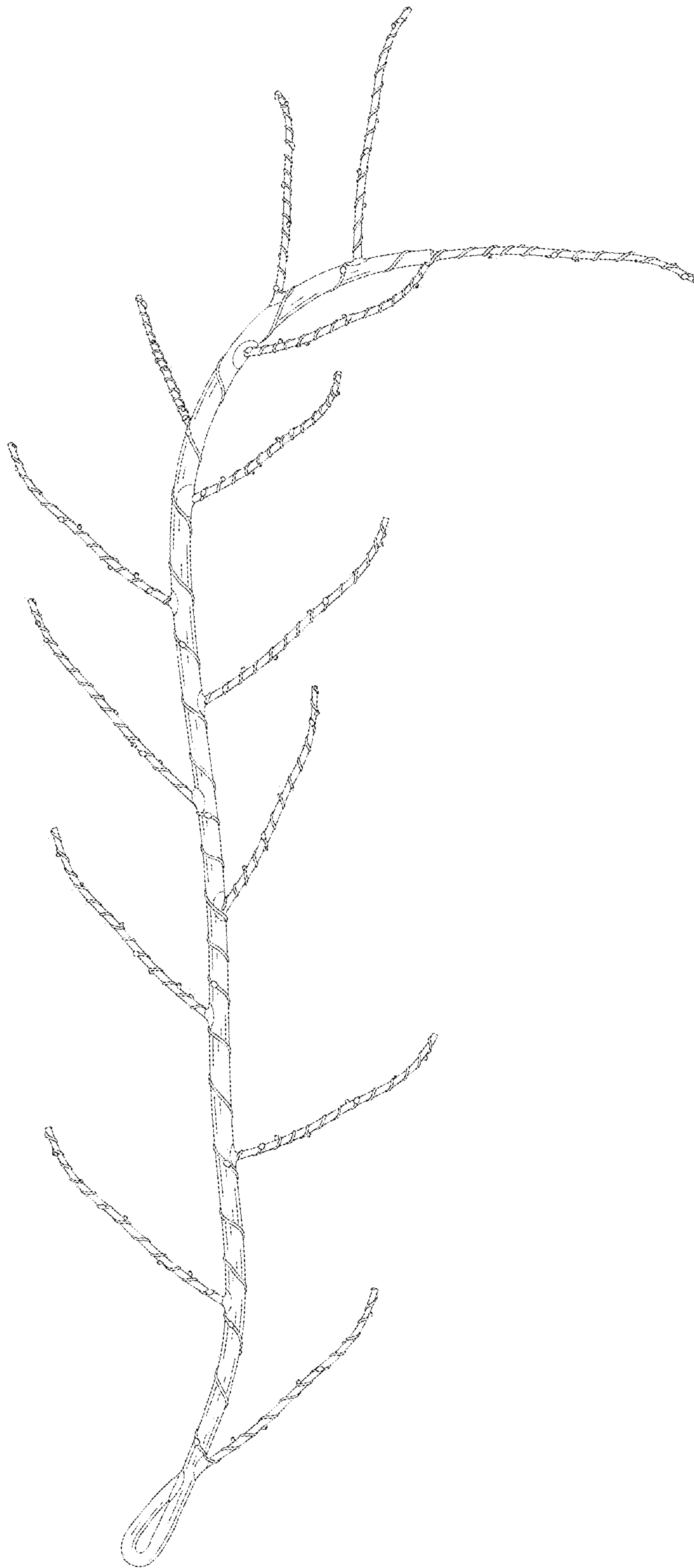
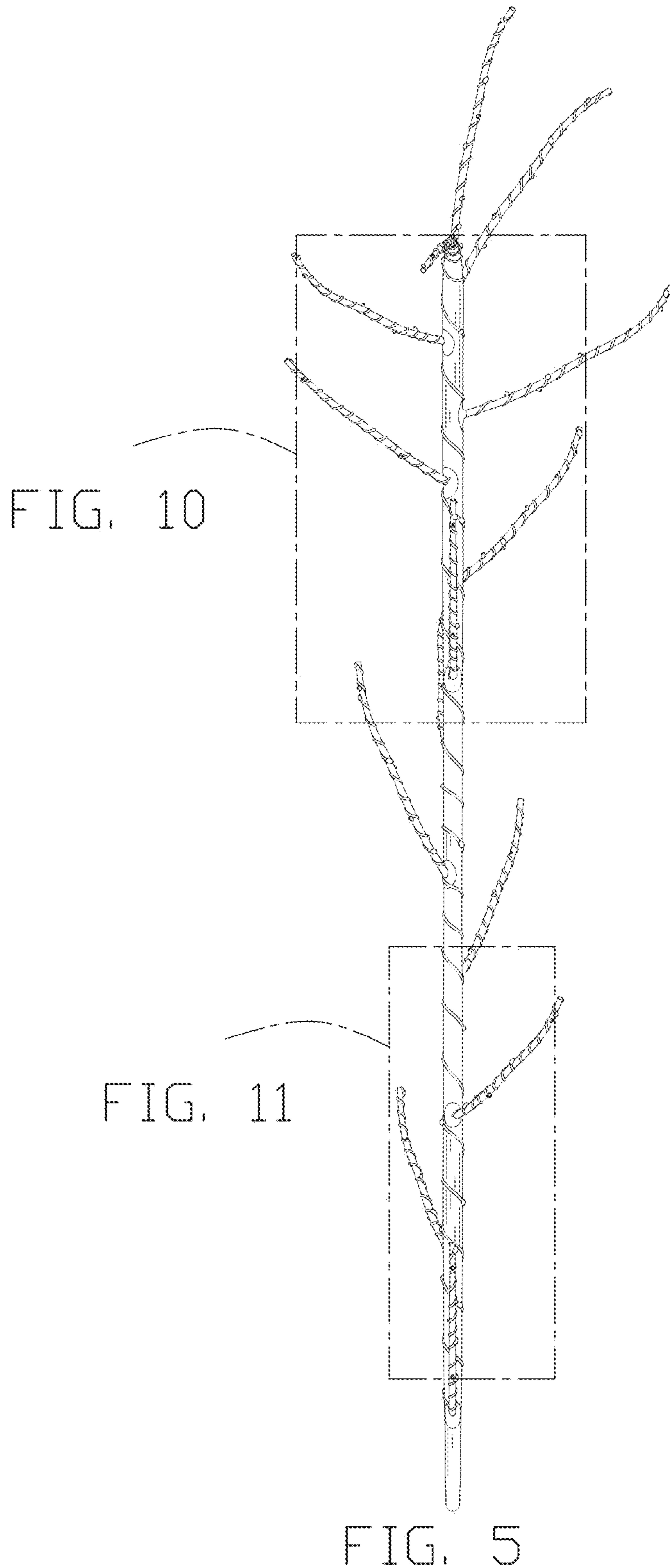
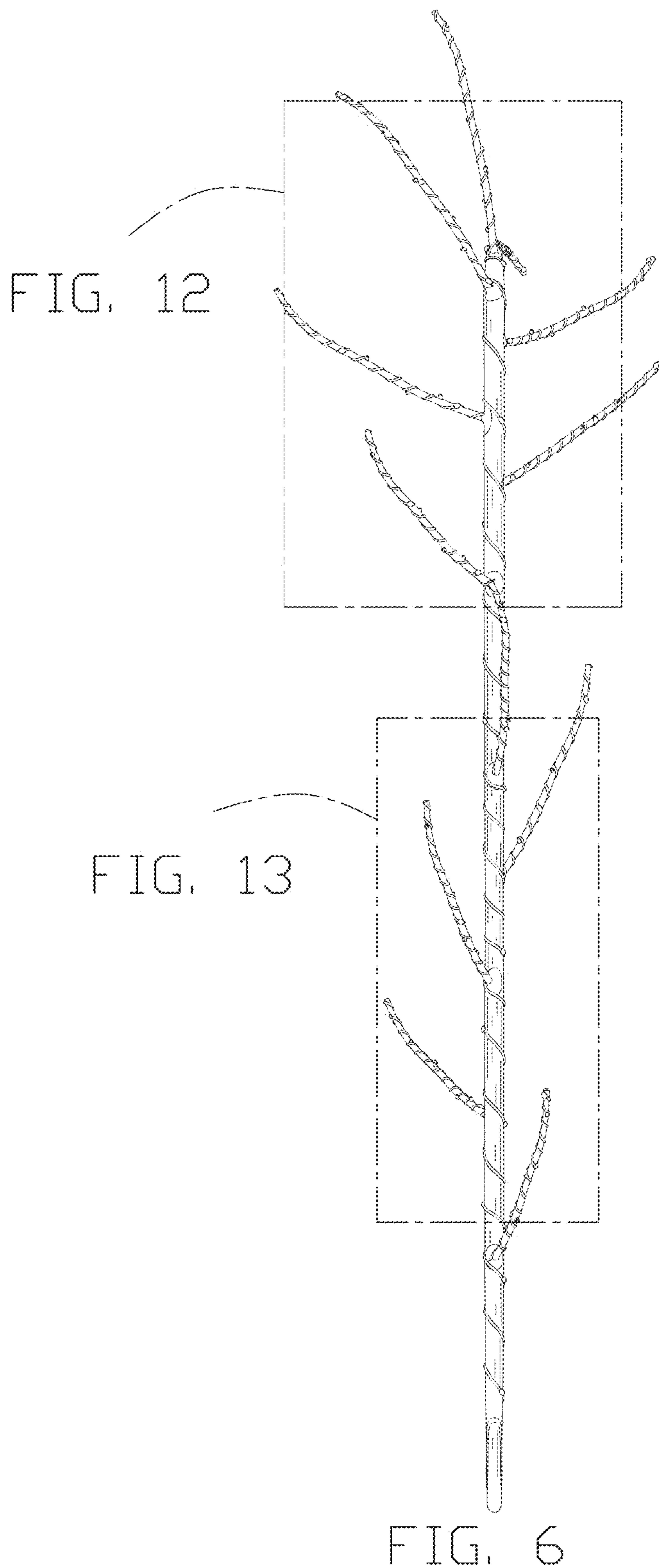

FIG. 4





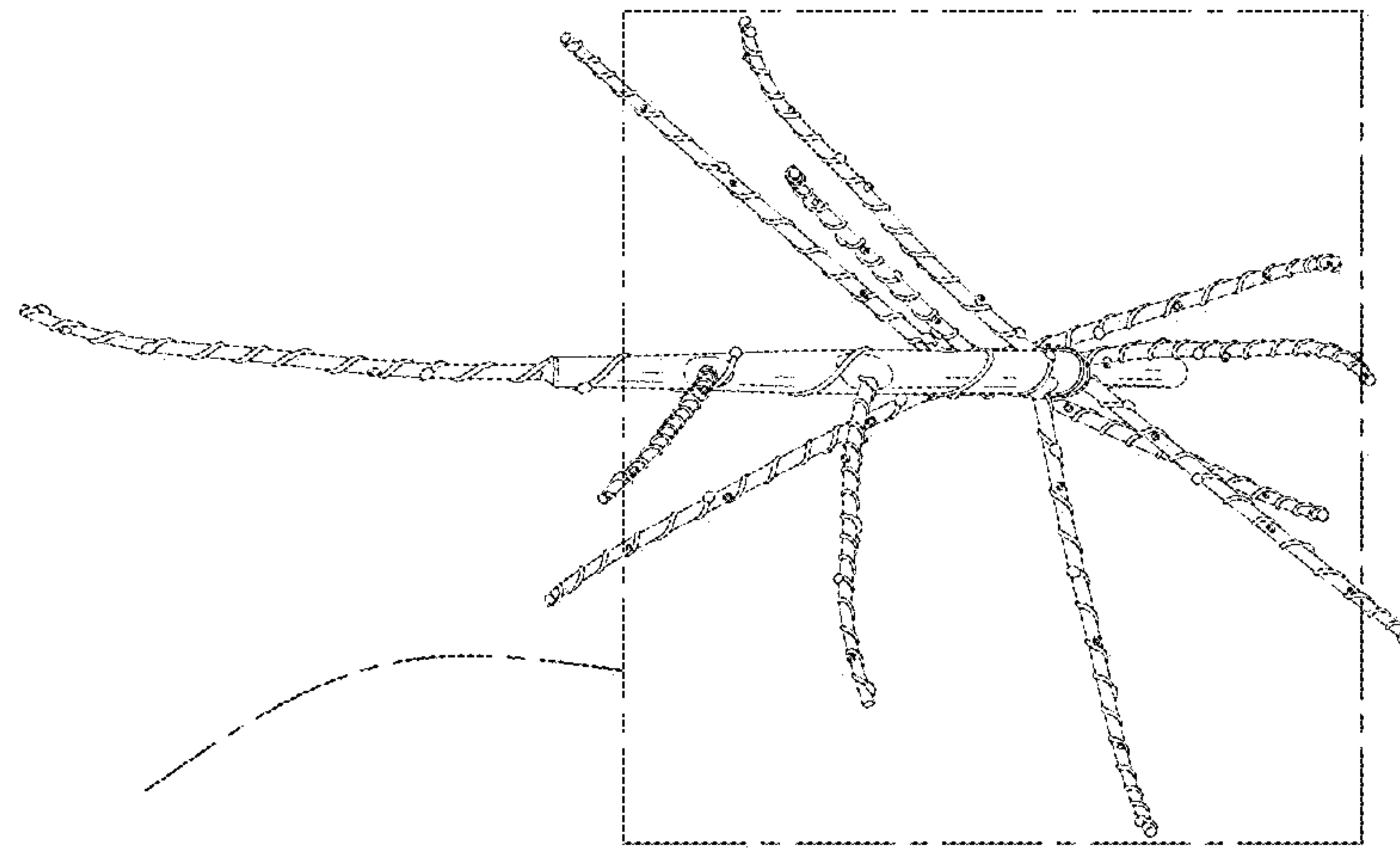

FIG. 14

FIG. 7

FIG. 15

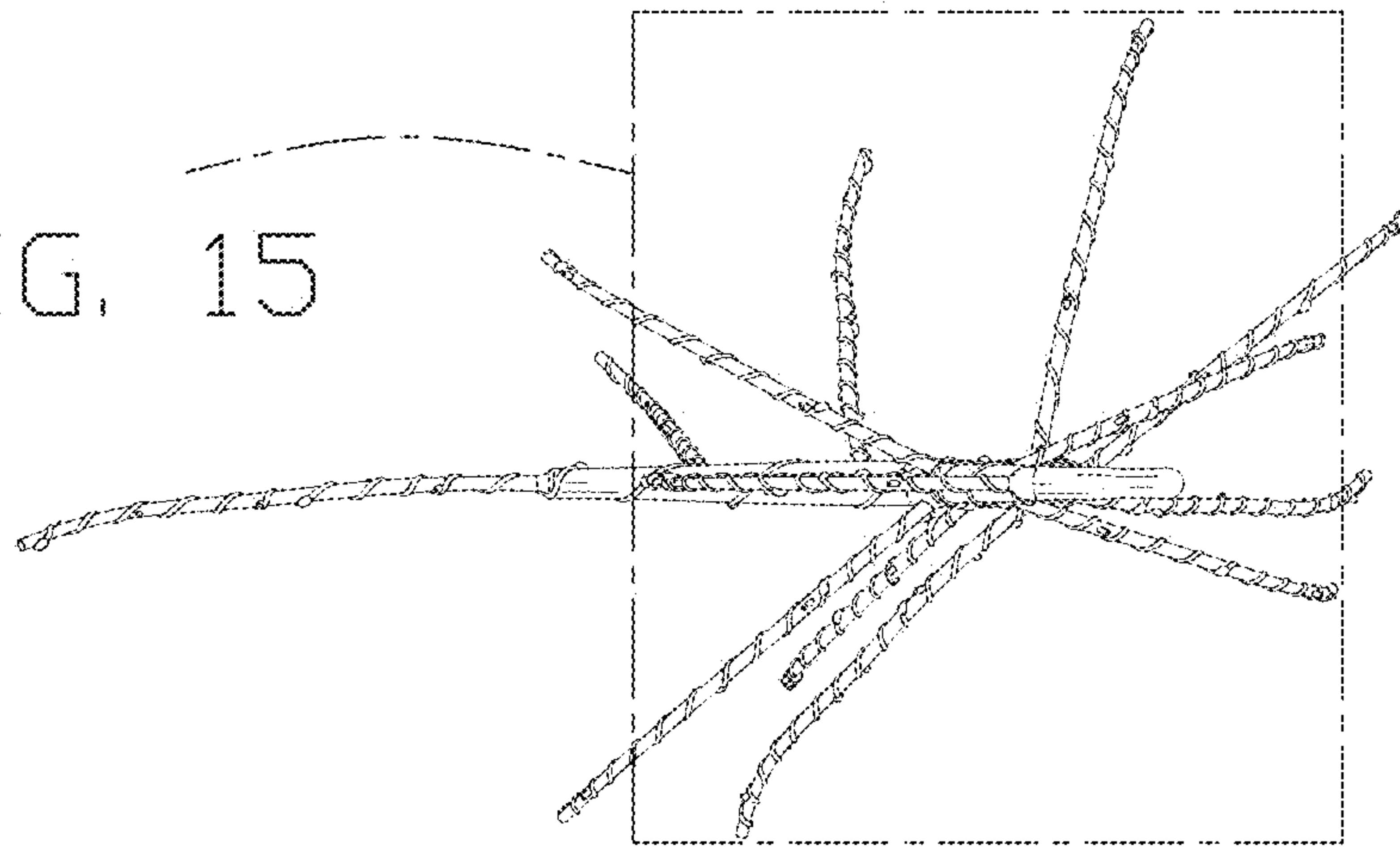

FIG. 8

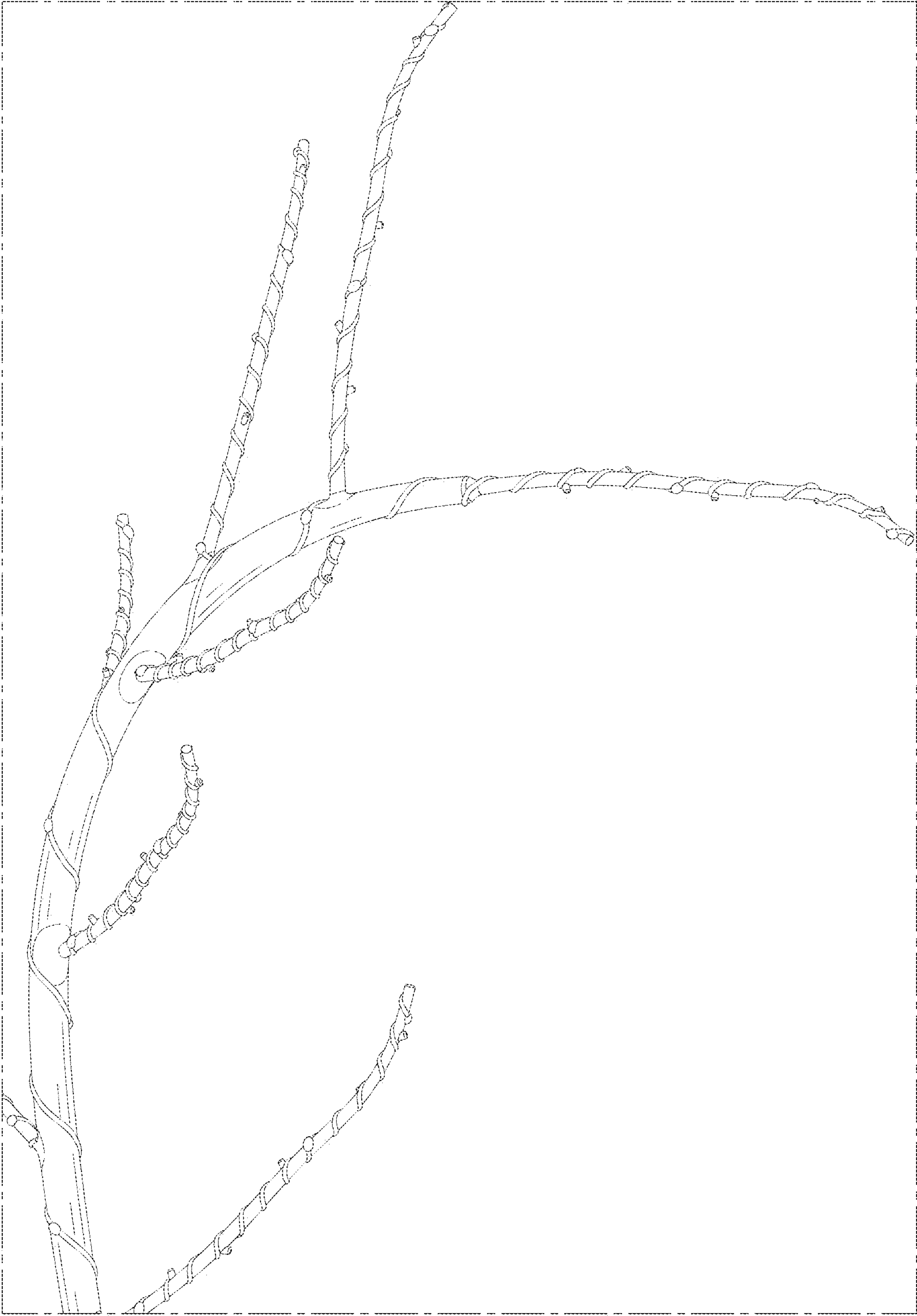

FIG. 9

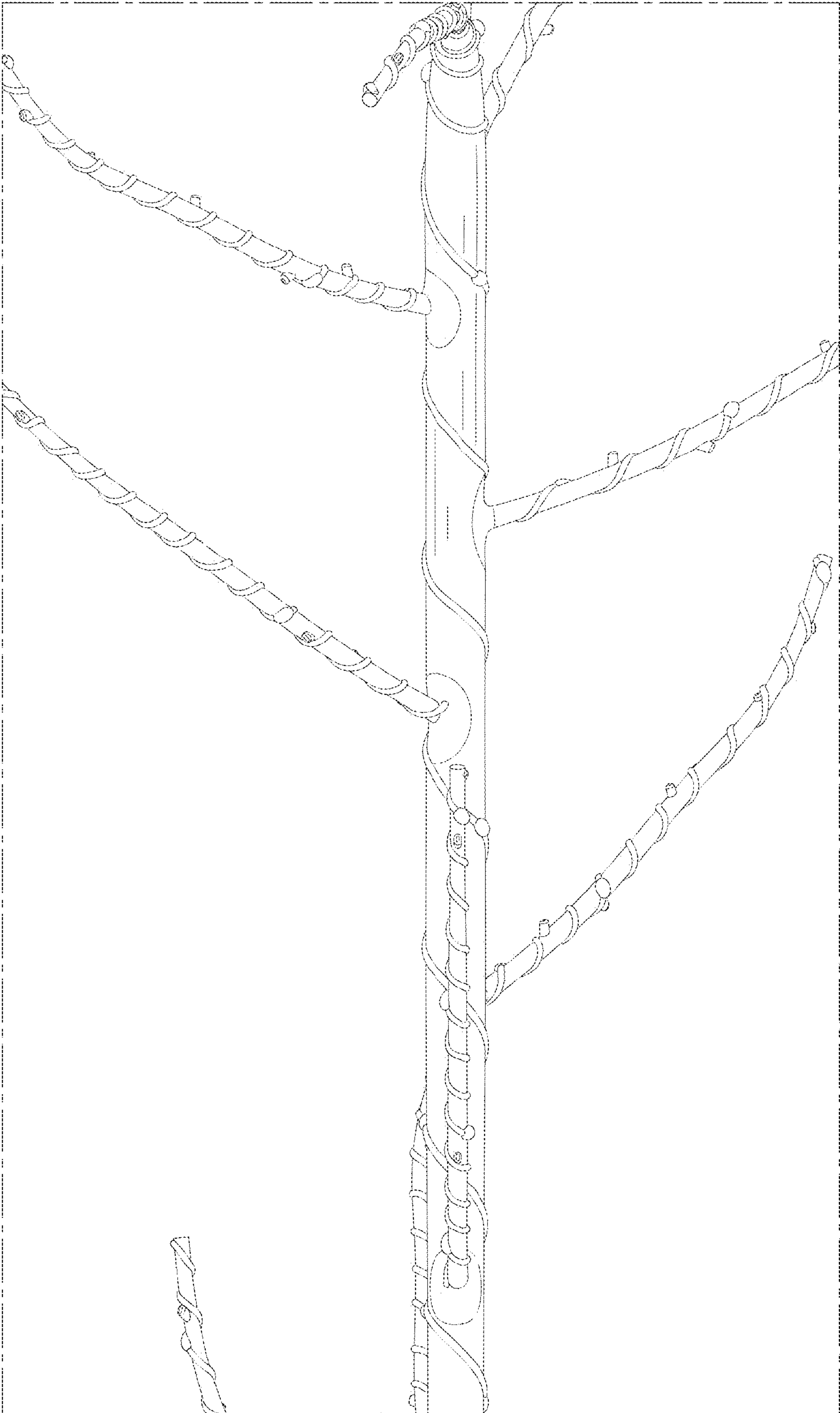

FIG. 10

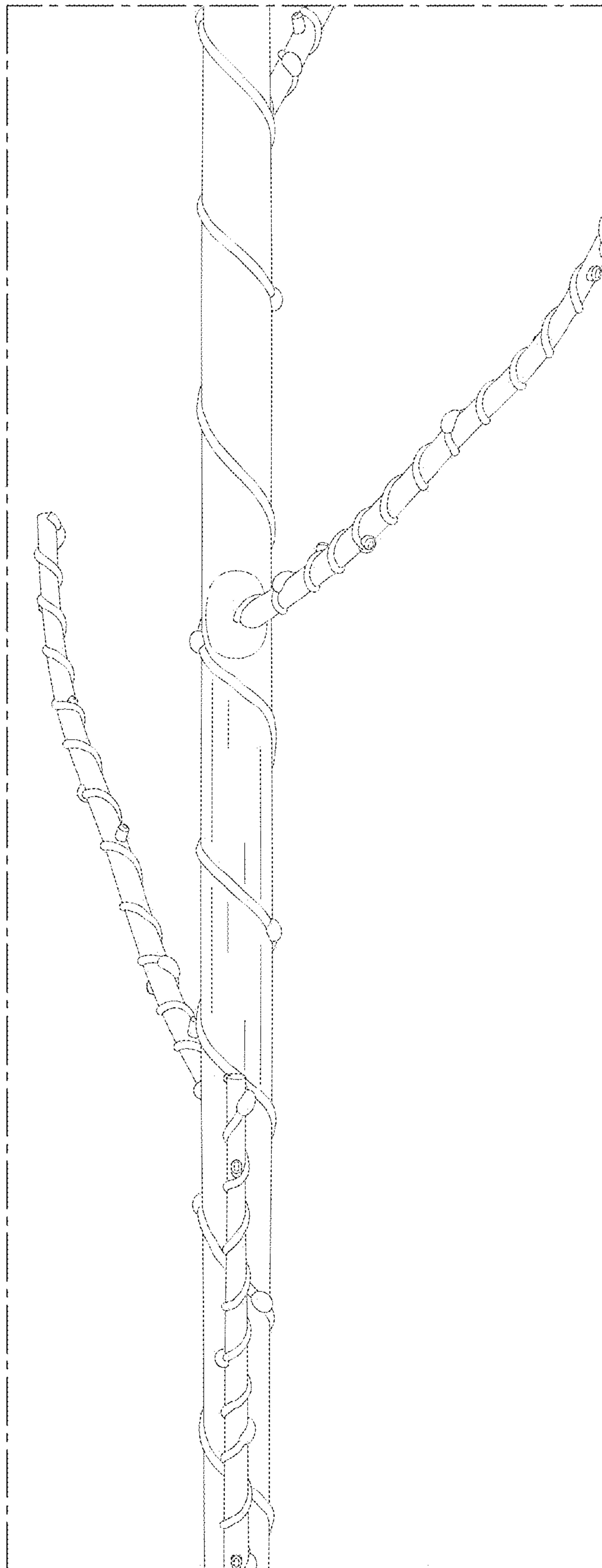

FIG. 11

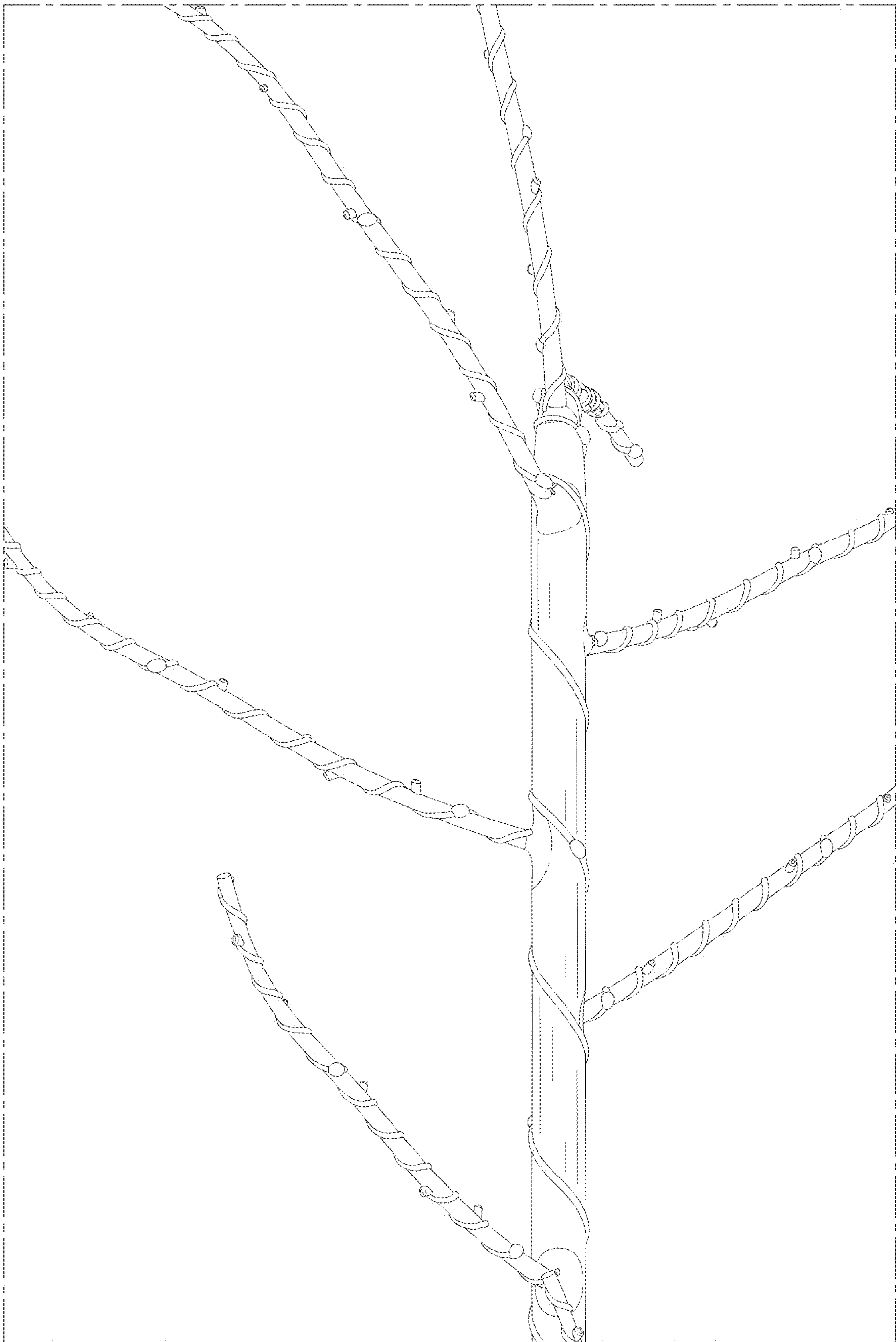

FIG. 12

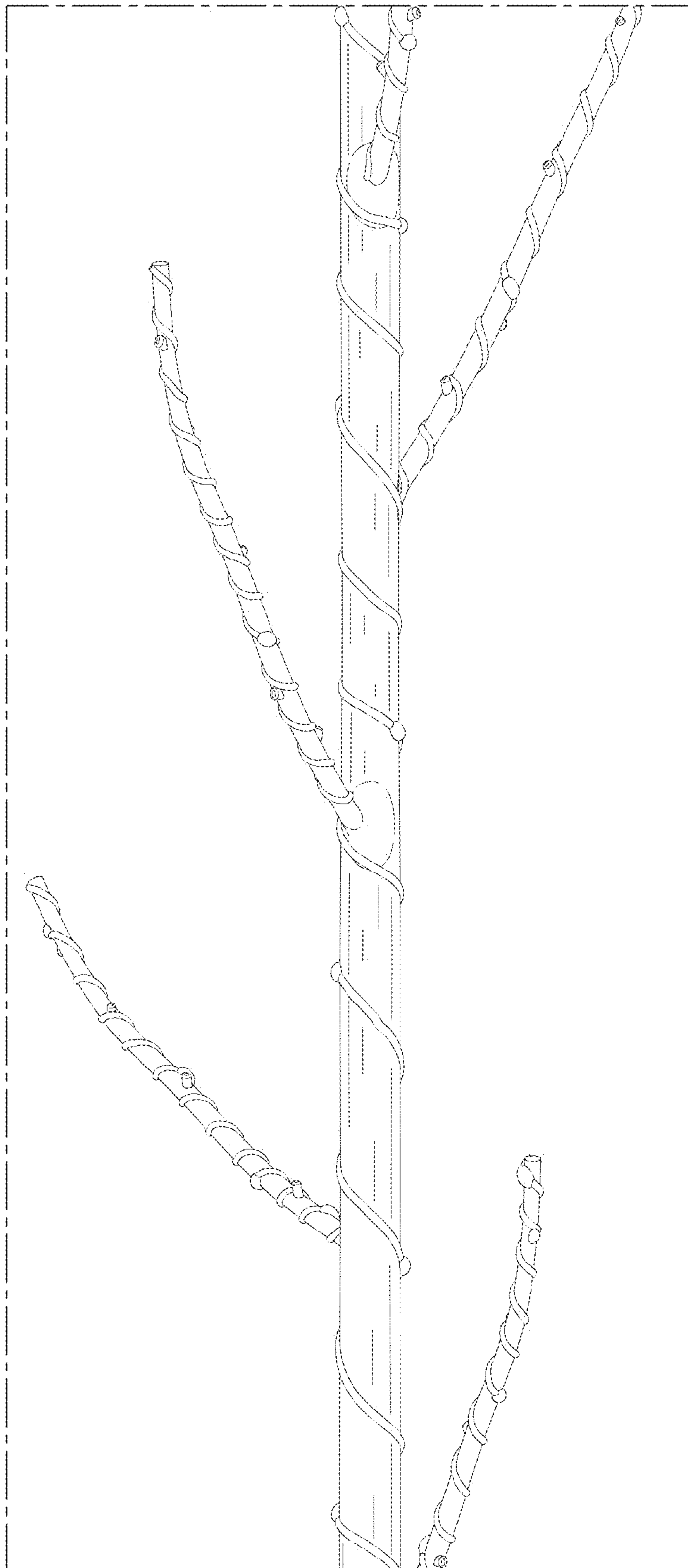

FIG. 13

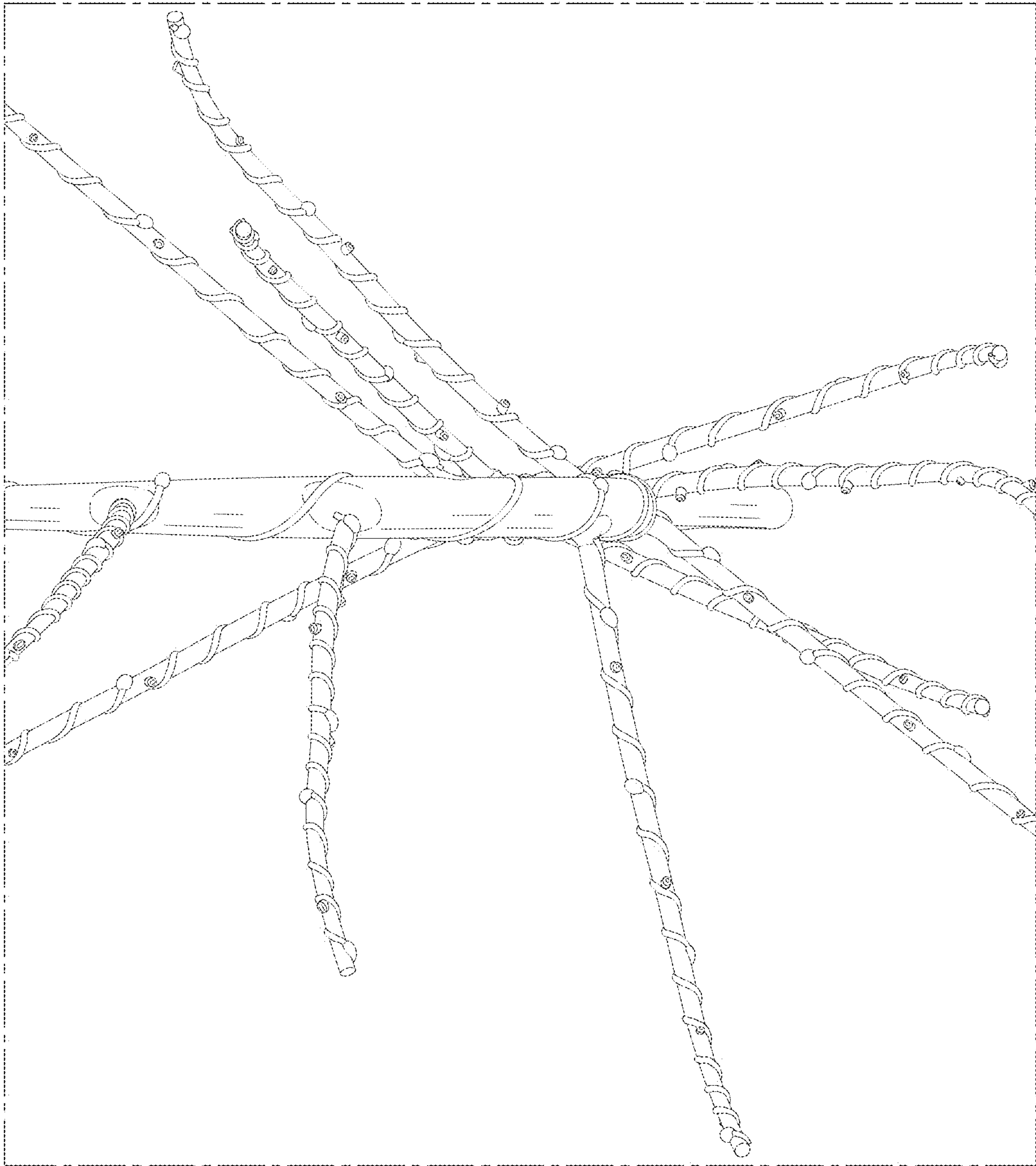

FIG. 14

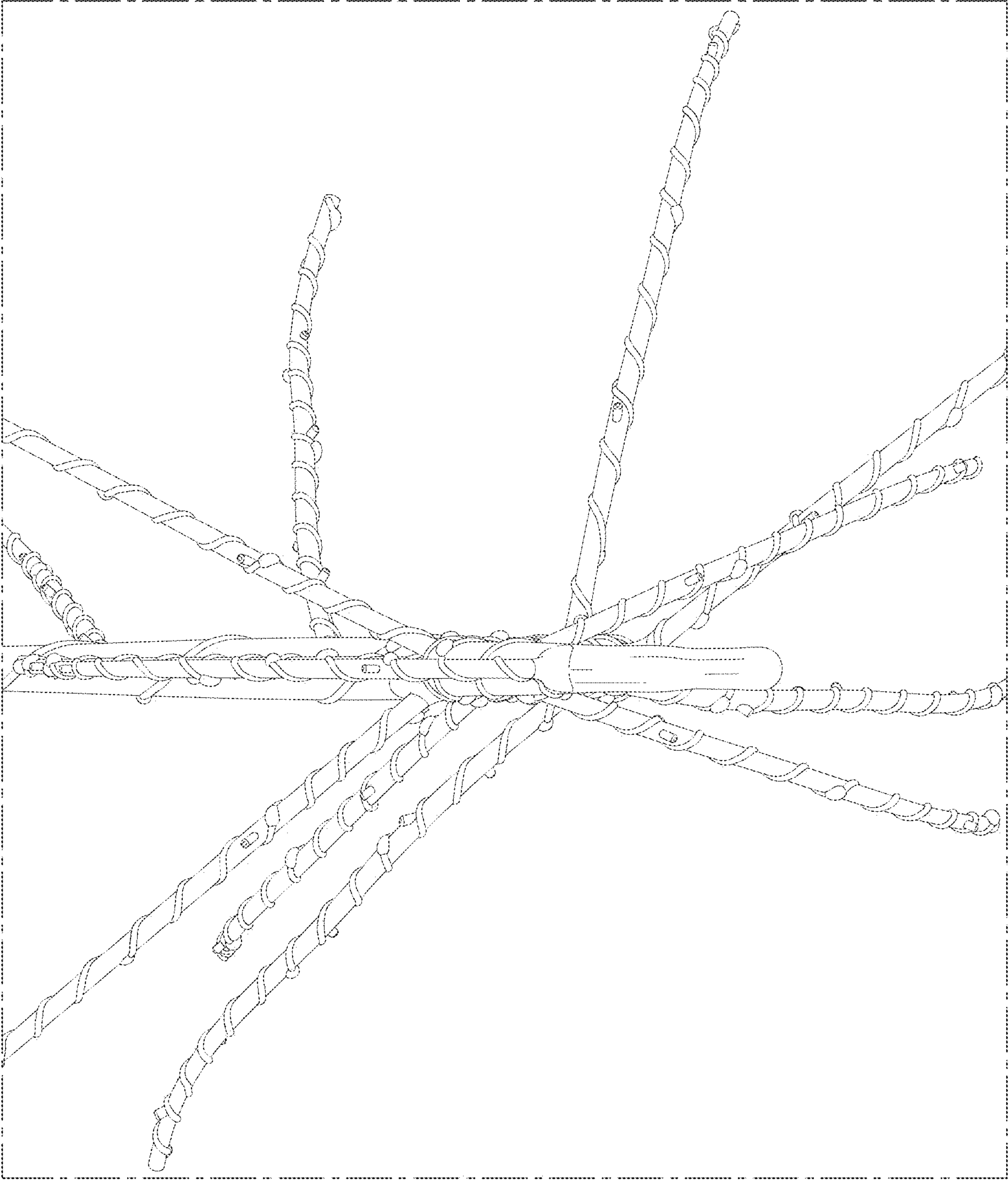

FIG. 15

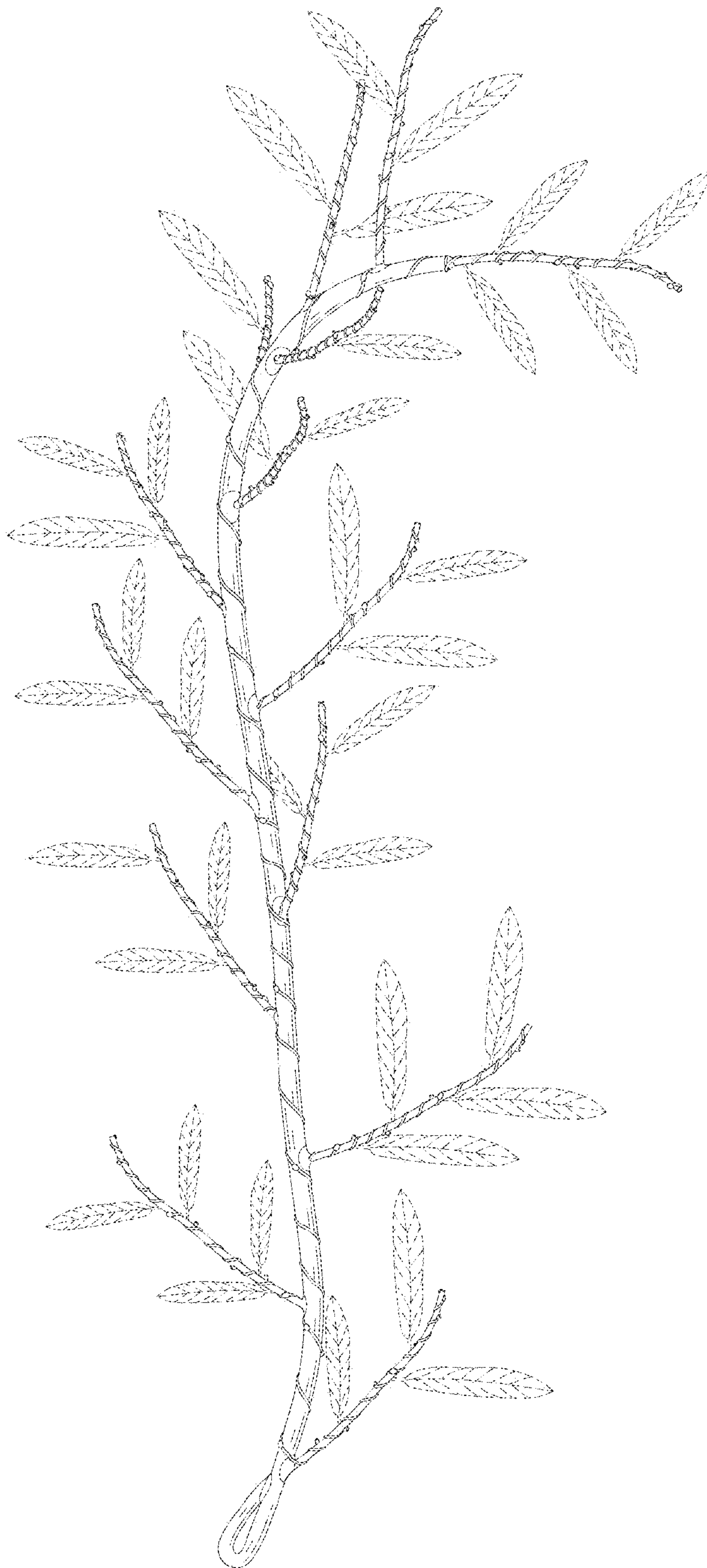

FIG. 16