



US00D935624S

(12) **United States Design Patent** (10) **Patent No.:** **US D935,624 S**
Soulet De Brugiere et al. (45) **Date of Patent:** **** Nov. 9, 2021**

(54) **ELECTRODE**
(71) Applicant: **DREEM**, Paris (FR)
(72) Inventors: **Quentin Soulet De Brugiere**, Paris (FR); **Martin Herrera**, Paris (FR); **Camille Kerbaul**, Paris (FR); **Pierre Emerich**, Paris (FR)

D756,524 S * 5/2016 Zhang D24/187
D797,297 S * 9/2017 Martin D24/187
D877,912 S * 3/2020 Ronan D24/167
D879,989 S * 3/2020 Mollohan D24/215
D892,340 S * 8/2020 Bishay D24/187
D895,797 S * 9/2020 Brockmann D24/133
2021/0044757 A1* 2/2021 Kuriyama A61B 1/00188

FOREIGN PATENT DOCUMENTS

(73) Assignee: **DREEM**, Paris (FR)
(**) Term: **15 Years**

RU 2019501248 * 1/2020

* cited by examiner

(21) Appl. No.: **29/692,111**
(22) Filed: **May 22, 2019**

Primary Examiner — Susan Bennett Hattan
Assistant Examiner — Omeed Agilee
(74) *Attorney, Agent, or Firm* — Volpe Koenig

(30) **Foreign Application Priority Data**

Apr. 12, 2019 (EM) 006376356-0001

(51) **LOC (13) Cl.** **24-02**
(52) **U.S. Cl.**
USPC **D24/187**

(58) **Field of Classification Search**
USPC D24/107, 164, 165–168, 186, 187, 189,
D24/200, 124, 215; D10/70, 75, 98;
D13/154, 156; D30/159
CPC A61B 5/0002; A61B 5/042; A61B 5/0404;
A61B 5/0416; A61B 5/0422; A61B
5/0424; A61B 5/0492; A61B 5/04004;
A61B 5/0402; A61B 5/04012; A61B
5/04082; A61B 5/04085; A61B 5/04087;
A61N 1/046; A61N 1/0472; A61N
1/0476; A61N 1/0492
See application file for complete search history.

(57) **CLAIM**

The ornamental design for an electrode, as shown and described.

DESCRIPTION

FIG. 1 is a front view of the electrode according to our new design;
FIG. 2 is a top view thereof;
FIG. 3 is a rear view thereof;
FIG. 4 is a top rear perspective view thereof;
FIG. 5 is a bottom front perspective view thereof;
FIG. 6 is a left side view thereof;
FIG. 7 is a right side view thereof; and,
FIG. 8 is a bottom view thereof.
The broken lines depict portions of the electrode that form no part of the claimed design.

(56) **References Cited**
U.S. PATENT DOCUMENTS

D638,131 S * 5/2011 Buckels D24/187
D723,705 S * 3/2015 Mininger D24/200

1 Claim, 8 Drawing Sheets

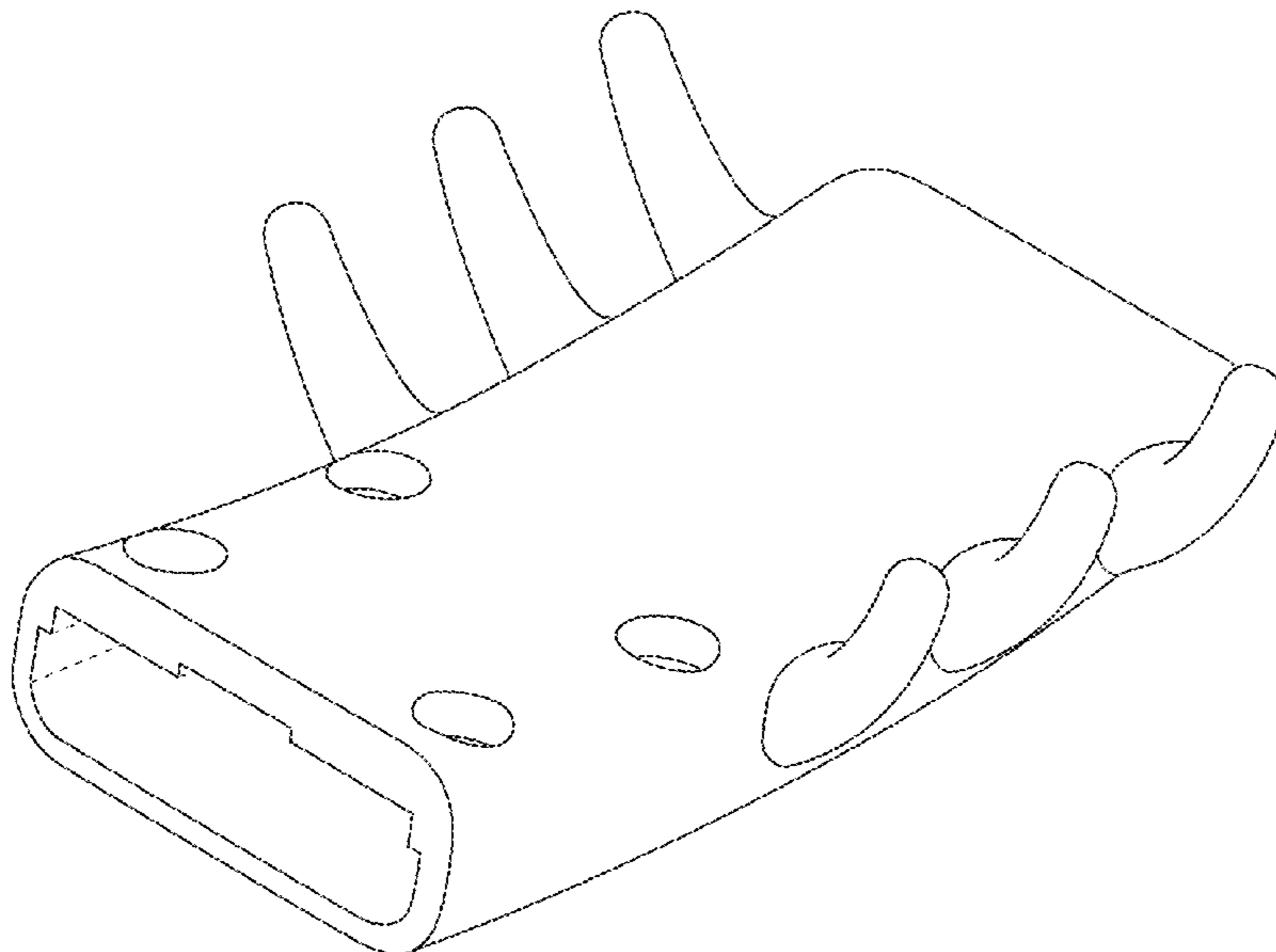

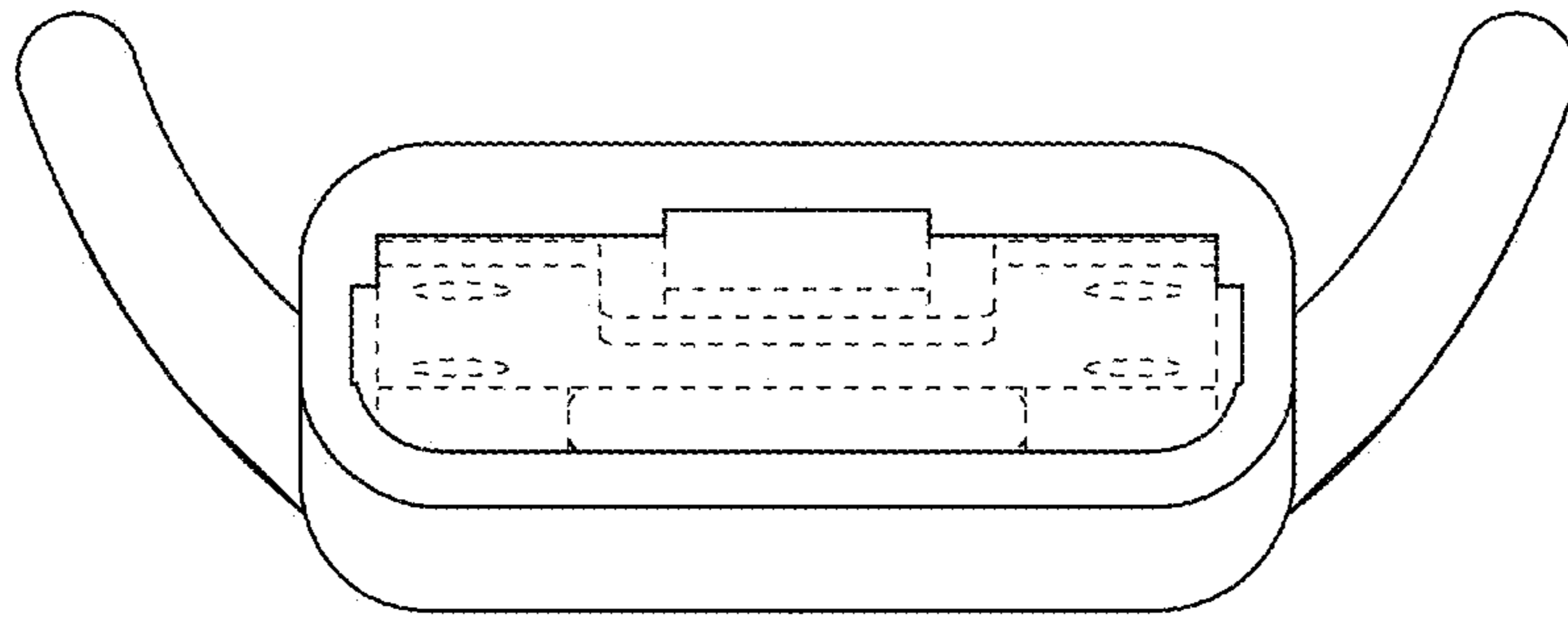

FIG. 1

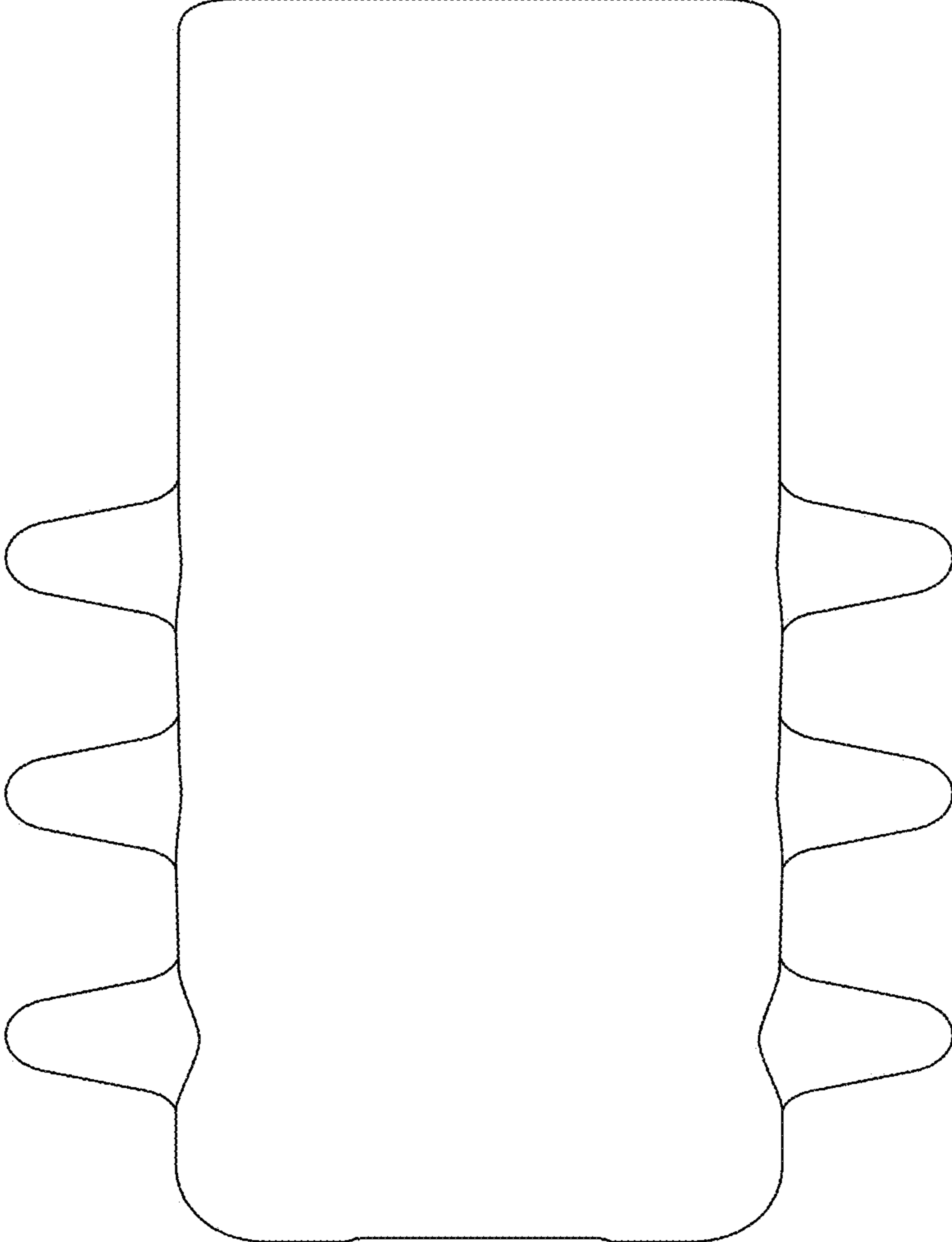

FIG. 2

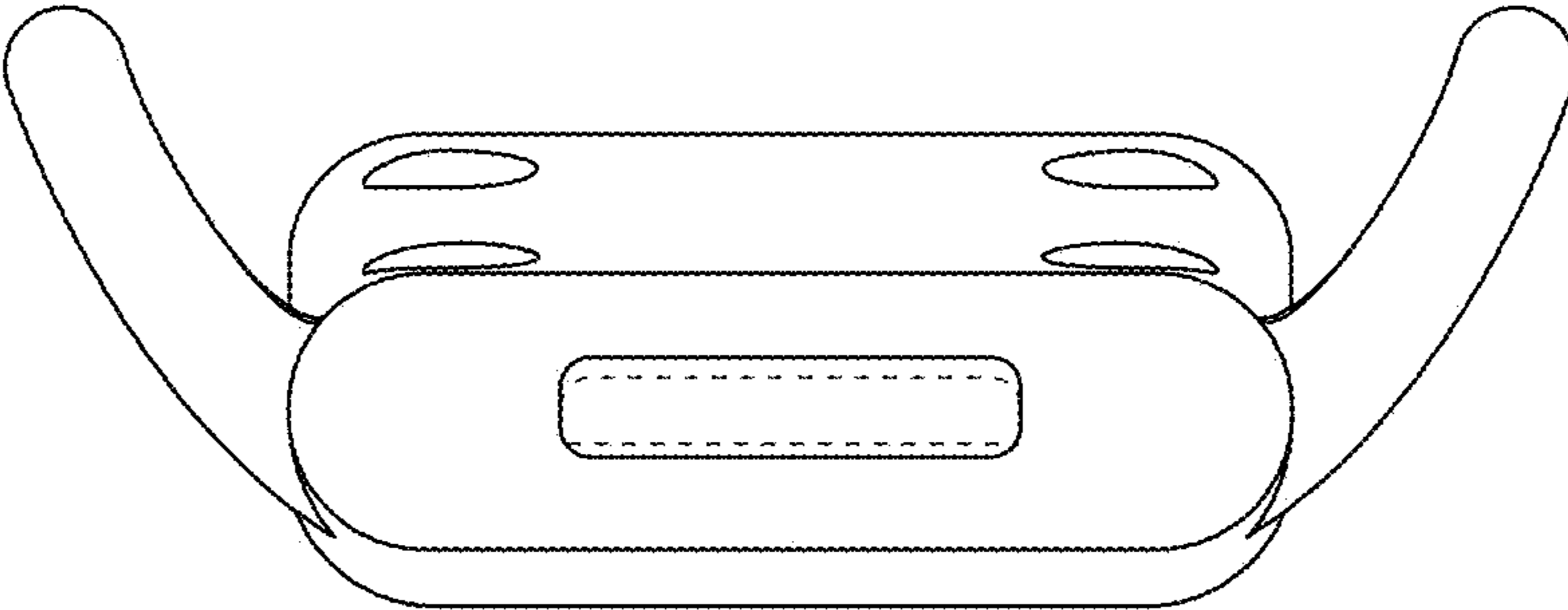

FIG. 3

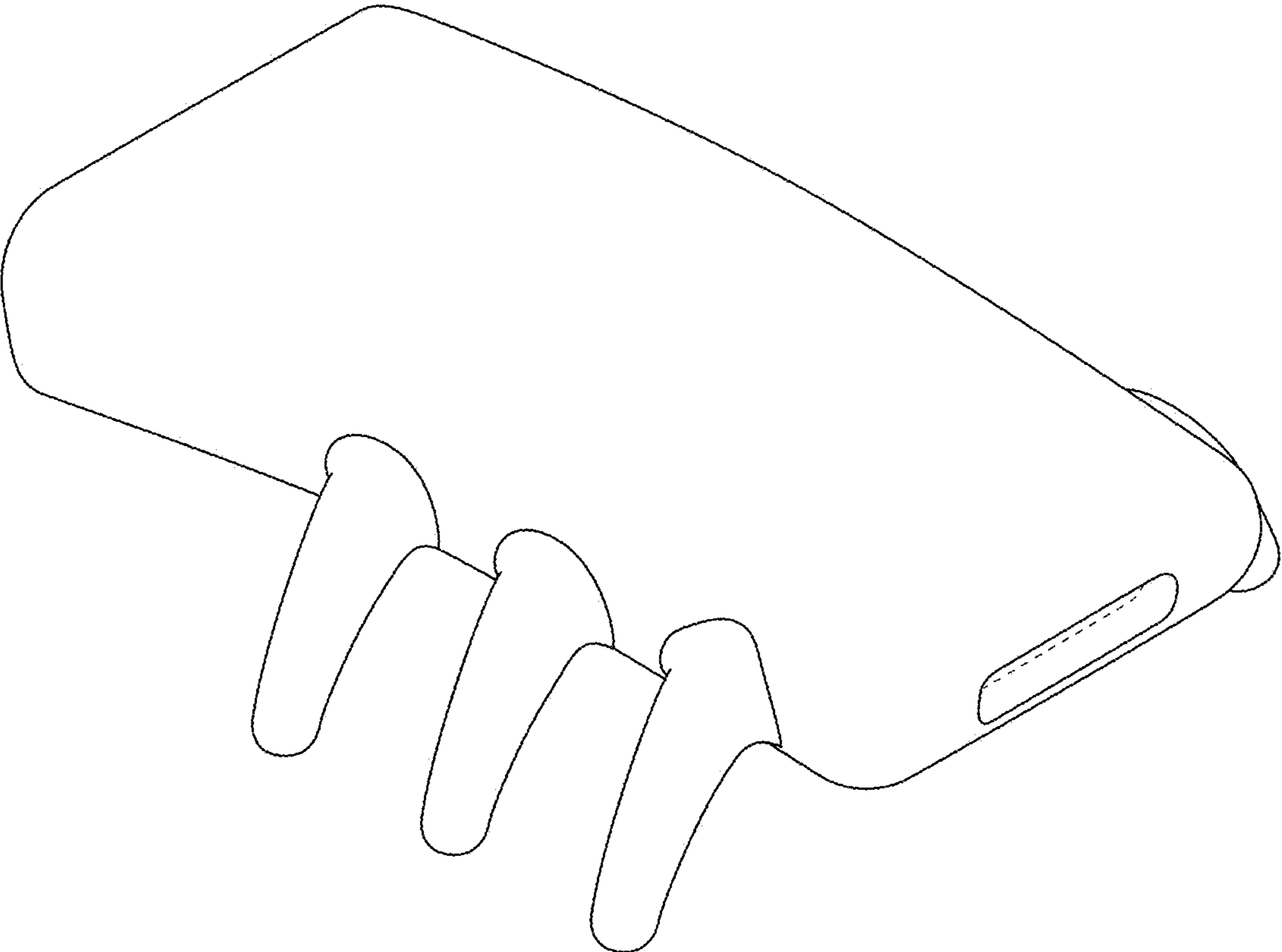

FIG. 4

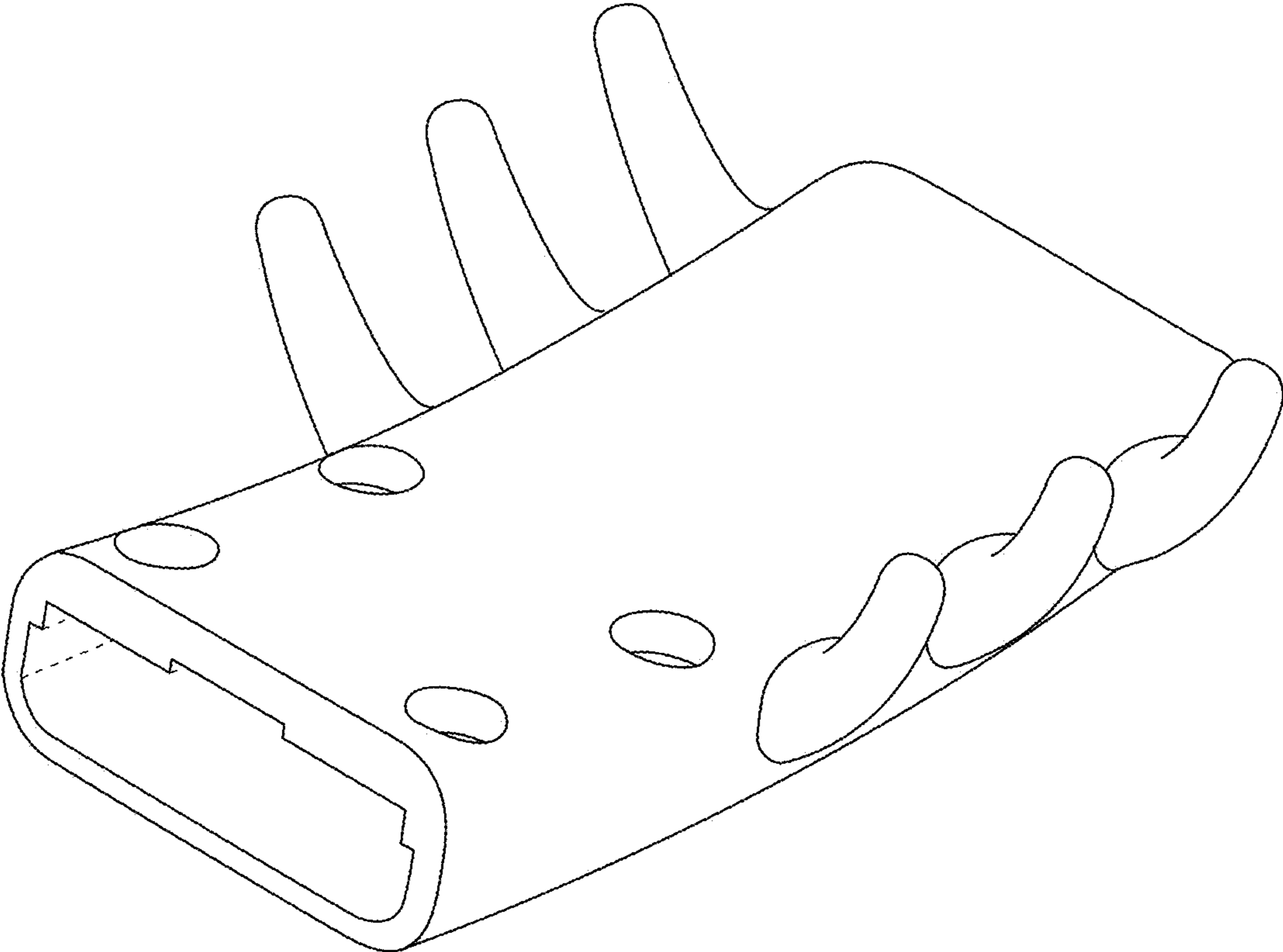

FIG. 5

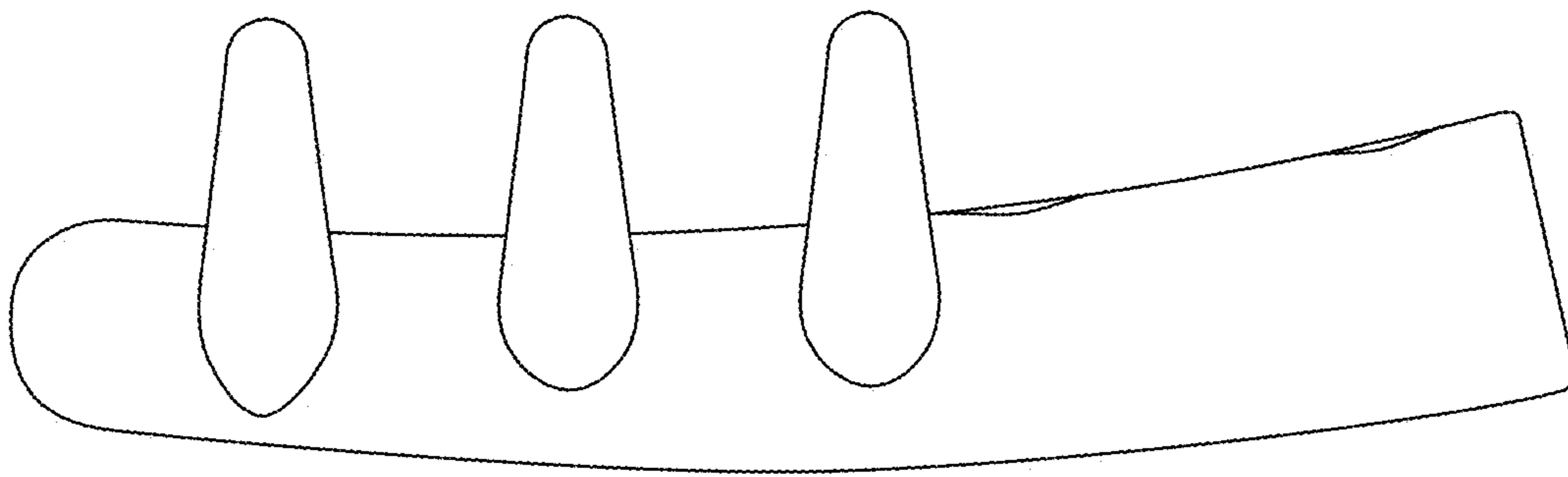

FIG. 6

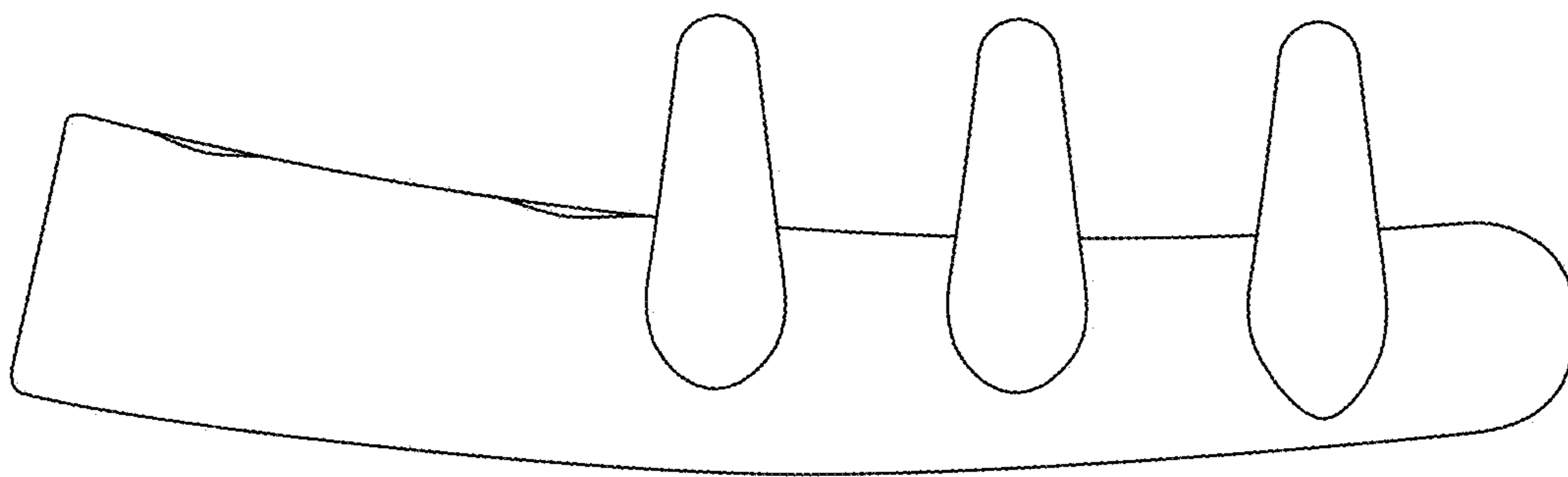

FIG. 7

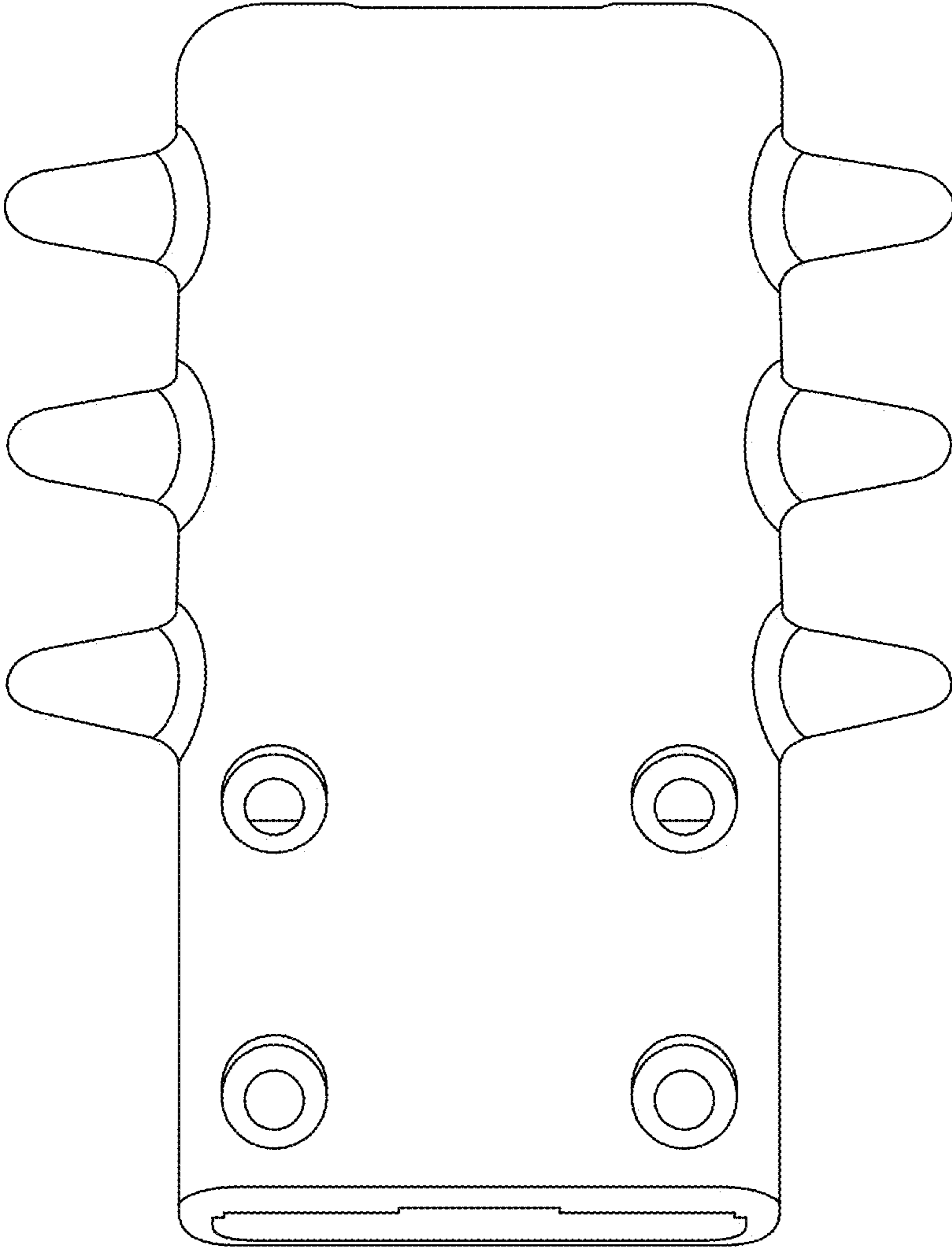

FIG. 8