

US00D935606S

(12) **United States Design Patent** (10) **Patent No.:** **US D935,606 S**
Matsui et al. (45) **Date of Patent:** **** Nov. 9, 2021**

(54) **DISPOSABLE DIAPER**

(71) Applicant: **UNICHARM CORPORATION**, Ehime (JP)

(72) Inventors: **Takashi Matsui**, Kanonji (JP); **Yasuhiro Yamanaka**, Kanonji (JP); **Satoru Sakaguchi**, Kanonji (JP)

(73) Assignee: **UNICHARM CORPORATION**, Ehime (JP)

(**) Term: **15 Years**

(21) Appl. No.: **29/691,140**

(22) Filed: **May 14, 2019**

(30) **Foreign Application Priority Data**

Nov. 15, 2018 (KR) 30-2018-0052840

(51) **LOC (13) Cl.** **24-04**

(52) **U.S. Cl.**
USPC **D24/126**

(58) **Field of Classification Search**
USPC D24/124-126, 187, 189, 190, 132, 136, D24/128; D2/700, 701, 711, 712, 713,
(Continued)

(56) **References Cited**

U.S. PATENT DOCUMENTS

D284,036 S * 6/1986 Birring D24/126
D414,262 S * 9/1999 Ashton D24/124
(Continued)

FOREIGN PATENT DOCUMENTS

CN 303879582 S 10/2016
JP 2016187510 A 11/2016

OTHER PUBLICATIONS

English Machine Translation for Japanese Publication No. 2016-187510 A, published Nov. 4, 2016, 16 pgs.

(Continued)

Primary Examiner — T Chase Nelson

Assistant Examiner — Kelly L Gross

(74) *Attorney, Agent, or Firm* — Fredrikson & Byron, P.A.

(57) **CLAIM**

We claim the ornamental design for a disposable diaper, as shown and described.

DESCRIPTION

FIG. 1 is a front perspective view of the first embodiment of a disposable diaper showing our new design.

FIG. 2 is a rear perspective view thereof;

FIG. 3 is a front view thereof;

FIG. 4 is a rear view thereof;

FIG. 5 is a left side elevational view thereof;

FIG. 6 is a right side elevational view thereof;

FIG. 7 is a top plan view thereof;

FIG. 8 is a bottom plan view thereof;

FIG. 9 is an enlarged fragmentary view defined by line 9 in FIG. 1;

FIG. 10 is an enlarged fragmentary view defined by line 10 in FIG. 3;

FIG. 11 is an enlarged fragmentary view defined by line 11 in FIG. 7;

FIG. 12 is an enlarged fragmentary view defined by line 12 in FIG. 10 showing the inside of the waist band in an open condition;

FIG. 13 is an enlarged cross-sectional view taken along line 13-13 in FIG. 10;

FIG. 14 is a front perspective view of the second embodiment of a disposable diaper showing our new design.

FIG. 15 is a rear perspective view thereof;

FIG. 16 is a front view thereof;

FIG. 17 is a rear view thereof;

FIG. 18 is a left side elevational view thereof;

FIG. 19 is a right side elevational view thereof;

FIG. 20 is a top plan view thereof;

FIG. 21 is a bottom plan view thereof;

FIG. 22 is an enlarged fragmentary view defined by line 22 in FIG. 14;

FIG. 23 is an enlarged fragmentary view defined by line 23 in FIG. 16;

(Continued)

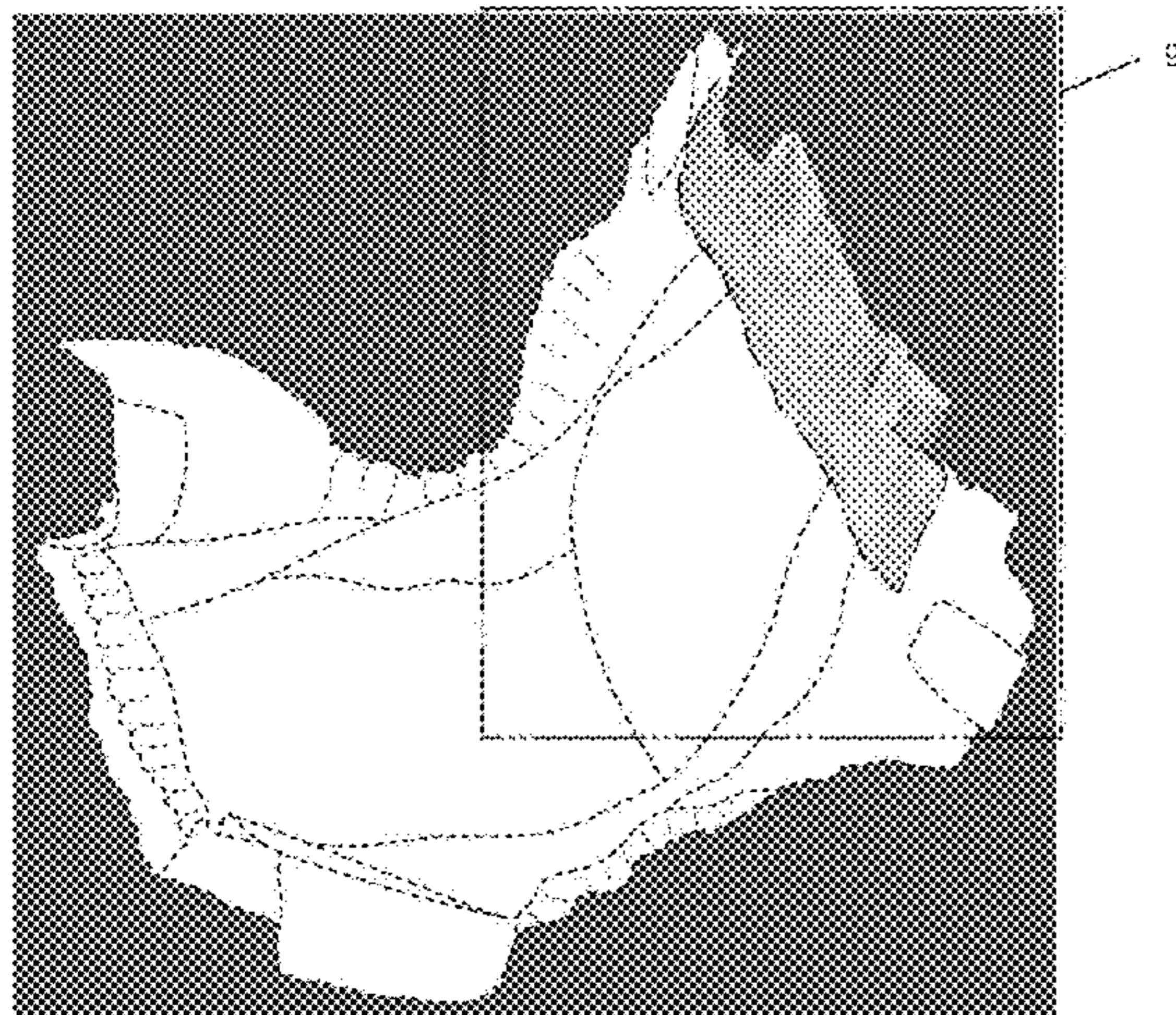

FIG. 24 is an enlarged fragmentary view defined by line 24 in FIG. 20;

FIG. 25 is an enlarged fragmentary view defined by line 25 in FIG. 23 showing the waist band being turn over thereof; and,

FIG. 26 is an enlarged cross-sectional view taken along line 26-26 in FIG. 23.

The broken lines shown in the drawings are for illustrative purposes only, showing portions of the disposable diaper that form no part of the claimed design.

1 Claim, 26 Drawing Sheets

(58) Field of Classification Search

USPC D2/714, 706, 766, 767, 785, 811, 819;
 D5/21, 25, 29, 35, 37, 39, 53, 59, 60, 61,
 D5/32, 40, 57; D29/101.5, 119, 121.1,
 D29/124; D6/354
 CPC A61F 13/15; A61F 13/64; A61F 13/476;
 A61F 13/5611; A61F 13/5633; A61F
 13/4704; A61F 13/535; A61F 13/539;
 A61F 13/47; A61F 13/531; A61F
 2013/16; A61F 2013/4708; A61F 13/62;
 A61F 13/505; A61F 13/55115; A61F
 13/551; A61L 15/00; A61L 26/00; B32B
 7/12; B32B 5/022

See application file for complete search history.

(56) References Cited

U.S. PATENT DOCUMENTS

D452,946 S * 1/2002 Kim D2/700
 D453,259 S * 2/2002 Kim D2/700
 D454,423 S * 3/2002 Kim D2/700
 D477,404 S * 7/2003 Carr D24/126
 D477,872 S * 7/2003 Sosalla D24/126
 D478,169 S * 8/2003 Sosalla D24/126
 D498,298 S * 11/2004 Otsubo D24/124
 D522,653 S * 6/2006 Otsubo D24/126
 7,112,193 B2 * 9/2006 Otsubo A61F 13/51464
 604/385.22
 D581,628 S * 12/2008 Spring D2/712
 D583,050 S * 12/2008 Alston D24/126
 D621,032 S * 8/2010 Nakaoka D24/126
 D621,034 S * 8/2010 Nakaoka A61F 13/4915
 D24/126

7,765,614 B2 * 8/2010 Takino A61F 13/496
 2/111
 D632,055 S * 2/2011 Wynn D2/712
 D638,198 S * 5/2011 Toratani D2/712
 D639,936 S * 6/2011 Faulks D24/126
 D641,955 S * 7/2011 Toratani D2/712
 D679,390 S * 4/2013 Hedbratt D24/126
 8,475,424 B2 * 7/2013 Fujimoto A61F 13/496
 604/385.13
 9,238,348 B2 * 1/2016 Zhou A61L 15/44
 D760,892 S * 7/2016 Hedbratt D24/126
 D774,644 S * 12/2016 Elston D24/124
 D782,663 S * 3/2017 Morimoto D24/126
 9,675,499 B2 * 6/2017 Evenson A61F 13/496
 D800,300 S * 10/2017 Yamada D24/126
 D804,656 S * 12/2017 Agami D24/126
 D804,657 S * 12/2017 Melendez D24/126
 D804,667 S * 12/2017 Melendez D24/146
 D805,191 S * 12/2017 Yamada D24/126
 D805,635 S * 12/2017 Yamada D24/126
 D806,239 S * 12/2017 Melendez D24/126
 D806,867 S * 1/2018 Yamada D24/126
 D806,868 S * 1/2018 Melendez D24/126
 D806,869 S * 1/2018 Menner D24/126
 D806,870 S * 1/2018 Menner D24/126
 D809,135 S * 1/2018 Menner D24/126
 D813,496 S * 3/2018 Yeoh D2/712
 D834,785 S * 12/2018 Yamada D2/712
 D839,419 S * 1/2019 Melendez A61L 15/44
 D24/126
 10,172,747 B2 * 1/2019 May A61F 13/4915
 D843,566 S * 3/2019 Melendez D24/126
 D854,280 S * 7/2019 Ngangu D2/712
 D902,396 S * 11/2020 Yamada D24/126
 D902,397 S * 11/2020 Yamada D24/126
 10,869,788 B2 * 12/2020 Manabe A61F 13/15617
 D912,808 S * 3/2021 Tammen A61F 13/15617
 D24/126
 10,973,709 B2 * 4/2021 Seitz A61F 13/55115
 10,987,255 B2 * 4/2021 Ohtsubo B32B 5/022
 2010/0318053 A1 * 12/2010 Smet A61F 13/49017
 604/385.23
 2018/0071155 A1 3/2018 Bishop et al.
 2021/0059869 A1 * 3/2021 Arita A61F 13/49

OTHER PUBLICATIONS

CN 303879582 S, published Oct. 12, 2016, taken from the Global Design Database in the WIPO Global Database, with partial English information, 4 pgs.

* cited by examiner

FIG. 1

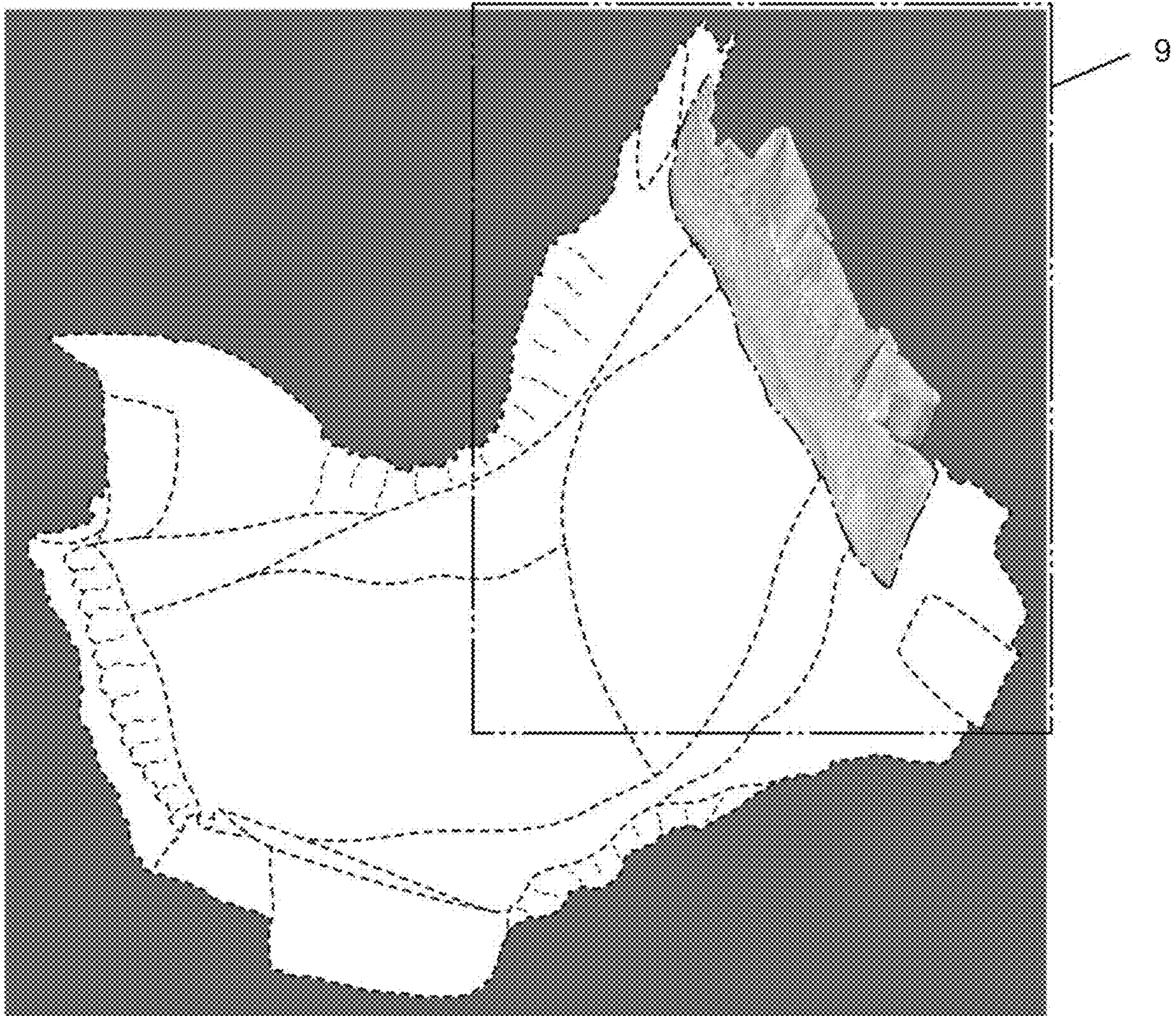

FIG. 2

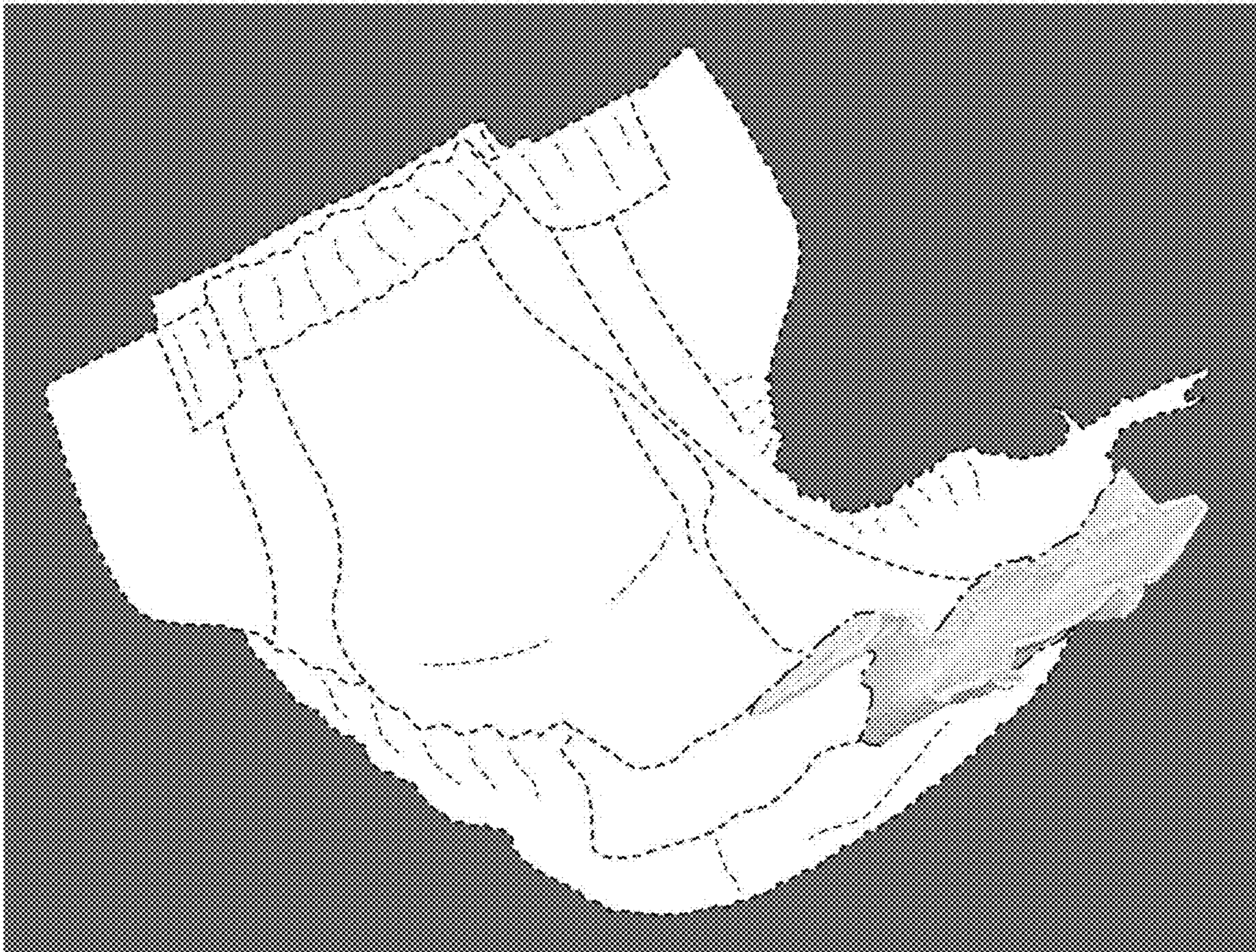

FIG. 3

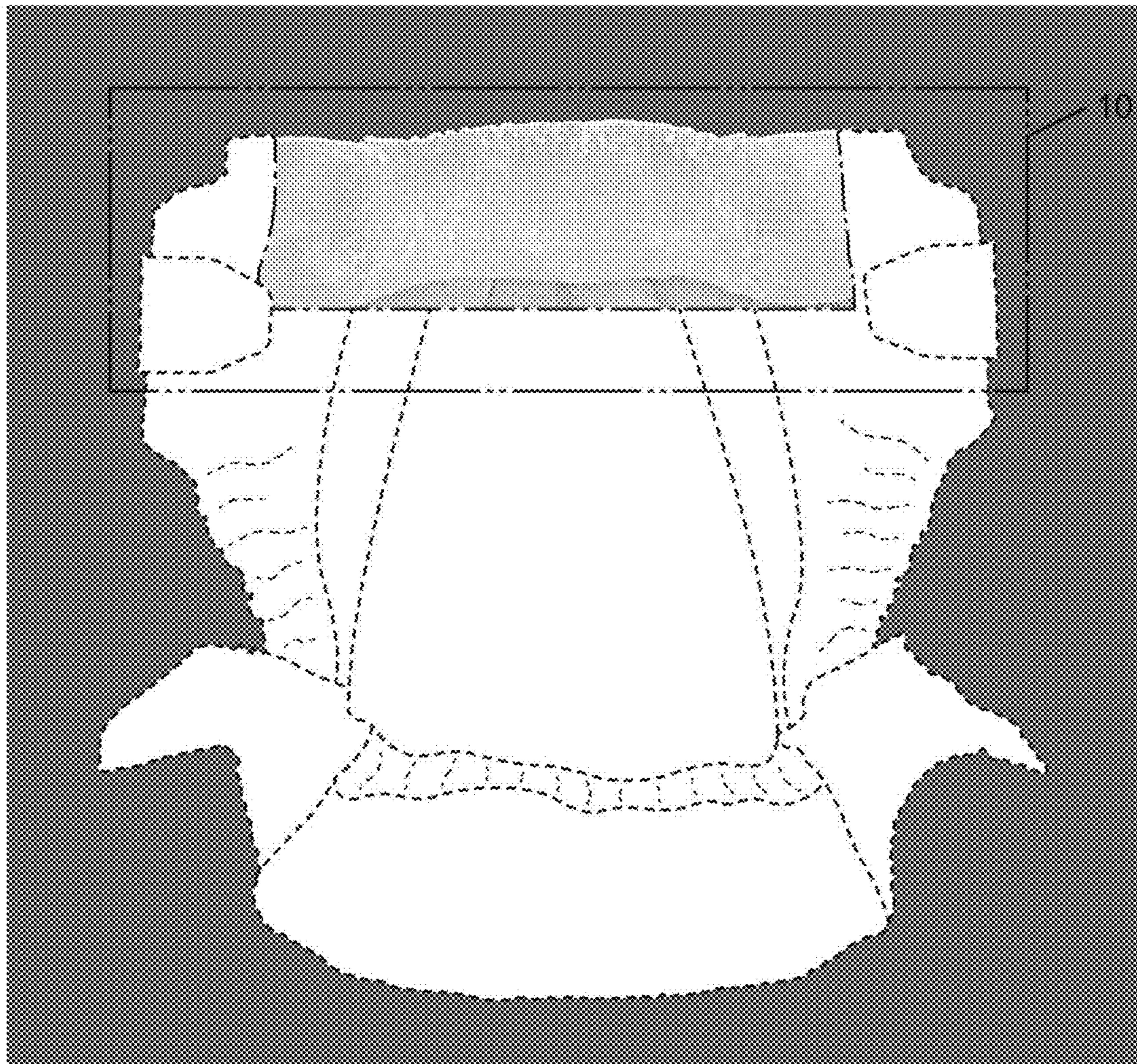

FIG. 4

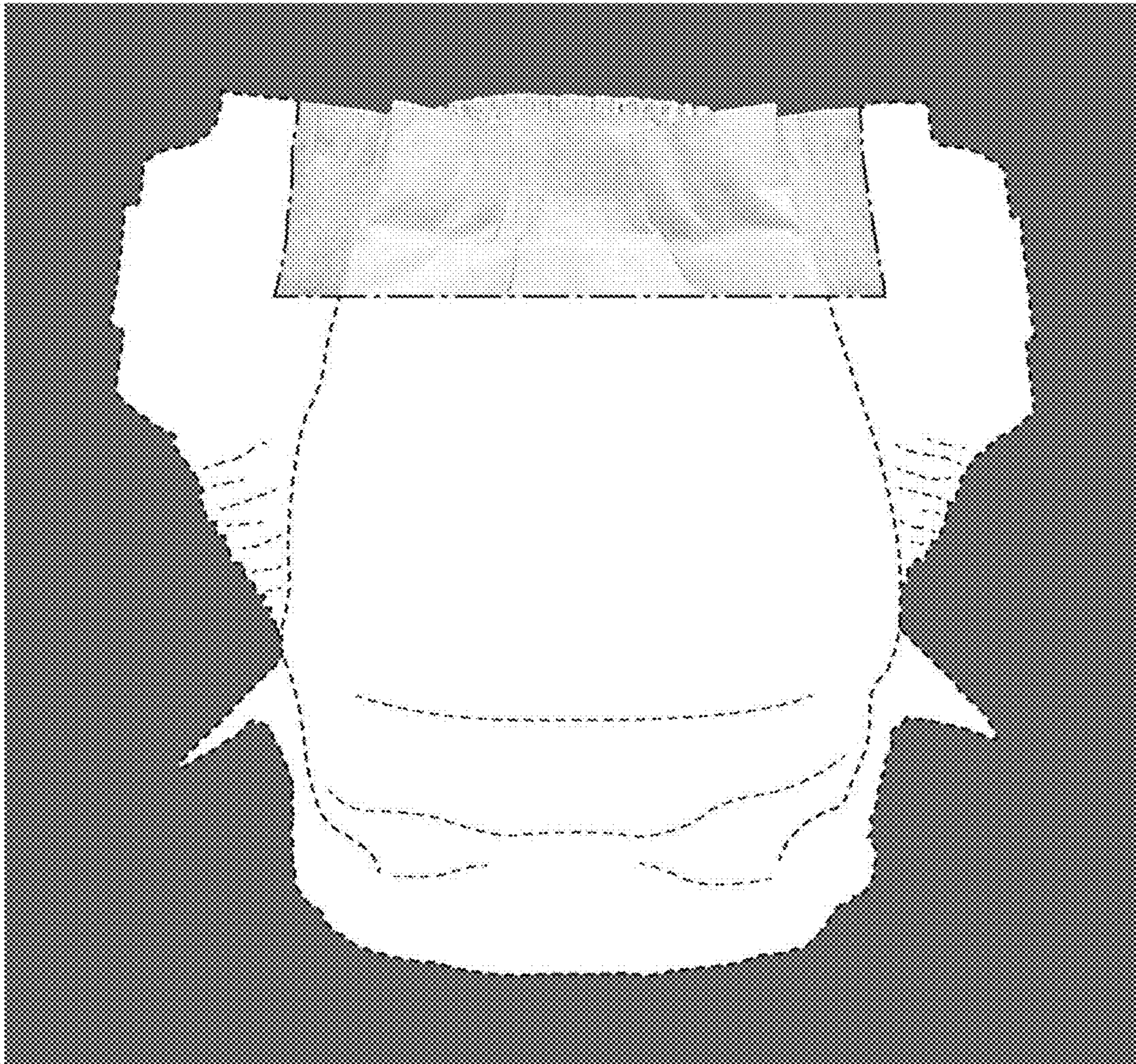

FIG. 5

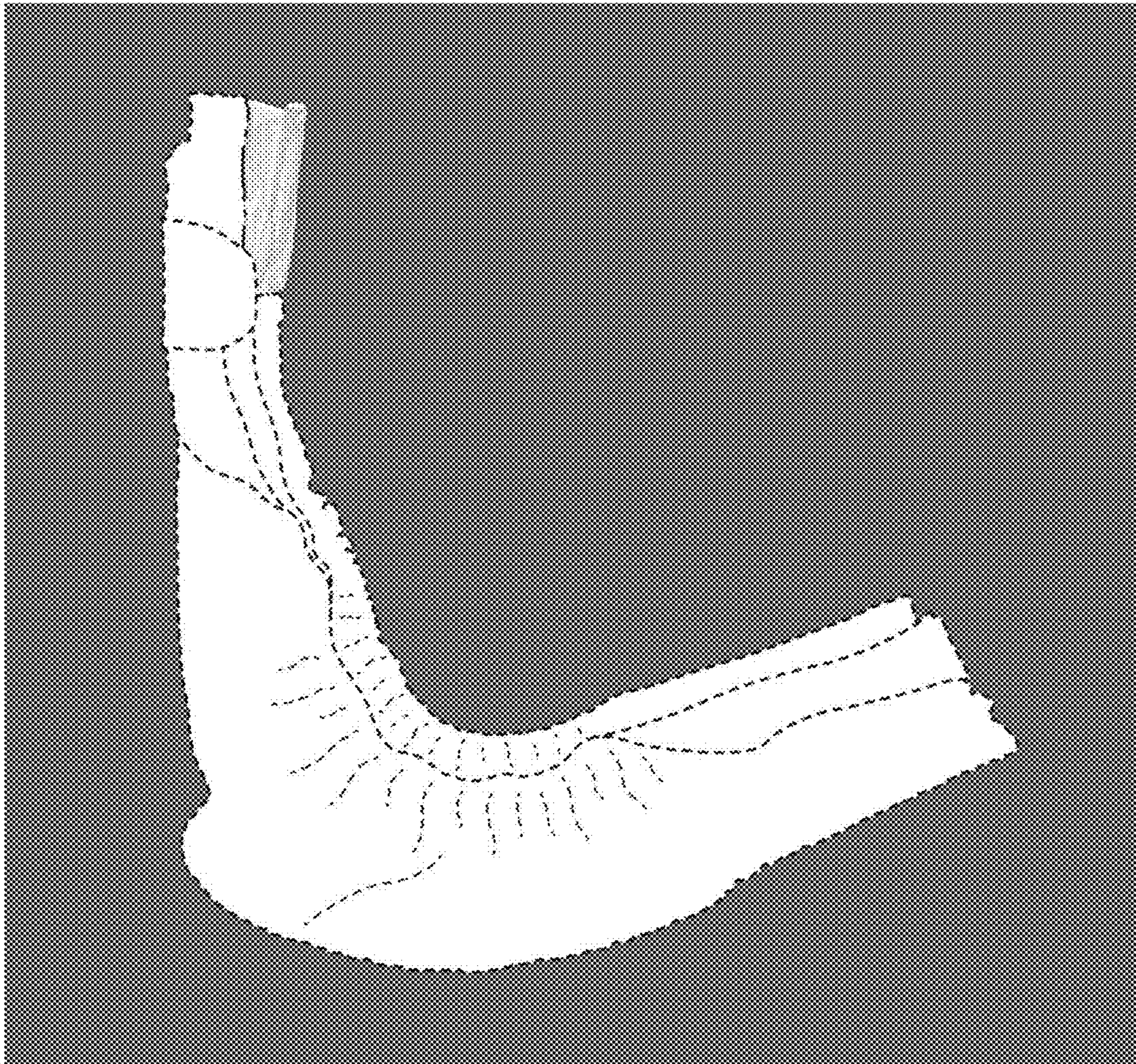

FIG. 6

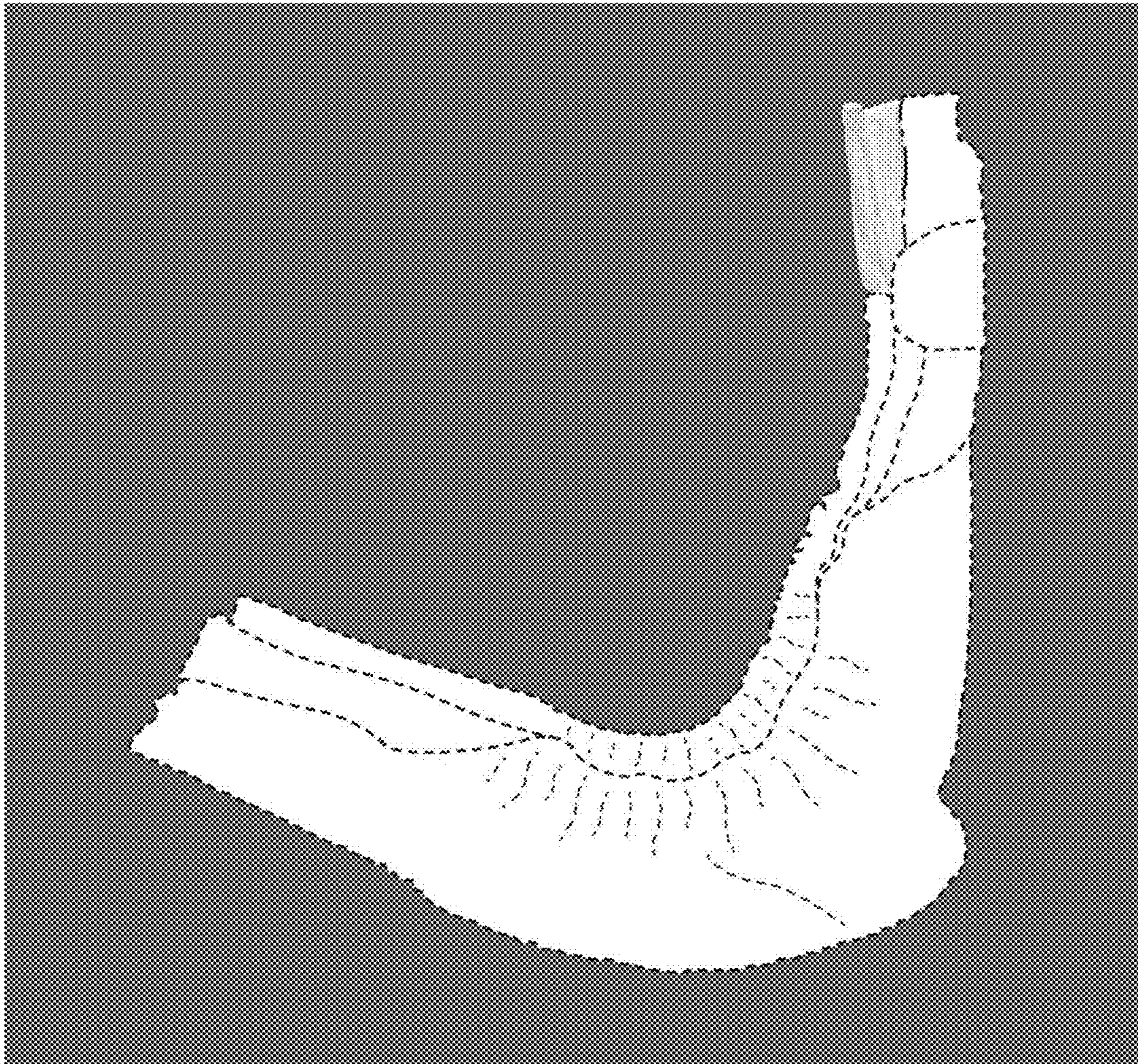

FIG. 7

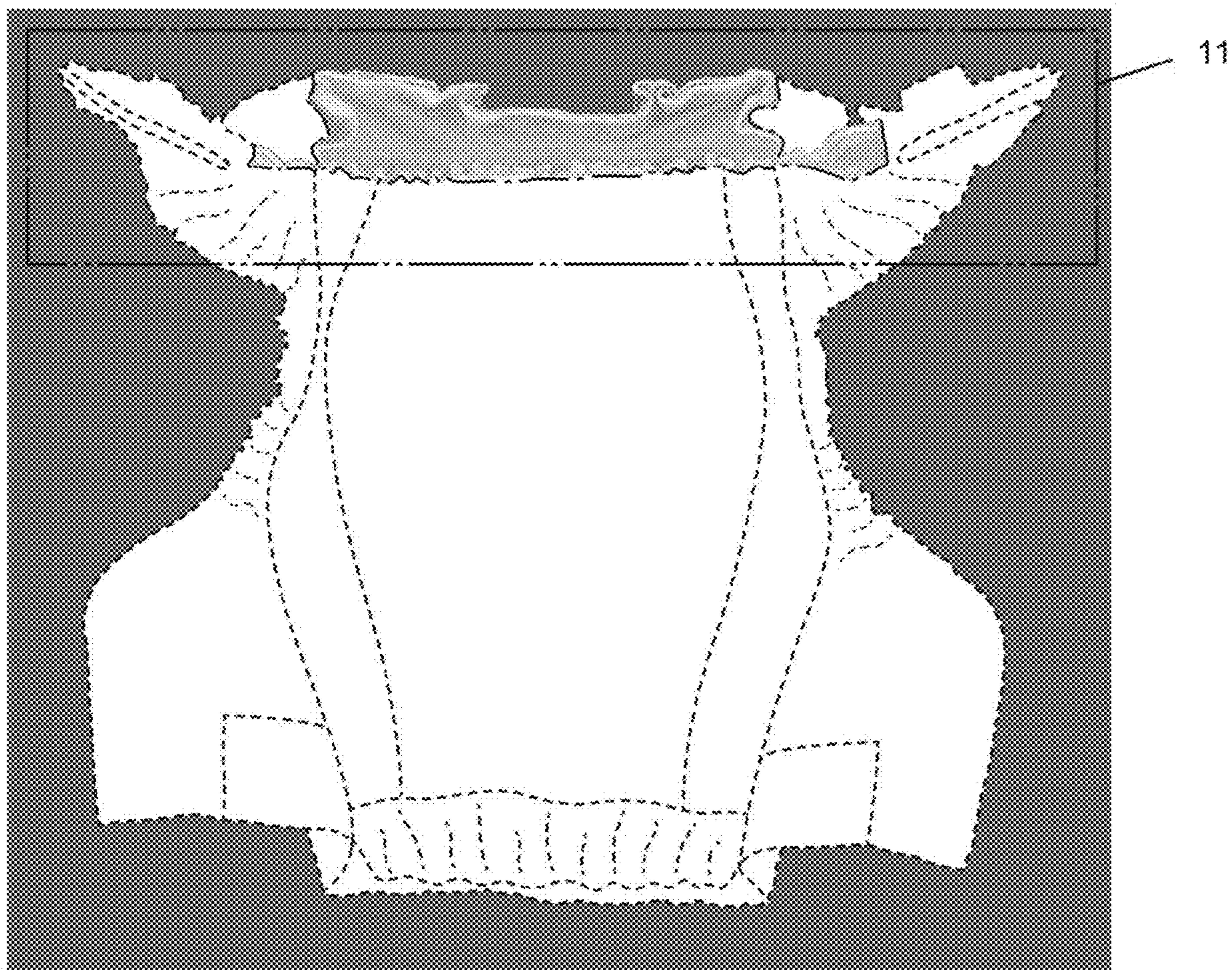

FIG. 8

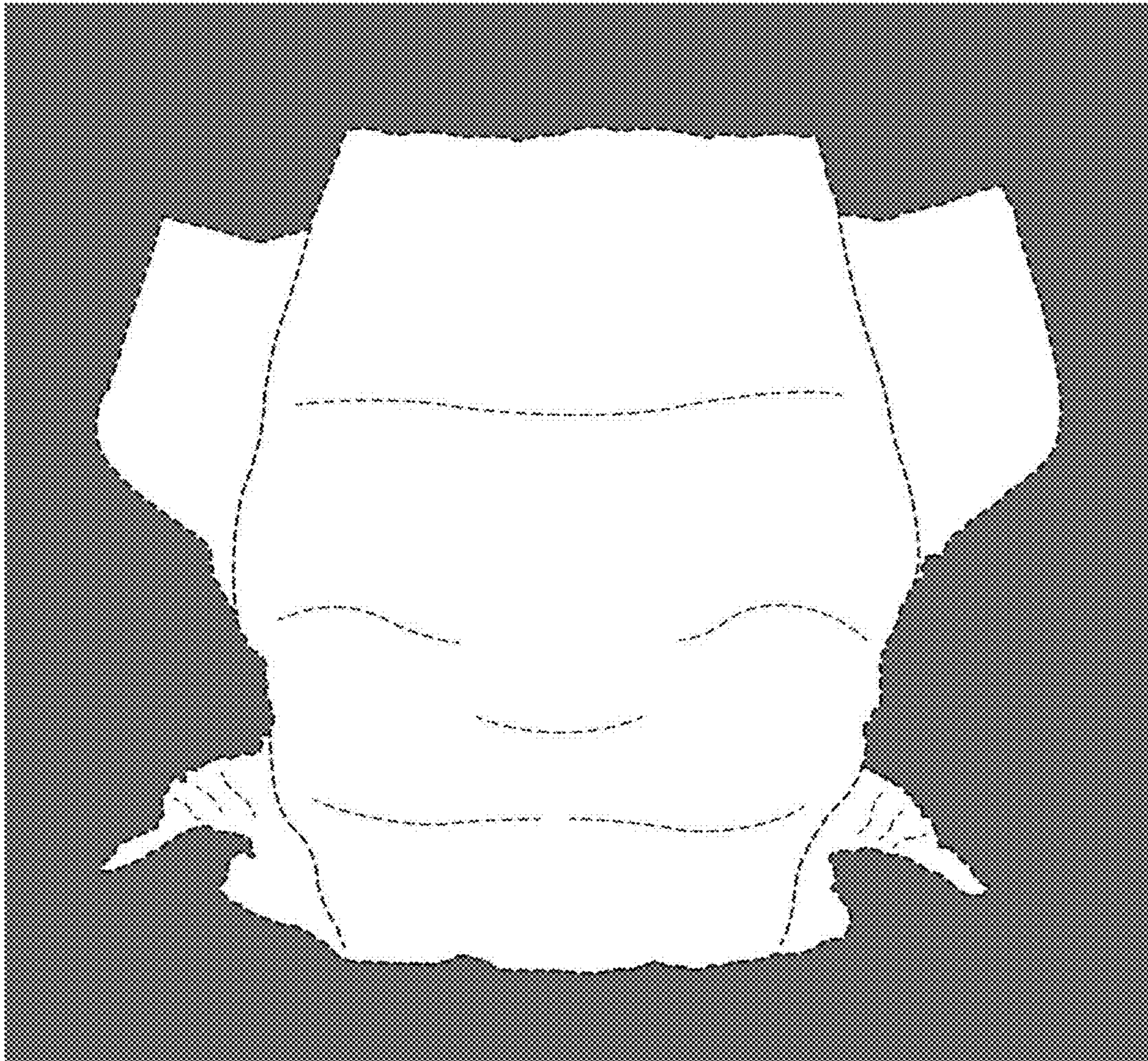

FIG. 9

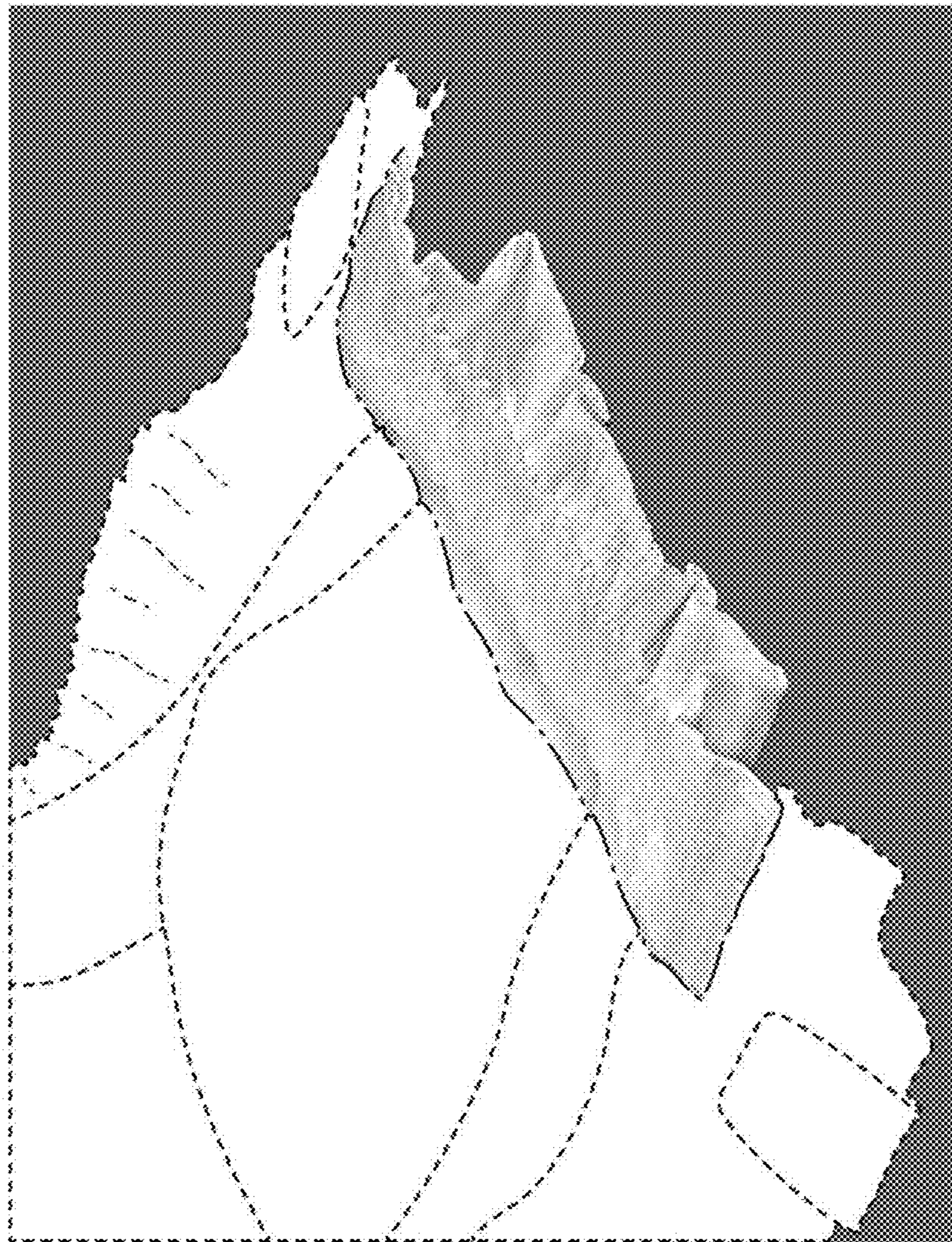

FIG. 10

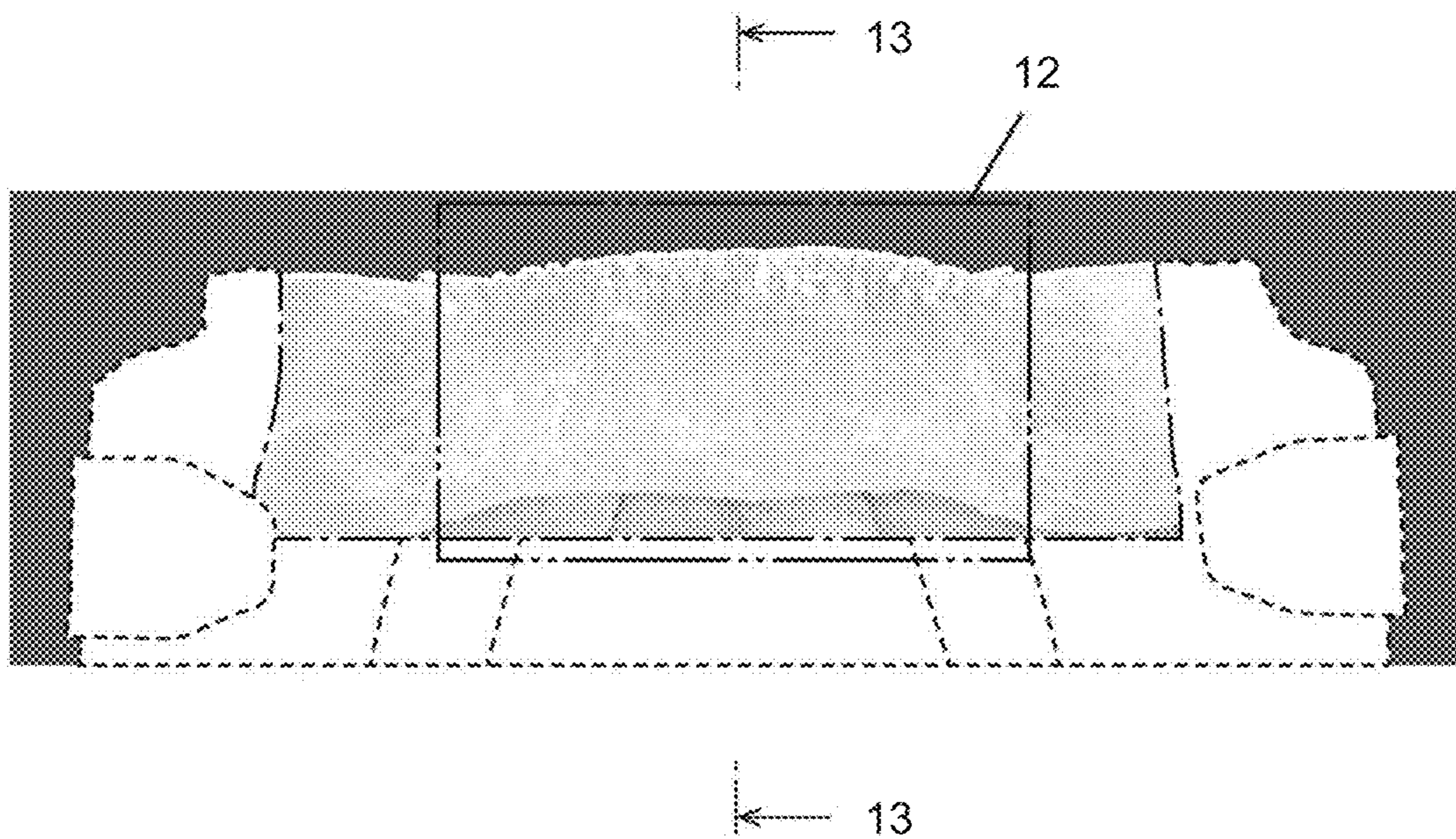

FIG. 11

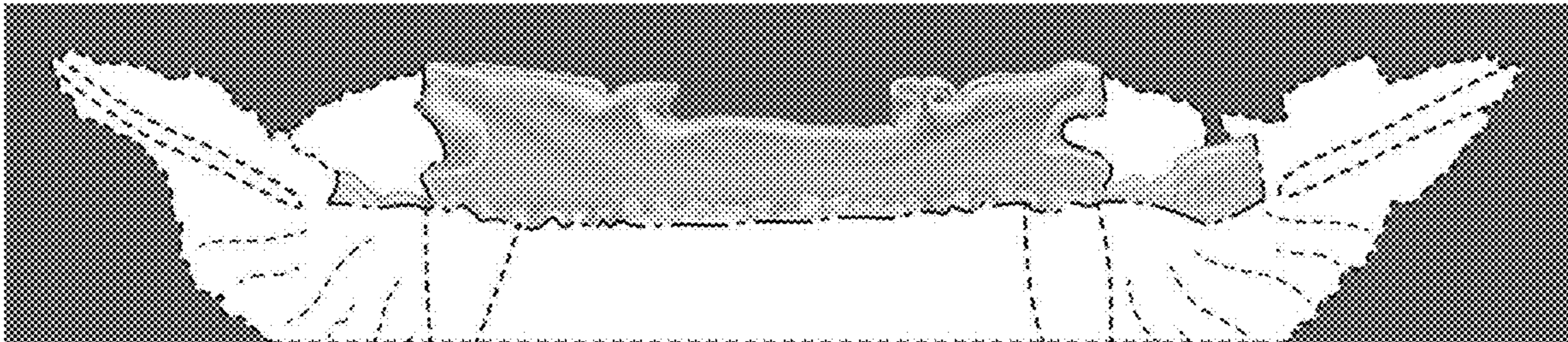

FIG. 12

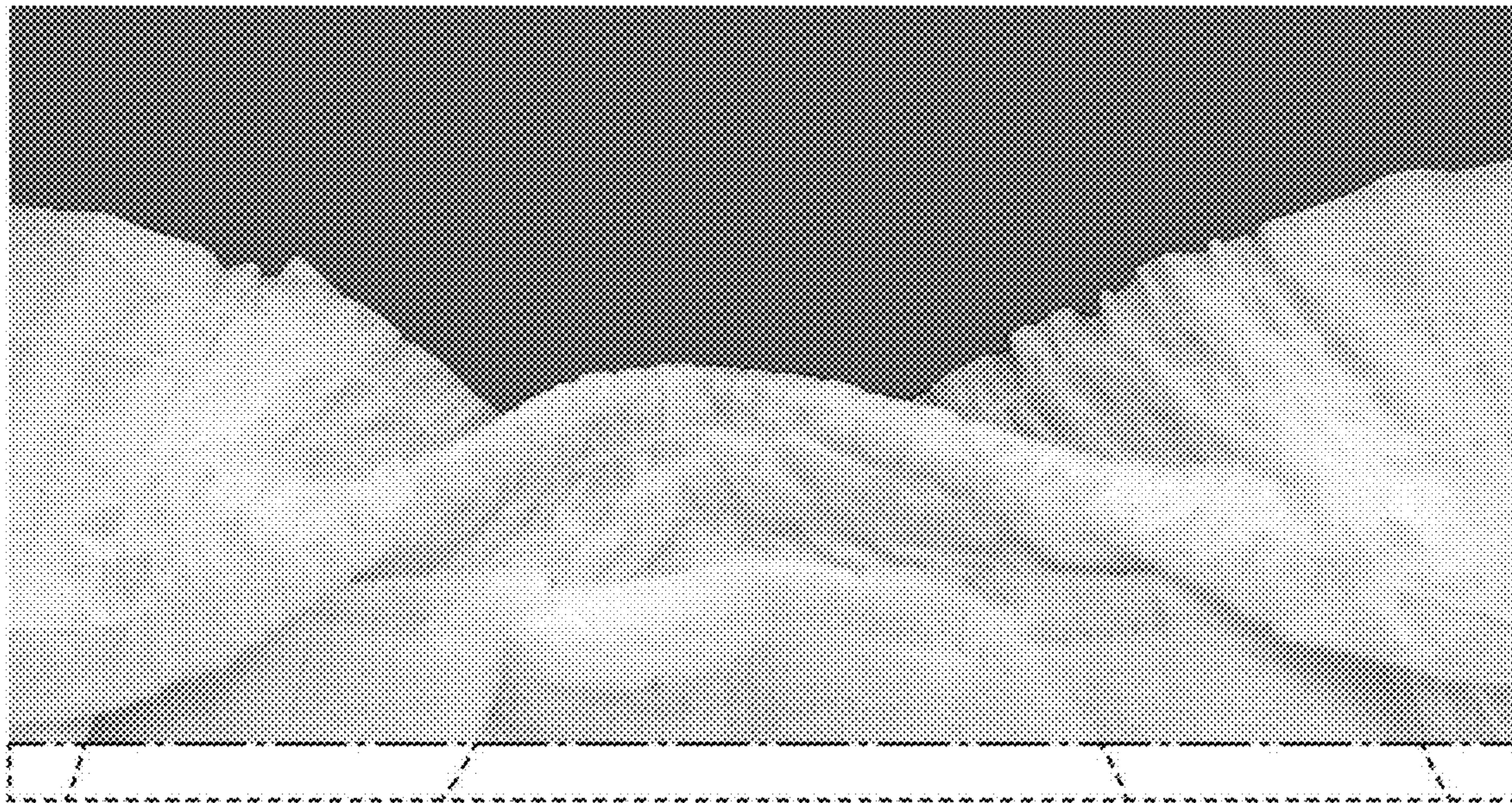

FIG. 13

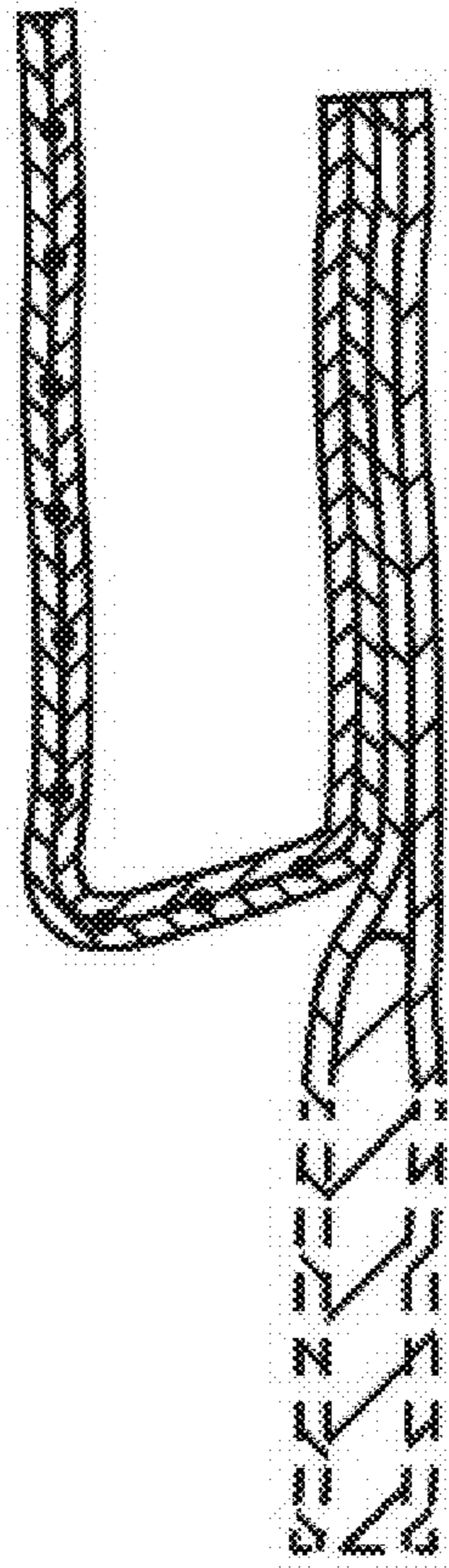

FIG. 14

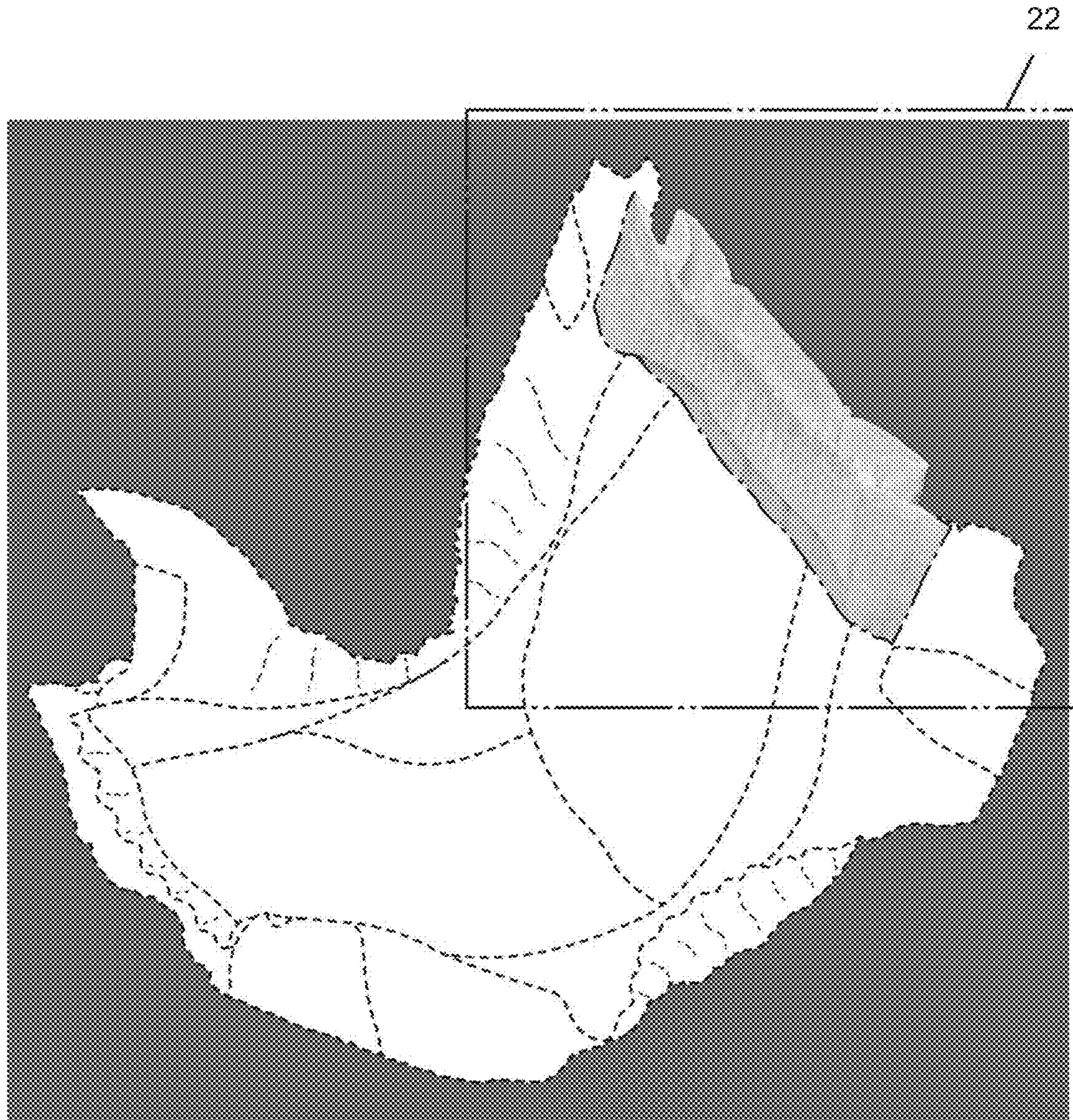

FIG. 15

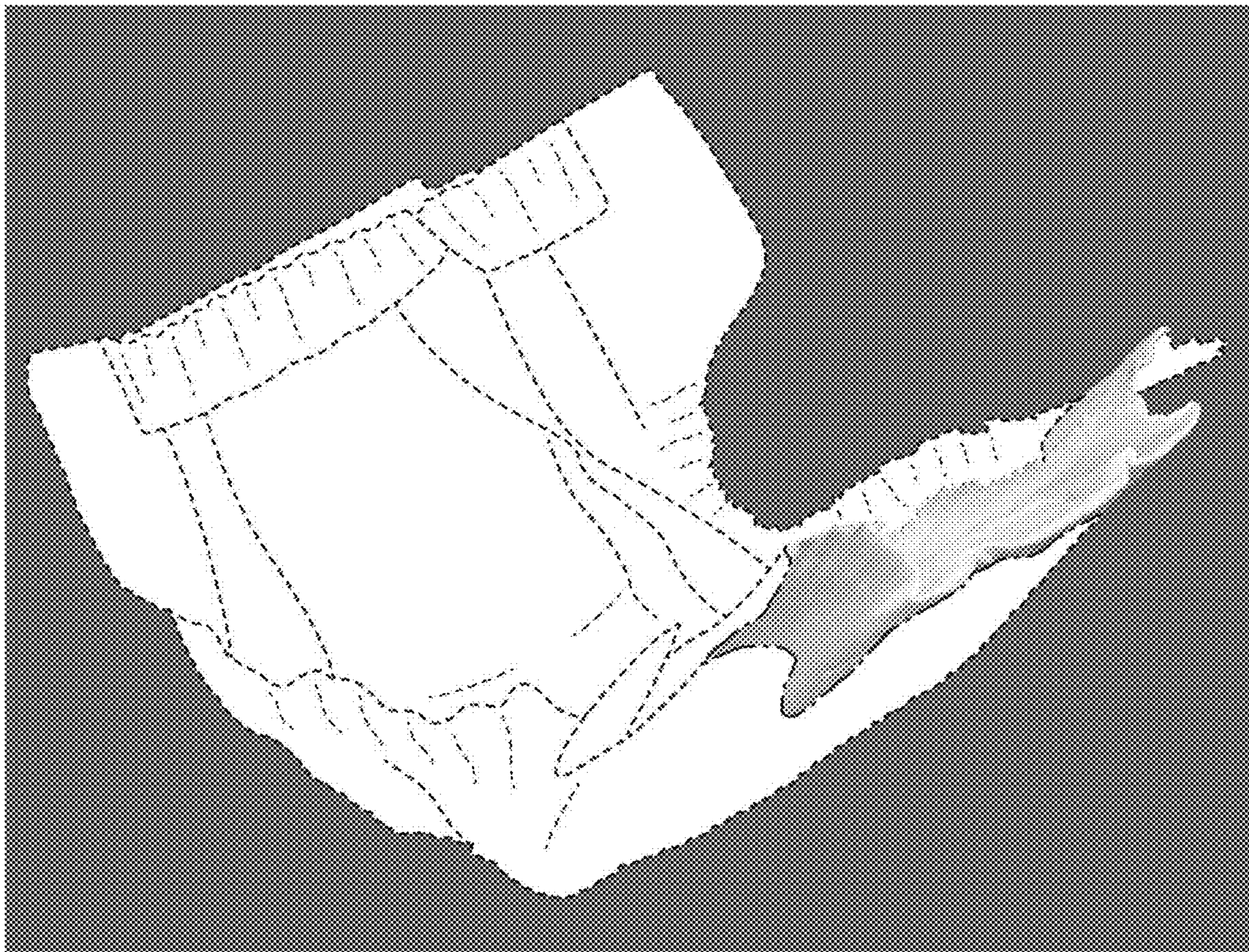

FIG. 16

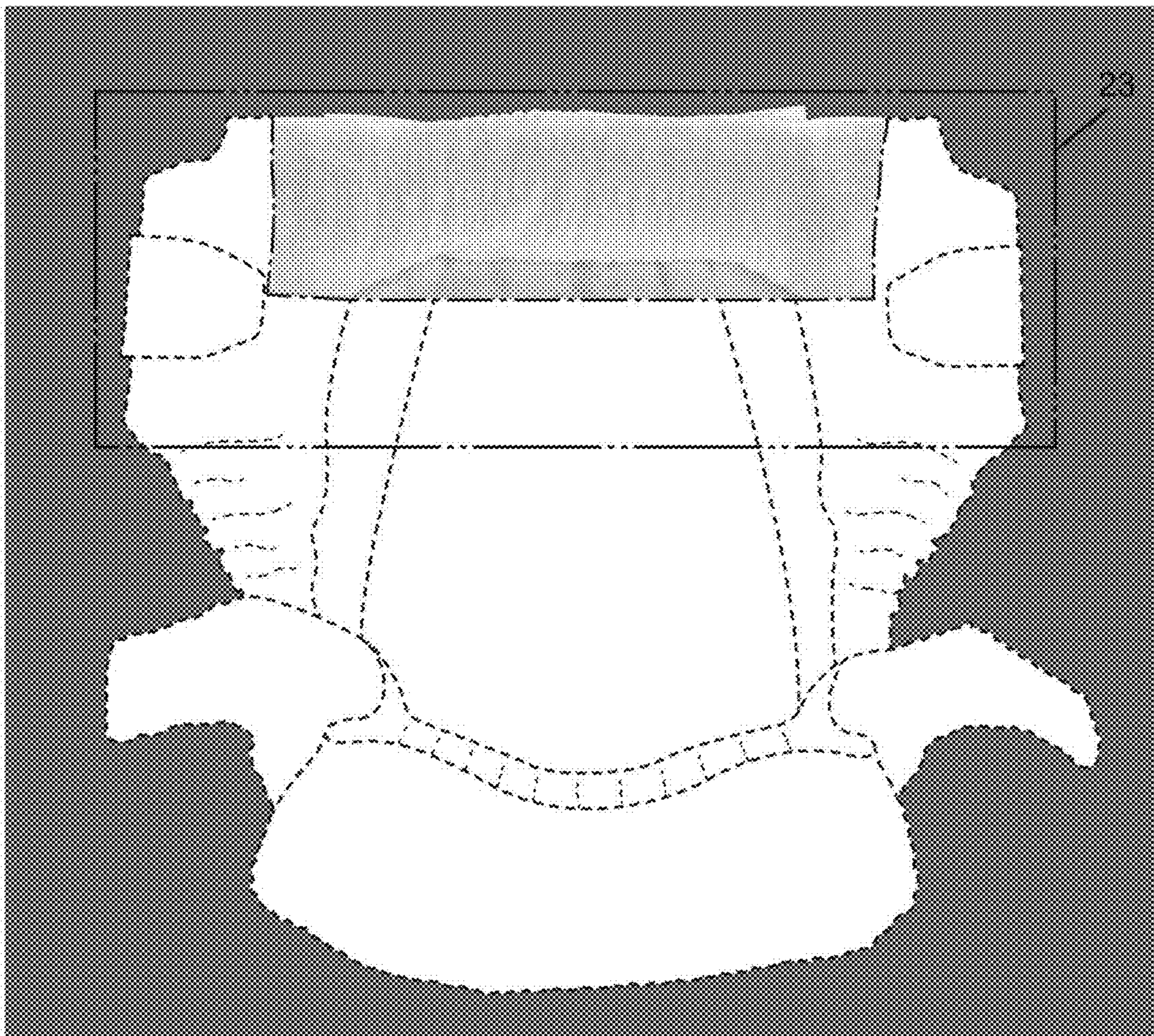

FIG. 17

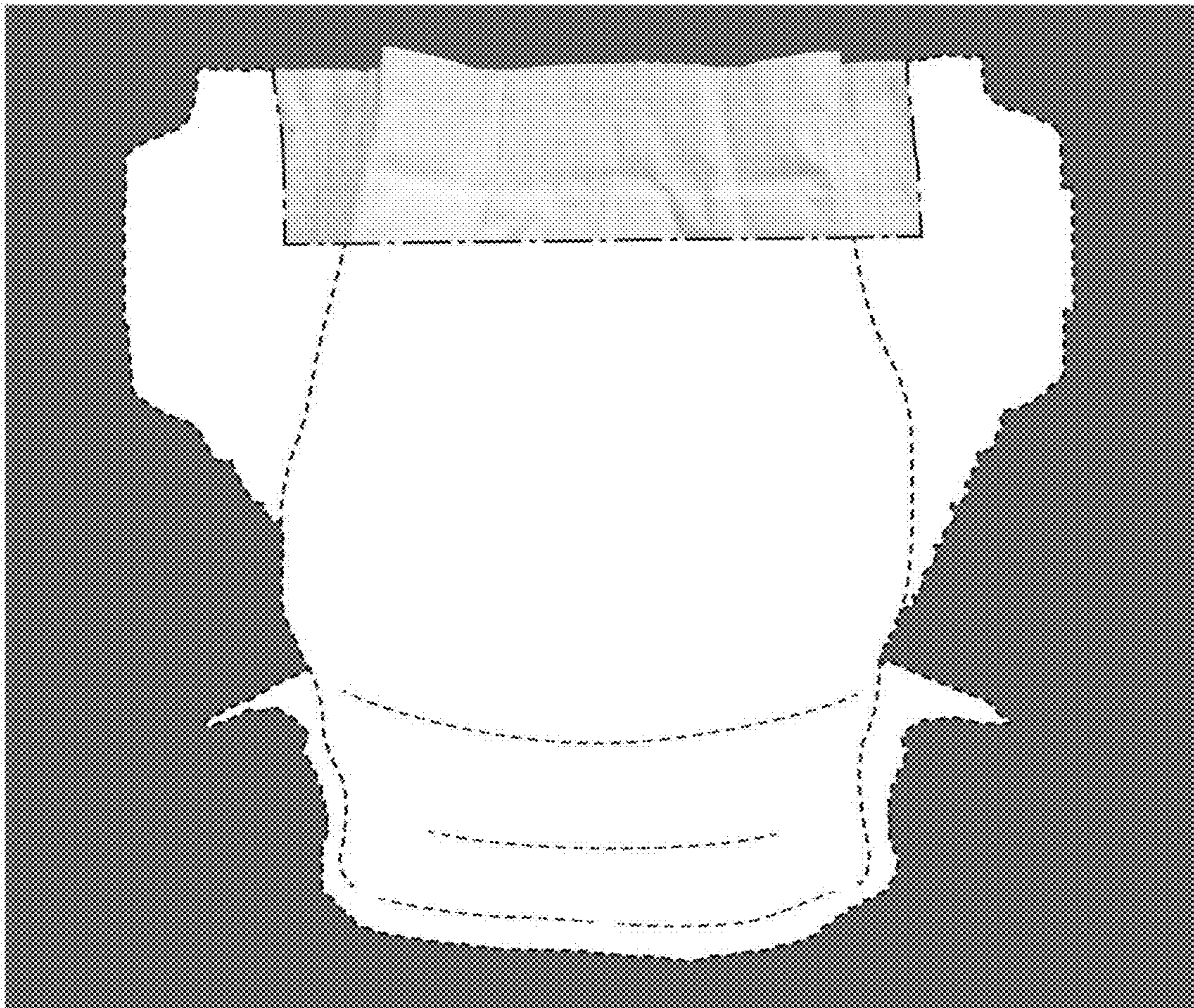

FIG. 18

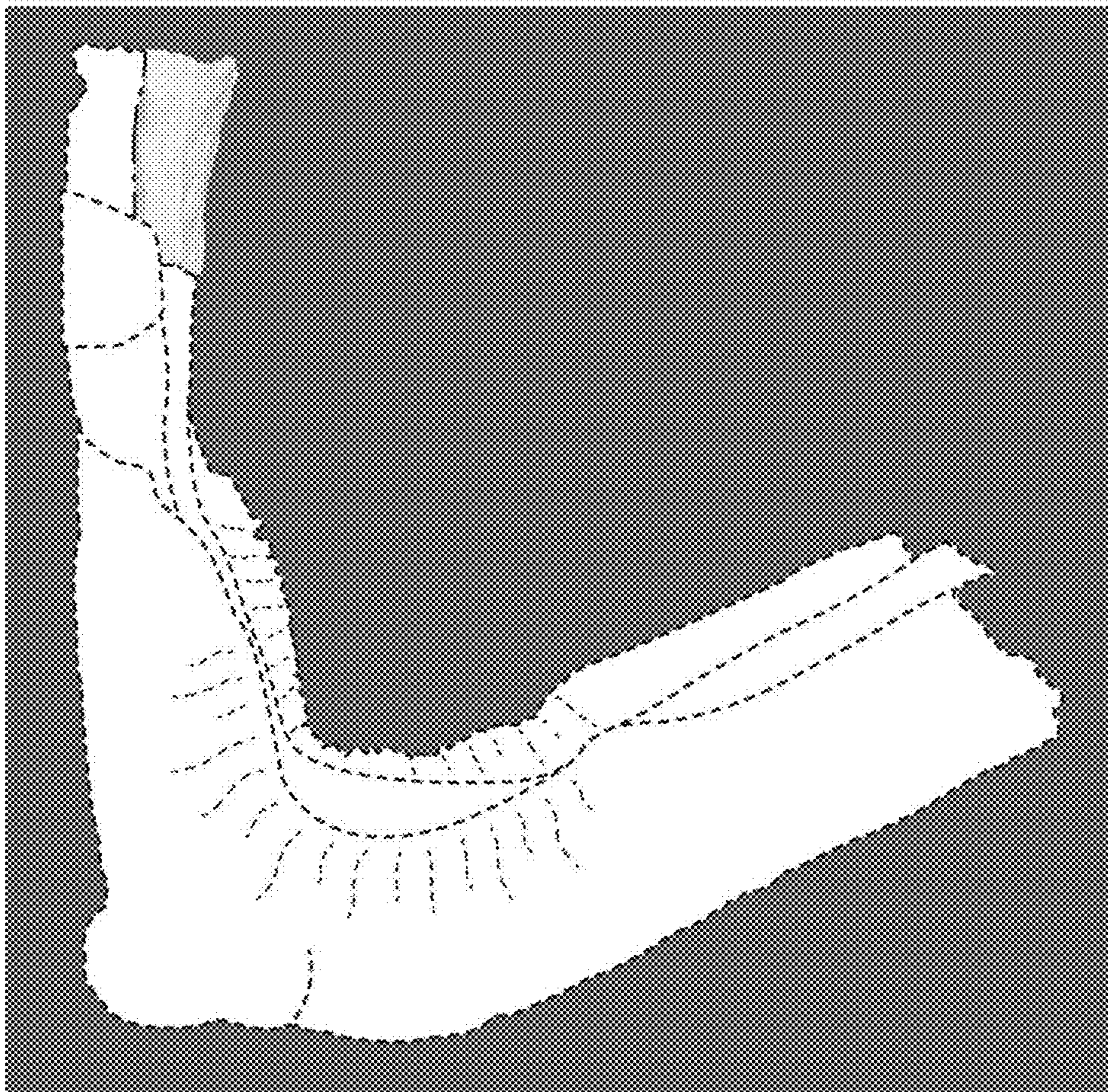

FIG. 19

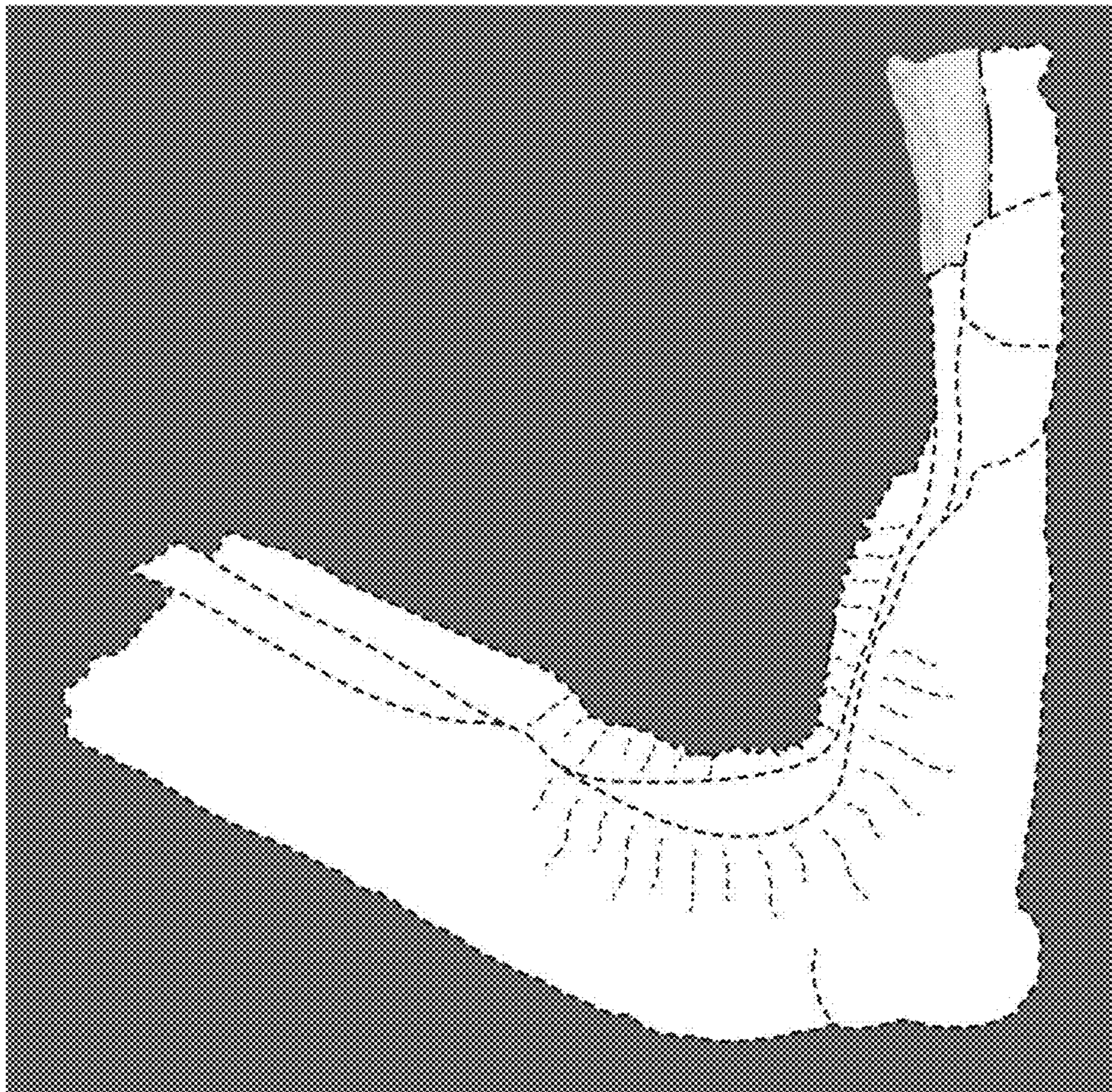

FIG. 20

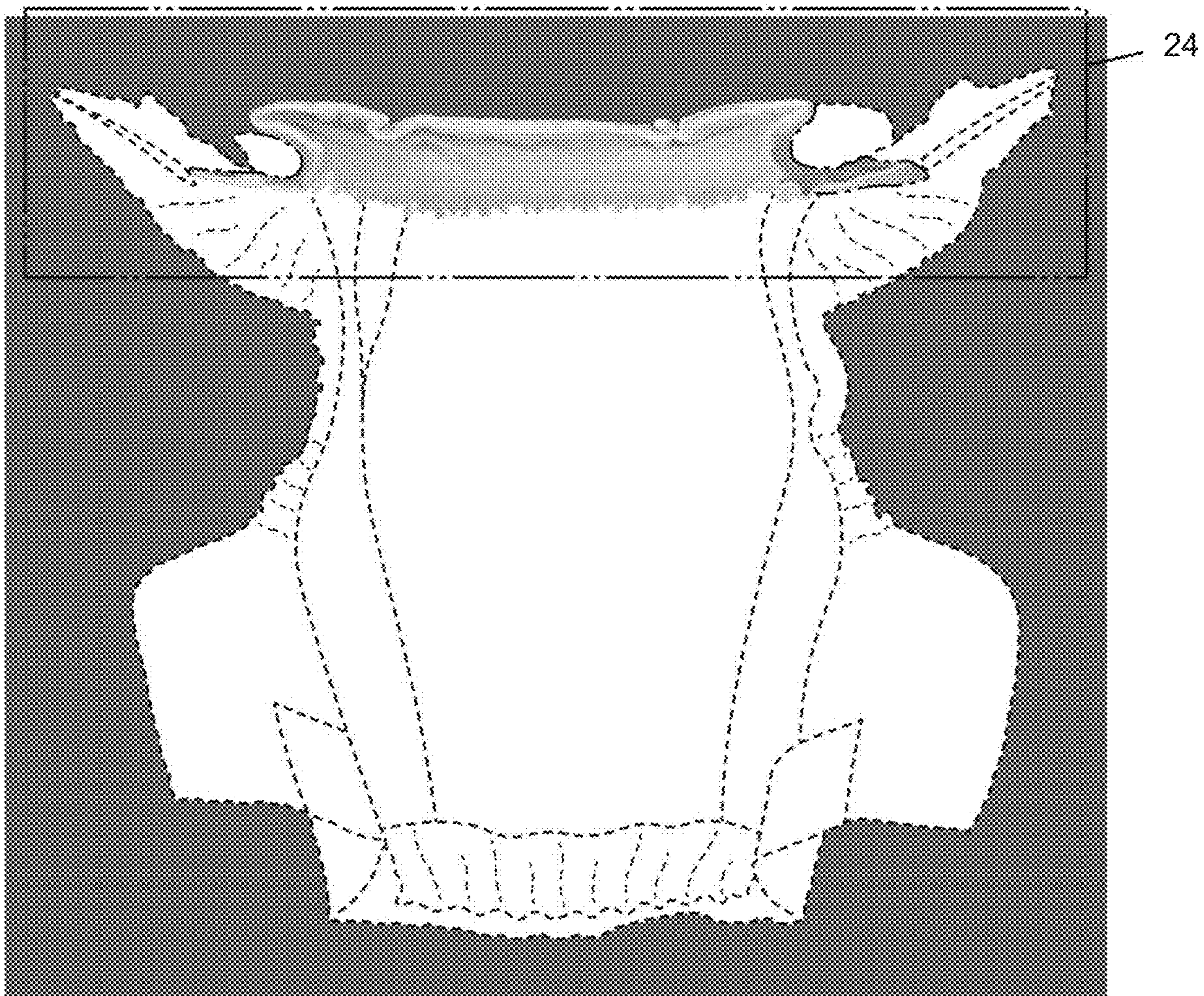

FIG. 21

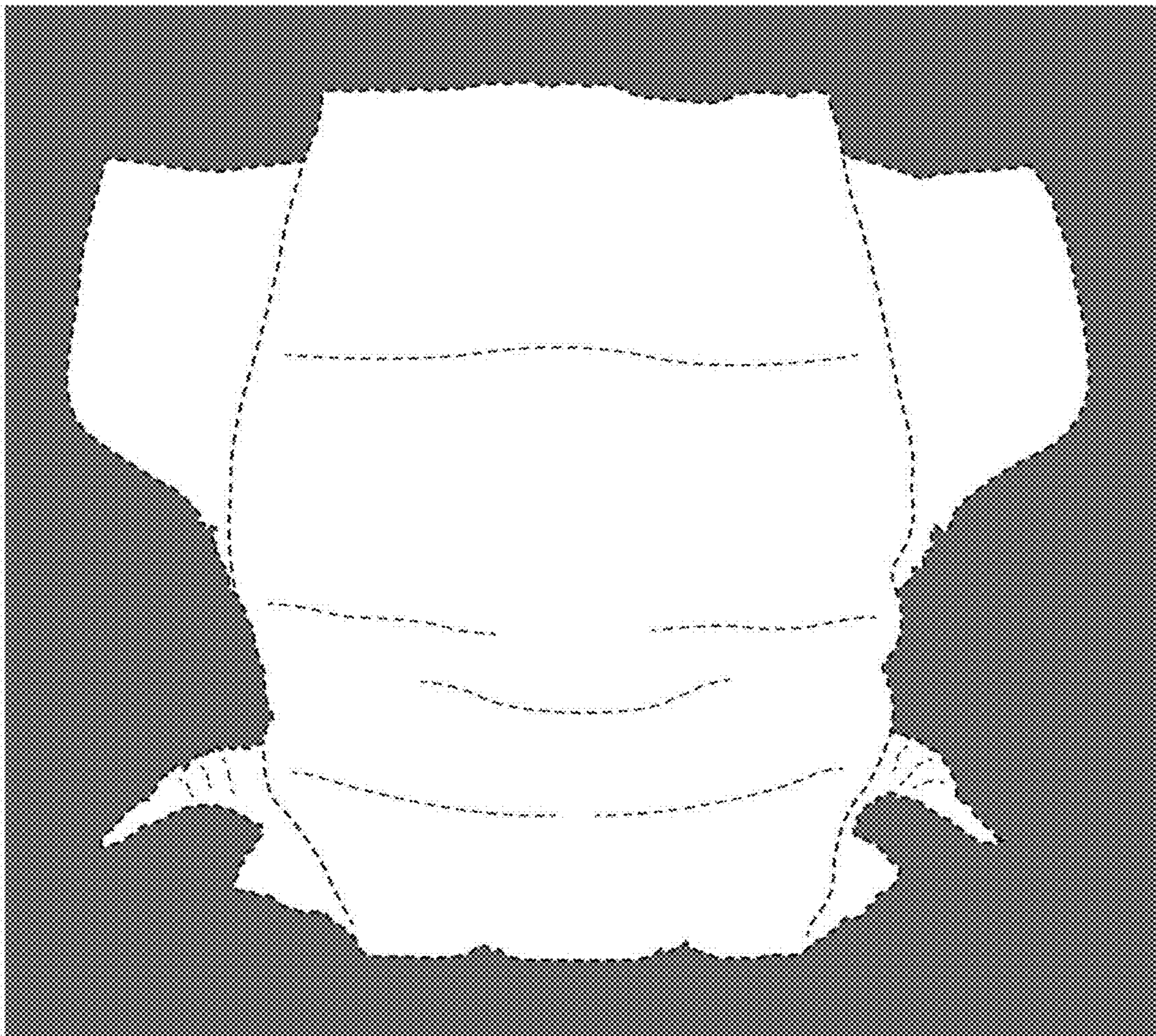

FIG. 22

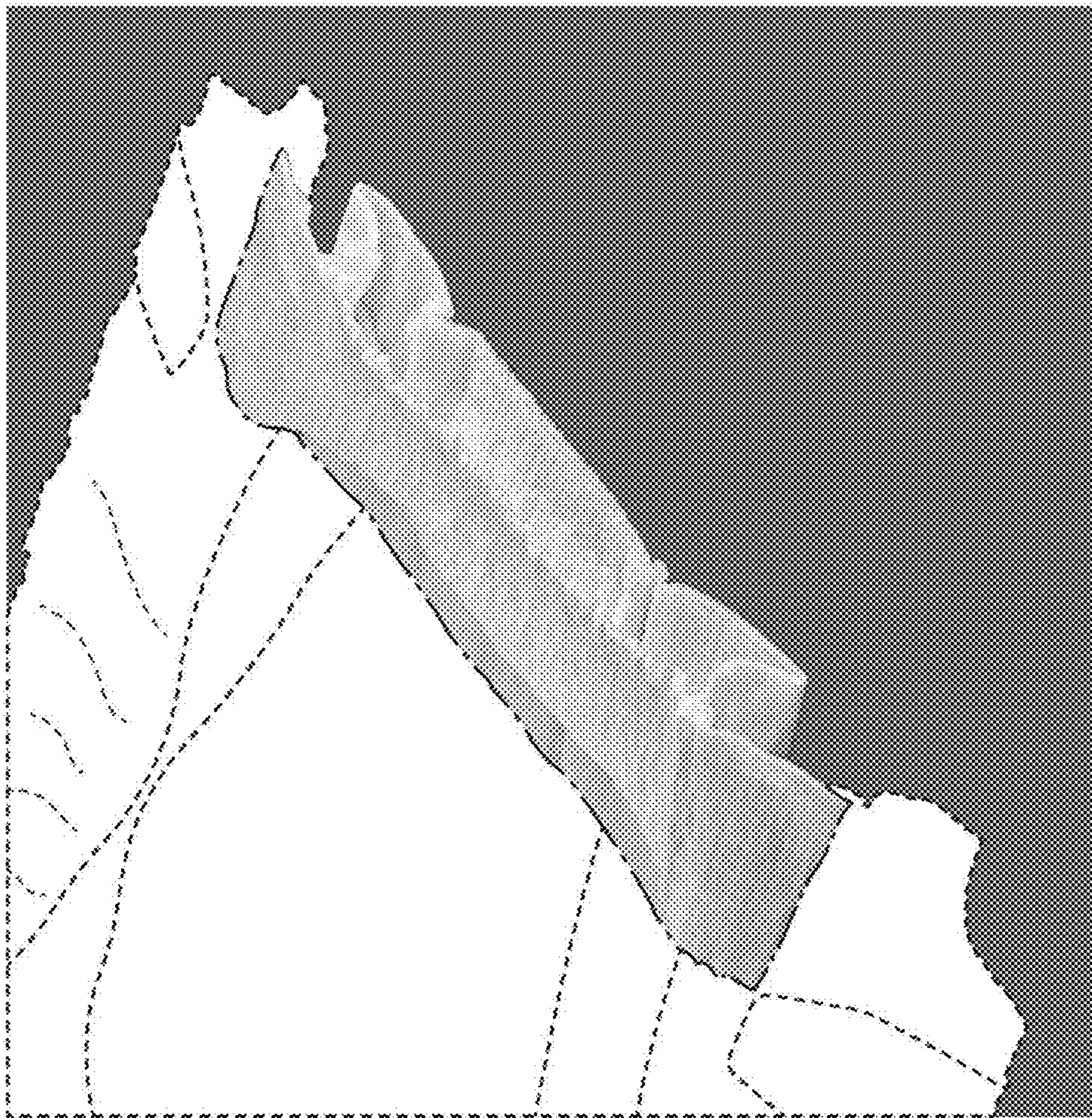

FIG. 23

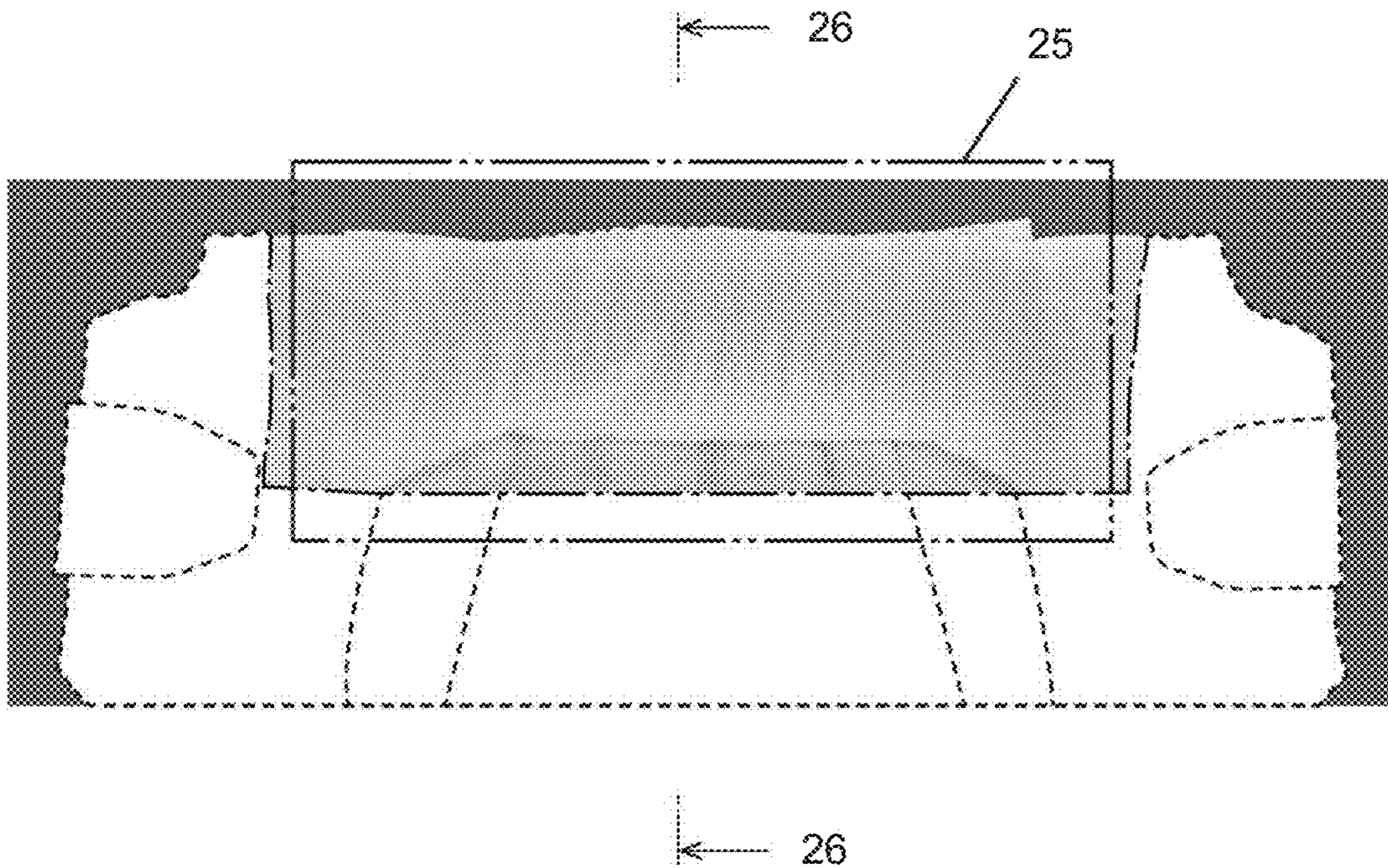

FIG. 24

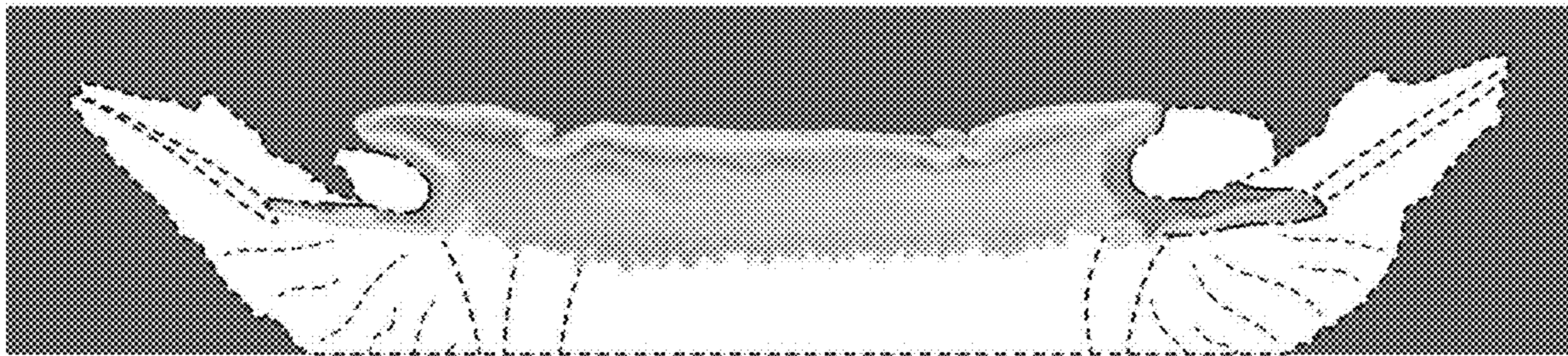

FIG. 25

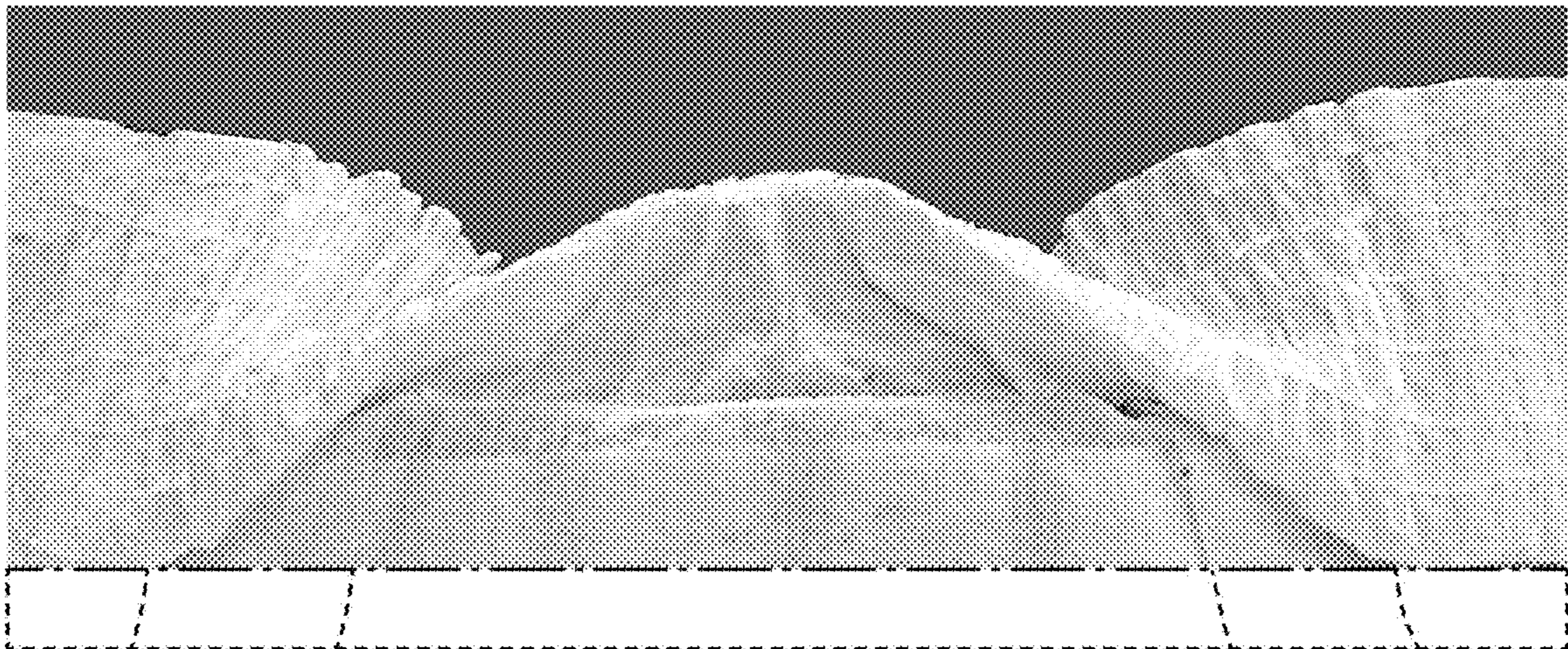

FIG. 26

