



US00D935581S

(12) **United States Design Patent** (10) **Patent No.:** **US D935,581 S**  
**Lee** (45) **Date of Patent:** **\*\* Nov. 9, 2021**

(54) **TOILET**

(71) Applicant: **Kohler Co.**, Kohler, WI (US)

(72) Inventor: **Dongha Lee**, Sheboygan, WI (US)

(73) Assignee: **Kohler Co.**, Kohler, WI (US)

(\*\*) Term: **15 Years**

(21) Appl. No.: **29/717,657**

(22) Filed: **Dec. 18, 2019**

(51) **LOC (13) Cl.** ..... **23-02**

(52) **U.S. Cl.**  
USPC ..... **D23/301**

(58) **Field of Classification Search**  
USPC ..... D23/295, 301, 309, 313  
See application file for complete search history.

(56) **References Cited**

**U.S. PATENT DOCUMENTS**

D379,217 S	5/1997	Kergoet	
D507,335 S	7/2005	Gordon	
D514,208 S	1/2006	Gordon	
D529,153 S	9/2006	Gordon	
D594,942 S	6/2009	Slothower et al.	
D601,233 S	9/2009	Kergoet	
D602,137 S	10/2009	Kergoet	
D641,459 S	7/2011	Corpuz, Jr. et al.	
D672,019 S *	12/2012	Bucher	D23/301
D806,842 S	1/2018	Goad	
D829,871 S *	10/2018	Garrels	D23/301
D882,739 S *	4/2020	Otsuka	D23/295
D884,849 S *	5/2020	Garrels	D23/309

**OTHER PUBLICATIONS**

Kohler—Cimarron Comfort Height Toilet Specification Sheet—  
Dec. 7, 2019; 2 pages.

\* cited by examiner

*Primary Examiner* — Robert A Delehanty

(74) *Attorney, Agent, or Firm* — Lempia Summerfield  
Katz LLC

(57) **CLAIM**

I claim the ornamental design for a toilet, as shown and  
described.

**DESCRIPTION**

FIG. 1 is a perspective view of an embodiment of the  
claimed design;  
FIG. 2 is a front view of the claimed design shown in FIG.  
1;  
FIG. 3 is a rear view of the claimed design shown in FIG.  
1;  
FIG. 4 is a side view of the claimed design shown in FIG.  
1;  
FIG. 5 is another side view of the claimed design shown in  
FIG. 1;  
FIG. 6 is a top view of the claimed design shown in FIG. 1;  
and,  
FIG. 7 is a bottom view of the claimed design shown in FIG.  
1.

The ornamental design which is claimed is shown in solid  
lines in the drawings. The broken lines in the drawings are  
for illustrative purposes only and form no part of the claimed  
design. Broken lines formed by unequal length dashes (i.e.,  
dash-dot) define bounds of the claimed design.

**1 Claim, 7 Drawing Sheets**

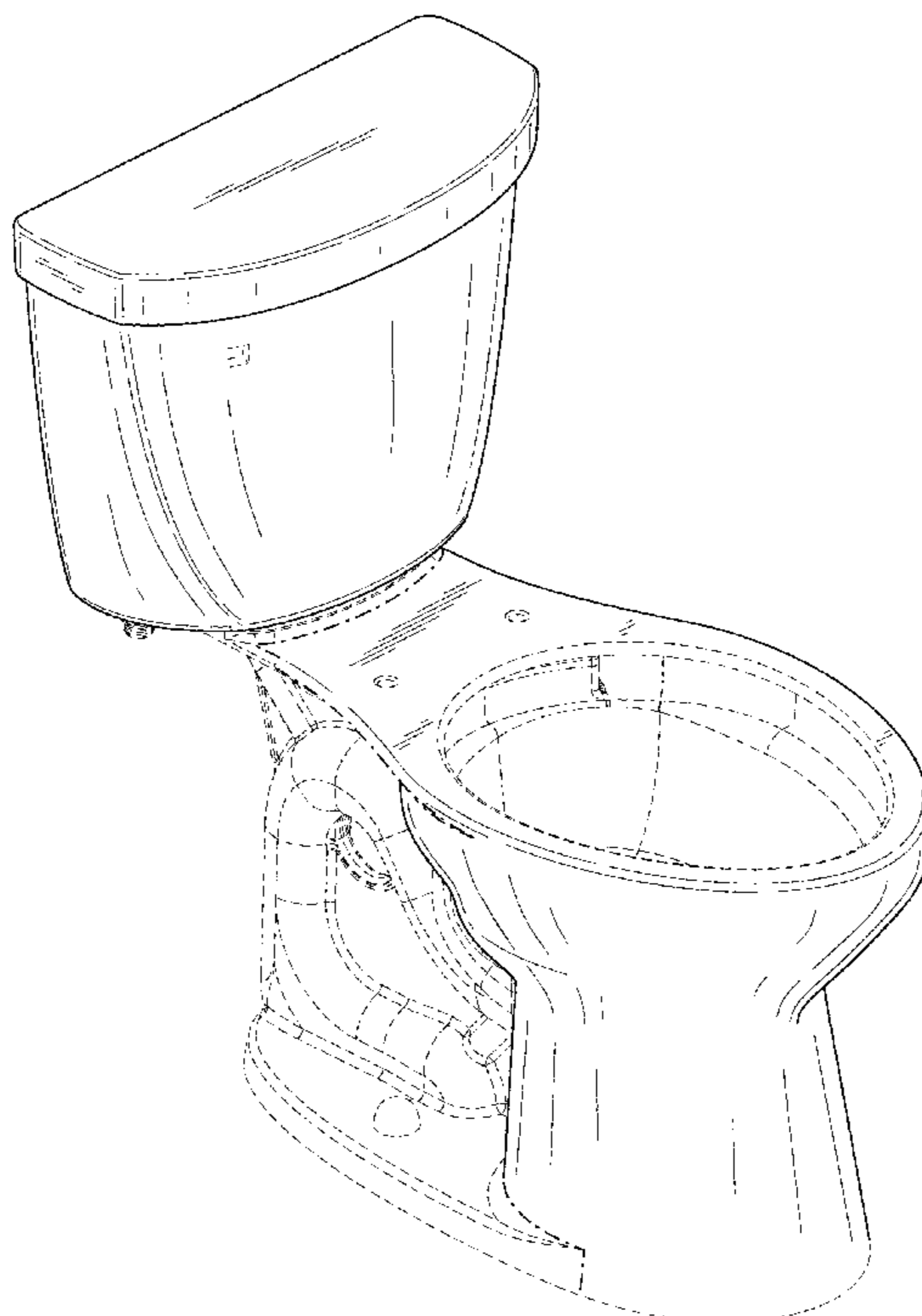

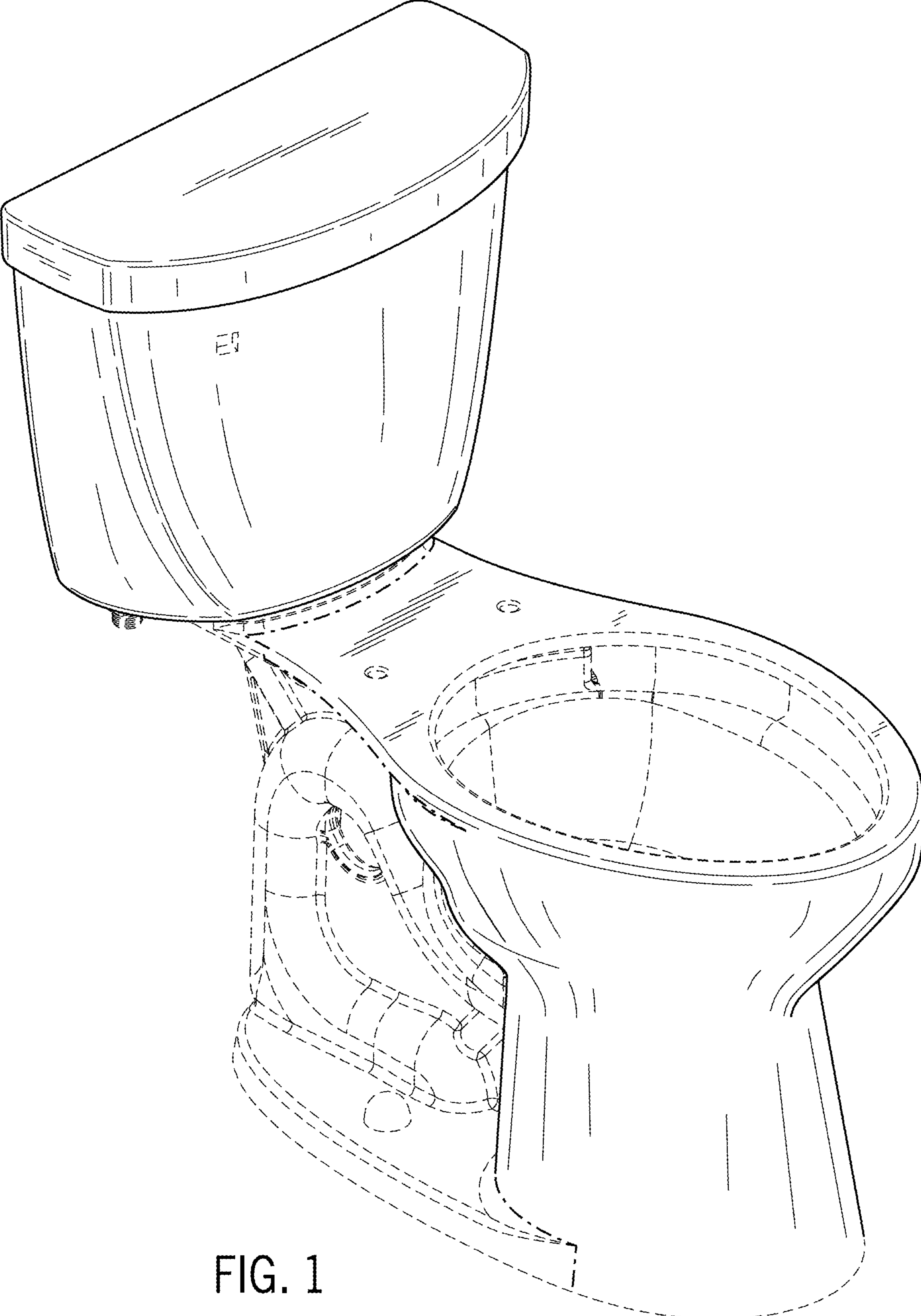

FIG. 1

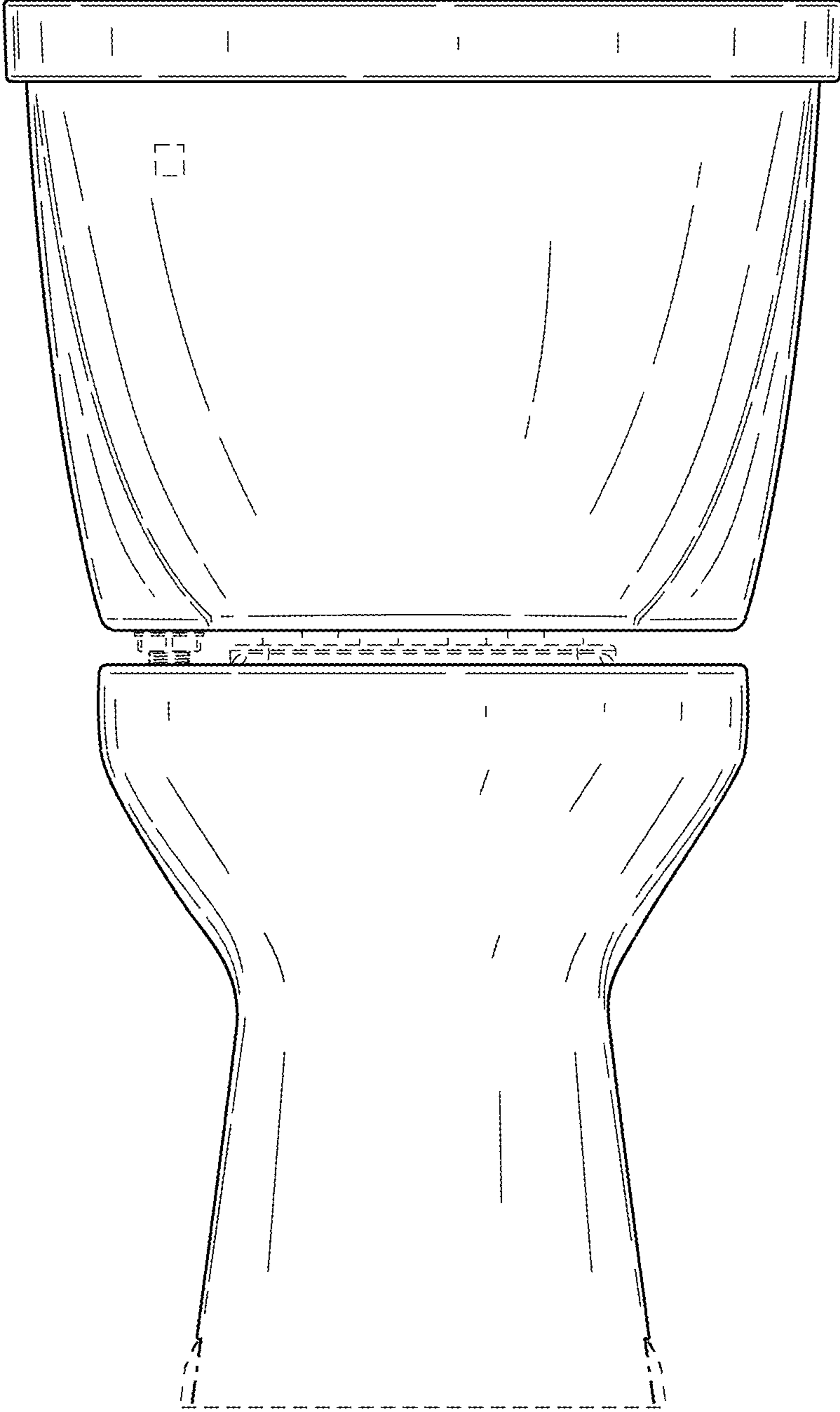

FIG. 2

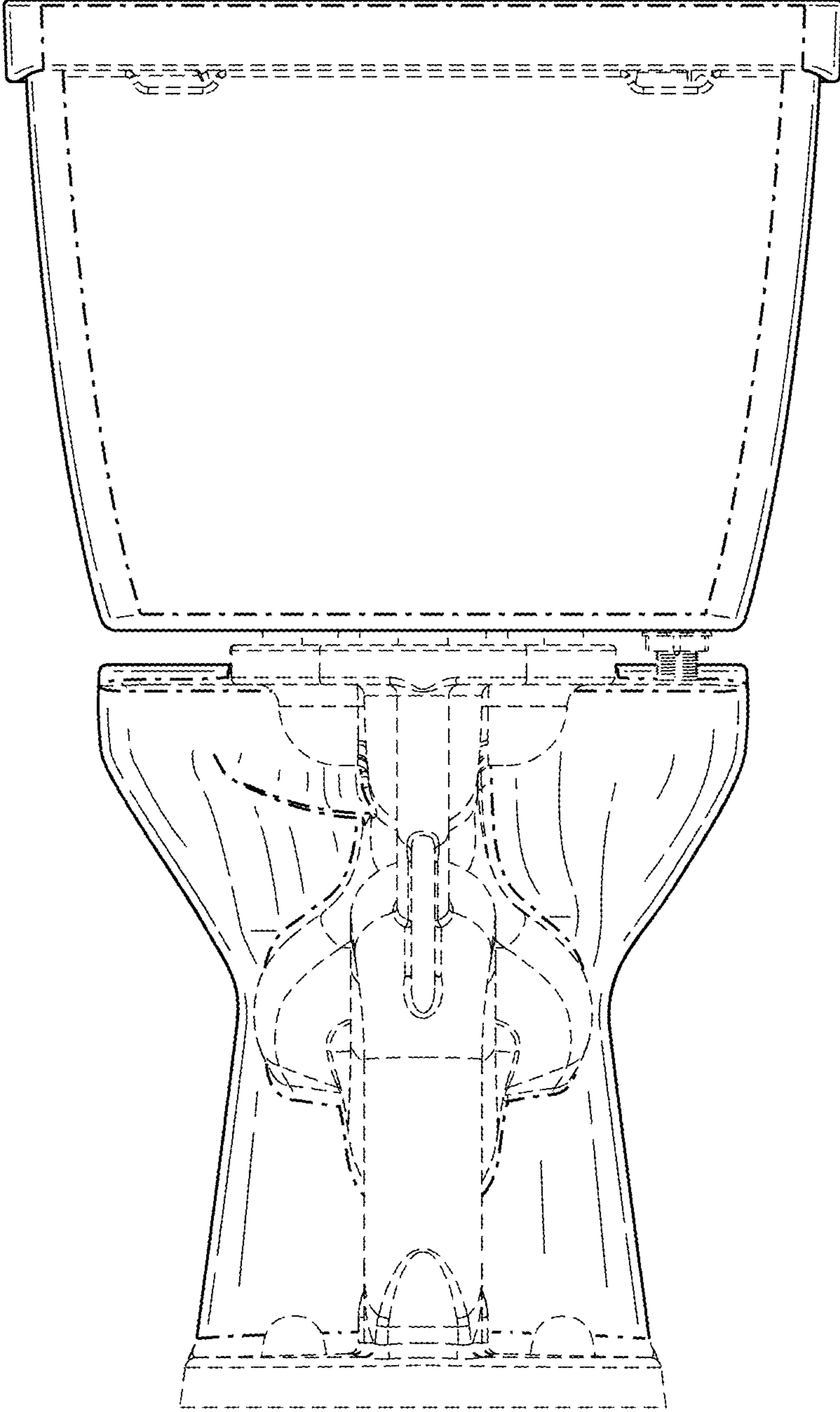

FIG. 3

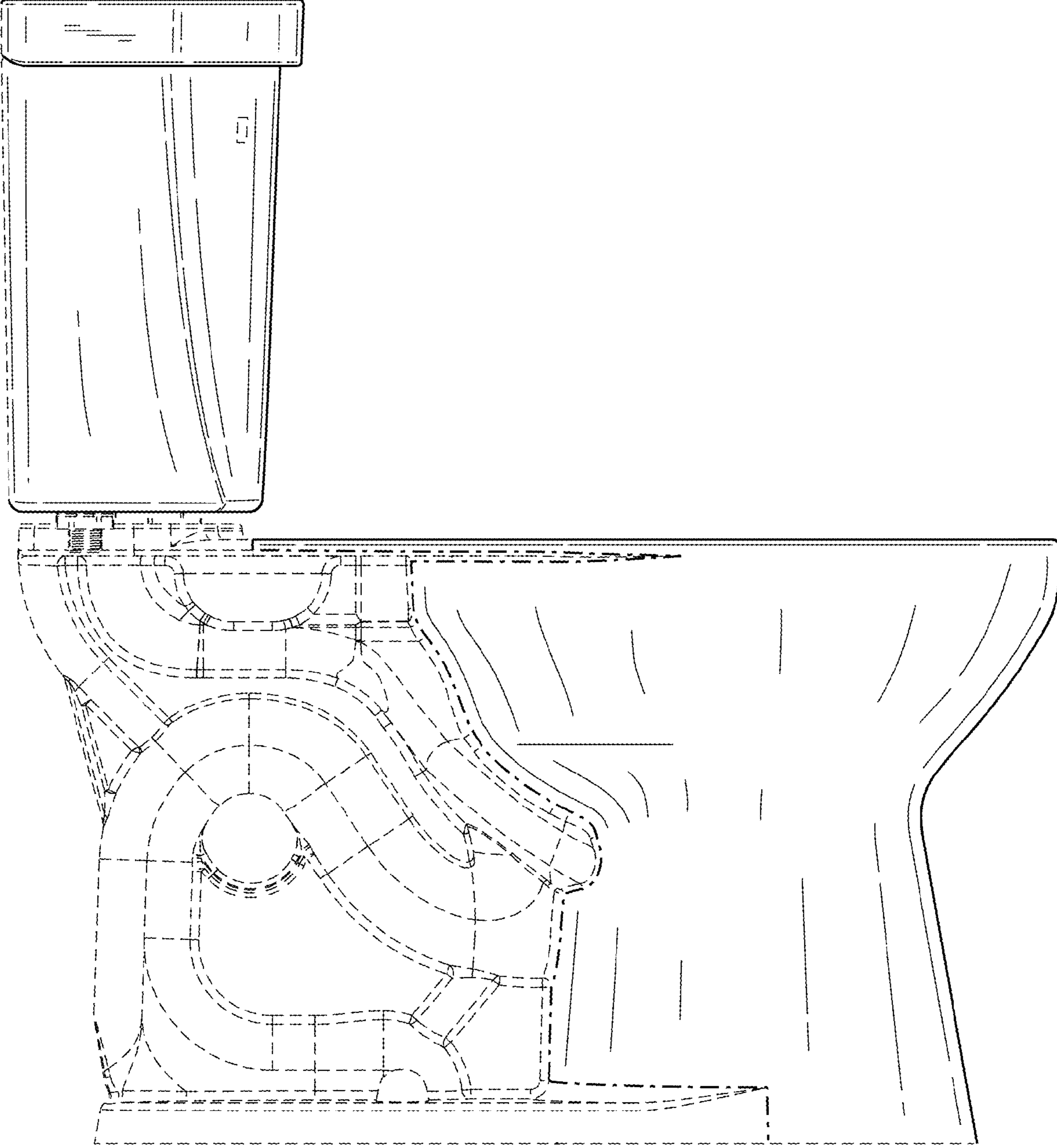

FIG. 4

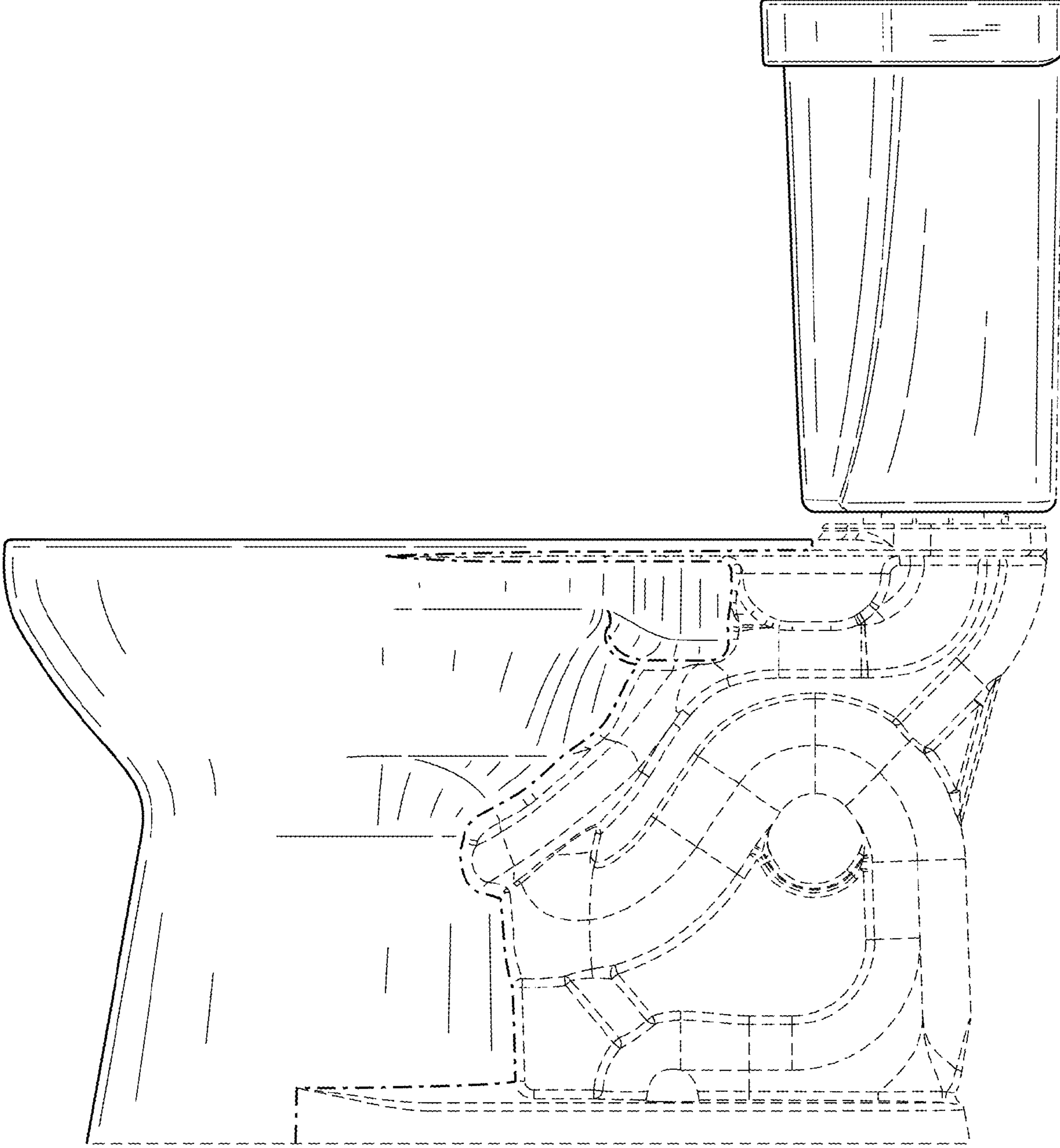

FIG. 5

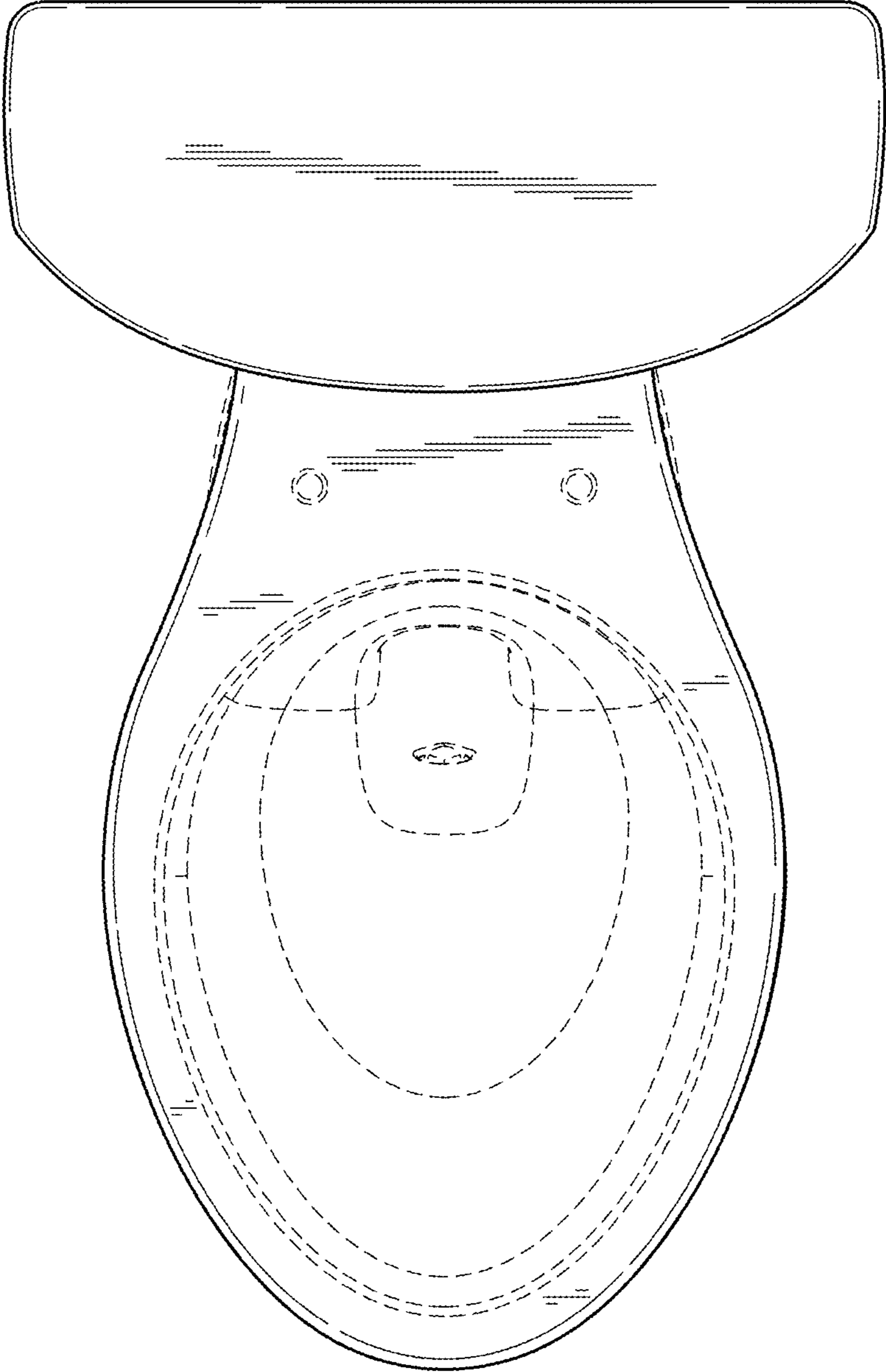

FIG. 6

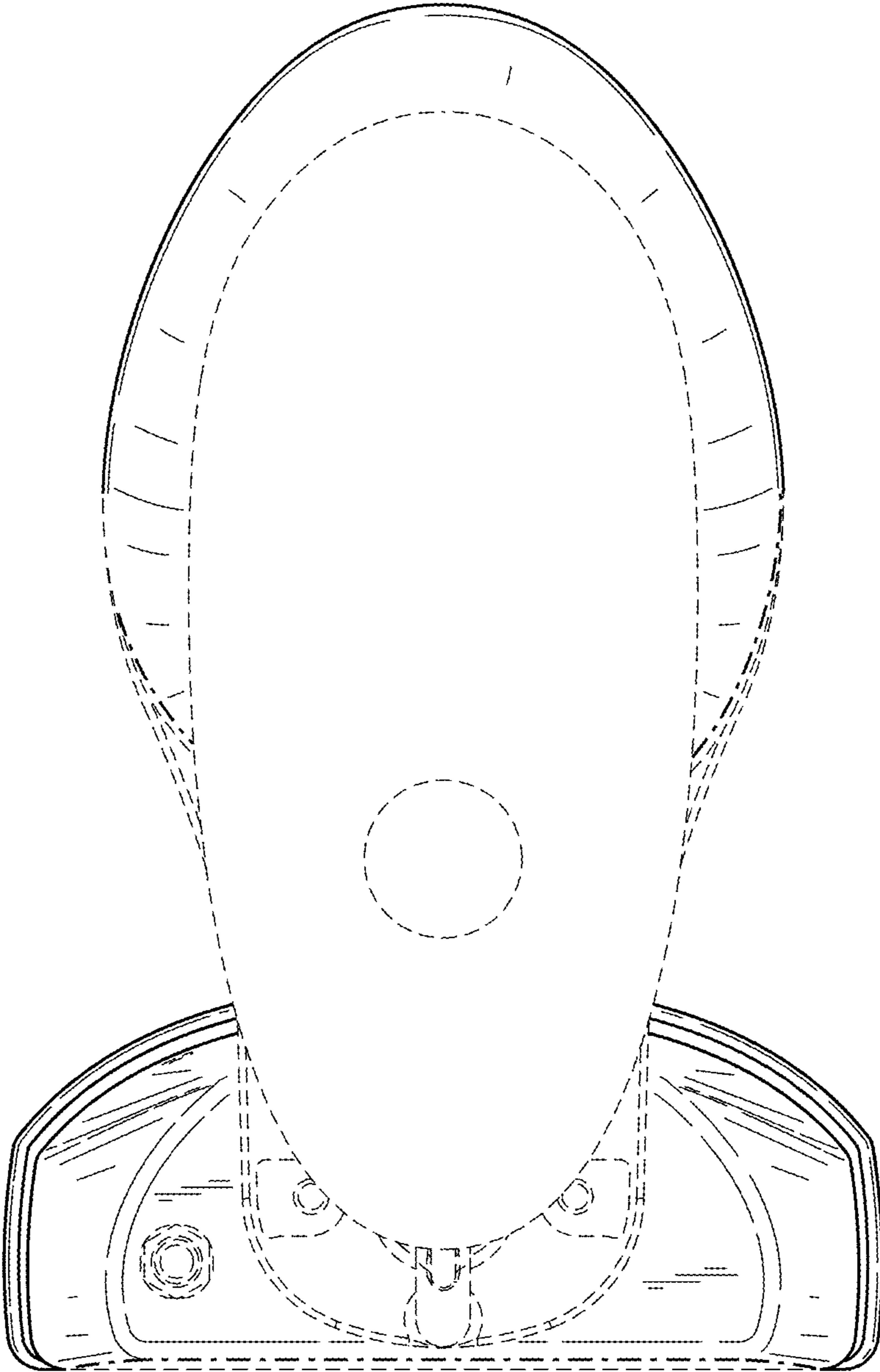

FIG. 7