



US00D935559S

(12) **United States Design Patent** (10) **Patent No.:** **US D935,559 S**
He (45) **Date of Patent:** **** Nov. 9, 2021**

(54) **SHOWER HEAD**

D849,191 S 5/2019 Cocks et al.
D851,207 S 6/2019 Cocks et al.
D888,195 S 6/2020 Cocks et al.

(71) Applicant: **Long He**, Ganzhou (CN)

(72) Inventor: **Long He**, Ganzhou (CN)

(**) Term: **15 Years**

FOREIGN PATENT DOCUMENTS

GB 6052659 * 1/2019
JP D2019-732 * 3/2019

(21) Appl. No.: **29/754,428**

OTHER PUBLICATIONS

(22) Filed: **Oct. 10, 2020**

Chrider Shower Head found on Mar. 23, 2021 at <https://www.amazon.com/Chrider-Handheld-Detachable-Showerhead-Adjustable/dp/B07SGLSS29/> (Year: 2019).*

(51) **LOC (13) Cl.** **23-01**

(52) **U.S. Cl.**

USPC **D23/226**

(58) **Field of Classification Search**

USPC D23/213, 223, 229, 239, 255, 283, 304,
D23/226

CPC .. A62C 1/02; A62C 1/03; B05B 1/304; B65D
47/32

See application file for complete search history.

* cited by examiner

Primary Examiner — Karen S Acker
Assistant Examiner — Jonathan Emil Fiencke

(57) **CLAIM**

The ornamental design for a shower head, as shown and described.

(56) **References Cited**

DESCRIPTION

U.S. PATENT DOCUMENTS

D421,482 S * 3/2000 Milrud D23/223
D457,937 S * 5/2002 Lindholm D23/223
D488,534 S * 4/2004 Lin D23/223
D503,774 S * 4/2005 Zieger D23/223
D529,988 S * 10/2006 Tse D23/223
D529,989 S * 10/2006 Tse D23/223
D531,264 S * 10/2006 Tse D23/223
D547,420 S * 7/2007 Lobermeier D23/223
D547,421 S * 7/2007 Lobermeier D23/223
D562,941 S * 2/2008 Pan D23/223
D562,942 S * 2/2008 Pan D23/223
D580,513 S * 11/2008 Quinn D23/223
D659,796 S * 5/2012 Farley D23/223

FIG. 1 is a first perspective view of a shower head showing my new design;

FIG. 2 is a second perspective view thereof;

FIG. 3 is a front view thereof;

FIG. 4 is a back view thereof;

FIG. 5 is a left side view thereof;

FIG. 6 is a right side view thereof;

FIG. 7 is a top view thereof; and,

FIG. 8 is a bottom view thereof.

The broken lines shown in the drawings depict portions of the shower head that form no part of the claimed design.

1 Claim, 8 Drawing Sheets

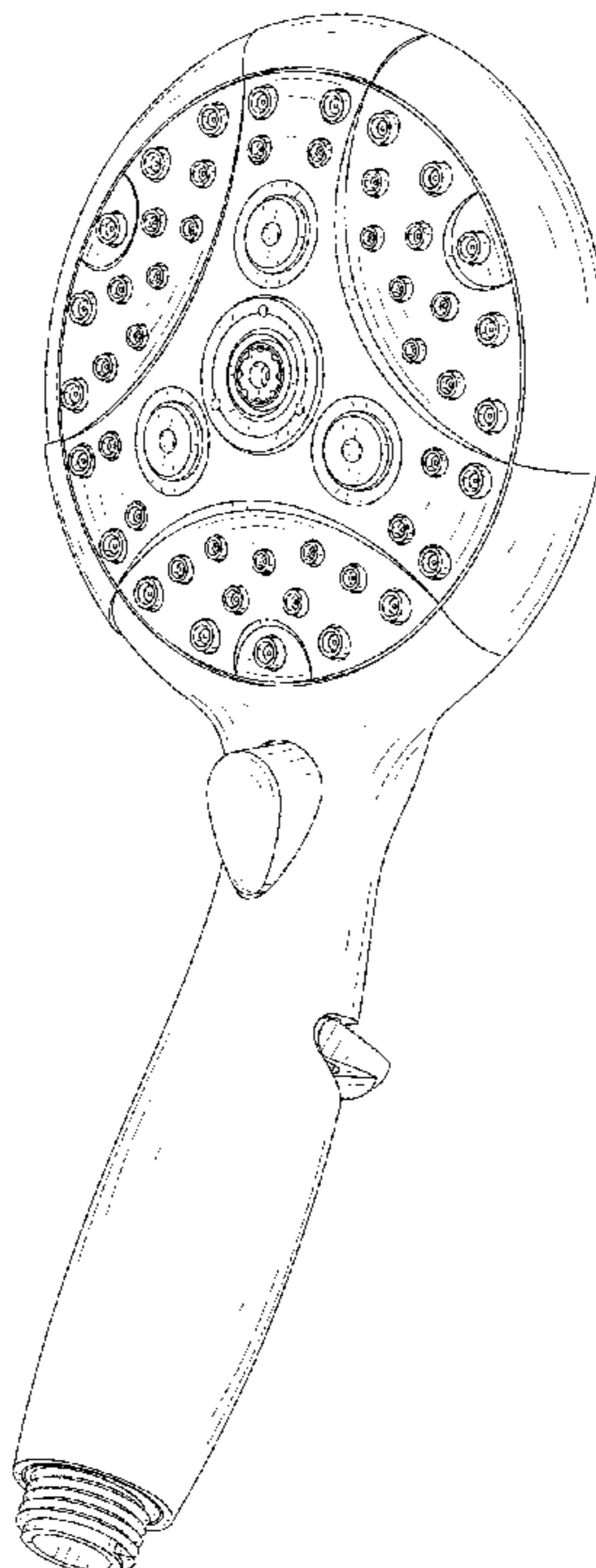

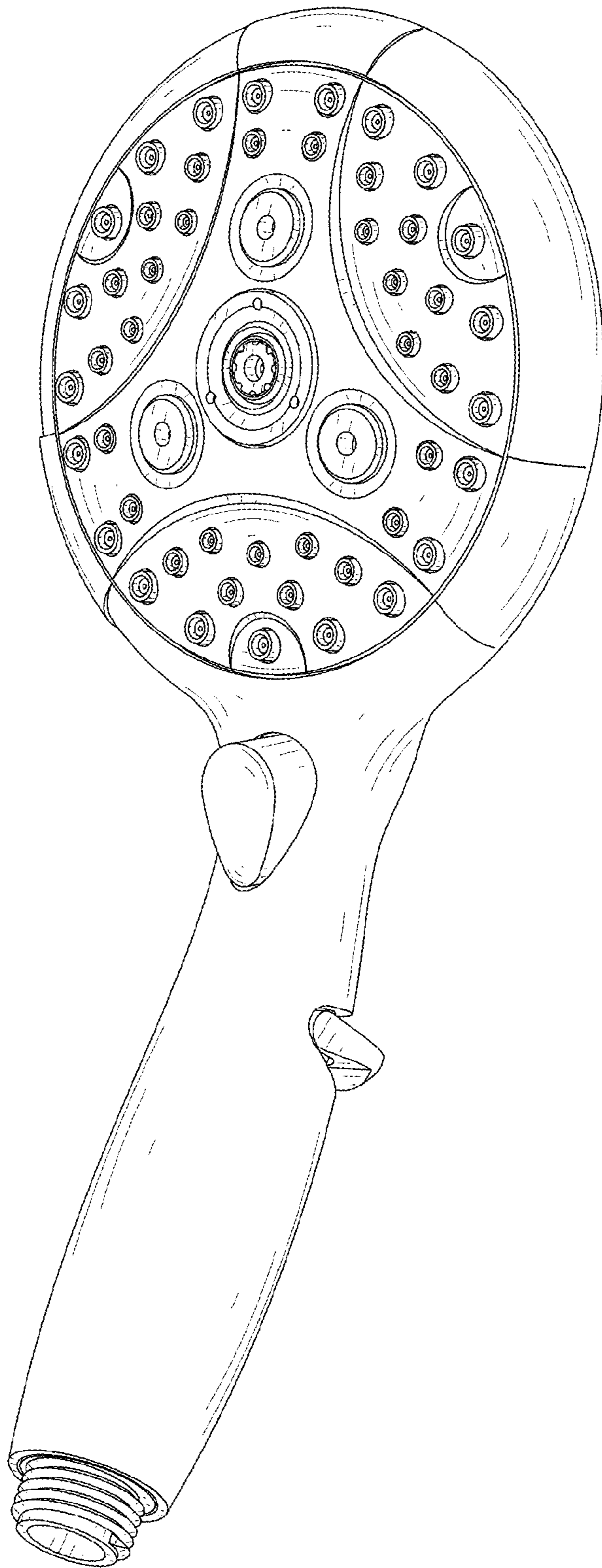

FIG. 1

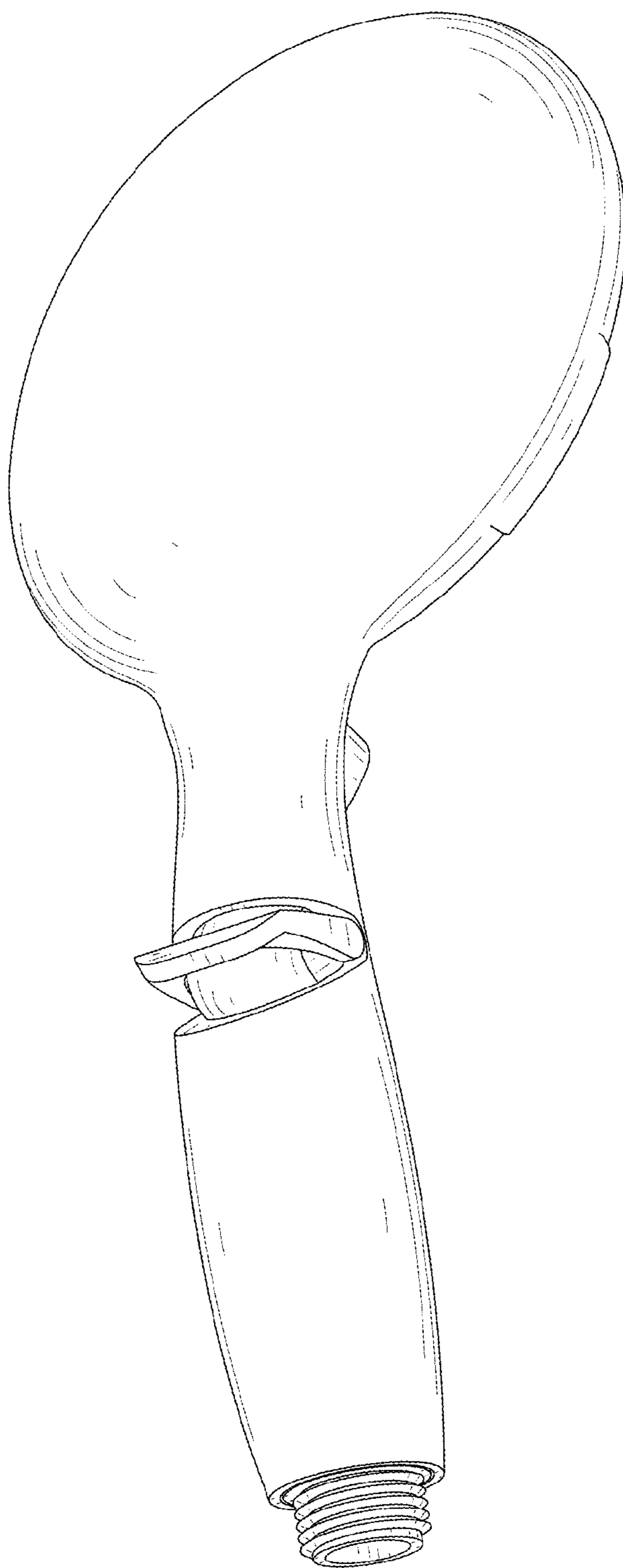

FIG. 2

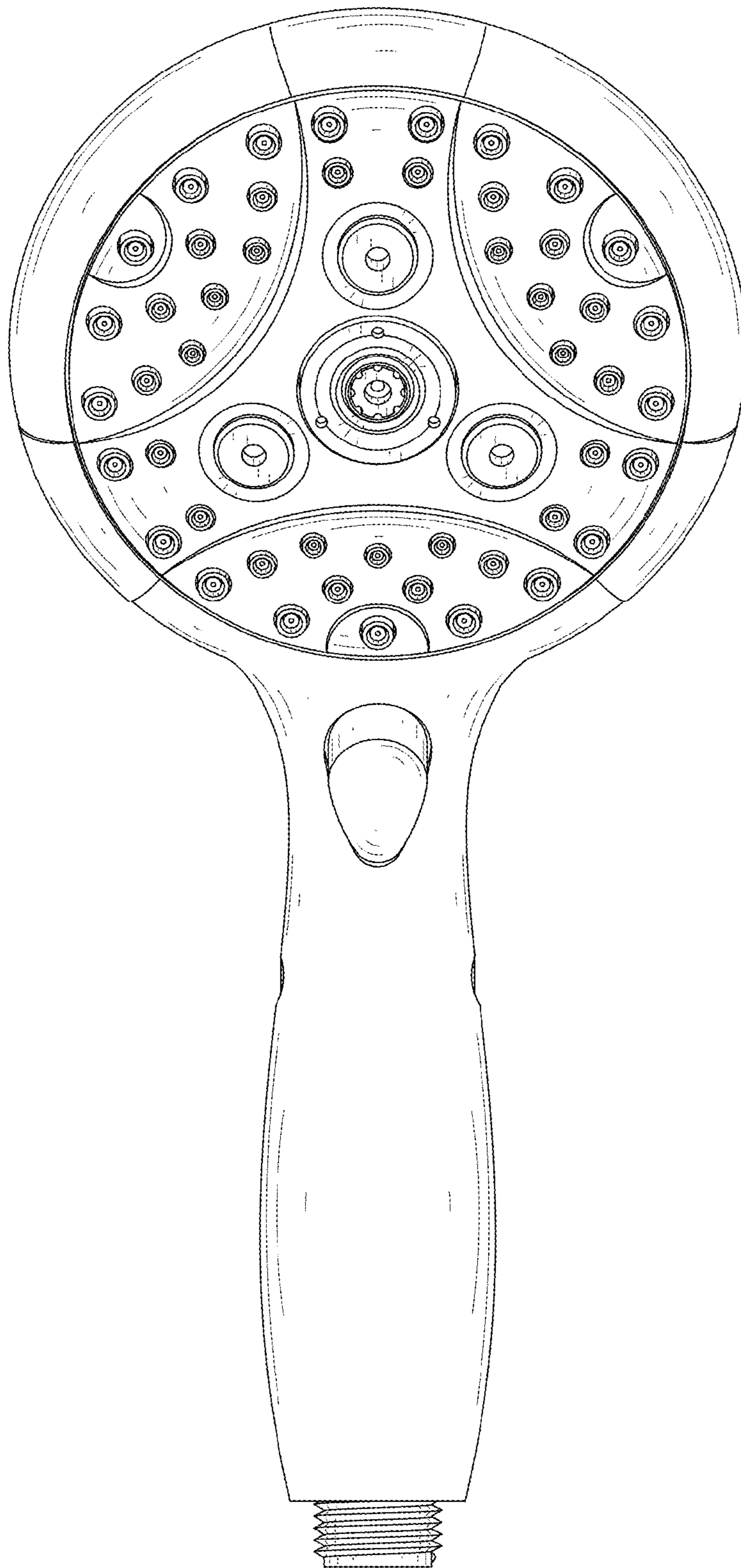

FIG. 3

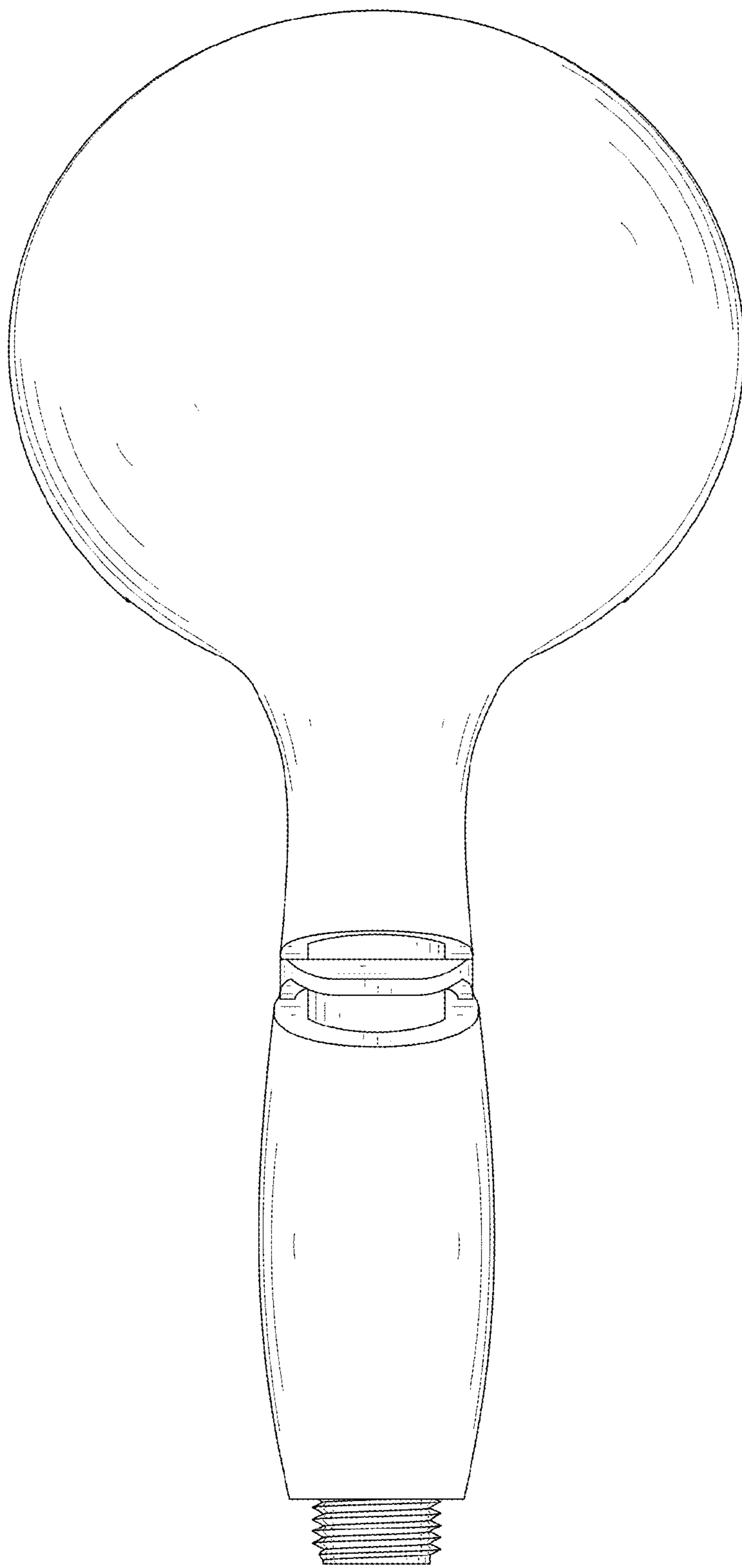

FIG. 4

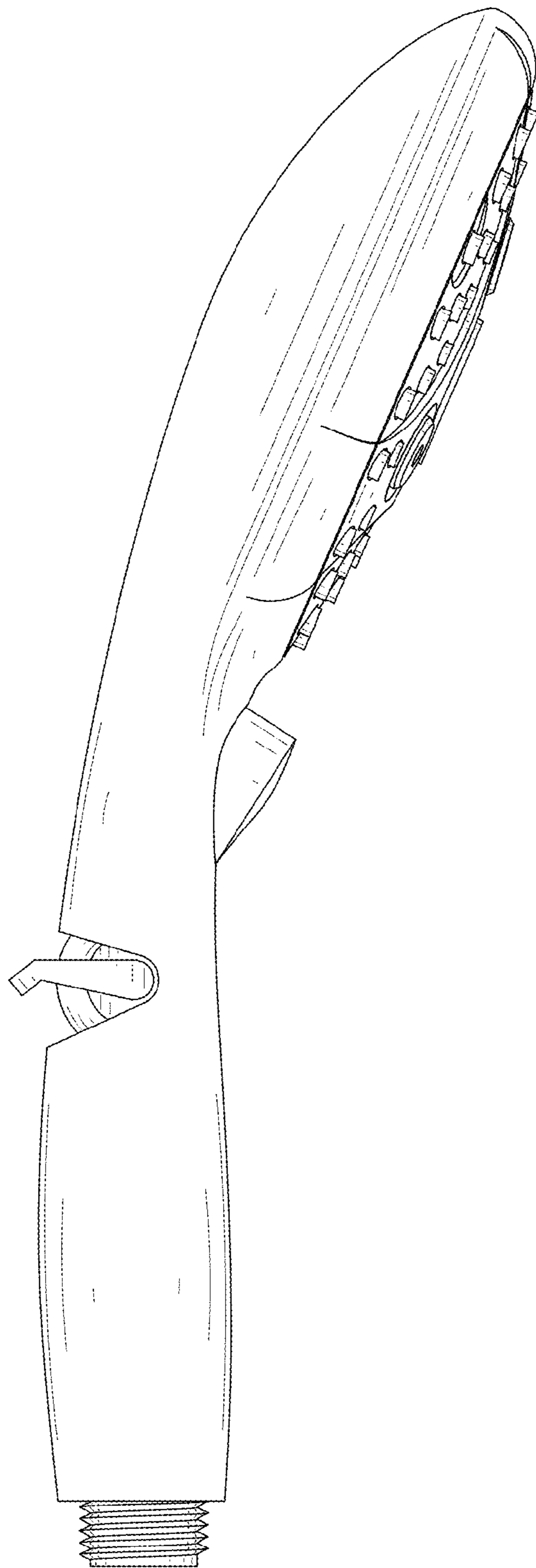

FIG. 5

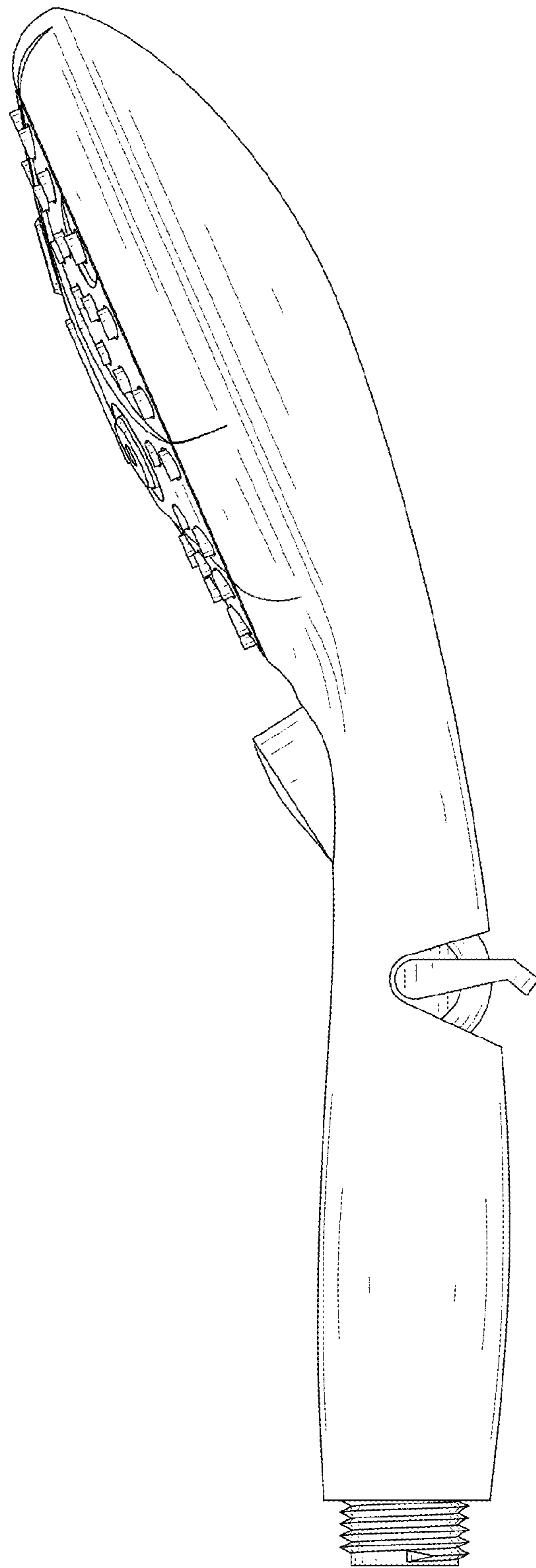

FIG. 6

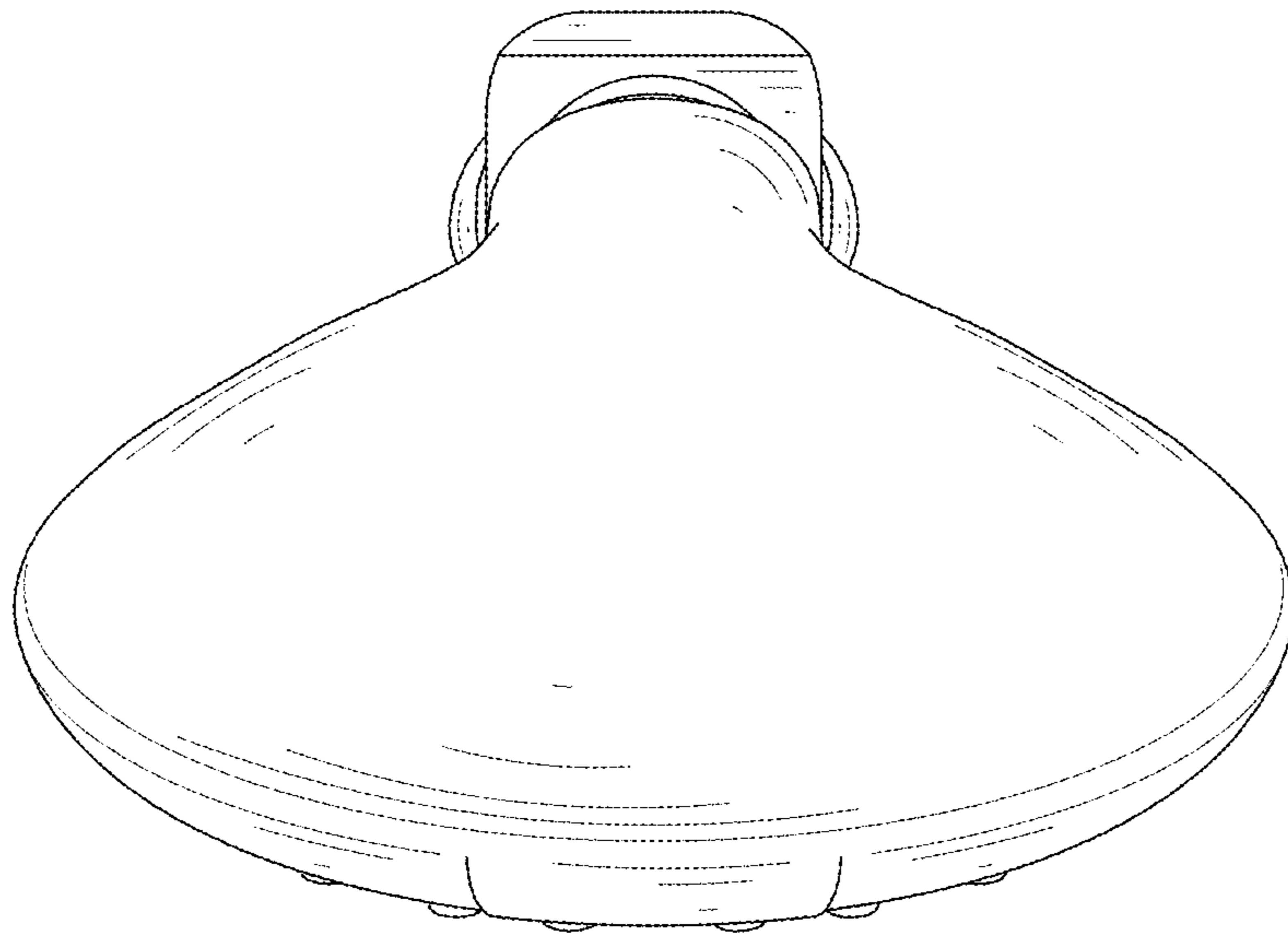

FIG. 7

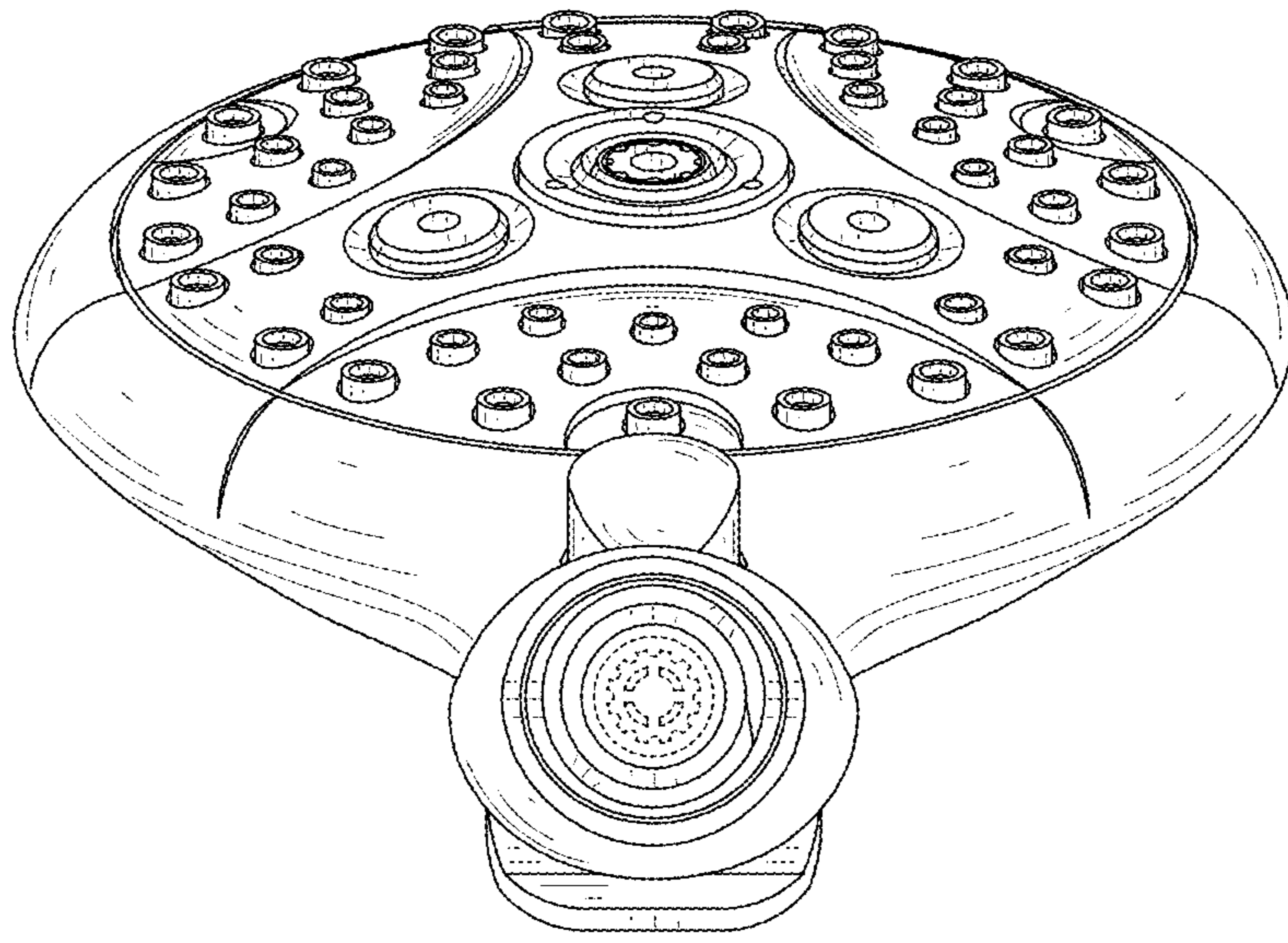

FIG. 8



US00D935559C1

(12) **EX PARTE REEXAMINATION CERTIFICATE** (12368th)
United States Patent
He

(10) **Number:** **US D935,559 C1**

(45) **Certificate Issued:** **Aug. 17, 2023**

(54) **SHOWER HEAD**

(71) Applicant: **Long He**, Ganzhou (CN)

(72) Inventor: **Long He**, Ganzhou (CN)

Reexamination Request:

No. 90/015,107, Aug. 30, 2022

Reexamination Certificate for:

Patent No.: **Des. 935,559**

Issued: **Nov. 9, 2021**

Appl. No.: **29/754,428**

Filed: **Oct. 10, 2020**

(51) **LOC (14) Cl.** **23-01**

(52) **U.S. Cl.**

USPC **D23/226**

(58) **Field of Classification Search**

USPC D23/213, 219, 226, 239, 283, 304

CPC .. B05B 1/00; B05B 1/02; B05B 1/005; B05B

1/14; B05B 1/18; B05B 1/185

See application file for complete search history.

(56)

References Cited

To view the complete listing of prior art documents cited during the proceeding for Reexamination Control Number 90/015,107, please refer to the USPTO's Patent Electronic System.

Primary Examiner — Philip S Hyder

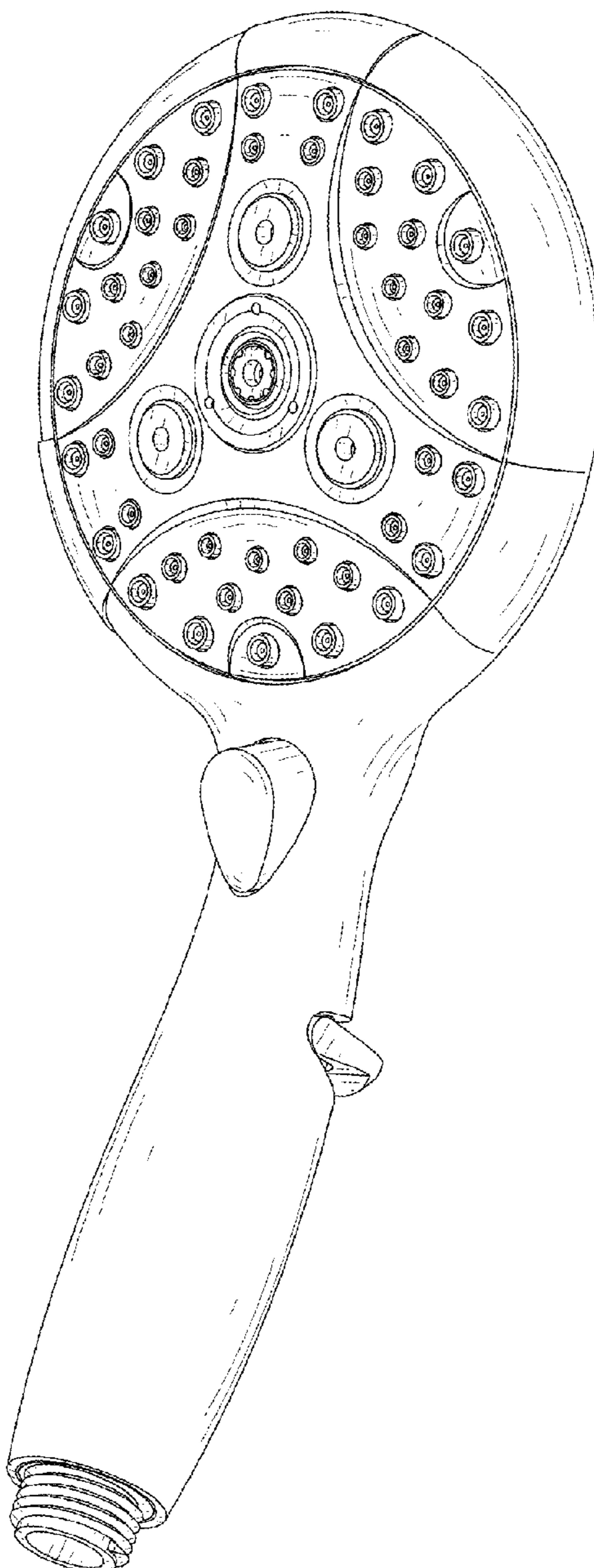

1
EX PARTE
REEXAMINATION CERTIFICATE

THE PATENT IS HEREBY AMENDED AS 5
INDICATED BELOW.

AS A RESULT OF REEXAMINATION, IT HAS BEEN
DETERMINED THAT:

The claim 1 is cancelled. 10

* * * * *