



US00D935518S

(12) **United States Design Patent** (10) **Patent No.:** **US D935,518 S**
Lamb et al. (45) **Date of Patent:** **** Nov. 9, 2021**

(54) **KEYBOARD INSTRUMENT**
(71) Applicant: **ROLI Ltd.**, London (GB)
(72) Inventors: **Roland Oliver Lamb**, London (GB);
Rami Naayem, London (GB);
Hong-Yeul Eom, London (GB)
(73) Assignee: **Roli Ltd.**, London (GB)
(**) Term: **15 Years**
(21) Appl. No.: **29/703,125**
(22) Filed: **Aug. 23, 2019**

7,465,868 B2 * 12/2008 Lengeling G10H 1/34
84/719
D768,231 S * 10/2016 Kirsh D17/2
D777,243 S * 1/2017 McMillen D17/1
D778,342 S * 2/2017 Washio D17/1
D809,588 S * 2/2018 Eom D17/1
D814,555 S * 4/2018 Poole D17/1
D835,181 S * 12/2018 Rosenberg D17/1
2005/0241467 A1 * 11/2005 Lo G10H 1/344
84/744
2009/0266218 A1 * 10/2009 Parienti G10C 3/12
84/171
2015/0000504 A1 * 1/2015 Bell G10C 3/12
84/440
2018/0330705 A1 * 11/2018 Palmowski G06F 3/0412
* cited by examiner

(30) **Foreign Application Priority Data**

Feb. 25, 2019 (EM) 006267167-0001
Feb. 25, 2019 (EM) 006267167-0002
Feb. 25, 2019 (EM) 006267167-0003
Feb. 25, 2019 (EM) 006267167-0004
Mar. 1, 2019 (EM) 006272910-0001
Mar. 1, 2019 (EM) 006272910-0002
Mar. 1, 2019 (EM) 006272910-0003

Primary Examiner — R. Johnson

(57) **CLAIM**

The ornamental design for a keyboard instrument, as shown and described.

(51) **LOC (13) Cl.** **17-01**
(52) **U.S. Cl.**
USPC **D17/1**
(58) **Field of Classification Search**
USPC D17/1, 2, 7, 99; D21/405, 409, 411;
D14/203.1
CPC G10C 1/00; G10C 3/00; G10C 3/12
See application file for complete search history.

DESCRIPTION

FIG. 1 is a top view of a keyboard instrument showing our new design;
FIG. 2 is a bottom view thereof;
FIG. 3 is a front view thereof;
FIG. 4 is a rear view thereof;
FIG. 5 is a left side view thereof;
FIG. 6 is a right side view thereof; and,
FIG. 7 is a front, right and top perspective view thereof.
The broken lines shown in the figures form no part of the claimed design.

(56) **References Cited**

U.S. PATENT DOCUMENTS

D313,238 S * 12/1990 Saraceni D17/7
D569,415 S * 5/2008 Shigeru D17/1

1 Claim, 4 Drawing Sheets

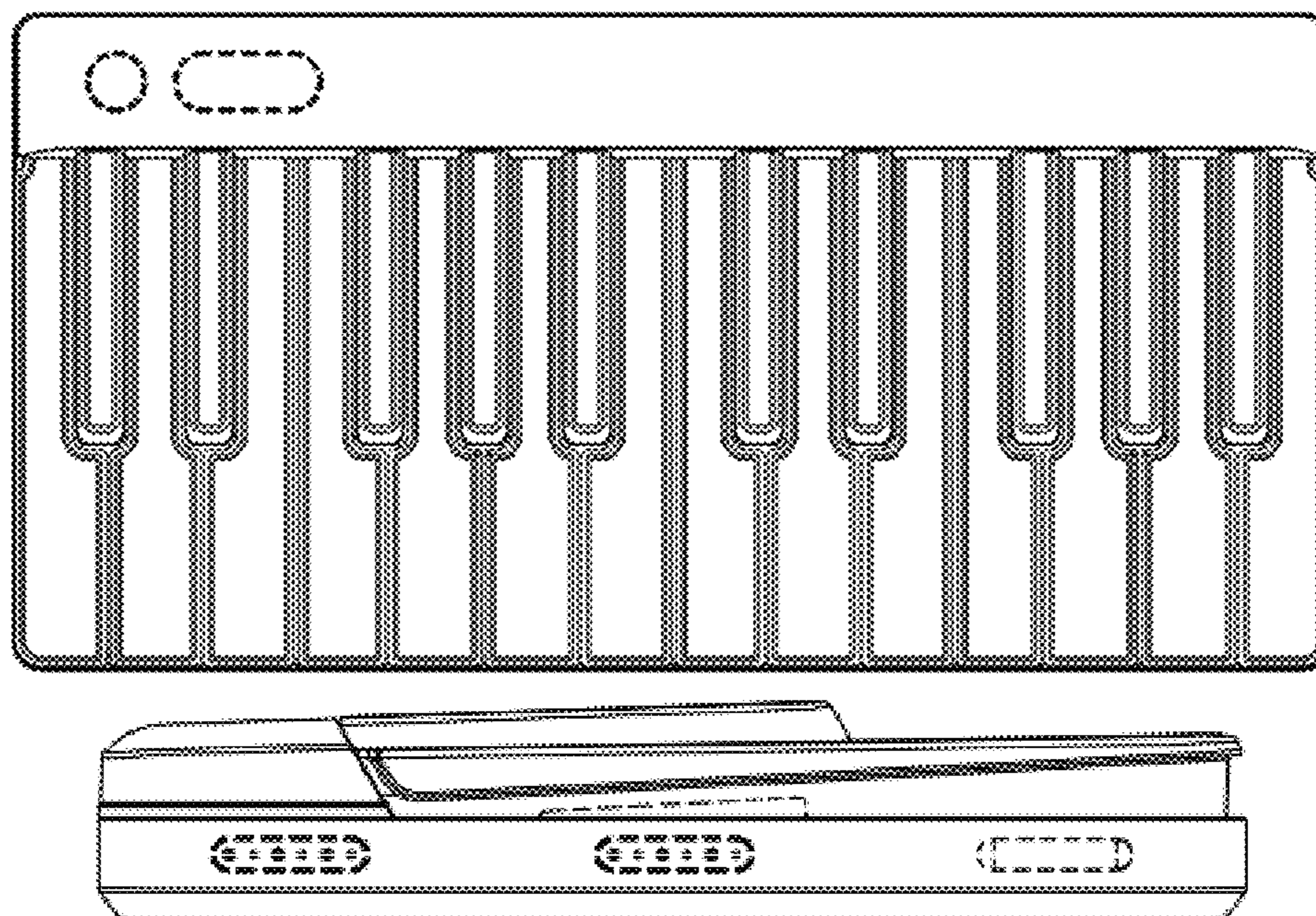

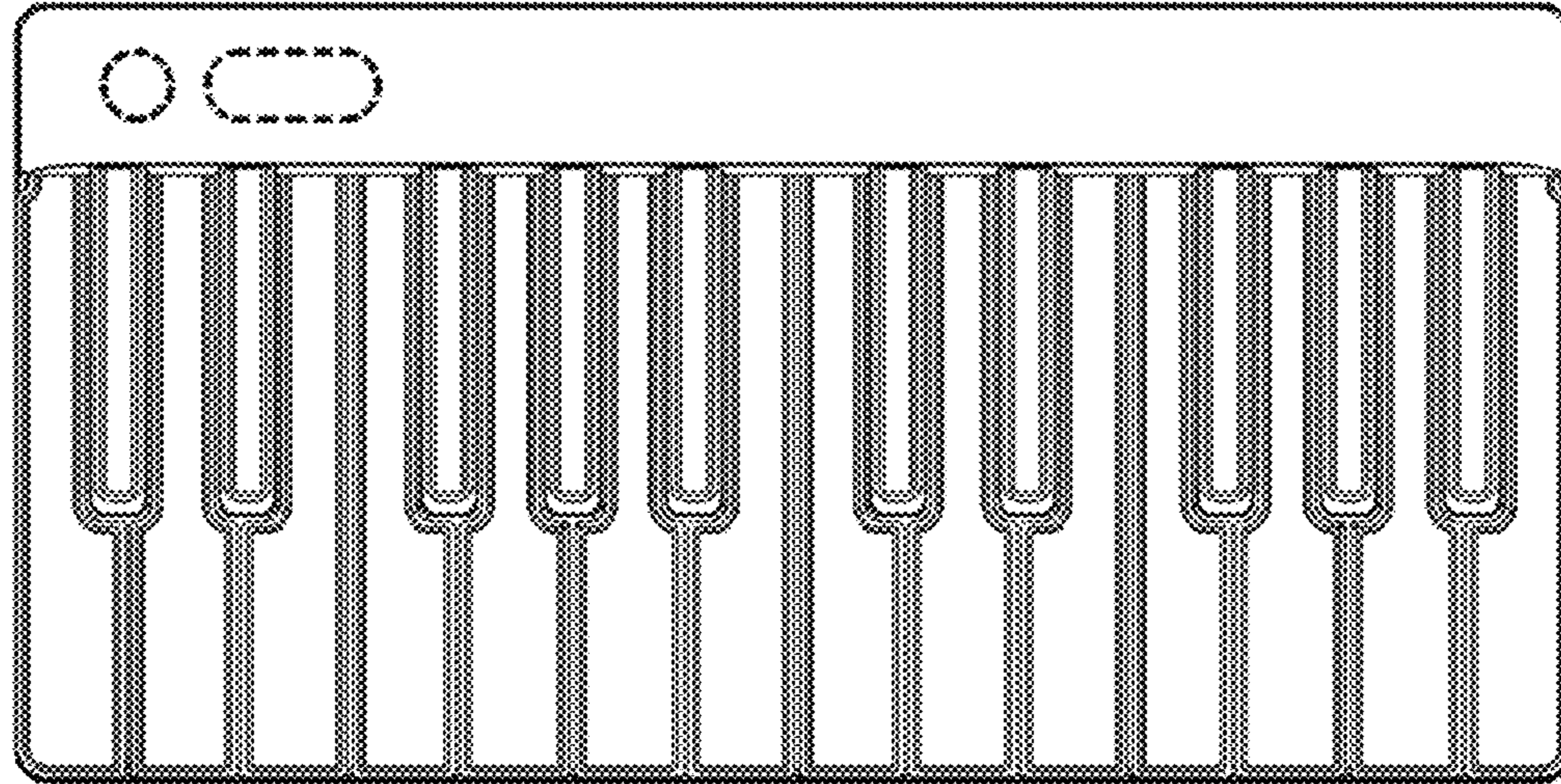

FIG. 1

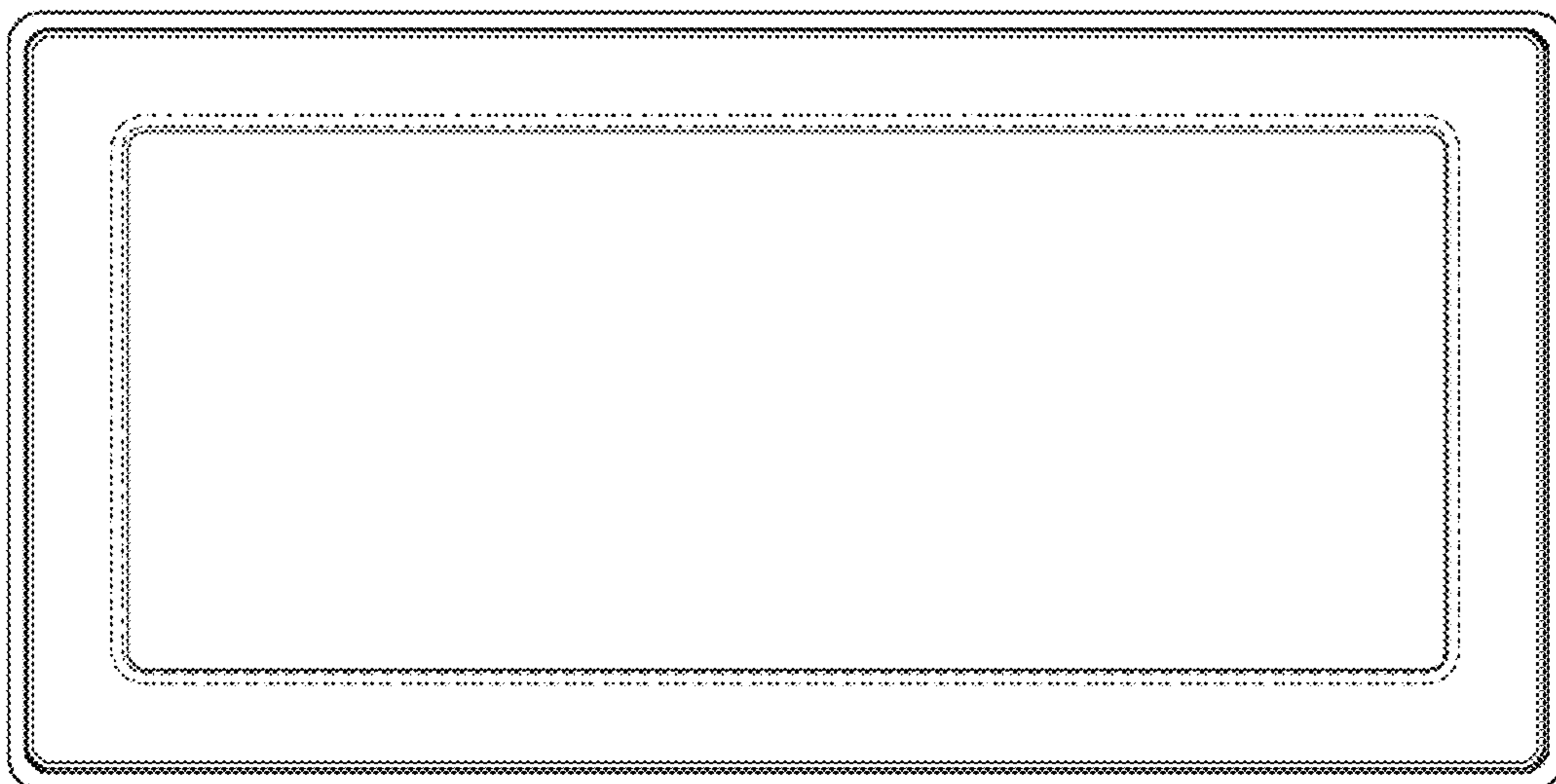

FIG. 2

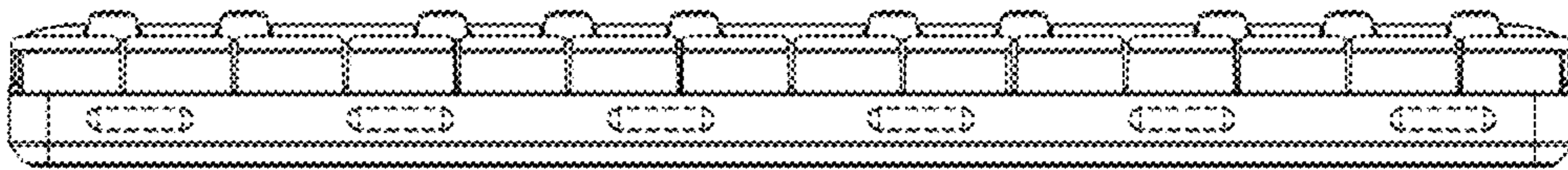

FIG. 3

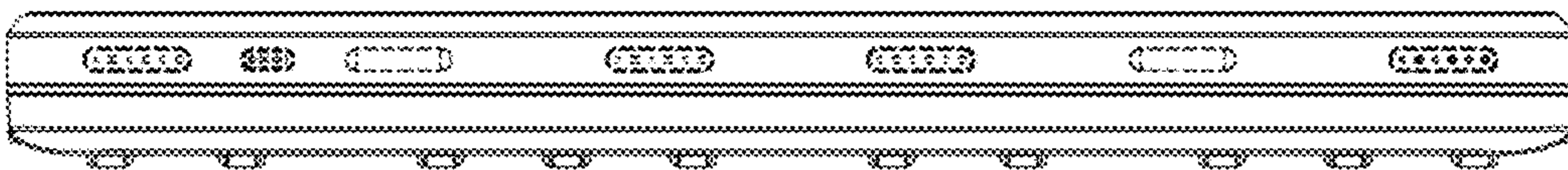

FIG. 4

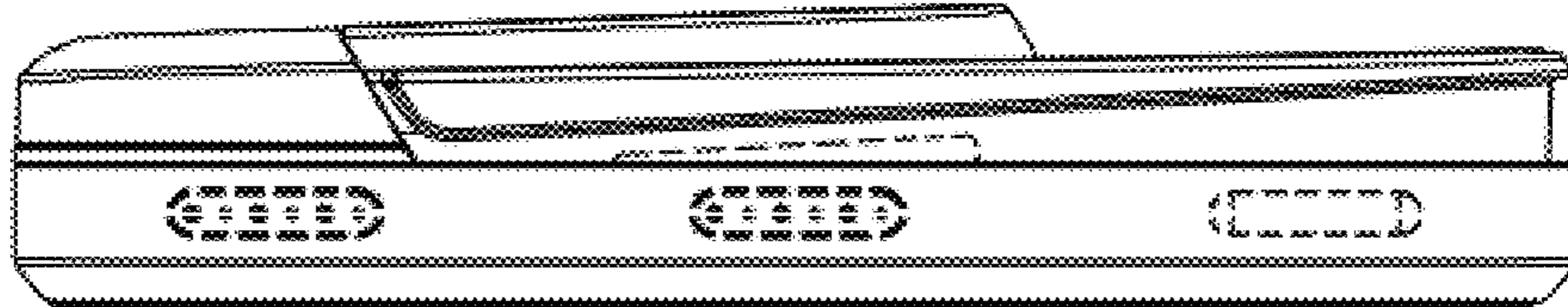

FIG. 5

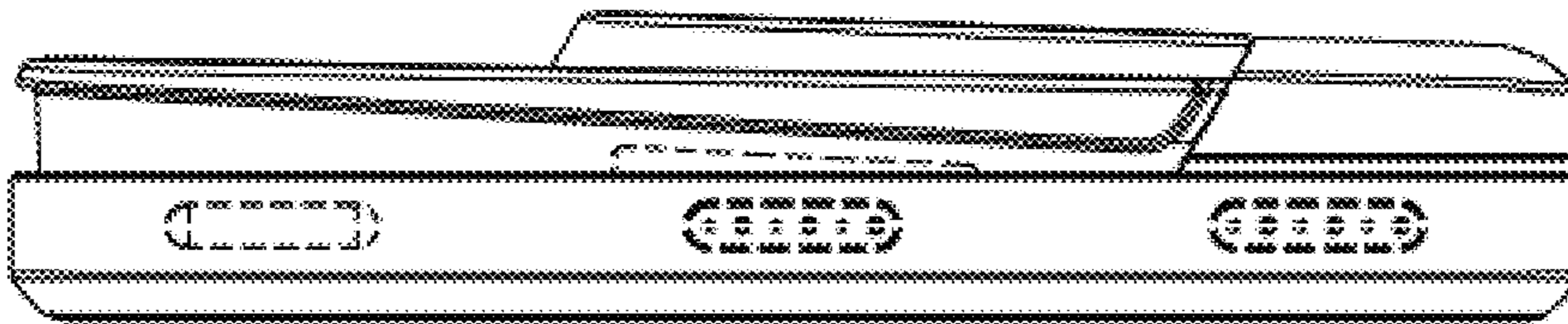

FIG. 6

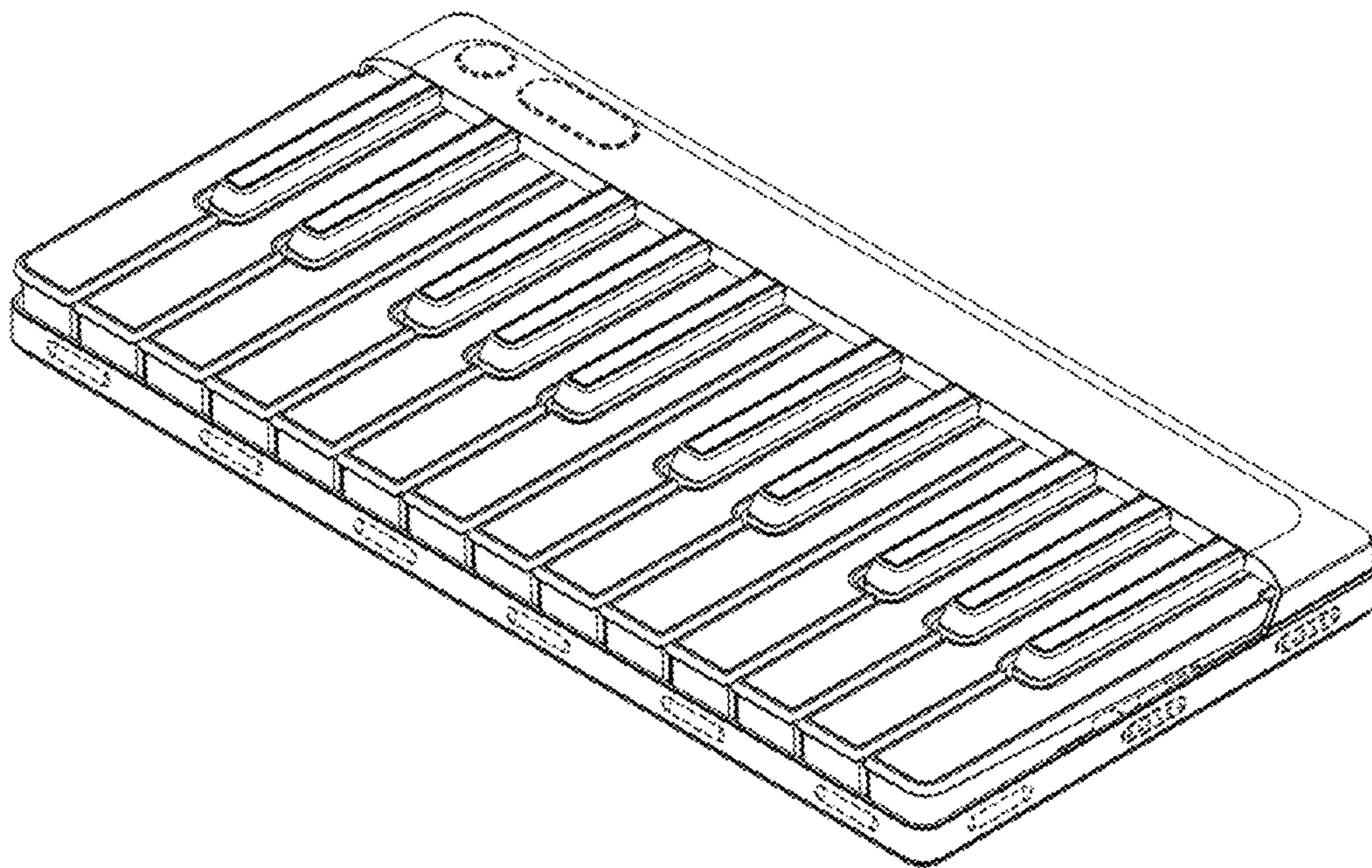

FIG. 7