



US00D935460S

(12) **United States Design Patent**
Zhu

(10) **Patent No.:** **US D935,460 S**

(45) **Date of Patent:** **** Nov. 9, 2021**

(54) **GAME CONTROLLER**

(71) Applicant: **Jiarui Zhu**, Zhongshan (CN)

(72) Inventor: **Jiarui Zhu**, Zhongshan (CN)

(**) Term: **15 Years**

(21) Appl. No.: **29/729,854**

(22) Filed: **Mar. 31, 2020**

(51) **LOC (13) Cl.** **14-03**

(52) **U.S. Cl.**

USPC **D14/401**; D21/333

(58) **Field of Classification Search**

USPC D13/168; D14/218, 388, 389, 414, 401,
D14/413; D21/333, 324, 328, 329

CPC G05G 9/047; G06F 3/02; G06F 3/033;
G09G 5/00; A63F 13/12; A63F 13/24;
A63F 9/00; A63F 11/00

See application file for complete search history.

(56) **References Cited**

U.S. PATENT DOCUMENTS

6,171,191	B1 *	1/2001	Ogata	A63F 13/06 463/38
D712,408	S *	9/2014	Sumii	D14/401
D715,296	S *	10/2014	Huang	D14/401
D780,760	S *	3/2017	Ironmonger	D14/401
D808,968	S *	1/2018	Tang	D14/401
D816,083	S *	4/2018	Wu	D14/401
D878,475	S *	3/2020	Jetter	D21/333
D889,549	S *	7/2020	Ironmonger	D21/333
D894,281	S *	8/2020	Wang	D21/333
2006/0025217	A1 *	2/2006	Hussaini	A63F 13/22 463/36

2015/0238855	A1 *	8/2015	Uy	G06F 3/0362 463/37
2017/0151494	A1 *	6/2017	Ironmonger	A63F 13/22
2020/0222799	A1 *	7/2020	Chang	A63F 13/24
2020/0406131	A1 *	12/2020	Benson	A63F 13/24

OTHER PUBLICATIONS

PS4 Controller Kit; Oct. 19, 2020, 3 pgs. advertised on Amazon; https://www.amazon.com/eXtremeRate-Tournament-Controller-Upgrade-Ergonomic/dp/B08LH7FDYJ/ref=sr_1_1?dchild=1&keywords=tournament-controller-dtc-upgrade-kit-for-ps4-controller-jdm-040-050-055-upgrade-board-ergonomic-shell-back-buttons-trigger-stops-.*

* cited by examiner

Primary Examiner — Selina Sikder

(57) **CLAIM**

The ornamental design for game controller, as shown and described.

DESCRIPTION

FIG. 1 is a front perspective view of a game controller showing my new design;
FIG. 2 is a rear perspective view thereof;
FIG. 3 is a front elevational view thereof;
FIG. 4 is a rear elevational view thereof;
FIG. 5 is a left side elevational view thereof;
FIG. 6 is a right side elevational view thereof;
FIG. 7 is a top plan view thereof; and,
FIG. 8 is a bottom plan view thereof.
In the drawings, the broken lines depict a portion of the game controller which form no part of the claimed design.

1 Claim, 8 Drawing Sheets

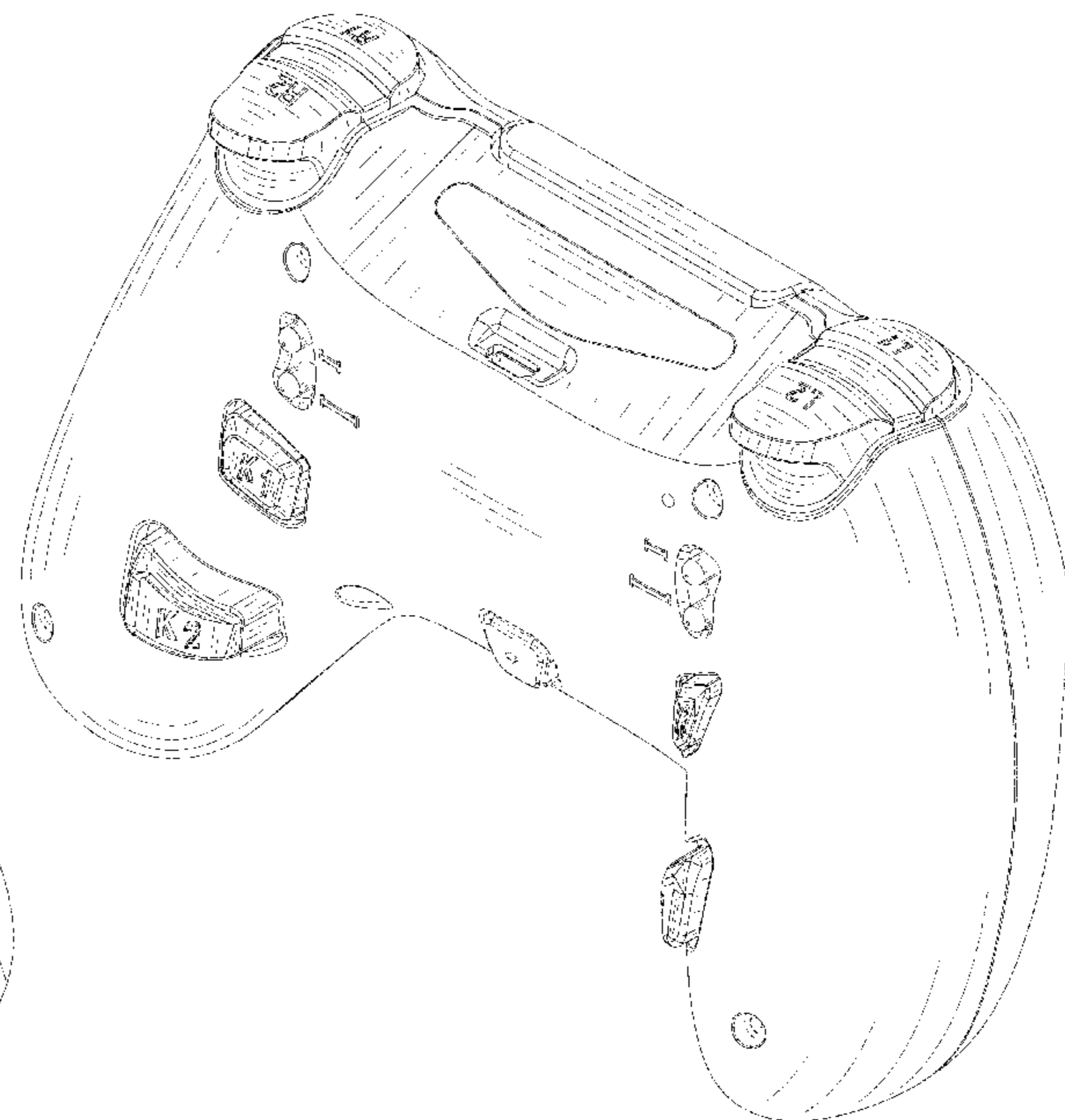
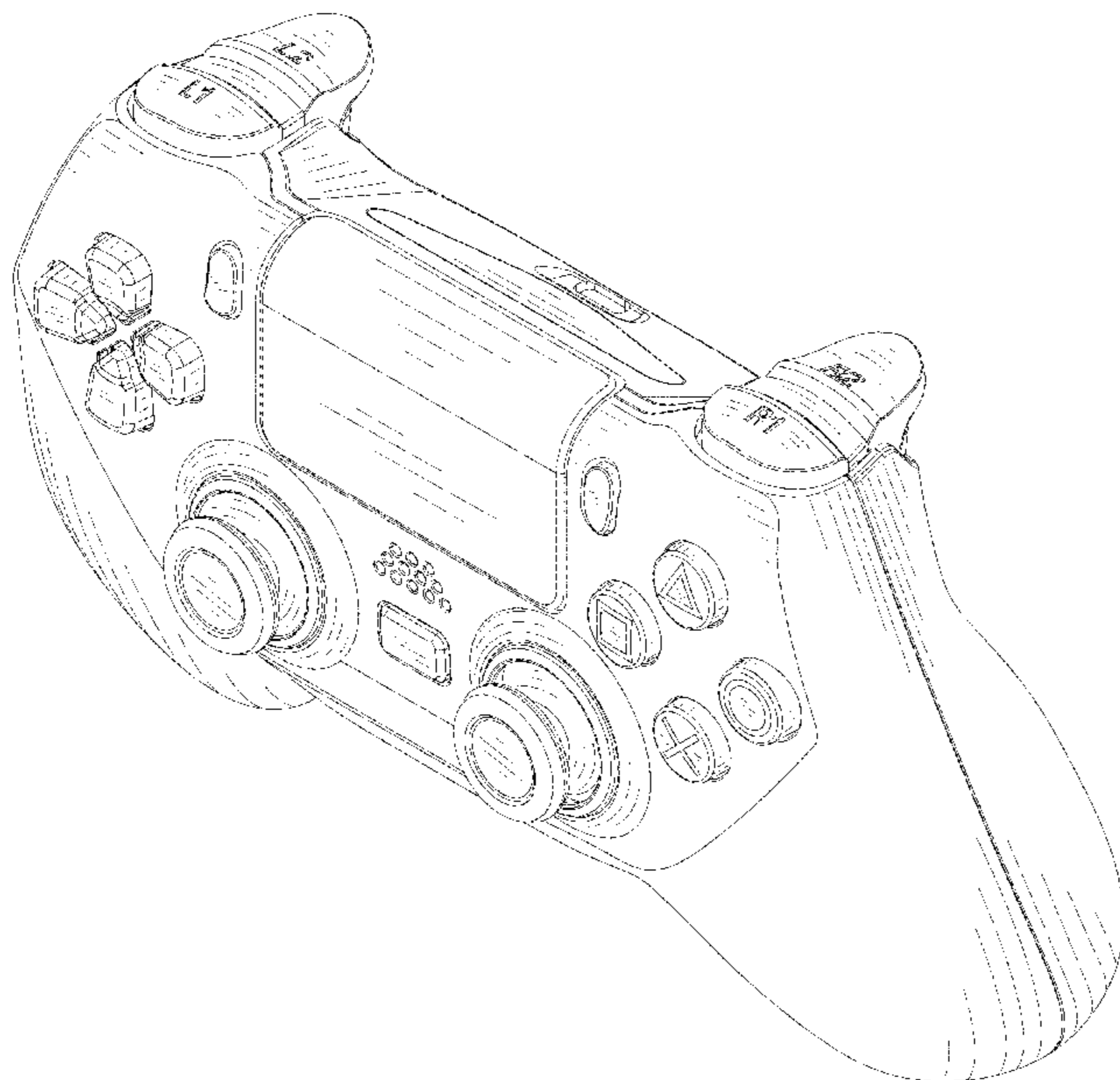

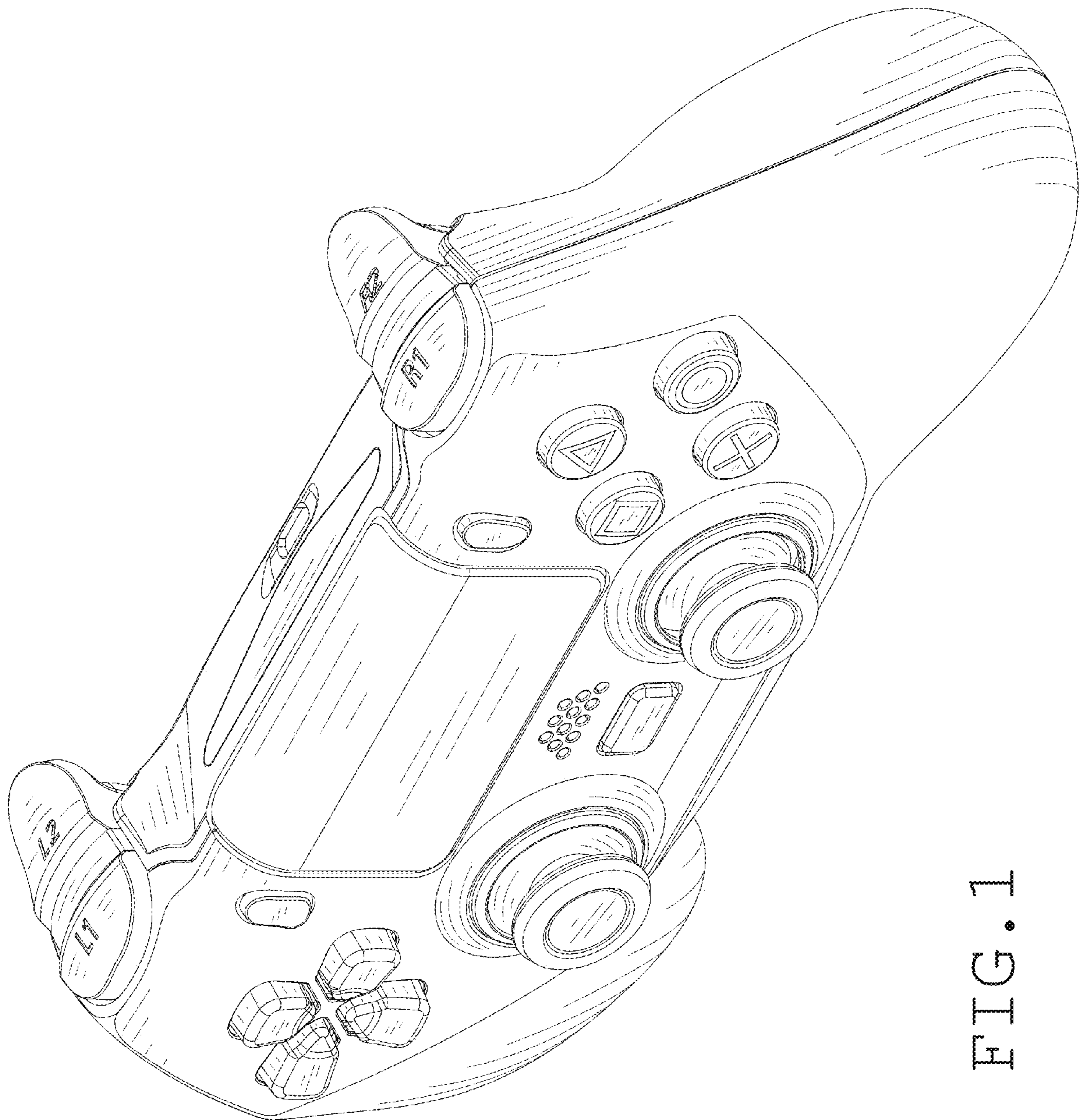

FIG. 1

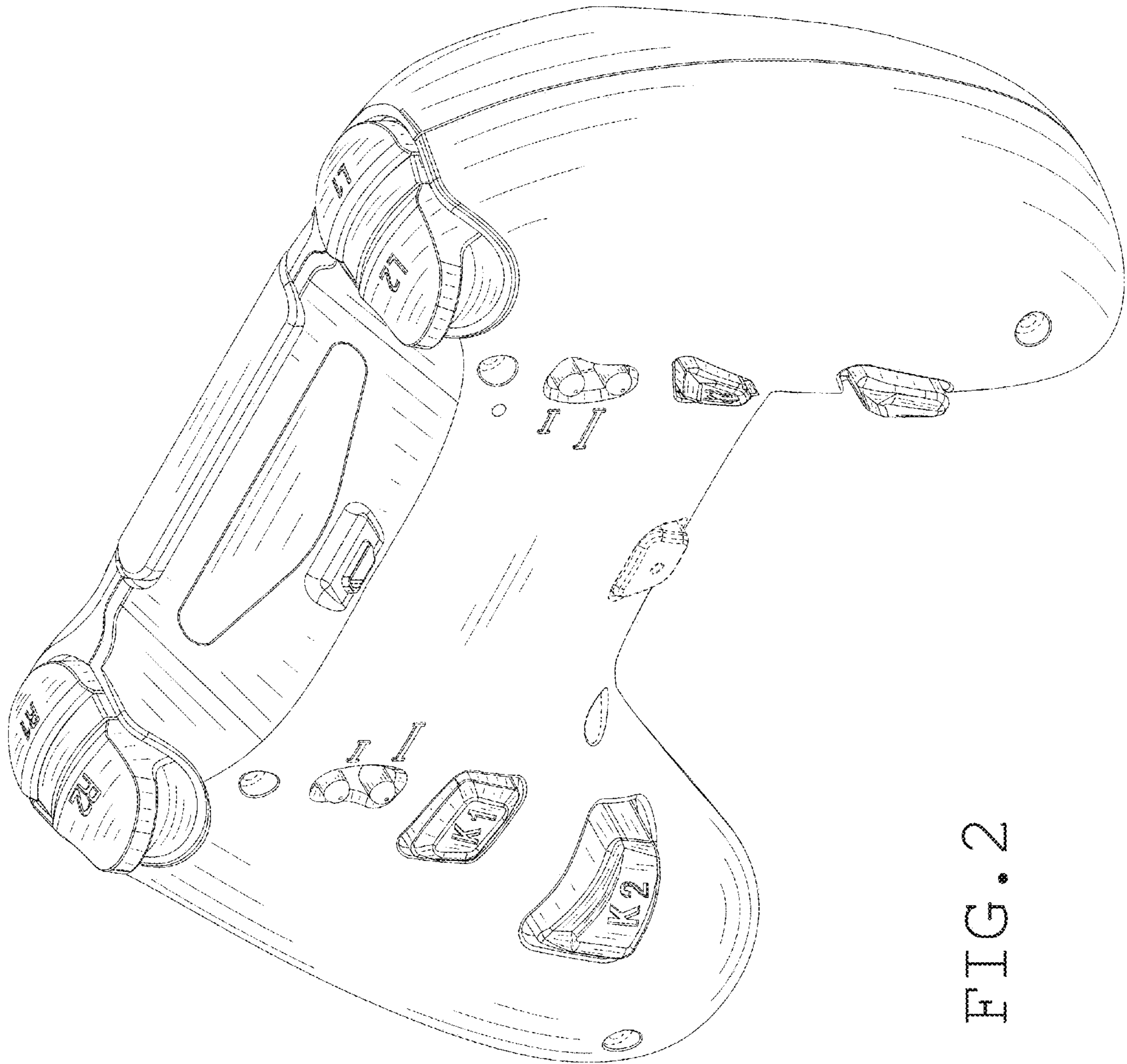

FIG. 2

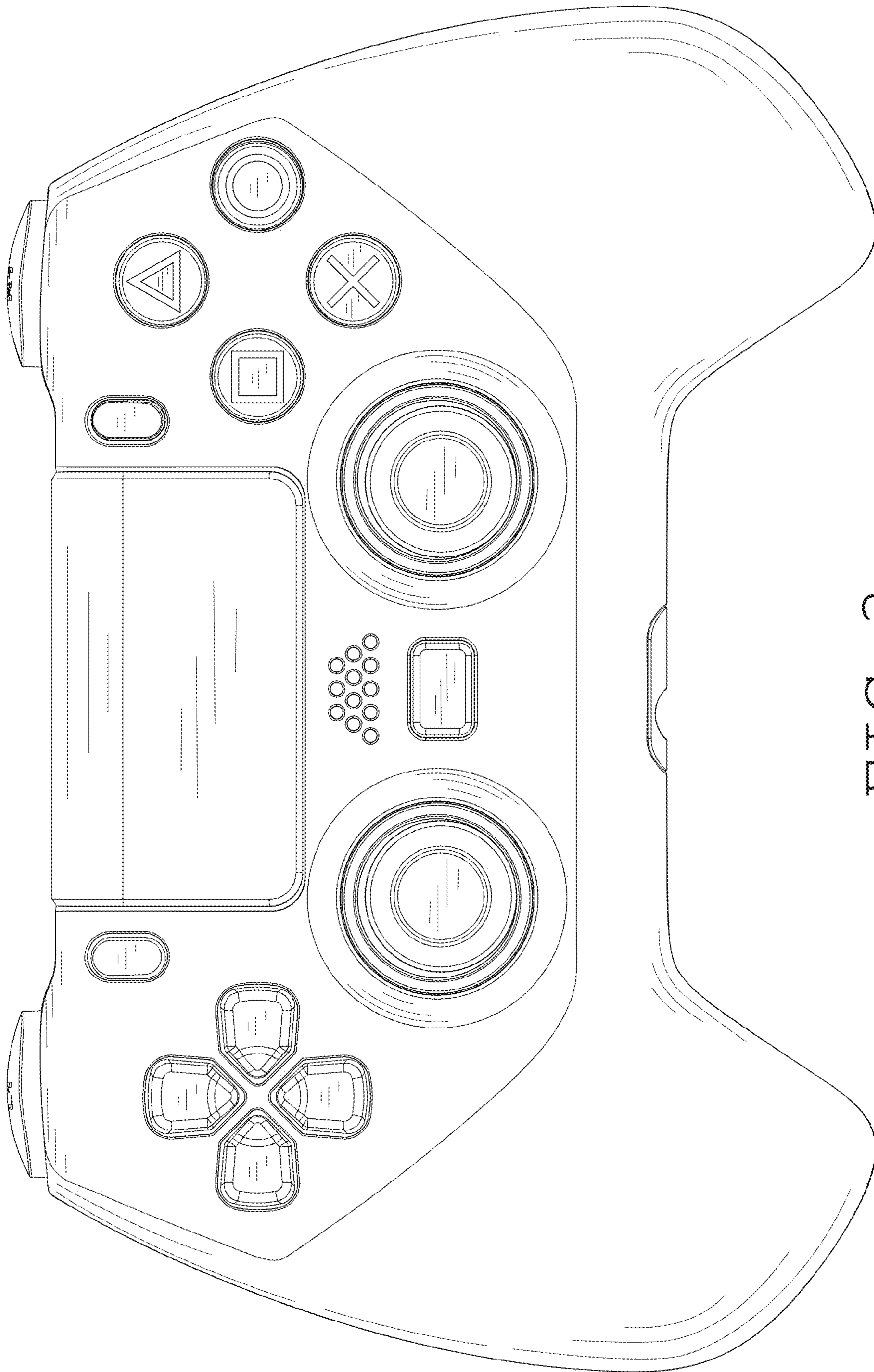

FIG. 3

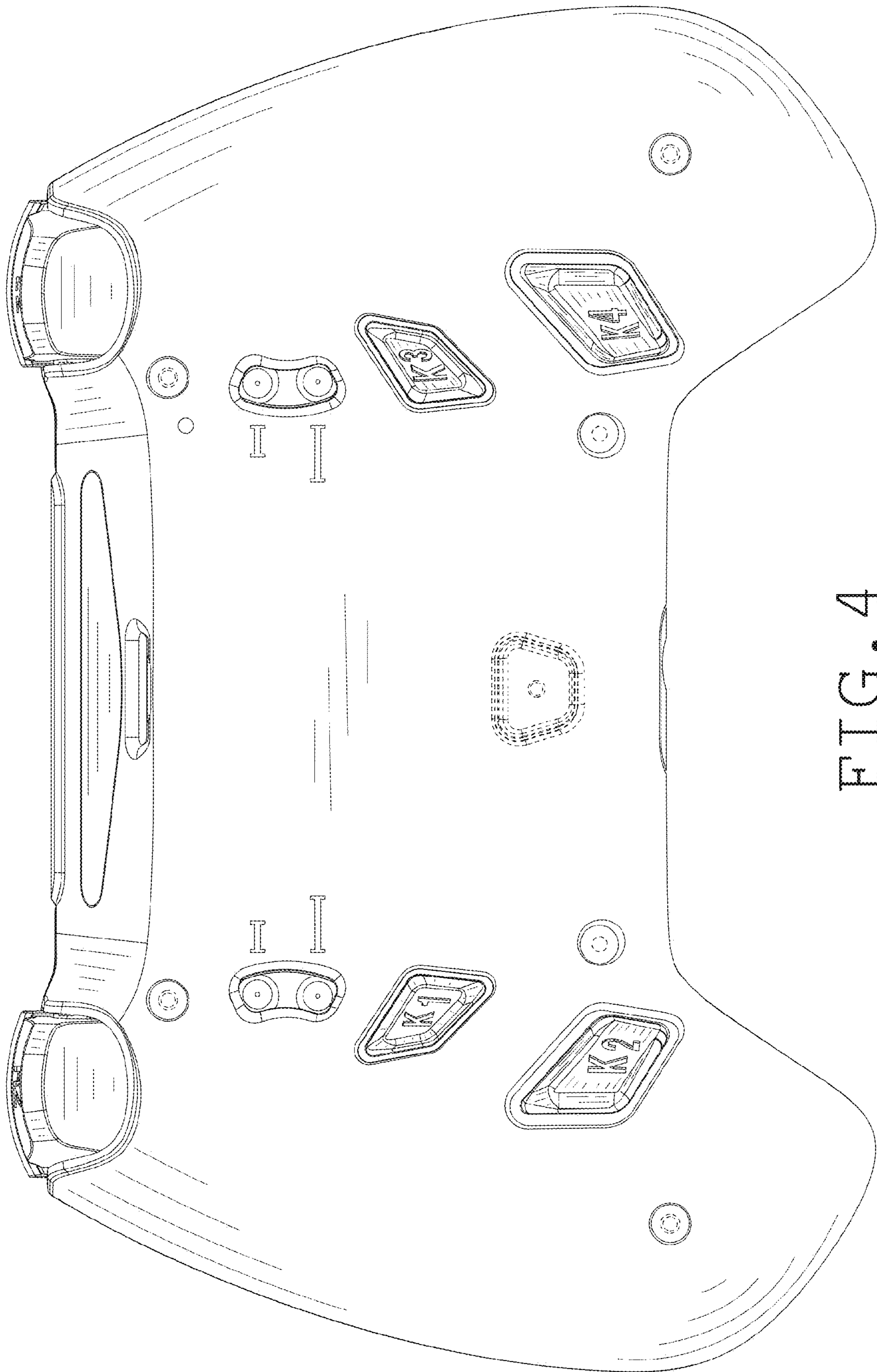

FIG. 4

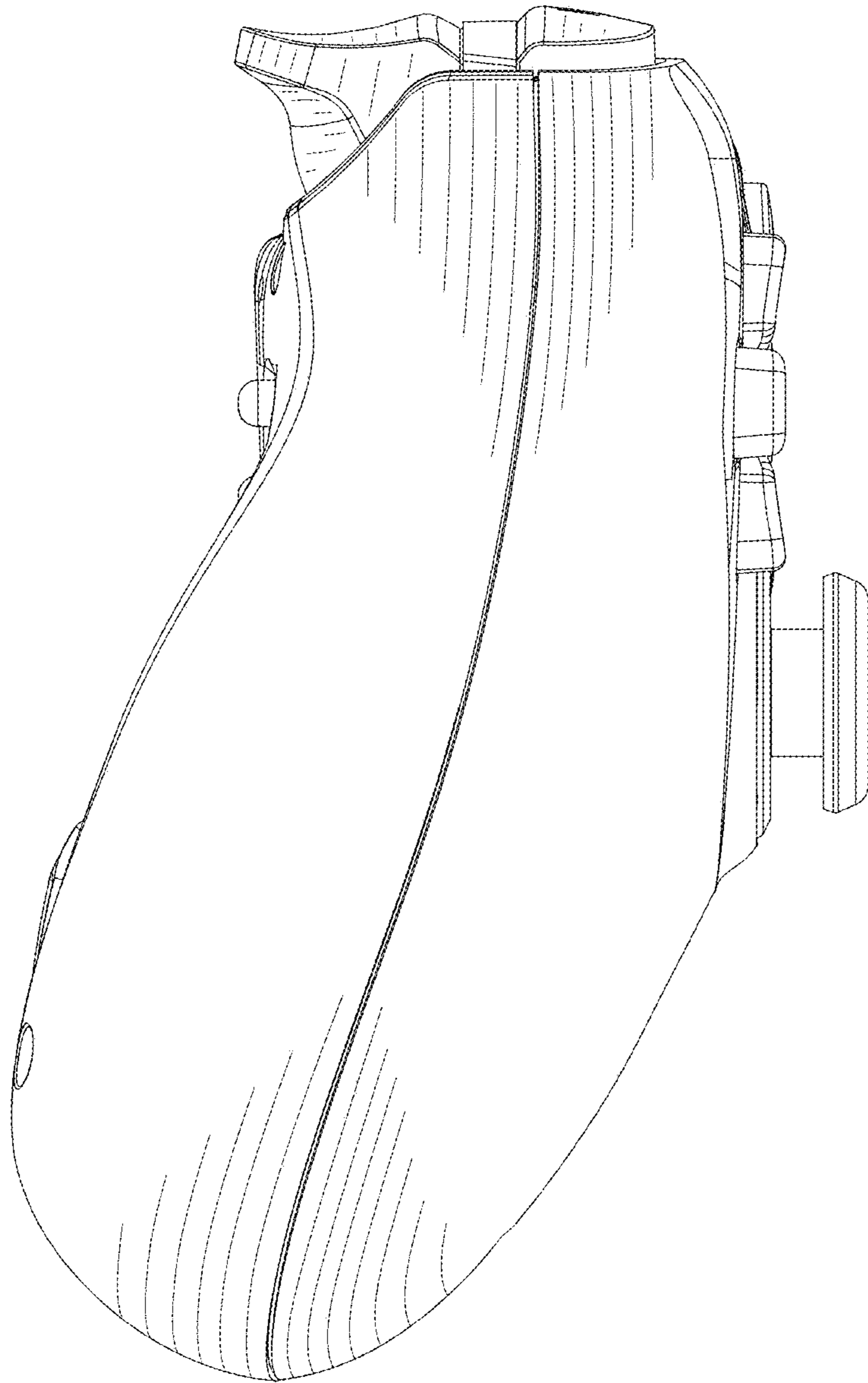

FIG. 5

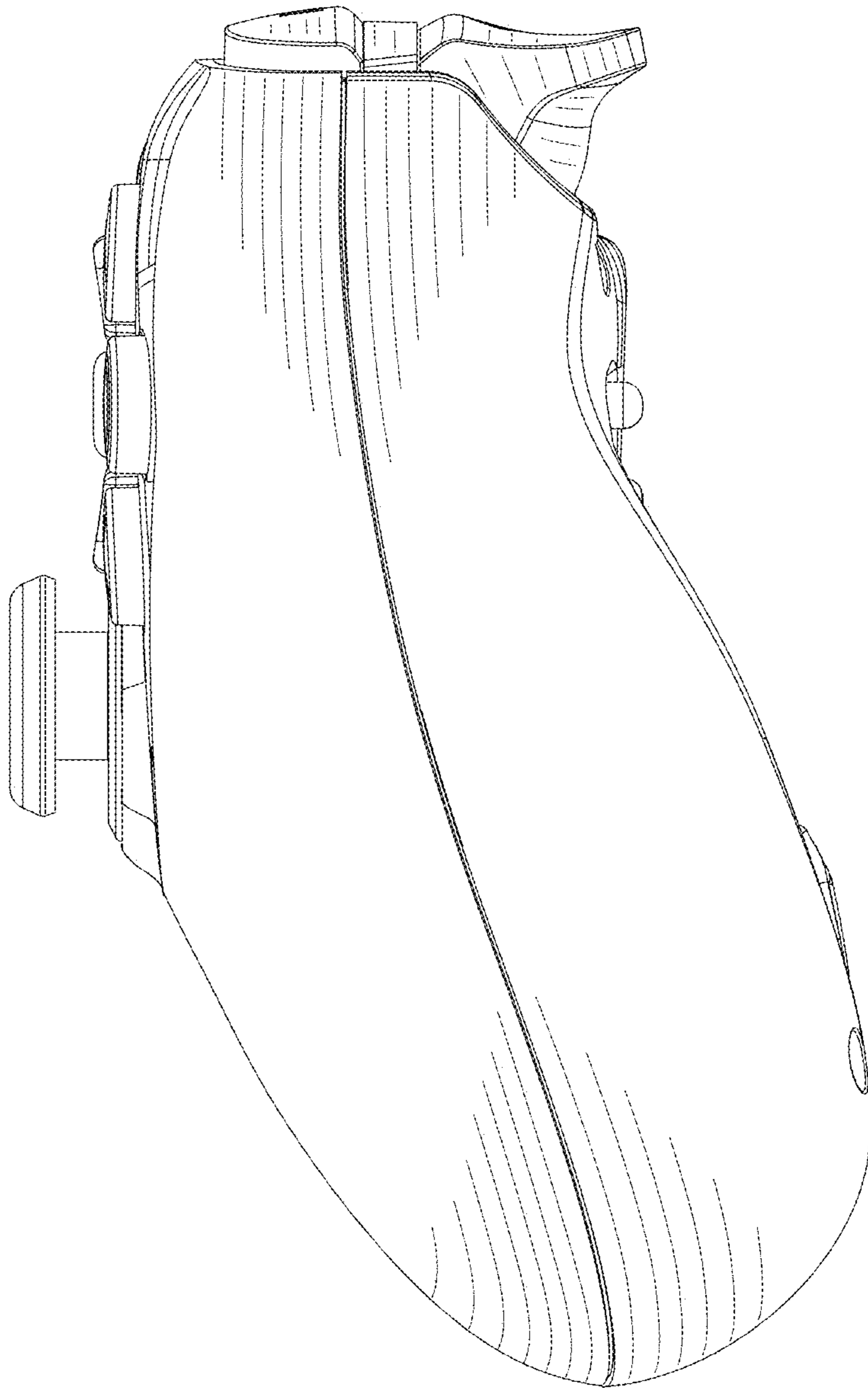

FIG. 6

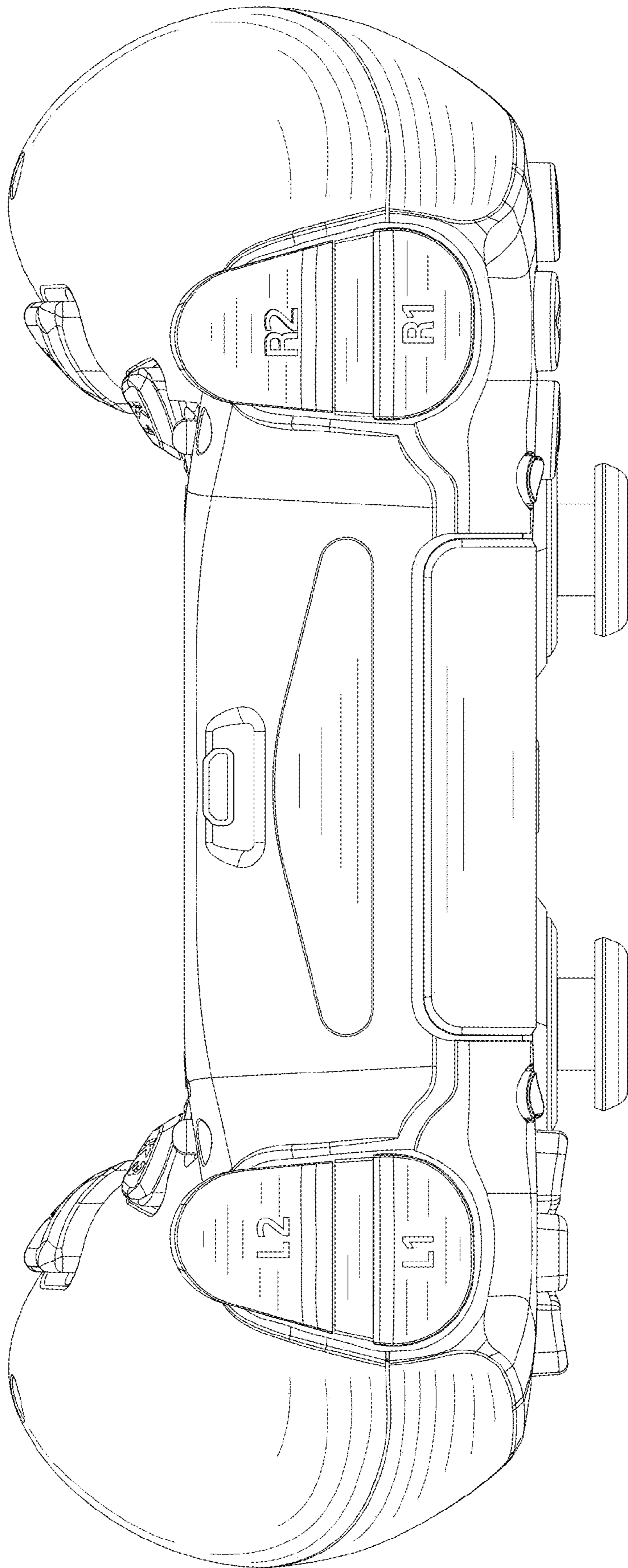

FIG. 7

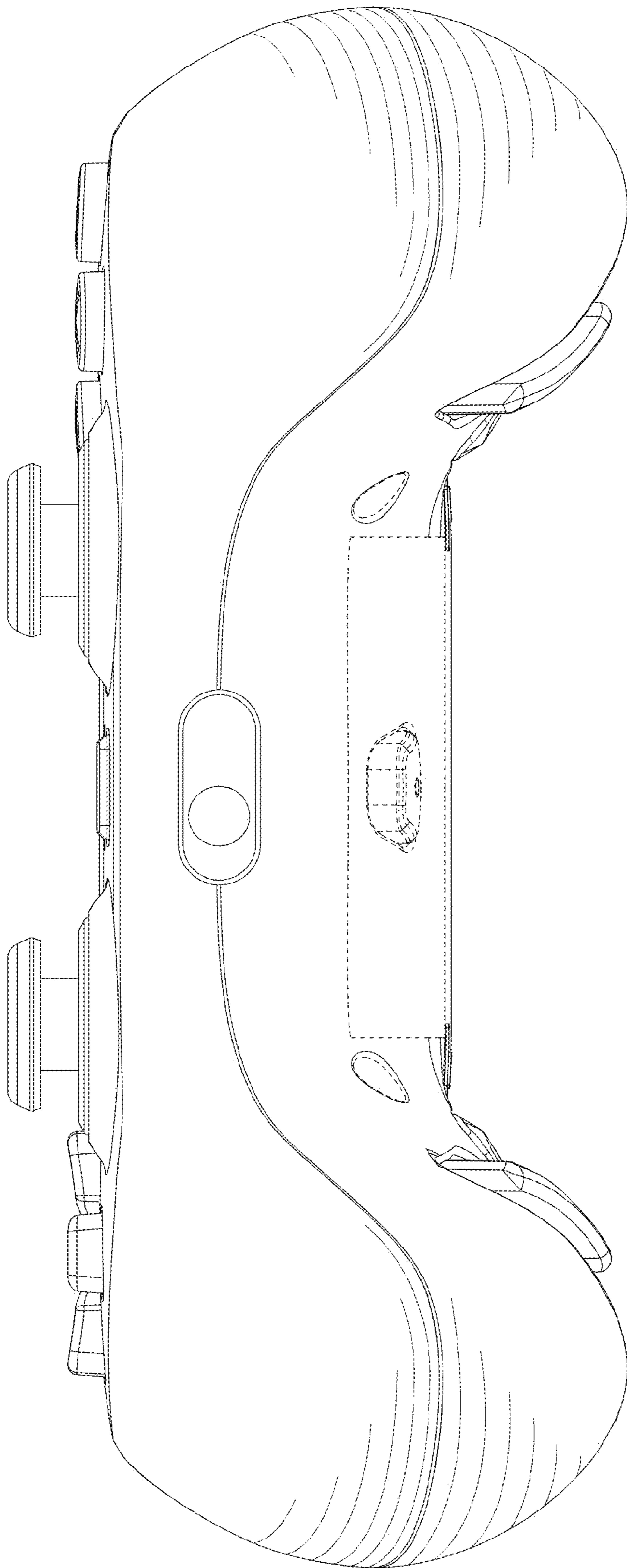

FIG. 8