



US00D935141S

(12) **United States Design Patent**  
**Louboutin**

(10) **Patent No.:** **US D935,141 S**

(45) **Date of Patent:** **\*\* Nov. 9, 2021**

(54) **FOOTWEAR**

(71) Applicant: **Christian Louboutin**, Paris (FR)

(72) Inventor: **Christian Louboutin**, Paris (FR)

(73) Assignee: **PALOÏSE SAS**, Paris (FR)

(\*\*) Term: **15 Years**

(21) Appl. No.: **29/717,208**

(22) Filed: **Dec. 16, 2019**

(30) **Foreign Application Priority Data**

Jun. 18, 2019 (EM) ..... 006584934

(51) **LOC (13) Cl.** ..... **02-04**

(52) **U.S. Cl.**  
USPC ..... **D2/907; D2/947**

(58) **Field of Classification Search**  
USPC ..... D2/896, 902, 906-908, 969, 972  
CPC ... A43B 13/181; A43B 13/141; A43B 13/186;  
A43B 13/188; A43B 1/04; A43B 23/00  
See application file for complete search history.

(56) **References Cited**

**U.S. PATENT DOCUMENTS**

D266,881 S *	11/1982	Ueno	.....	D2/908
D568,587 S *	5/2008	Dolce	.....	D2/902
D571,095 S *	6/2008	Clifford	.....	D2/946
D590,138 S *	4/2009	Cofinco	.....	D2/902
D656,717 S *	4/2012	Abramowitz	.....	D2/946
D694,505 S *	12/2013	Brozina	.....	D2/972
D875,355 S *	2/2020	Fang	.....	D2/896

**OTHER PUBLICATIONS**

Christian Louboutin posted by Florence Consul posted date Apr. 27, 2018, © Forbes, [online], [site visited May 7, 2021]. Available from

Internet, <https://www.forbes.fr/luxe/christian-louboutin-le-symbole-de-la-semelle-rouge/> (Year: 2018).\*

Sparkle Lite Unicorn Sneaker posted by Sketchers posted date Jun. 6, 2018, © Amazon, [online], [site visited May 7, 2021]. Available from Internet, [https://www.amazon.com/dp/B07CZZVFHG/ref=twister\\_B07CZW8ML3](https://www.amazon.com/dp/B07CZZVFHG/ref=twister_B07CZW8ML3) (Year: 2018).\*

\* cited by examiner

*Primary Examiner* — T Chase Nelson

*Assistant Examiner* — Laura H Yu

(74) *Attorney, Agent, or Firm* — Fross Zelnick Lehrman & Zissu, P.C.; Charles T. J. Weigell, Esq.

(57) **CLAIM**

The ornamental design for footwear, as shown and described.

**DESCRIPTION**

FIG. 1 is a front perspective view of footwear showing my new design;

FIG. 2 is a front view thereof;

FIG. 3 is a back view thereof;

FIG. 4 is a left side view thereof;

FIG. 5 is a right side view thereof;

FIG. 6 is a top view thereof;

FIG. 7 is a bottom view thereof;

FIG. 8 is a front perspective view of the footwear, showing my new design in an alternative embodiment;

FIG. 9 is a front view thereof;

FIG. 10 is a back view thereof;

FIG. 11 is a left side view thereof;

FIG. 12 is a right side view thereof;

FIG. 13 is a top view thereof; and,

FIG. 14 is a bottom view thereof.

The broken lines in the drawings illustrate stitching and form no part of the claimed design.

The cross-hatching in the drawings shows a textured cross-hatched surface.

**1 Claim, 12 Drawing Sheets**

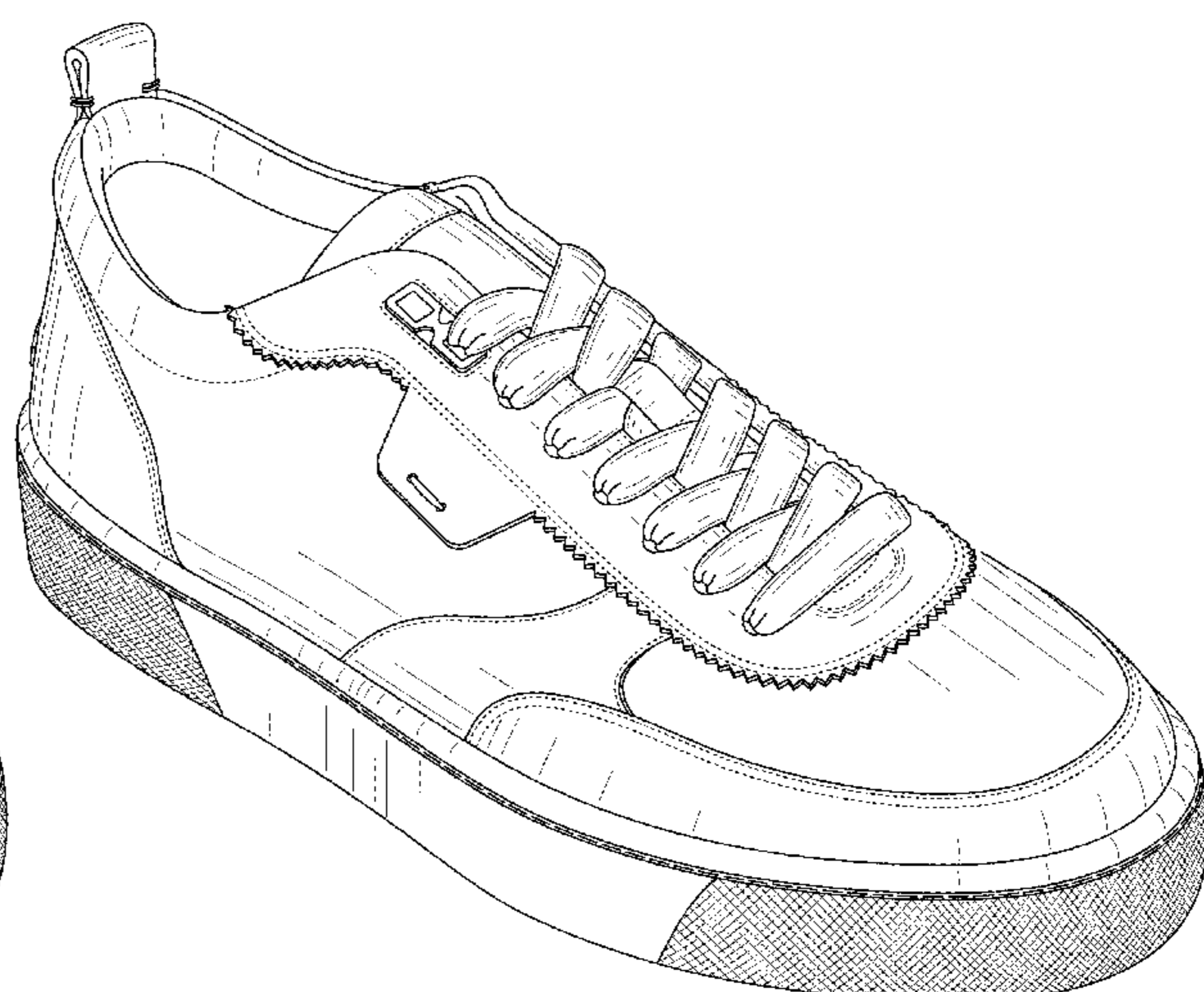



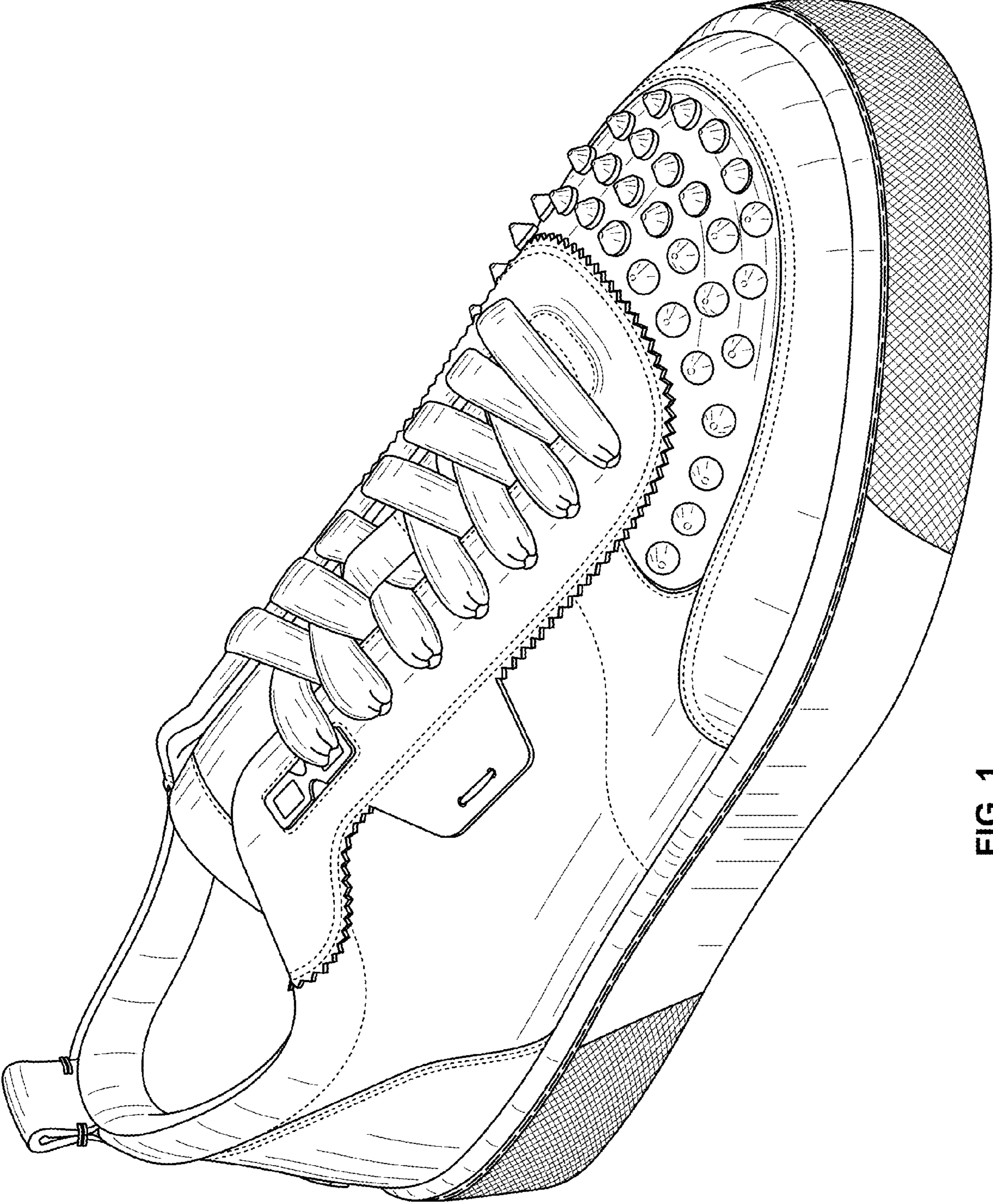

FIG. 1



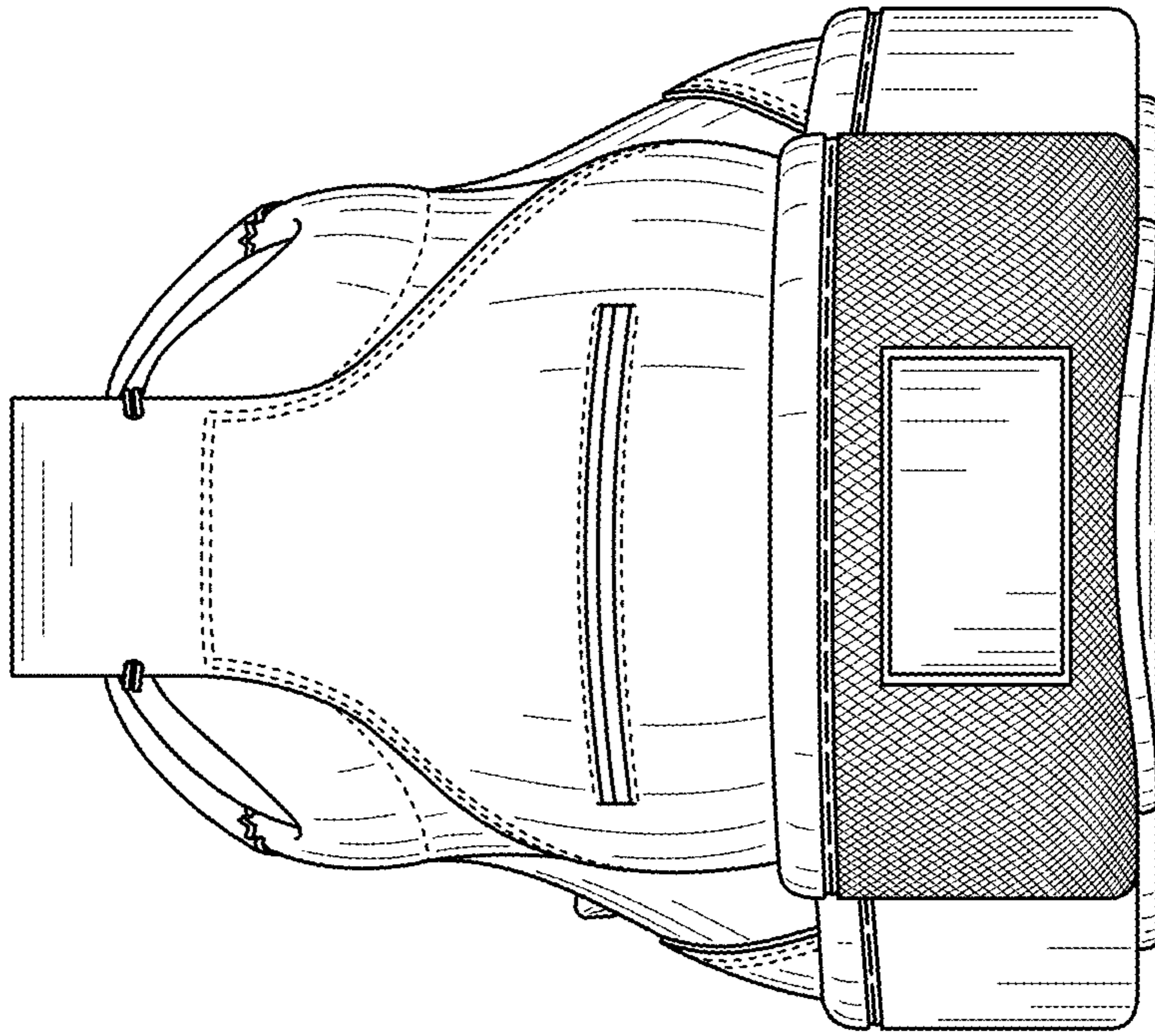

FIG. 3

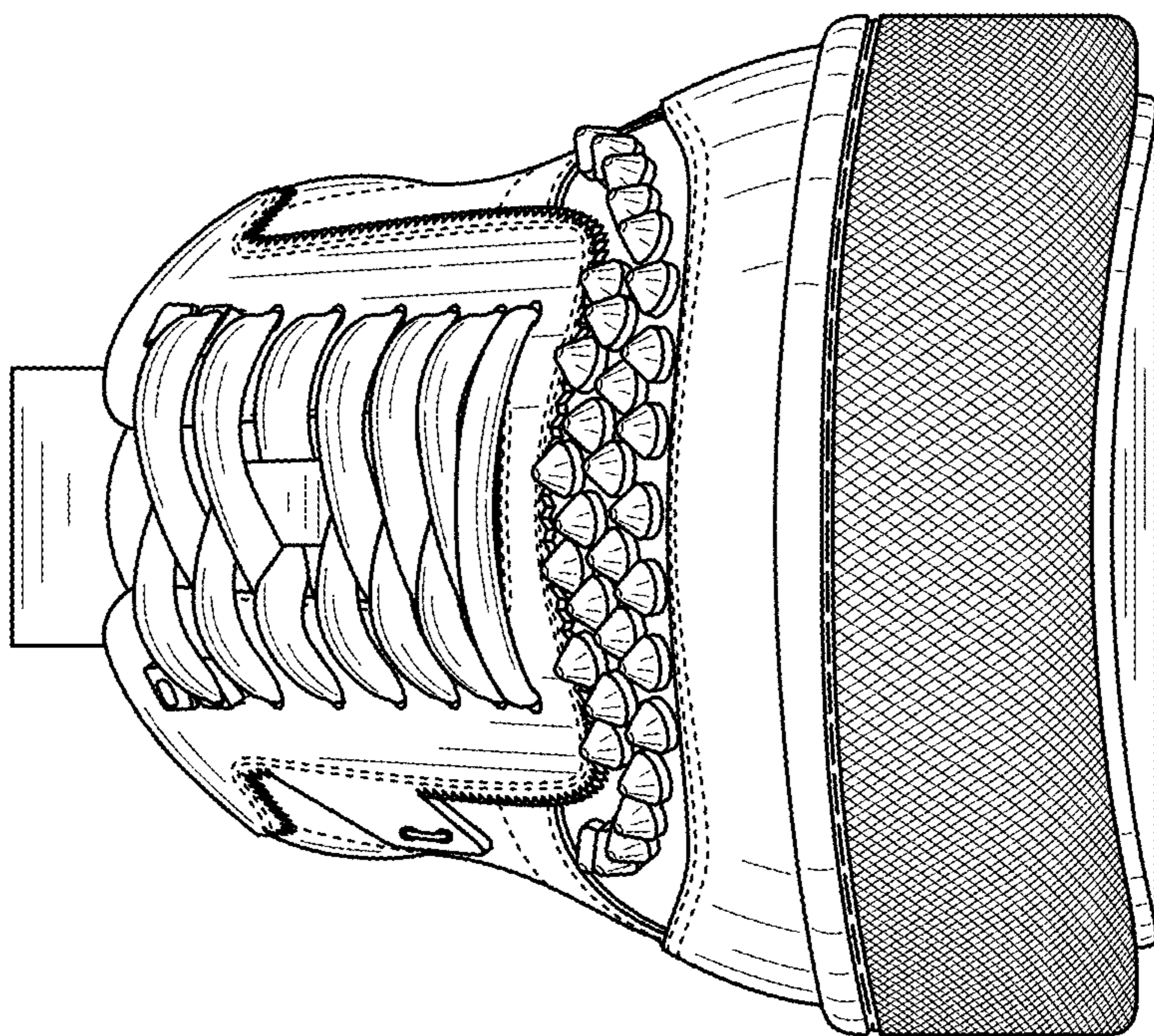

FIG. 2



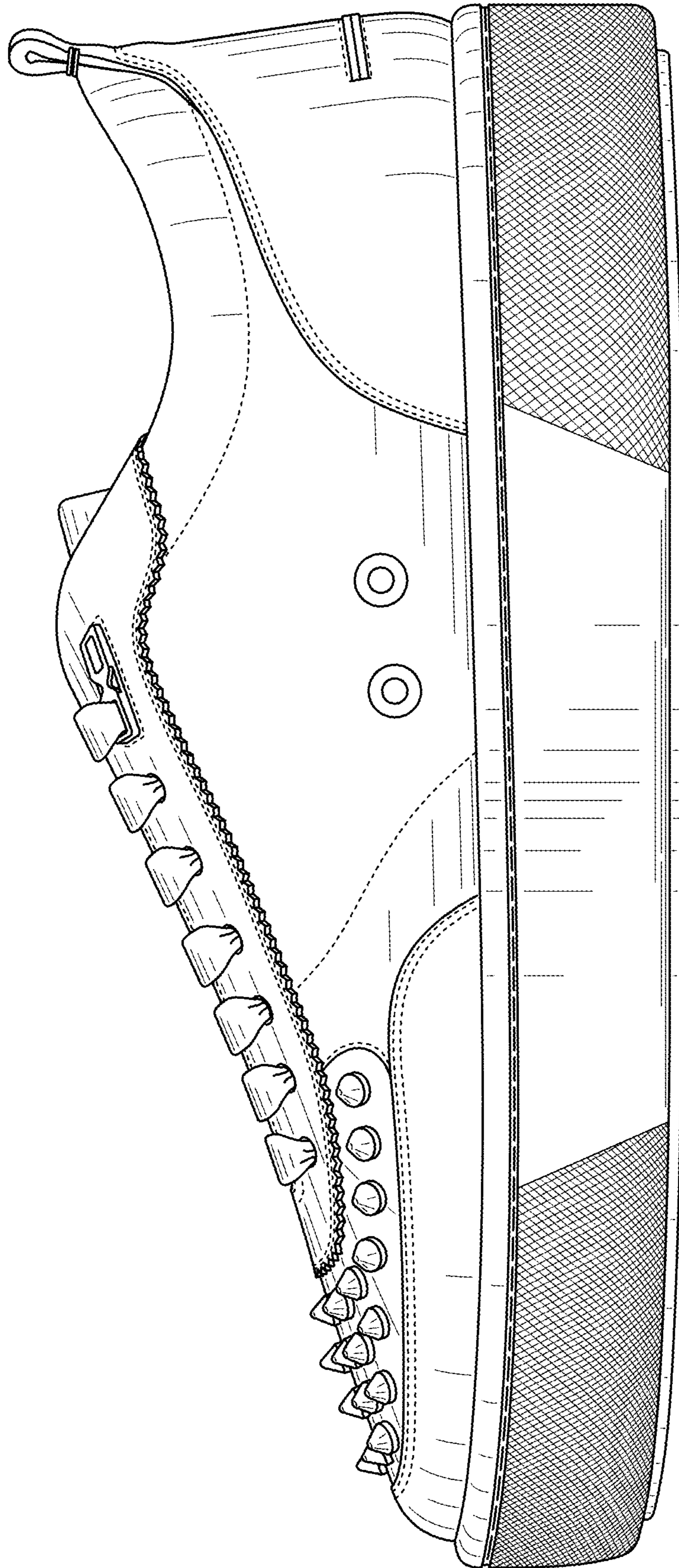

FIG. 4

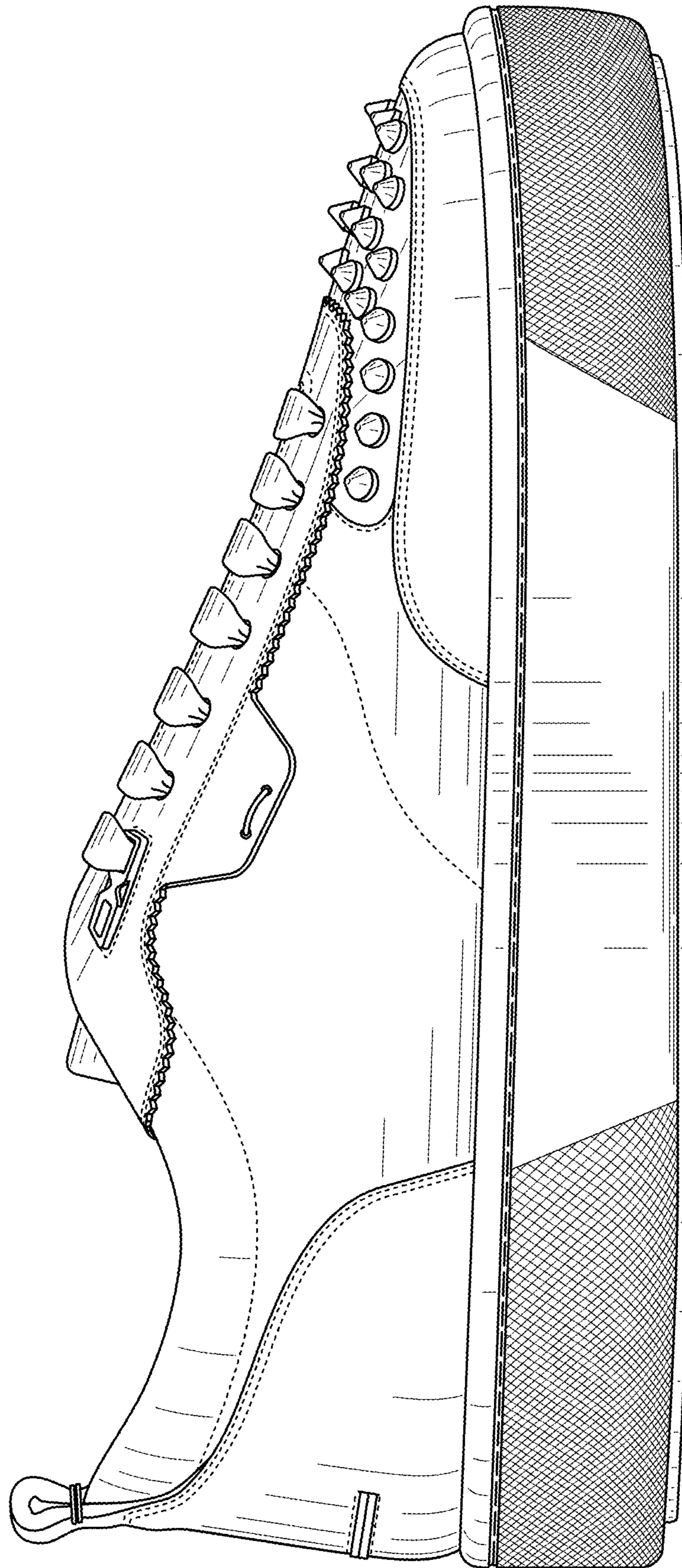

FIG. 5



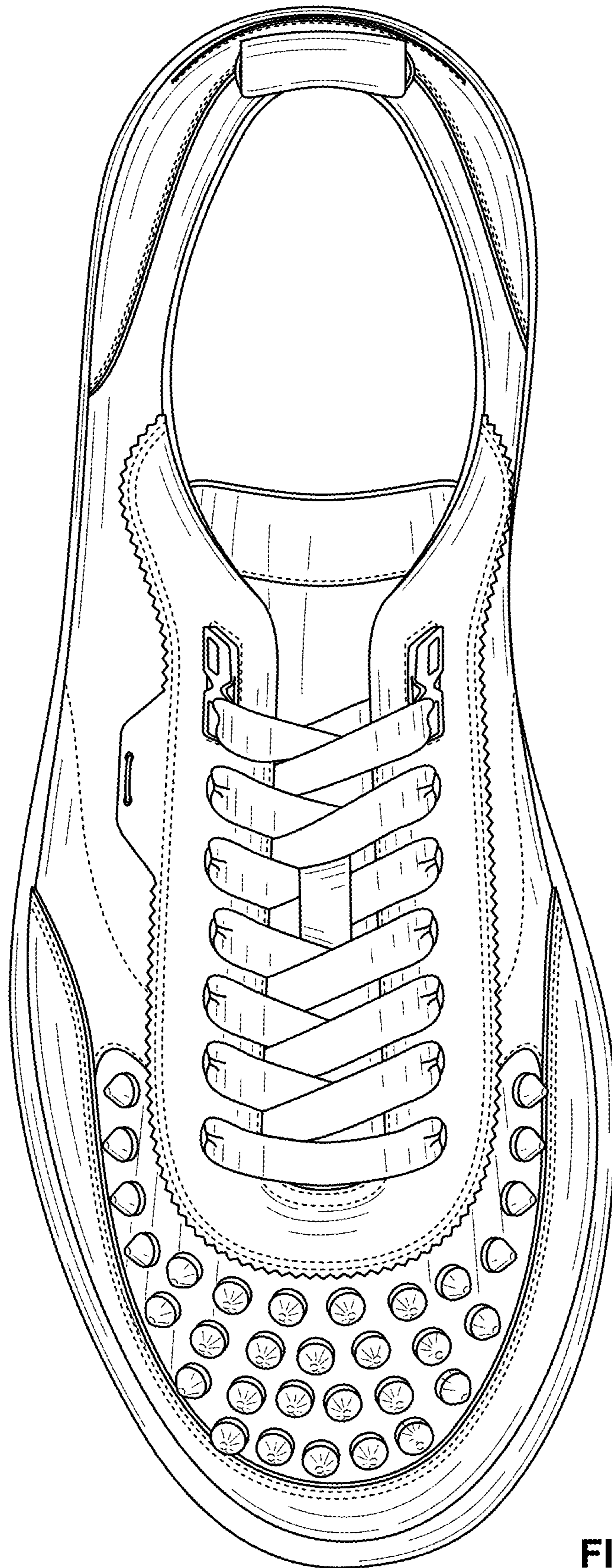

FIG. 6

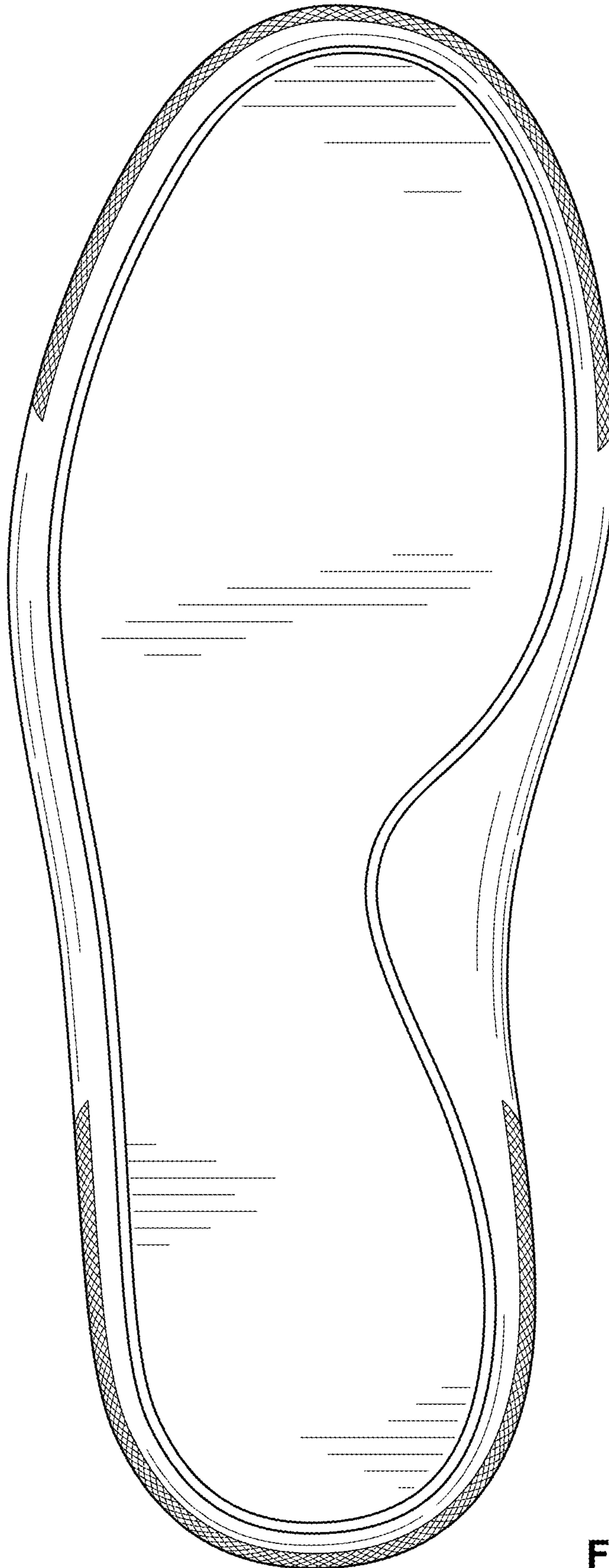

FIG. 7



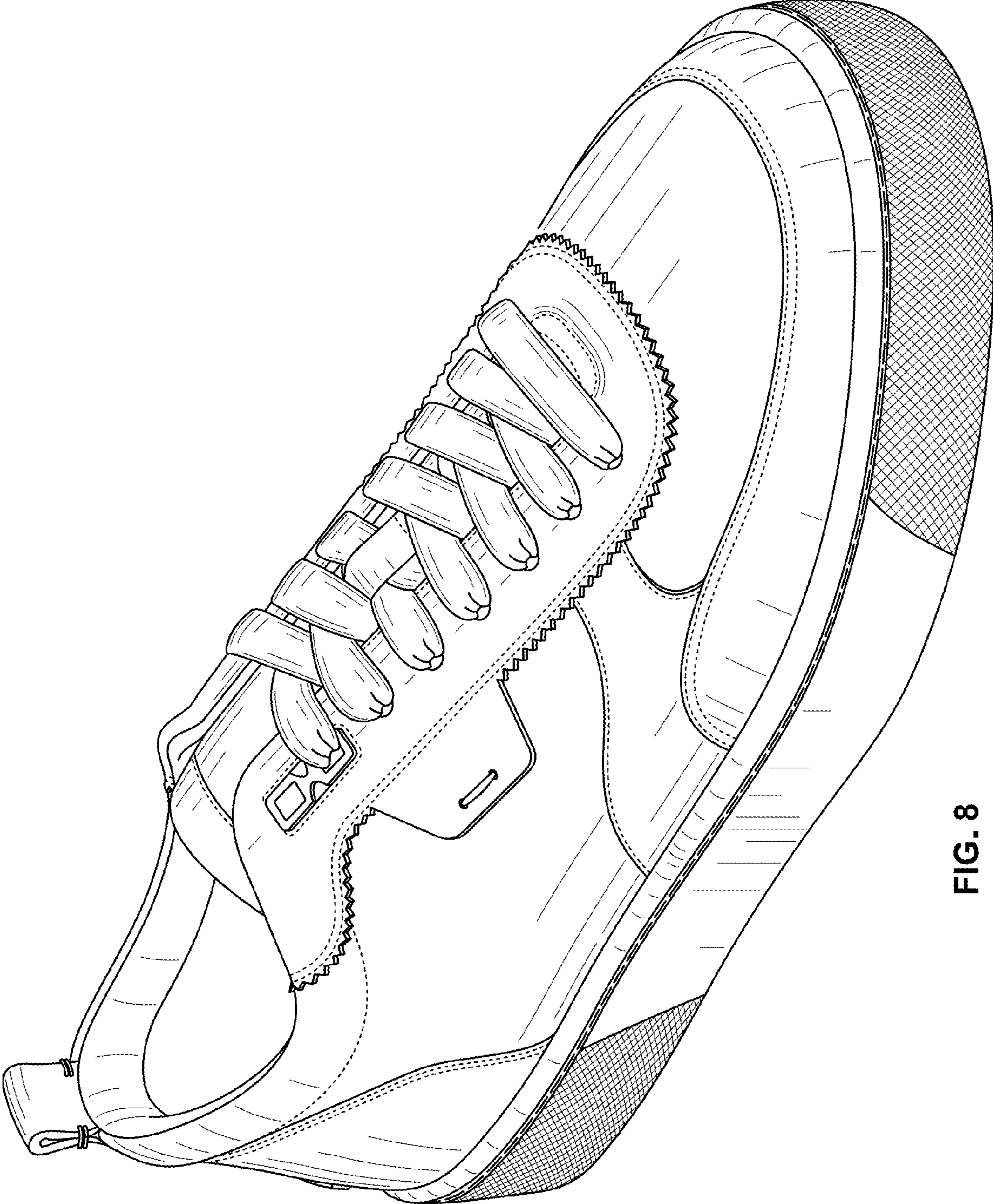

FIG. 8



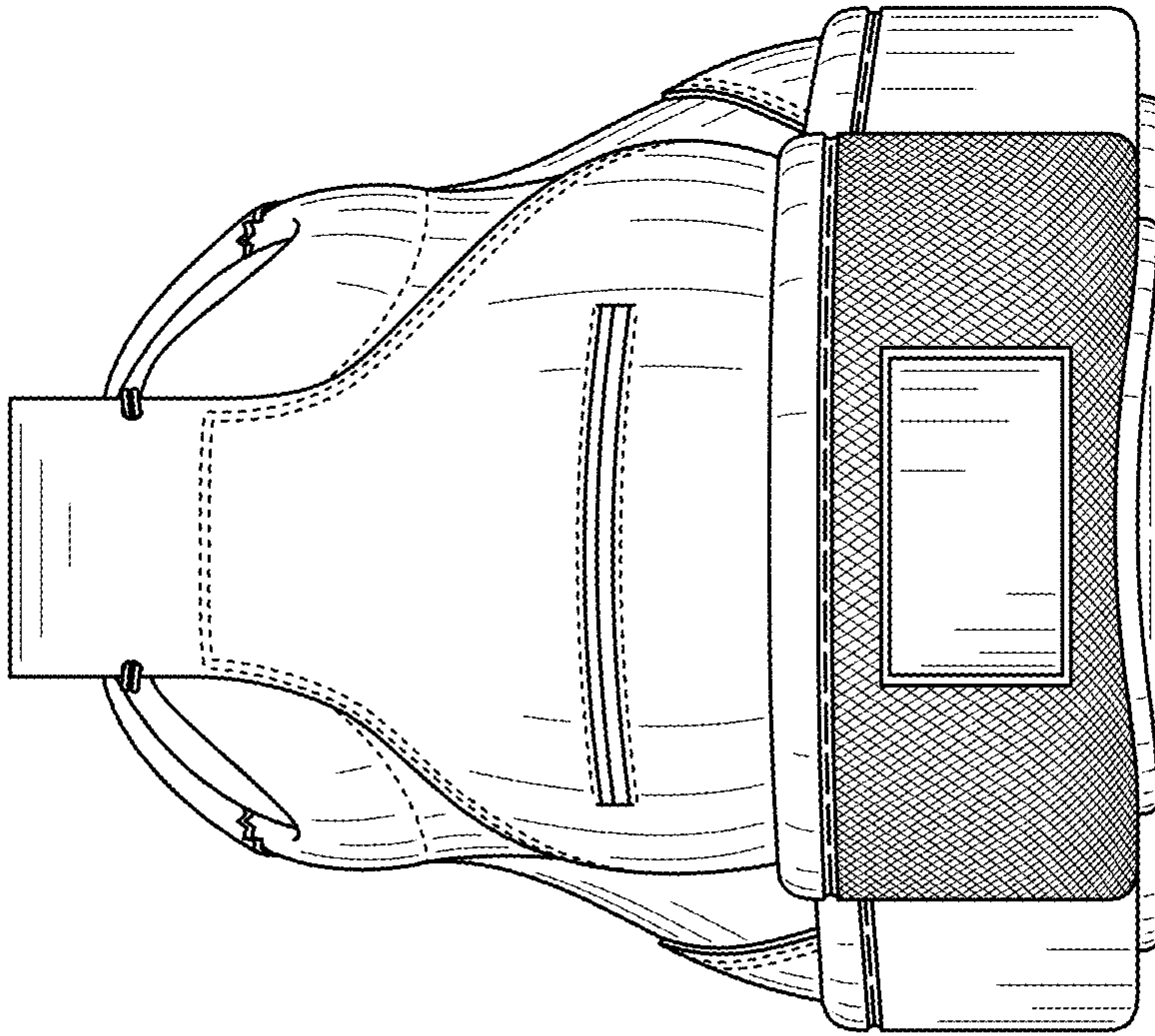

FIG. 9

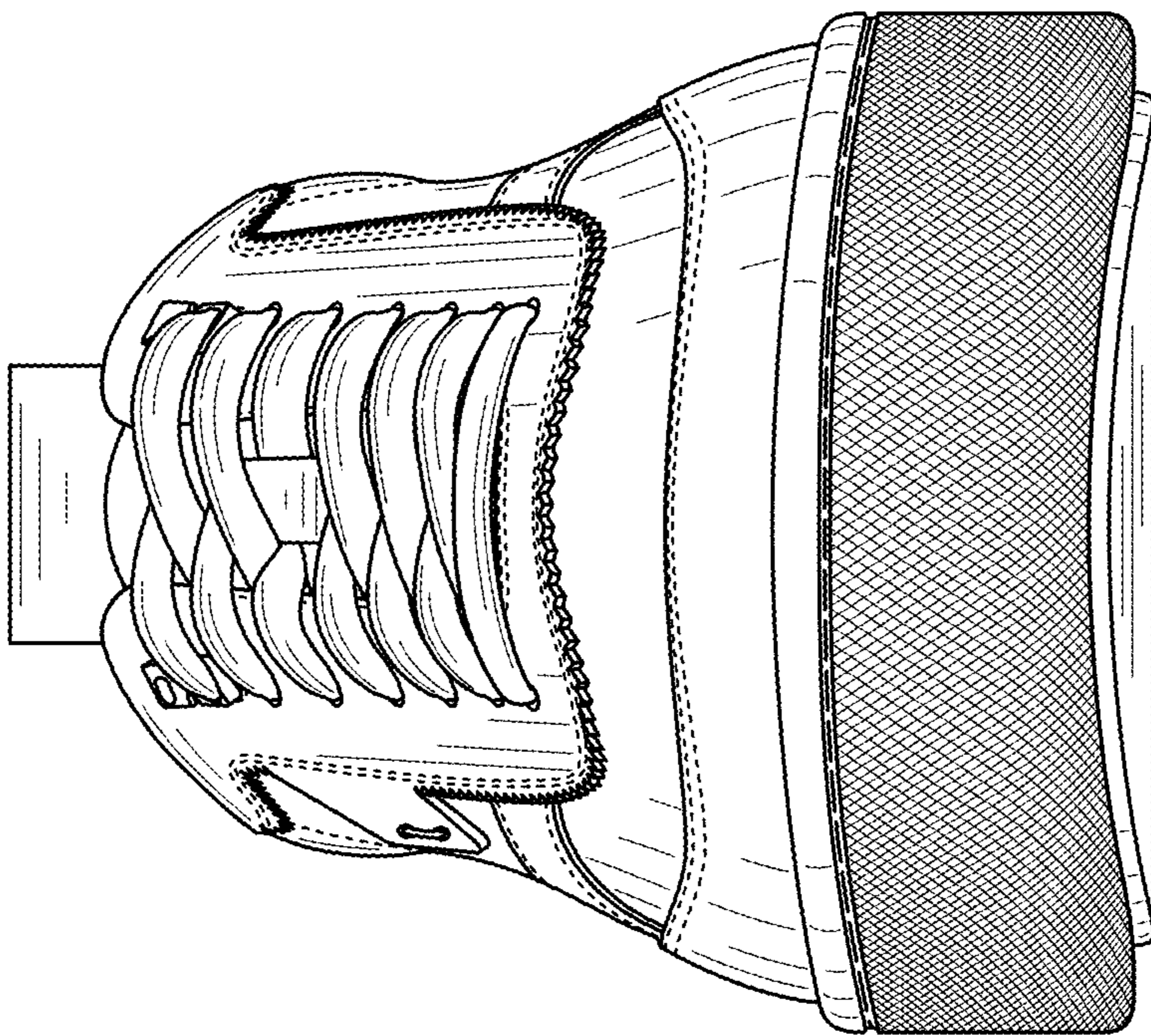

FIG. 10



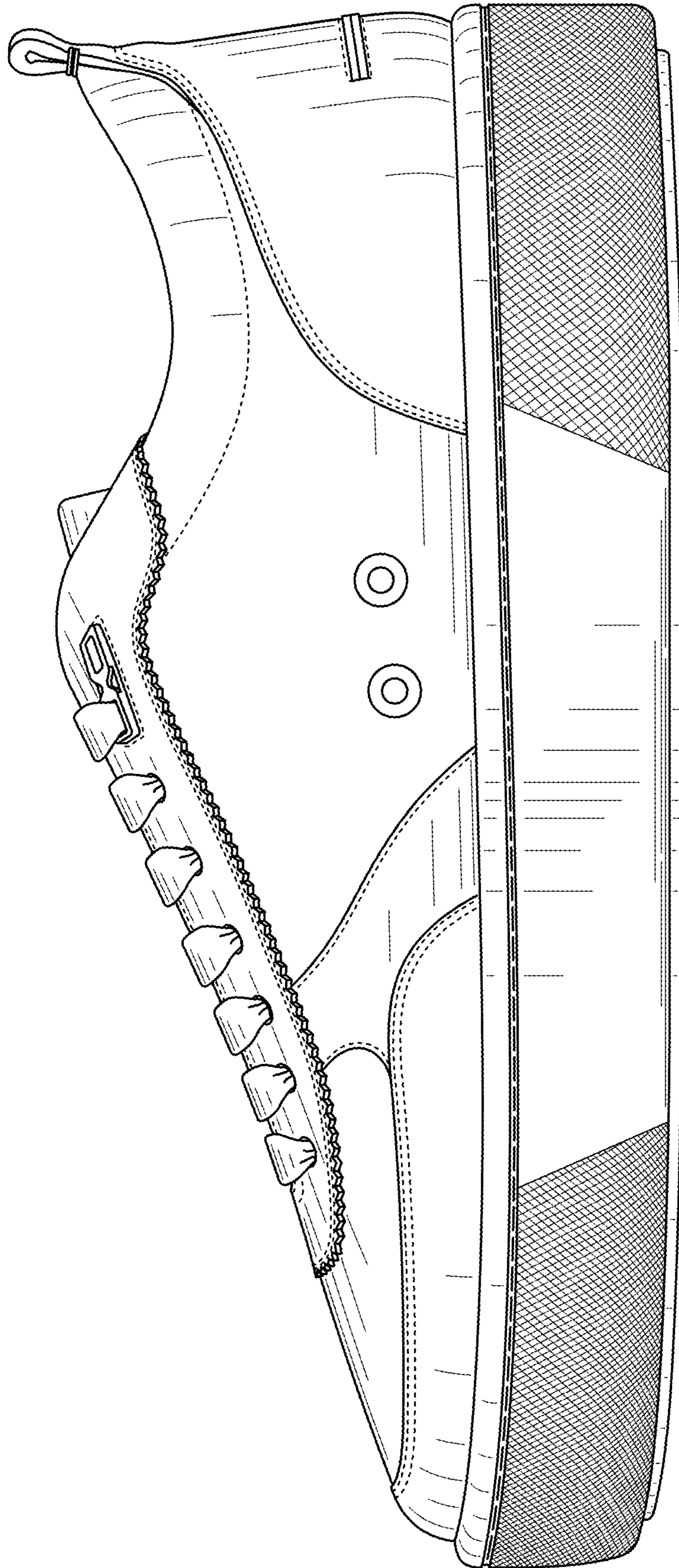

FIG. 11



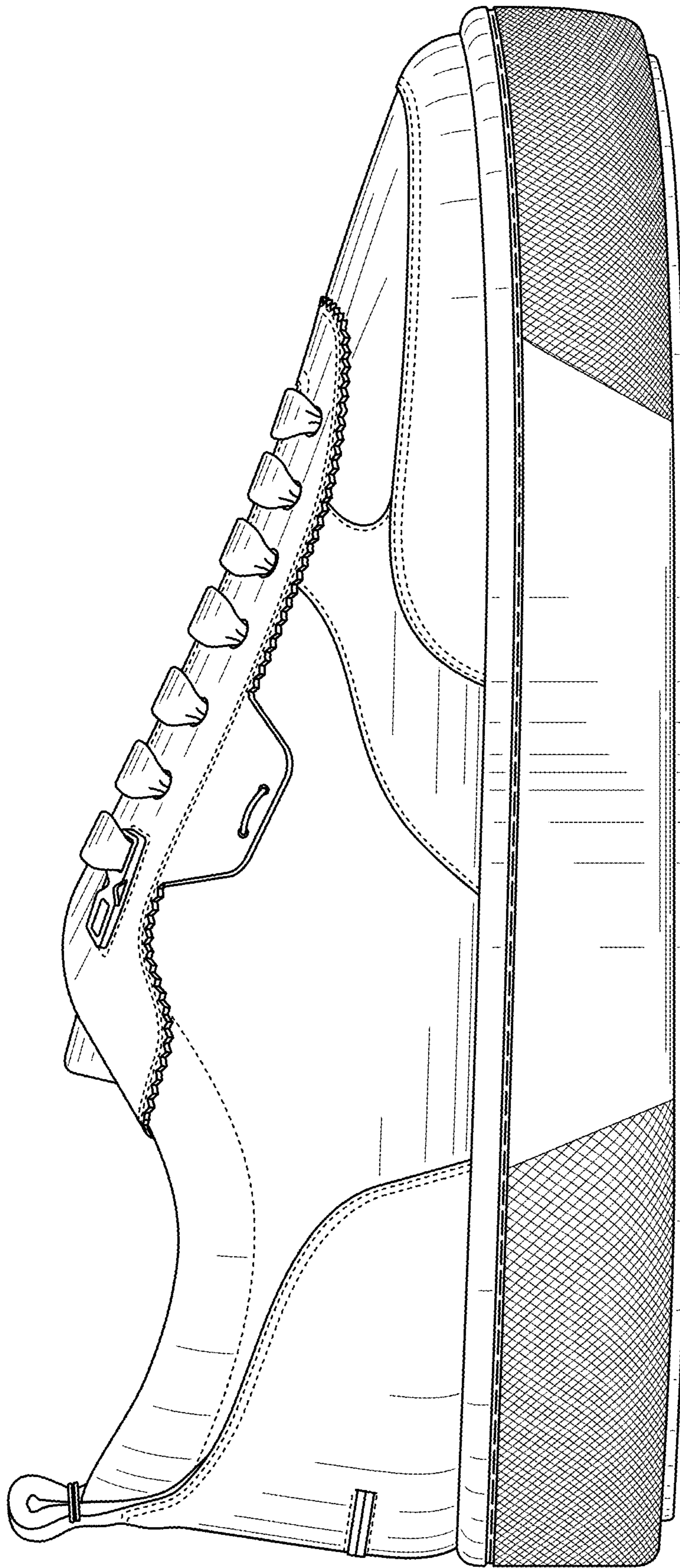

FIG. 12

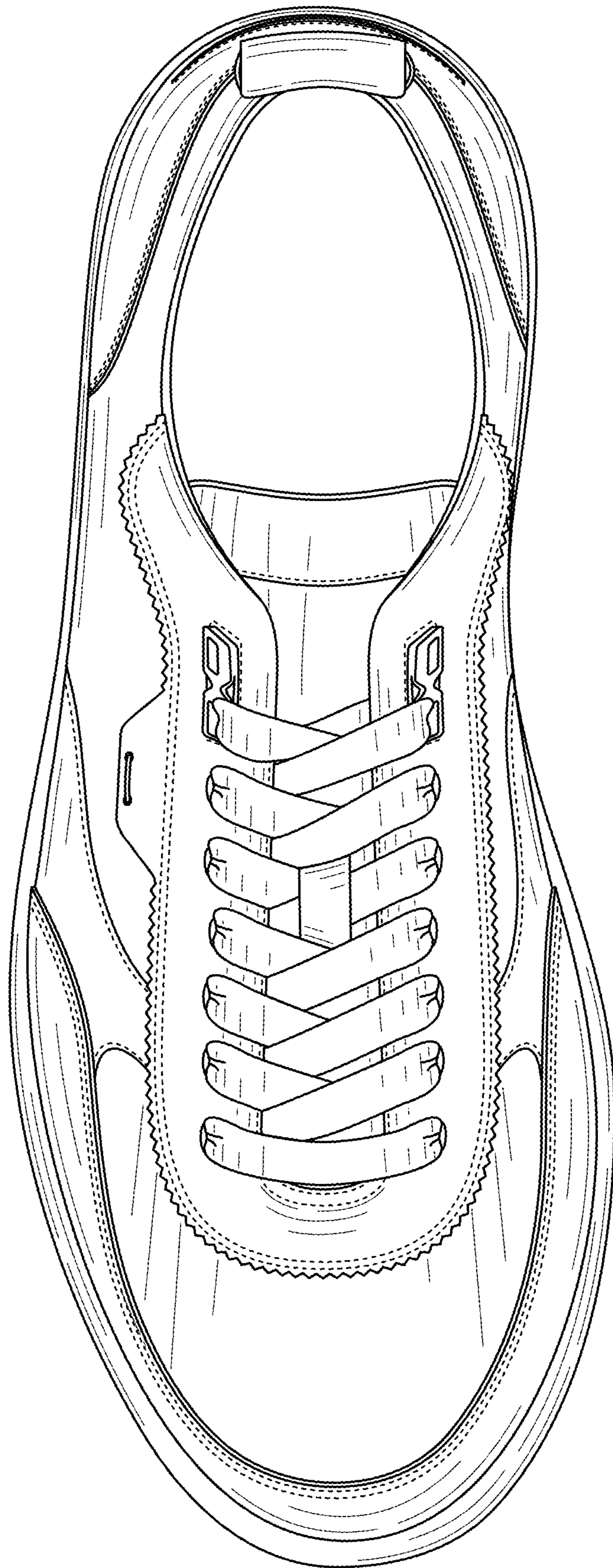

FIG. 13



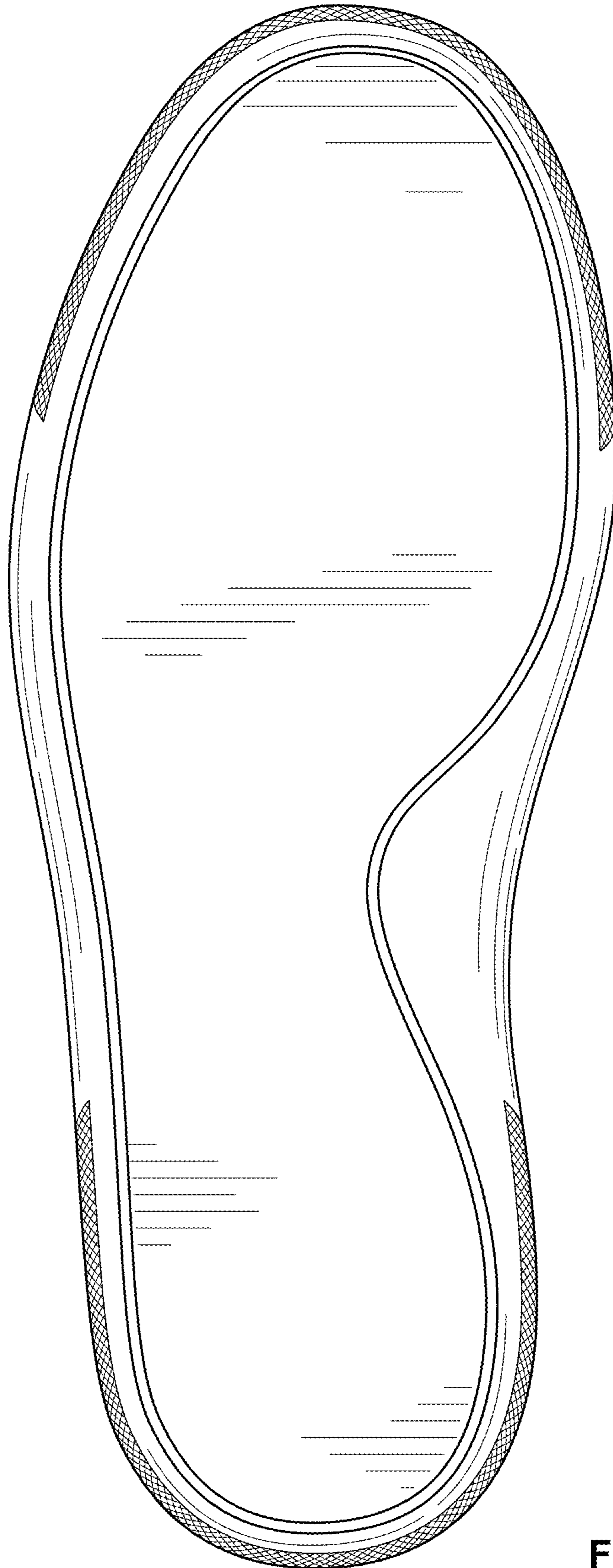

FIG. 14