



US00D935037S

(12) **United States Design Patent** (10) **Patent No.:** **US D935,037 S**
Lowsky (45) **Date of Patent:** **** Nov. 2, 2021**

(54) **ORAL-MOTOR CHEW TOOL**

- (71) Applicant: **ARK Therapeutic Services, Inc.**,
Columbia, SC (US)
- (72) Inventor: **Rebecca E. Lowsky**, Columbia, SC
(US)
- (73) Assignee: **Ark Therapeutic Services, Inc.**,
Columbia, SC (US)

(**) Term: **15 Years**

(21) Appl. No.: **29/712,371**

(22) Filed: **Nov. 7, 2019**

(51) **LOC (13) Cl.** **24-04**

(52) **U.S. Cl.**
USPC **D24/195**

(58) **Field of Classification Search**
USPC D24/193, 194, 195, 208, 214; D30/160;
D1/106, 107, 110, 115, 125; D21/483,
D21/496, 532, 576, 603, 615, 622, 650
CPC A61J 17/02; A61J 17/111; A61J 2200/44
See application file for complete search history.

(56) **References Cited**

U.S. PATENT DOCUMENTS

D298,777 S *	11/1988	Gorman	D24/194
D325,804 S *	5/1992	Meyers, Jr.	D1/109
D395,516 S *	6/1998	Fletcher	D24/195
D493,493 S *	7/2004	Howard	D20/27
D515,273 S *	2/2006	Haro	D1/106
D575,187 S *	8/2008	Mitchell	D11/95
D787,691 S *	5/2017	Jones Andersson	D24/195
D844,909 S *	4/2019	Crane	D30/160
D885,595 S *	5/2020	Luntz	D24/195
D913,146 S *	3/2021	May	D11/82
2003/0236556 A1 *	12/2003	Dickerson	A61J 17/02 606/235
2013/0053885 A1 *	2/2013	Sarver	A61J 17/02 606/235
2014/0243895 A1 *	8/2014	Kellogg	A63H 33/006 606/235

OTHER PUBLICATIONS

- “ARK: Chews Mix”. Found online Jul. 11, 2019 at [instagram.com](https://www.instagram.com/p/BhE3J49A2S/). Reference dated Apr. 2, 2018. Retrieved from <https://www.instagram.com/p/BhE3J49A2S/>.*
- “Bumkins: The Flash Teether”. Found online Mar. 12, 2020 at [bumkins.com](https://tineye.com/search/5f7a5bfc40d16853c529dad3549896478cc3f277?page=1&sort=crawl_date&order=asc&extension_ver=chrome-1.3.0.*). Reference dated Feb. 17, 2018. Retrieved from https://tineye.com/search/5f7a5bfc40d16853c529dad3549896478cc3f277?page=1&sort=crawl_date&order=asc&extension_ver=chrome-1.3.0.*
- “Chewbeads: Juniorbeads—Military Dog Tag For Children”. Found online Dec. 12, 2016 at [amazon.com](https://www.amazon.com/Chewbeads-Juniorbeads-Military-Dog-Children/dp/B00NU1ZX6M/ref=cm_cr_ar_p_d_product_top?ie=UTF8&th=1.*). Reference dated Dec. 3, 2014. Retrieved from https://www.amazon.com/Chewbeads-Juniorbeads-Military-Dog-Children/dp/B00NU1ZX6M/ref=cm_cr_ar_p_d_product_top?ie=UTF8&th=1.*

(Continued)

Primary Examiner — Kendra Leslie Hamilton
(74) *Attorney, Agent, or Firm* — Nelson Mullins Riley & Scarborough LLP

(57) **CLAIM**

The ornamental design for an oral-motor chew tool, substantially as shown and described.

DESCRIPTION

FIG. 1 is a top, front, right perspective view of an oral-motor chew tool, showing my new design;
FIG. 2 is a front elevation view thereof;
FIG. 3 is a back elevation view thereof;
FIG. 4 is a left side elevation view thereof;
FIG. 5 is a right side elevation view thereof;
FIG. 6 is a top plan view thereof; and,
FIG. 7 is a bottom plan view thereof.
The broken lines in FIG. 3 depict a portion of the oral-motor chew tool that forms no part of the claimed design.

1 Claim, 5 Drawing Sheets

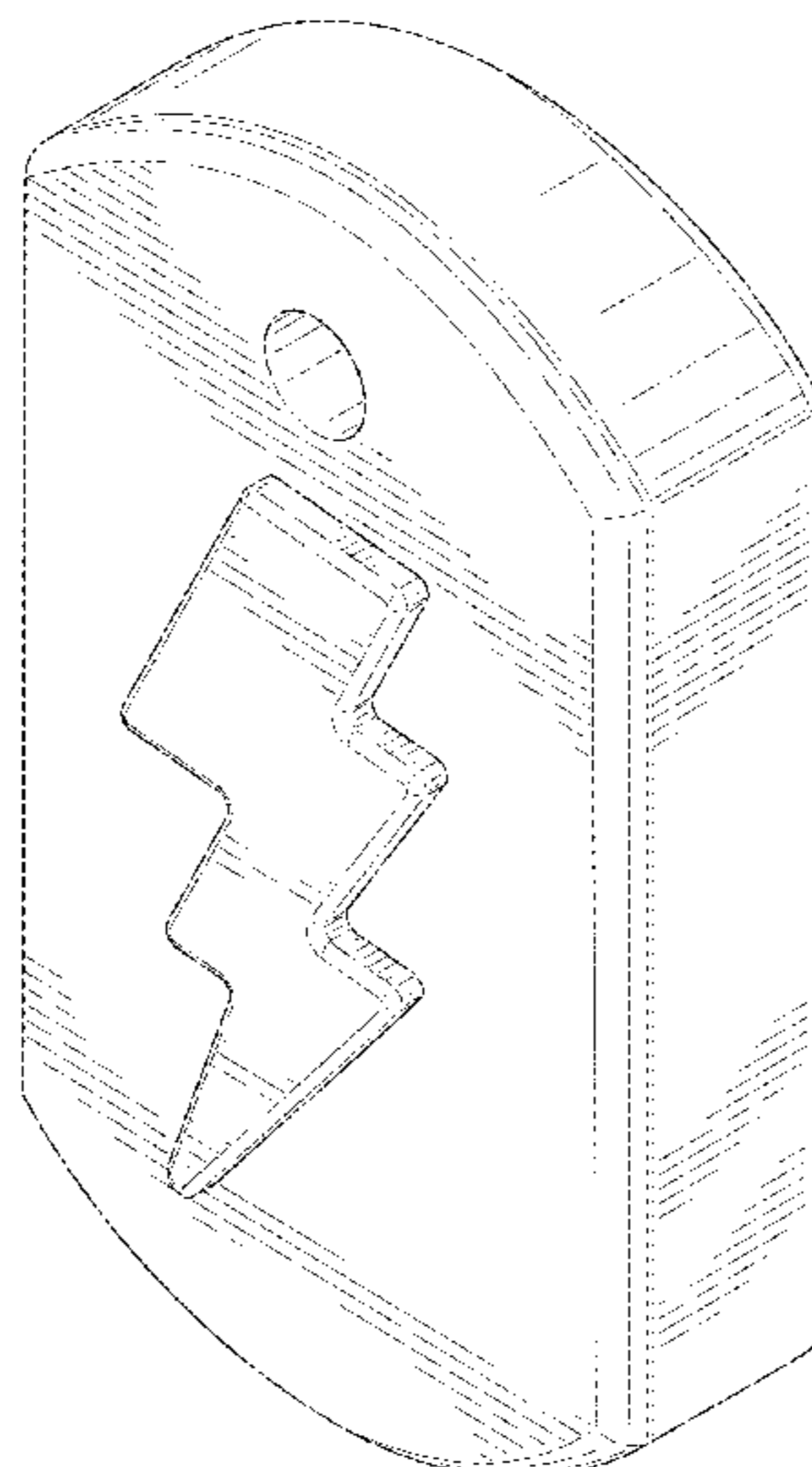

(56)

References Cited

OTHER PUBLICATIONS

Instagram post by arktherapeutic, published at <https://www.instagram.com/p/By9C6sBISrK/> on Jun. 20, 2019, all enclosed pages cited.

Instagram post by arktherapeutic, published at <https://www.instagram.com/p/B3sst4ullVe/> on Oct. 16, 2019, all enclosed pages cited.

Instagram post by arktherapeutic, published at https://www.instagram.com/p/B3Df_B_nZPD/ on Sep. 30, 2019, all enclosed pages cited.

Instagram post by arktherapeutic, published at <https://www.instagram.com/p/B25N81-IDza/> on Sep. 26, 2019, all enclosed pages cited.

Instagram post by arktherapeutic, published at https://www.instagram.com/p/B4f_5MsHAii/ on Nov. 5, 2019, all enclosed pages cited.

* cited by examiner

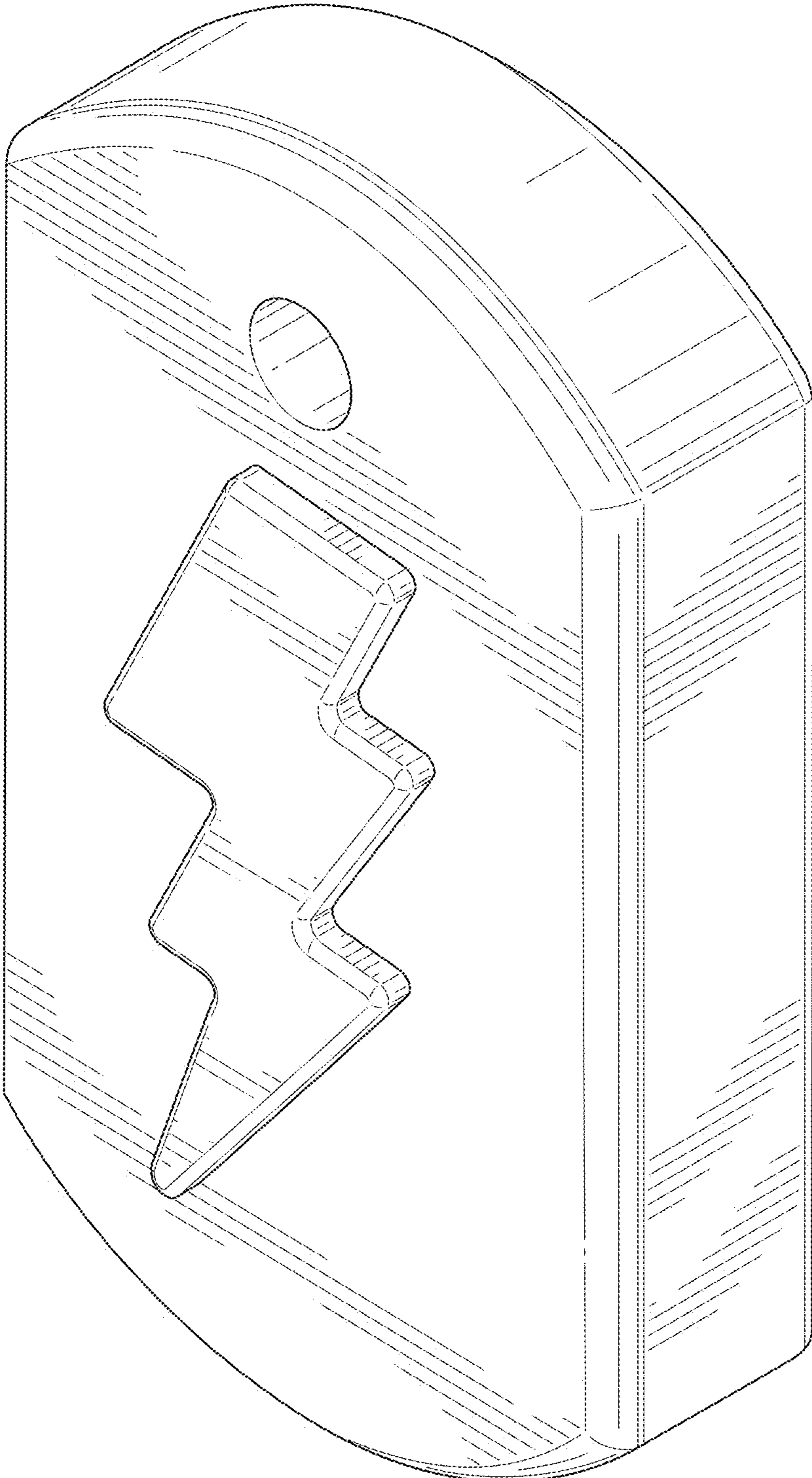

FIG. 1

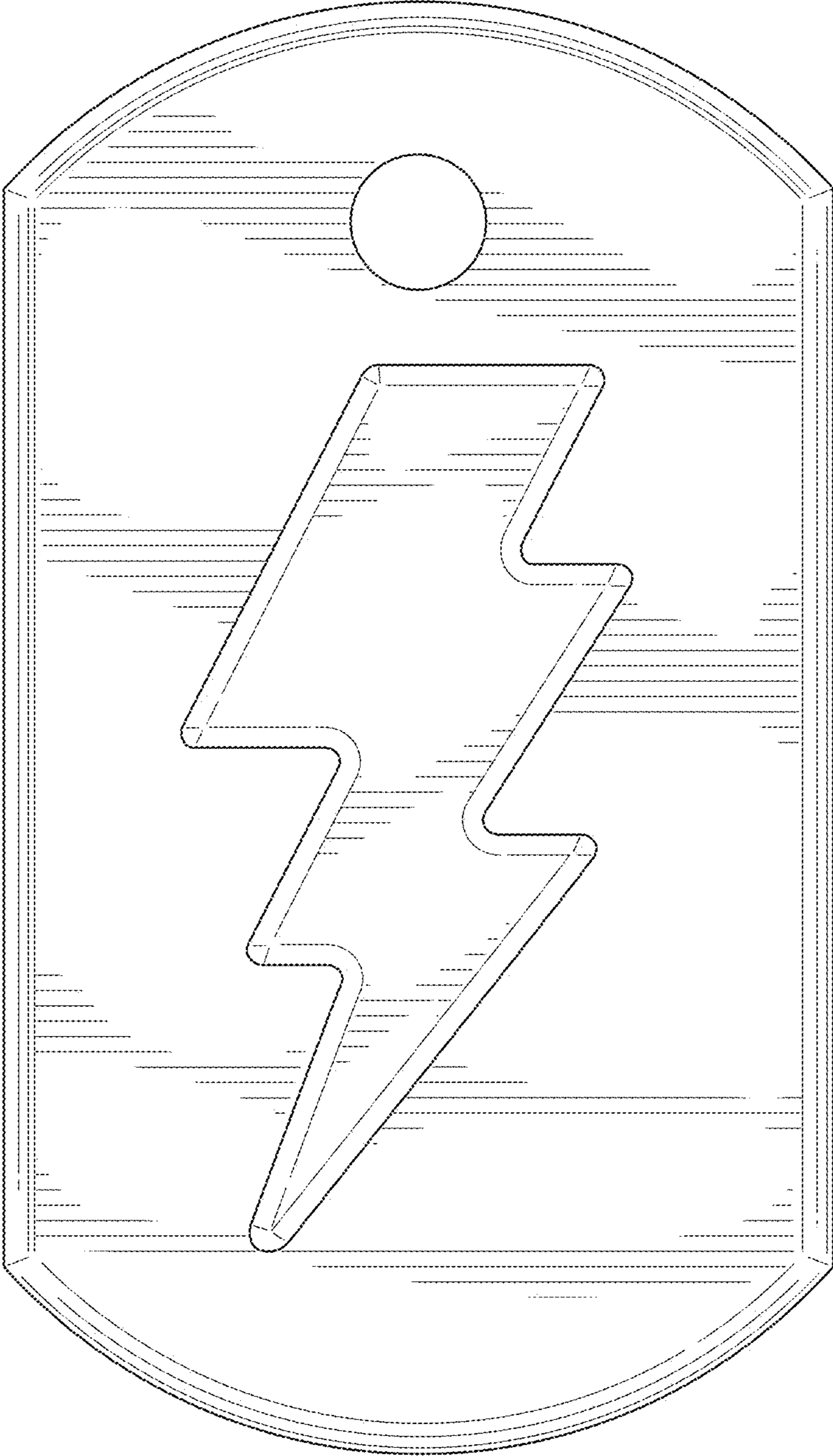

FIG. 2

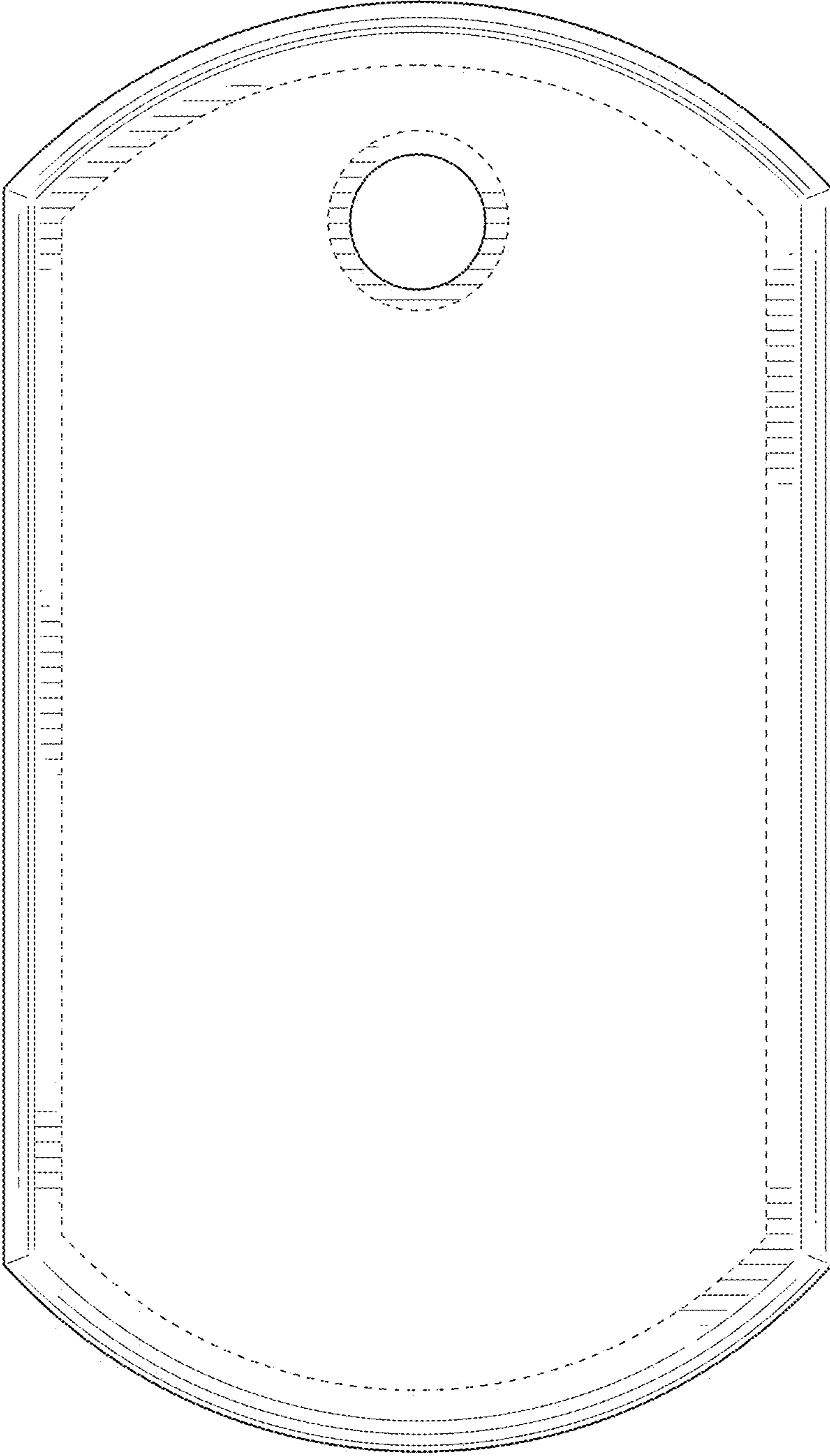

FIG. 3

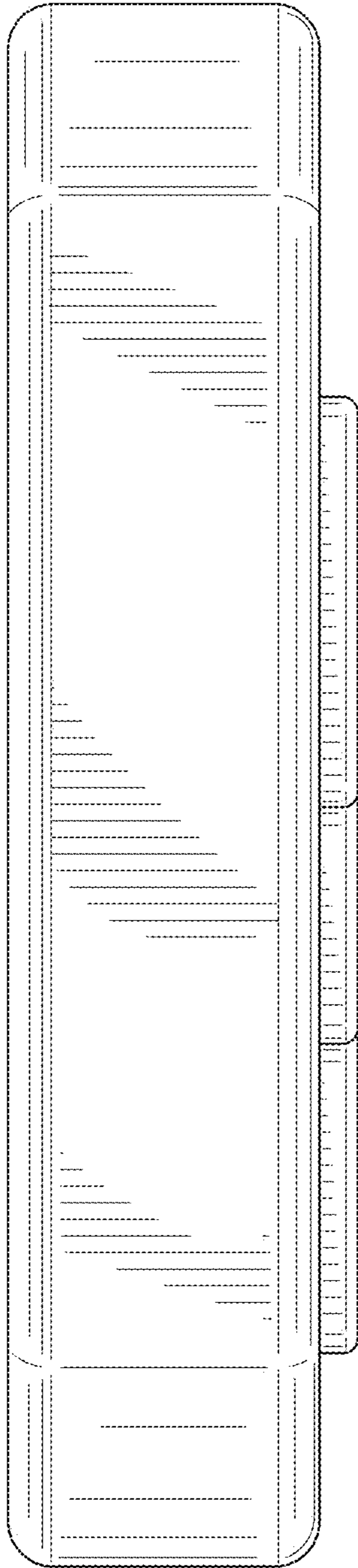

FIG. 4

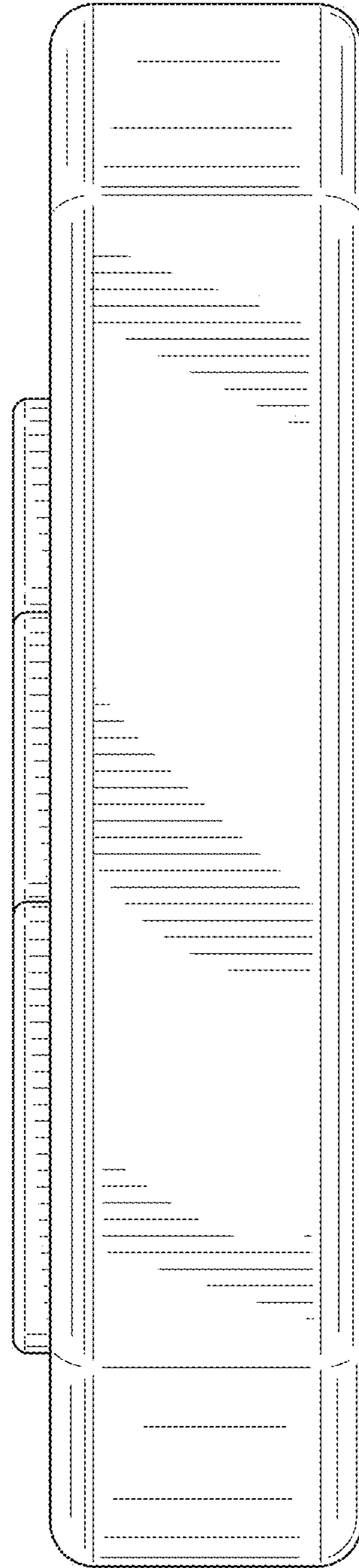

FIG. 5

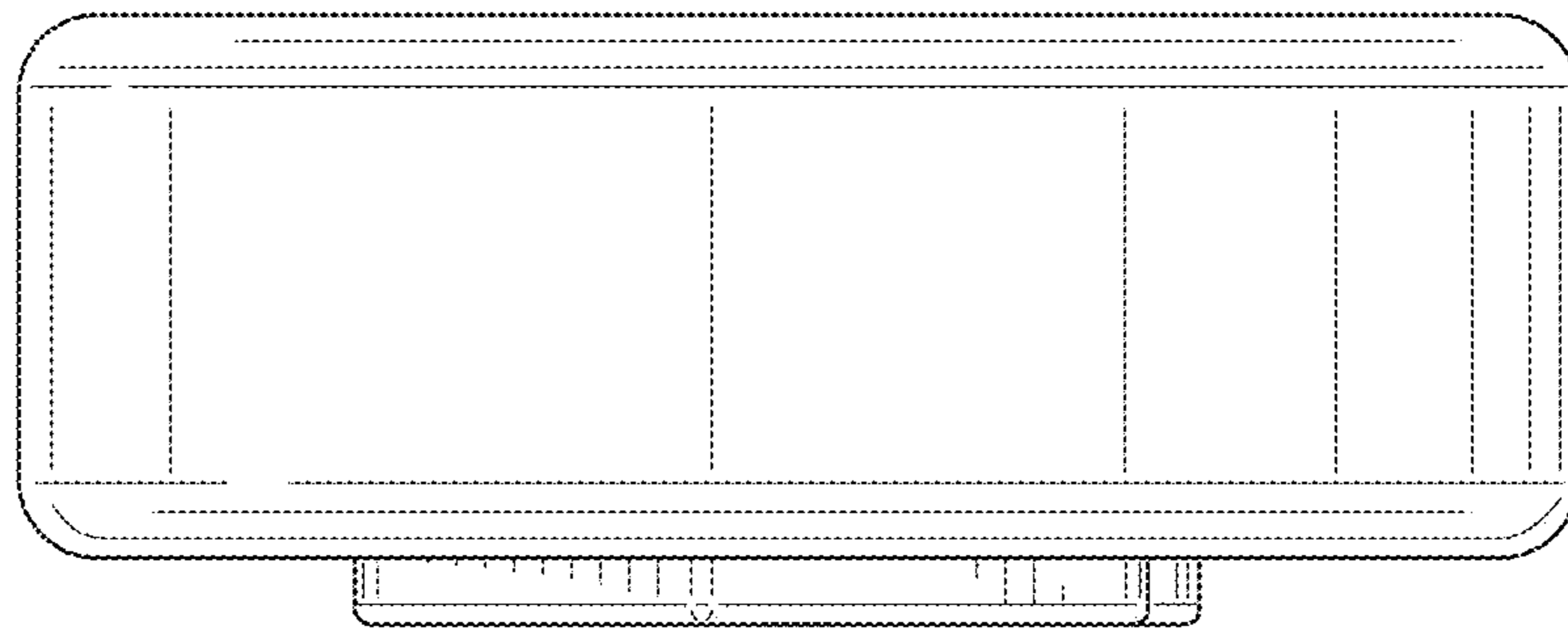

FIG. 6

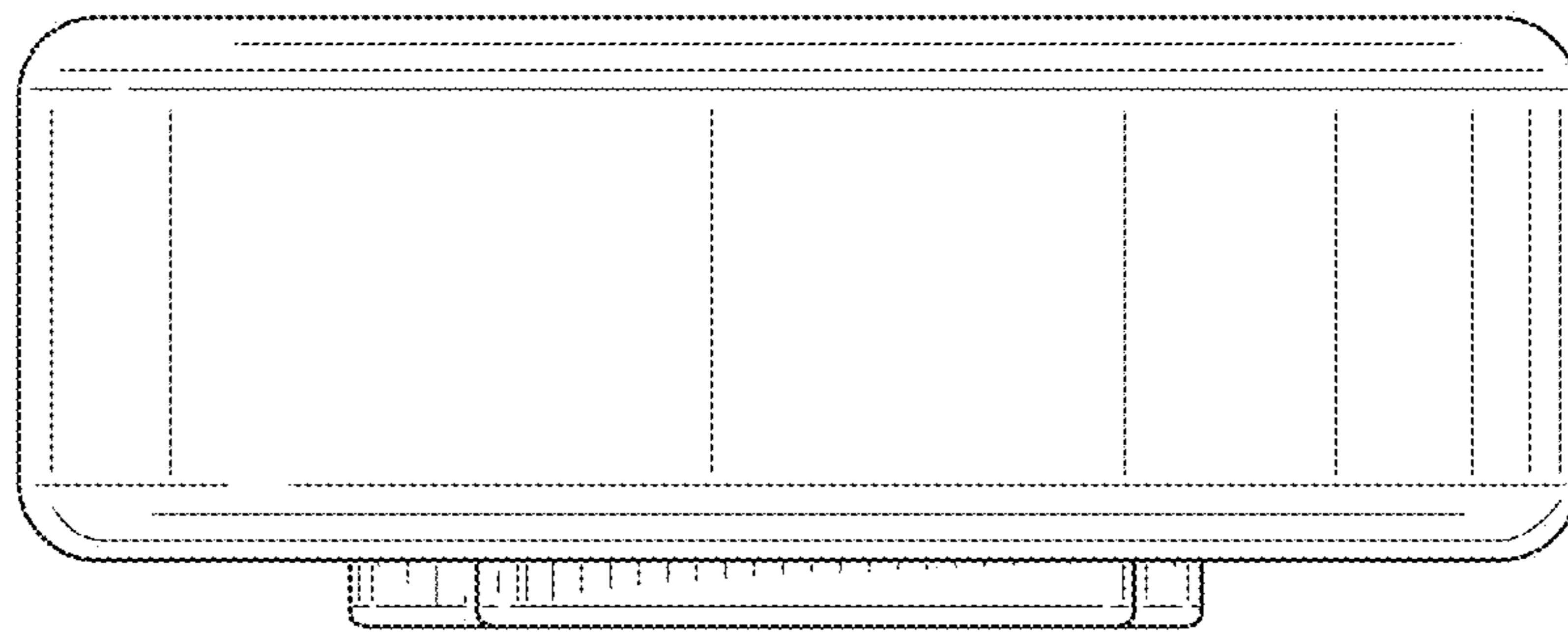

FIG. 7