



US00D934879S

(12) **United States Design Patent** (10) **Patent No.:** **US D934,879 S**
Seo et al. (45) **Date of Patent:** **** Nov. 2, 2021**

(54) **MONITOR**

2200/08; F16M 11/2021; A47B 21/0314;
A47B 88/044; A47B 2021/0335; H02G
3/126;

(71) Applicant: **Samsung Electronics Co., Ltd.**,
Suwon-si (KR)

(Continued)

(72) Inventors: **Young-Jin Seo**, Suwon-si (KR);
Tae-Yeon Won, Suwon-si (KR)

(56) **References Cited**

U.S. PATENT DOCUMENTS

(73) Assignee: **SAMSUNG ELECTRONICS CO., LTD.**,
Suwon-si (KR)

D295,415 S * 4/1988 Thies D14/452
D622,233 S * 8/2010 Shin D14/126
D670,256 S * 11/2012 Kim D14/126

(Continued)

(**) Term: **15 Years**

(21) Appl. No.: **29/735,811**

FOREIGN PATENT DOCUMENTS

(22) Filed: **May 25, 2020**

CN 303816374 8/2016
CN 304359362 11/2017

(30) **Foreign Application Priority Data**

(Continued)

Nov. 27, 2019 (KR) 30-2019-0056924

Primary Examiner — Katie Jane Stofko

(51) **LOC (13) Cl.** **14-02**

(74) *Attorney, Agent, or Firm* — McAndrews Held & Malloy, Ltd.

(52) **U.S. Cl.**

USPC **D14/451**

(58) **Field of Classification Search**

(57) **CLAIM**

USPC D14/371-382, 125-129, 335-337,
D14/447-452, 492, 376, 239, 457,
D14/439-441, 432, 251-253, 126;
D8/349, 354, 363, 373, 376, 380;
348/180, 184, 325, 739, 825; D12/407,
D12/415; D3/218; 341/12

The ornamental design for a monitor, as shown and described.

CPC G06F 3/0412; G06F 3/016; G06F 3/0488;
G06F 3/011; G06F 3/038; G06F 3/03543;
G06F 3/0338; G06F 3/0202; G06F
3/0219; G06F 3/0213; G06F 1/1616;
G06F 3/023; G06F 3/04883; G02F
1/13338; G02F 1/1313; G02F 1/1333;
G02F 1/135; G02F 1/132; G02F
1/133308; G02F 1/134309; G02F
1/13718; G09G 3/3648; G06K 15/1252;
B41J 2/465; G03F 7/70291; G02B
27/0172; G02B 5/30; G02B 2027/0118;
G02B 27/0101; F16M 13/02; F16M
13/00; F16M 11/10; F16M 11/04; F16M

DESCRIPTION

FIG. 1 is a front perspective view of a monitor showing our new design;
FIG. 2 is a front elevation view thereof;
FIG. 3 is a rear elevation view thereof;
FIG. 4 is a left side elevation view thereof;
FIG. 5 is a right side elevation view thereof;
FIG. 6 is a top plan view thereof;
FIG. 7 is a bottom plan view thereof; and,
FIG. 8 is a rear perspective view thereof.
The evenly dashed broken lines in the drawings illustrate portions of the monitor that form no part of the claimed design.

(Continued)

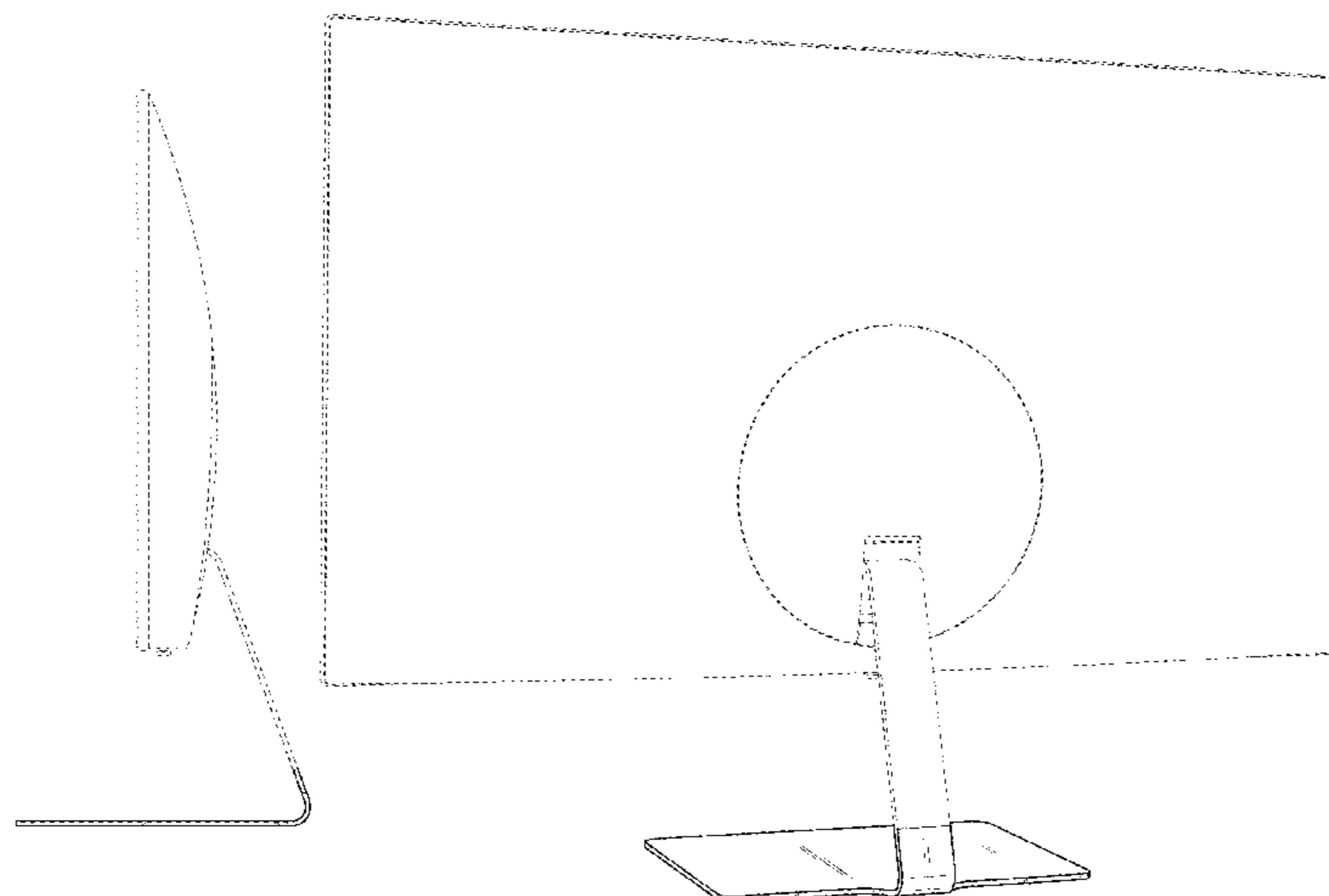

The dot-dash broken lines in the drawings define the boundary of the claimed design and form no part thereof.

1 Claim, 8 Drawing Sheets

(58) Field of Classification Search

CPC F16B 47/00; F16B 47/006; A47G 1/17;
A47K 2201/00

See application file for complete search history.

(56) References Cited

U.S. PATENT DOCUMENTS

D696,666	S	*	12/2013	Drew	D14/375
D703,631	S	*	4/2014	Hallar	D14/129
D724,040	S	*	3/2015	Chan	D14/126
D727,923	S	*	4/2015	Yum	D14/451
D757,021	S	*	5/2016	Won	D14/451
D776,668	S		1/2017	Wallace et al.		
D787,522	S	*	5/2017	Lee	D14/451
D819,029	S	*	5/2018	Seo	D14/374
D819,030	S	*	5/2018	Seo	D14/374
D822,669	S	*	7/2018	Kwon	D14/451
D905,650	S	*	12/2020	Lee	D14/126

FOREIGN PATENT DOCUMENTS

CN	305216820	6/2019
WO	DM/099715	8/2018

* cited by examiner

FIG. 1

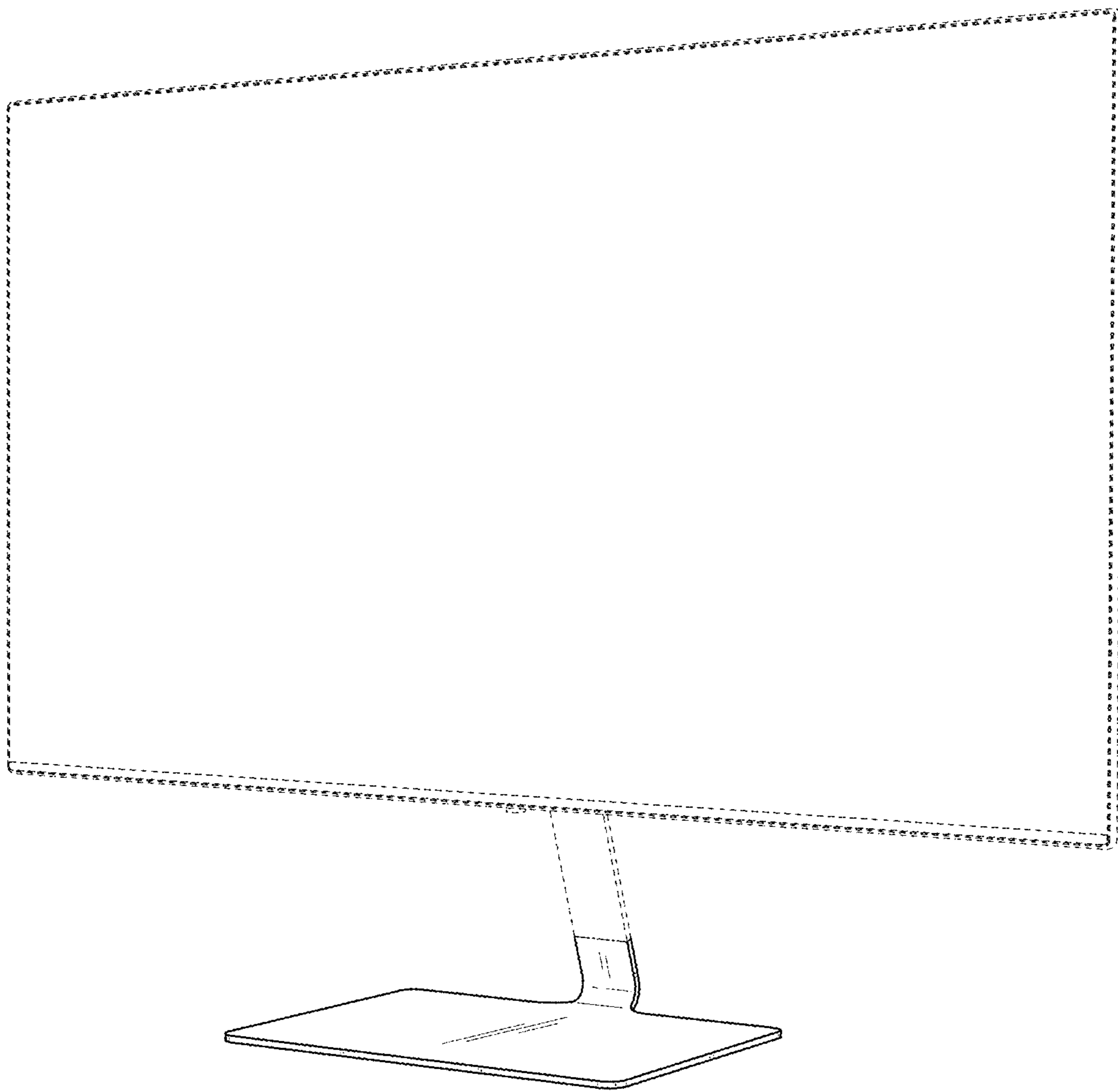

FIG. 2

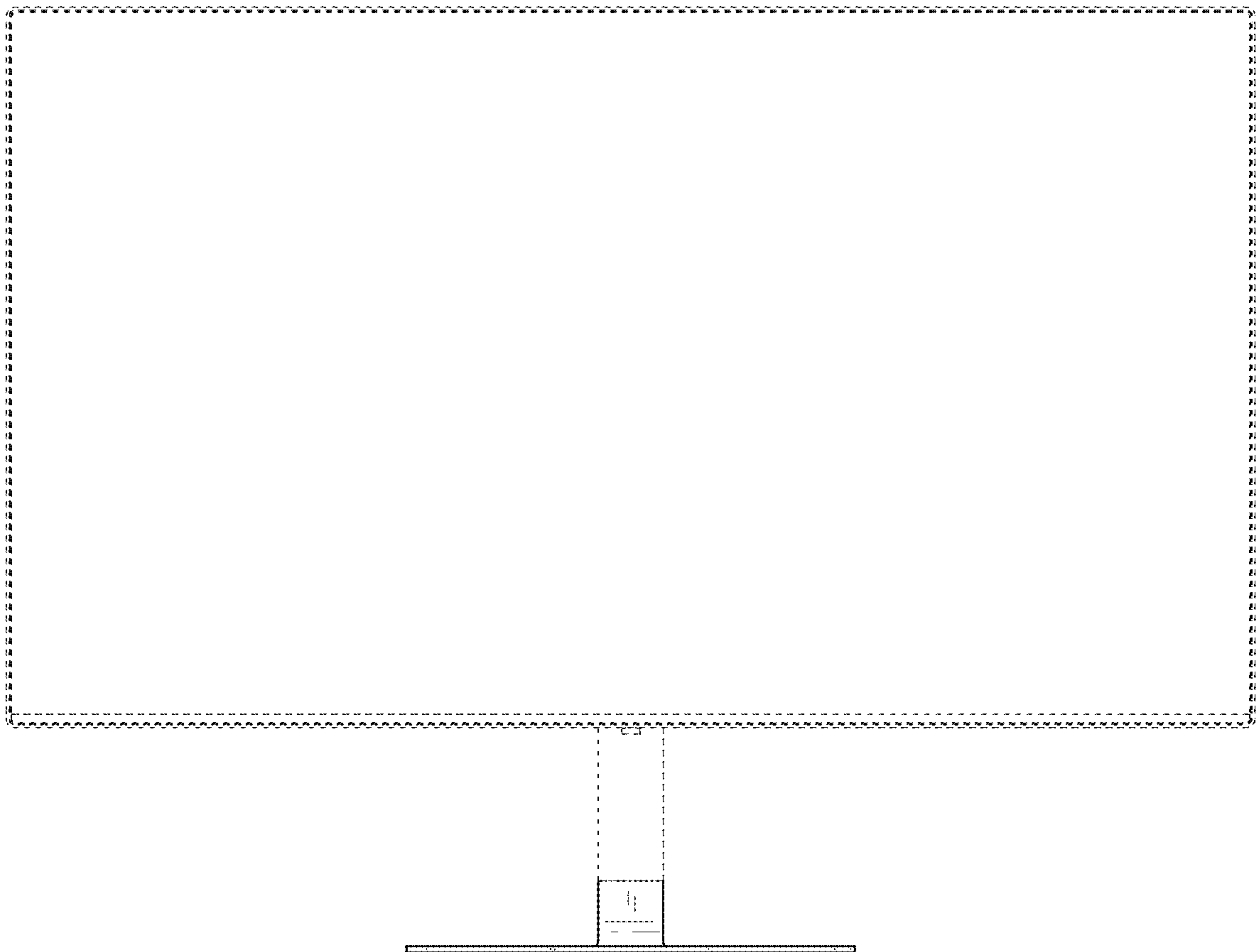

FIG. 3

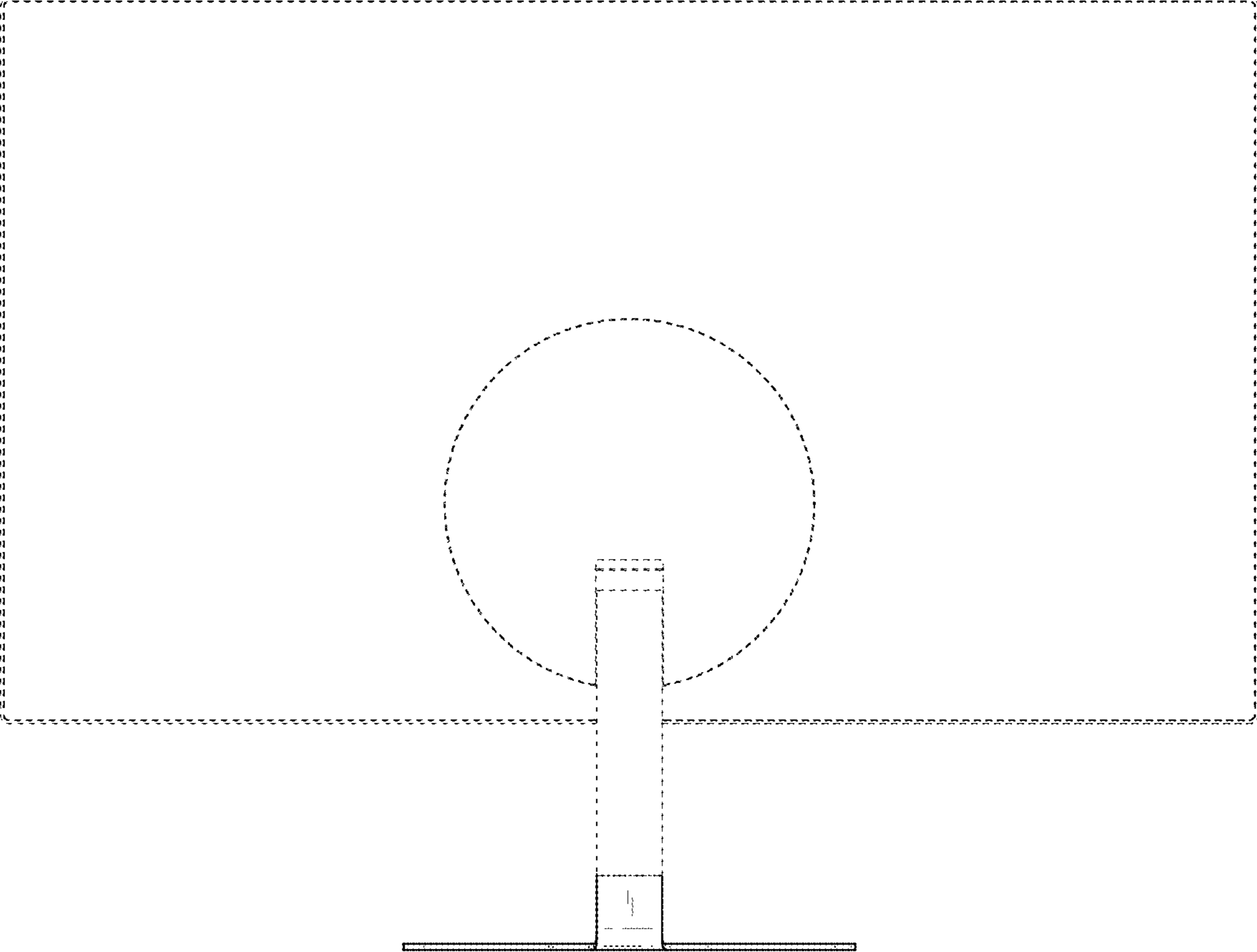

FIG. 4

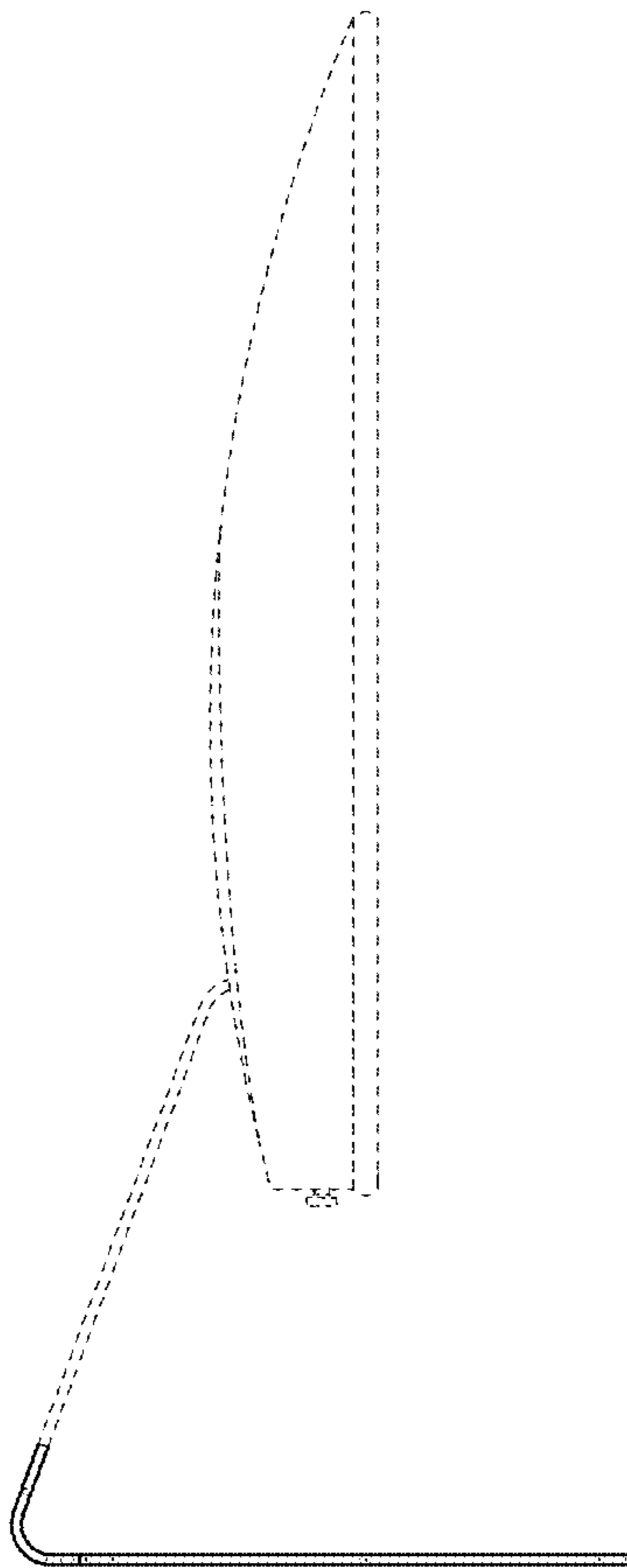

FIG. 5

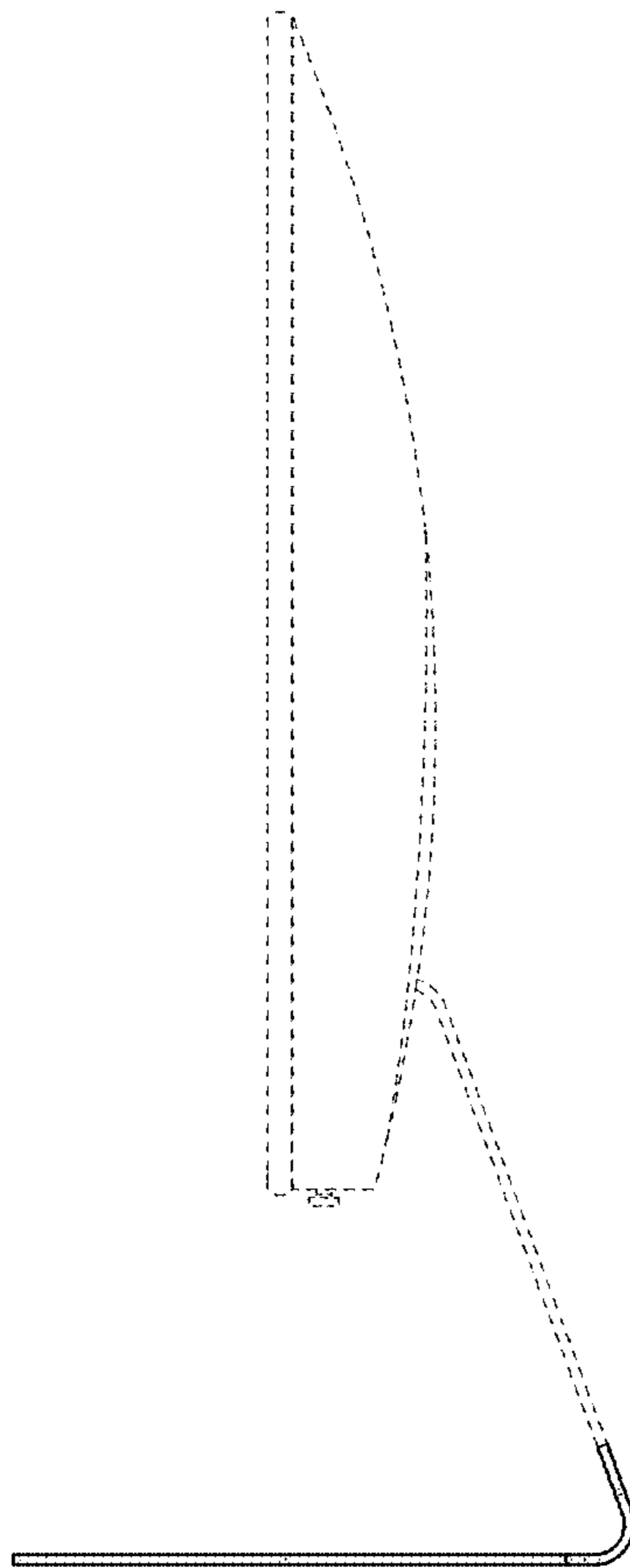

FIG. 6

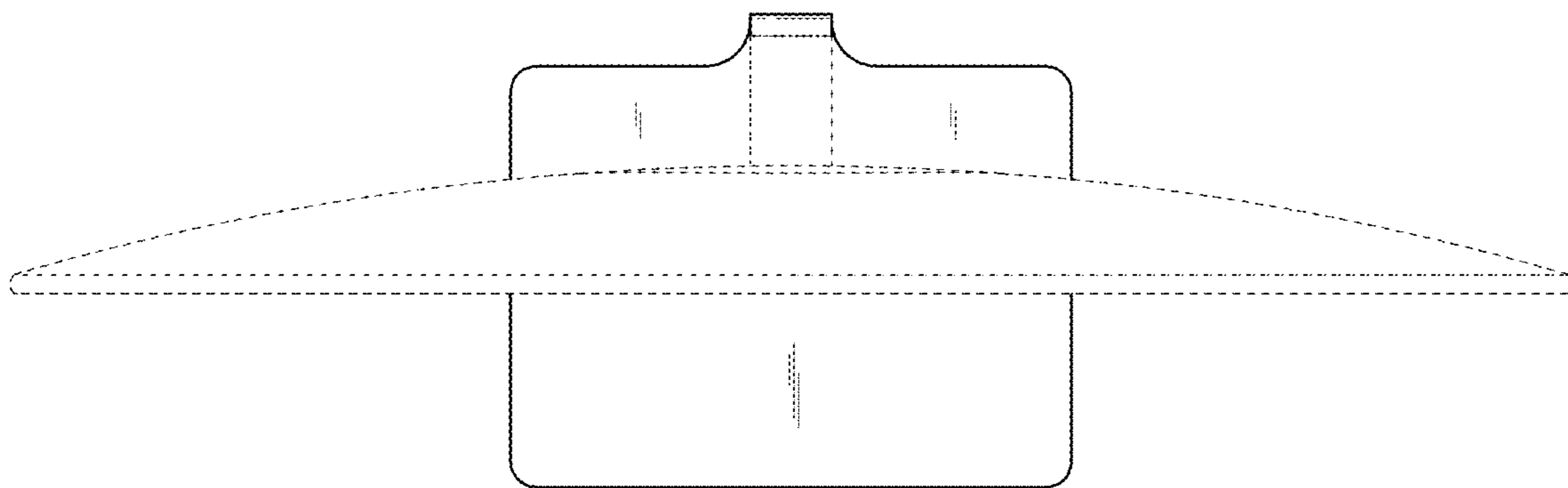

FIG. 7

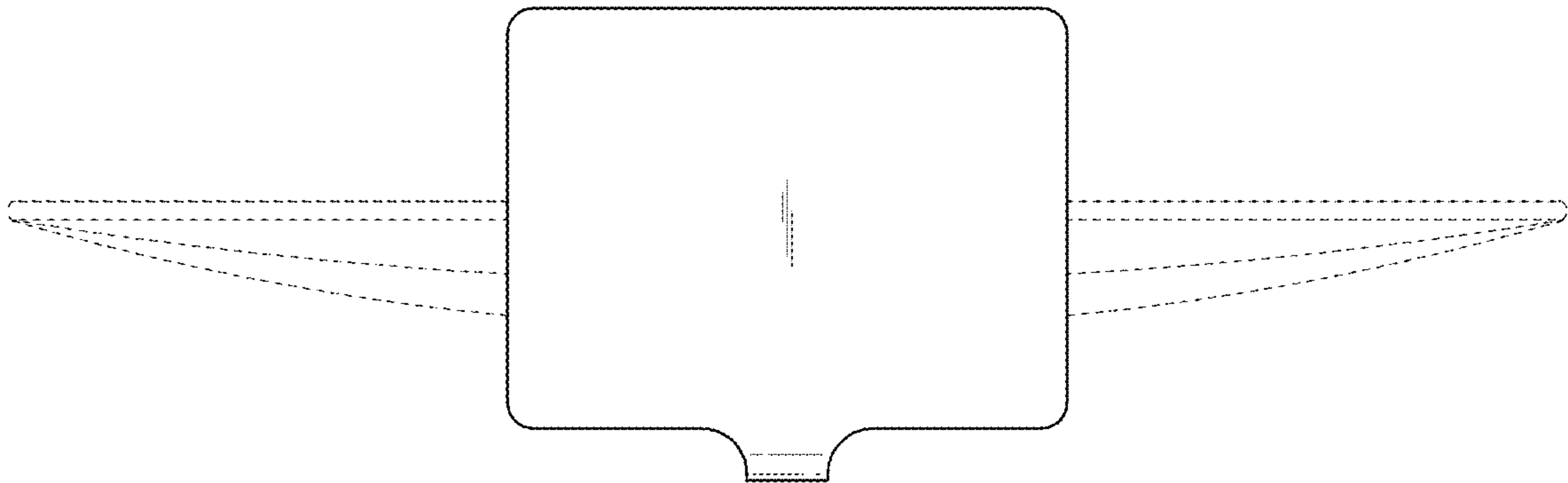

FIG. 8

