



US00D934827S

(12) **United States Design Patent** (10) **Patent No.:** **US D934,827 S**  
**Stinson et al.** (45) **Date of Patent:** **\*\* Nov. 2, 2021**

(54) **PEDESTAL DIGITAL OUTDOOR DISPLAY**

(71) Applicant: **Melitron Corporation**, Guelph (CA)

(72) Inventors: **Kelly Stinson**, Cambridge (CA);  
**Michael Turner**, Guelph (CA)

(73) Assignee: **Melitron Corporation**, Guelph (CA)

(\*\*) Term: **15 Years**

(21) Appl. No.: **29/768,036**

(22) Filed: **Jan. 27, 2021**

**Related U.S. Application Data**

(62) Division of application No. 29/680,914, filed on Feb. 21, 2019, now Pat. No. Des. 911,992.

(51) **LOC (13) Cl.** ..... **14-03**

(52) **U.S. Cl.**  
USPC ..... **D14/126**

(58) **Field of Classification Search**  
USPC ..... D6/300, 310, 512, 524, 545; D14/126,  
D14/300, 301, 302, 307, 371, 374, 900,  
D14/901, 902; D19/113; D20/10, 18,  
D20/19, 20, 41, 42, 99  
CPC ..... G09F 13/00; G09F 13/04; G09F 13/08;  
G09F 13/20; G09F 19/00; G09F 19/02;  
G09F 19/10; G06Q 20/18; G06Q 20/123;  
A47F 9/047

See application file for complete search history.

(56) **References Cited**

**U.S. PATENT DOCUMENTS**

1,848,951 A \* 3/1932 Haynes ..... G09F 13/04  
40/555  
D227,599 S \* 7/1973 Wisgin ..... D20/41  
D279,201 S \* 6/1985 Shuman ..... D20/10  
D310,359 S \* 9/1990 Inukai ..... D14/374  
D398,653 S \* 9/1998 Hiraguchi ..... D20/10

D455,788 S \* 4/2002 Gentelia ..... D20/10  
D461,785 S \* 8/2002 Wilmotte ..... D14/126  
D472,223 S \* 3/2003 Wilmotte ..... D14/126  
D493,463 S \* 7/2004 Takahashi ..... D14/345  
D639,086 S \* 6/2011 Curbbun ..... D20/10  
D639,800 S \* 6/2011 Magruder ..... D14/307  
D646,269 S \* 10/2011 Crick, Jr. .... D14/307

(Continued)

**OTHER PUBLICATIONS**

Peerless—AV digital menu board, Published date unavailable [online], [retrieved on Jun. 22, 2021]. Retrieved from the Internet: <https://www.peerless-av.com/products/kof-xhb> (Year: 2021).\*

(Continued)

*Primary Examiner* — Christian P. McLean

*Assistant Examiner* — Adam C Mager

(57) **CLAIM**

The ornamental design for a pedestal digital outdoor display, as shown and described.

**DESCRIPTION**

FIG. 1 is a perspective view of an embodiment thereof; FIG. 2 is a first side view of the embodiment of FIG. 1; FIG. 3 is a second side view of the embodiment of FIG. 1; FIG. 4 is a front view of the embodiment of FIG. 1; FIG. 5 is a back view of the embodiment of FIG. 1; FIG. 6 is a top view of the embodiment of FIG. 1; FIG. 7 is a bottom view of the embodiment of FIG. 1; FIG. 8 is a perspective view of a second embodiment thereof; and, FIG. 9 is a front view of the second embodiment viewed in FIG. 8.

First and second side views, a back view, and top and bottom views of the second embodiment viewed in FIG. 8 are not provided because they are the same as FIGS. 2, 3, 5, 6, and 7 respectively.

**1 Claim, 7 Drawing Sheets**

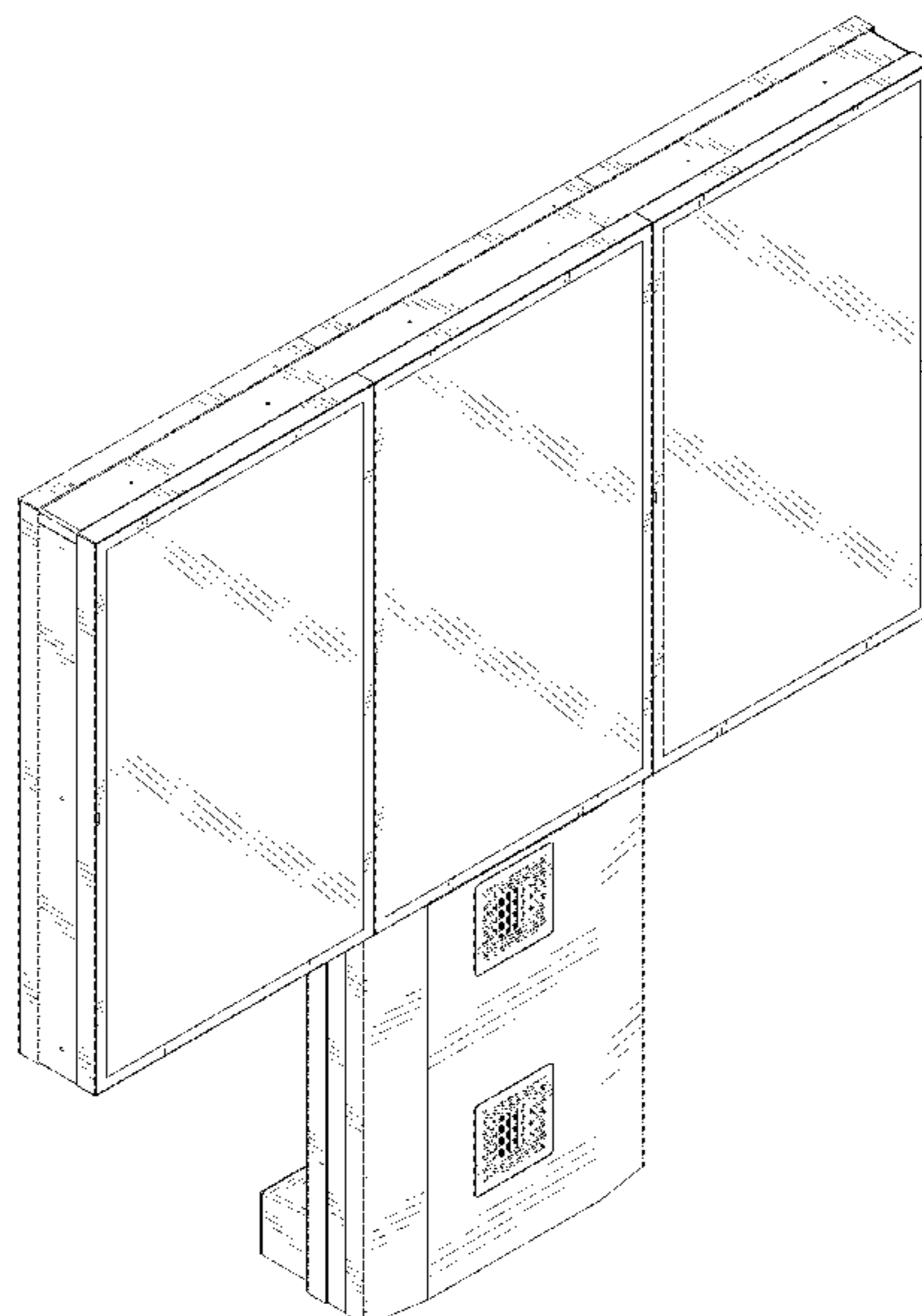

(56)

References Cited

U.S. PATENT DOCUMENTS

D671,535 S \* 11/2012 Terashima ..... D14/307  
 D700,901 S \* 3/2014 Giglio ..... D14/129  
 D708,459 S \* 7/2014 Heirakuji ..... D6/675  
 D708,573 S \* 7/2014 Gieniec ..... D13/107  
 8,976,313 B2 \* 3/2015 Kim ..... G02F 1/133382  
 349/58  
 D727,995 S \* 4/2015 Vilcovsky ..... D16/221  
 D728,557 S \* 5/2015 Soares ..... D14/307  
 D732,015 S \* 6/2015 Alekhin ..... D14/307  
 D734,074 S \* 7/2015 Jouin ..... D6/672  
 D739,464 S \* 9/2015 Liu ..... D19/113  
 D742,455 S \* 11/2015 Denby ..... D20/19  
 D759,617 S \* 6/2016 Soares ..... D14/126  
 D776,651 S \* 1/2017 Yates ..... D14/307  
 D782,467 S \* 3/2017 Bladwell ..... D14/307  
 D783,596 S \* 4/2017 Payne ..... D14/307  
 D850,532 S \* 6/2019 Lee ..... D20/41  
 D861,356 S \* 10/2019 Zhu ..... D6/310  
 10,485,113 B2 \* 11/2019 Dunn ..... G09F 21/04  
 D869,412 S \* 12/2019 Spencer ..... D14/126  
 D869,413 S \* 12/2019 Spencer ..... D14/126

D876,345 S \* 2/2020 Mercer ..... D13/107  
 10,559,965 B2 \* 2/2020 Dunn ..... H05K 5/0086  
 D885,382 S \* 5/2020 Kim ..... D14/371  
 D886,096 S \* 6/2020 Mangeot ..... D14/307  
 D900,221 S \* 10/2020 Dance ..... D20/39  
 D911,992 S \* 3/2021 Stinson ..... D14/126  
 D913,276 S \* 3/2021 Dunn ..... D14/307  
 D920,323 S \* 5/2021 Lee ..... D14/307  
 2008/0236005 A1 \* 10/2008 Isayev ..... G09F 13/04  
 40/574  
 2010/0079979 A1 \* 4/2010 Nakamichi ..... H05K 7/20972  
 362/97.1  
 2016/0132849 A1 \* 5/2016 Melo ..... G06Q 20/3278  
 705/57  
 2019/0026062 A1 \* 1/2019 Seo ..... G09F 27/00  
 2020/0383246 A1 \* 12/2020 Lee ..... H05K 7/20209

OTHER PUBLICATIONS

Melitron Digital Signage, Published date unavailable [online], [retrieved on Jun. 22, 2021]. Retrieved from the Internet: <https://www.melitron.com/digital-signage/> (Year: 2021).\*

\* cited by examiner

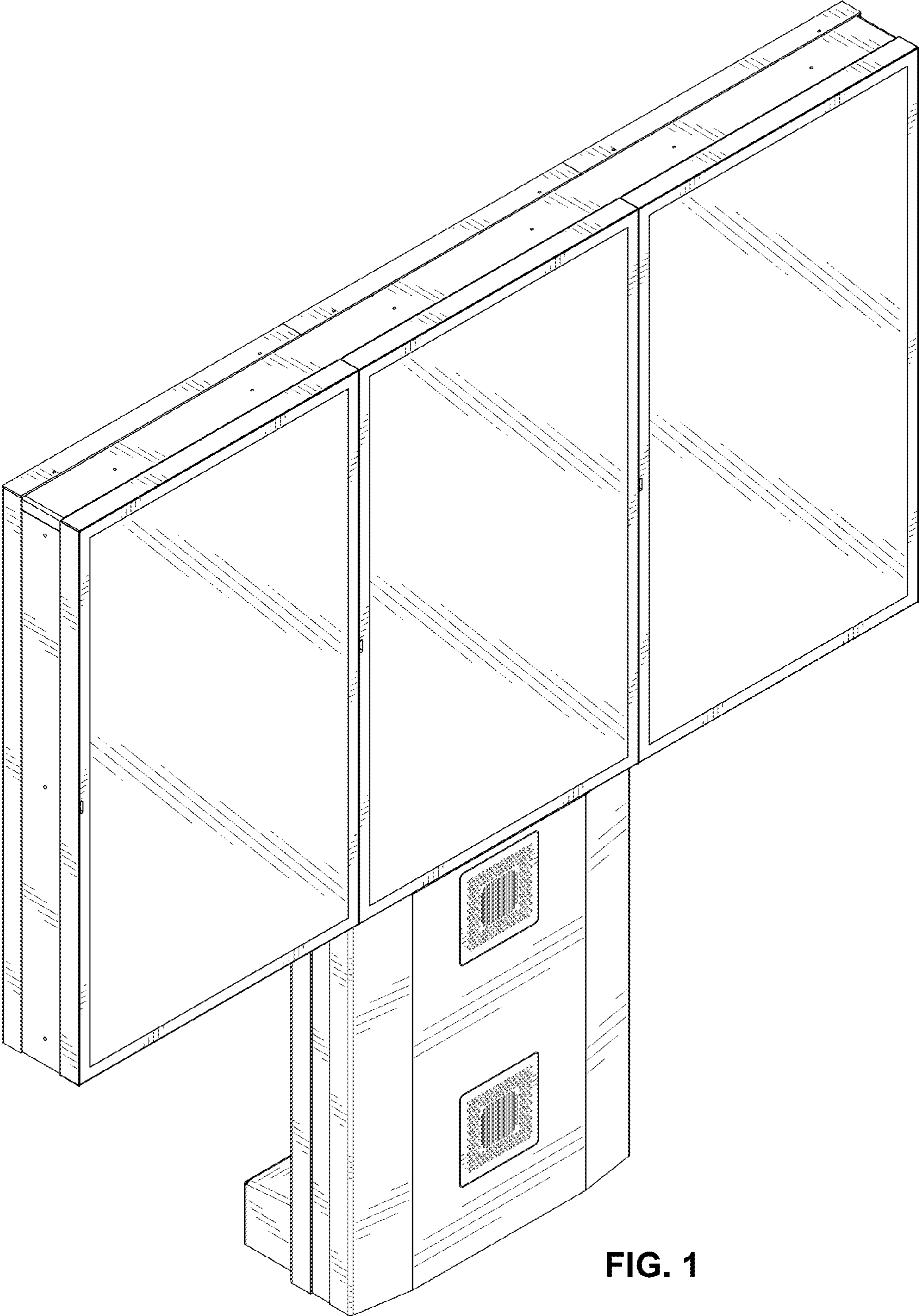

FIG. 1

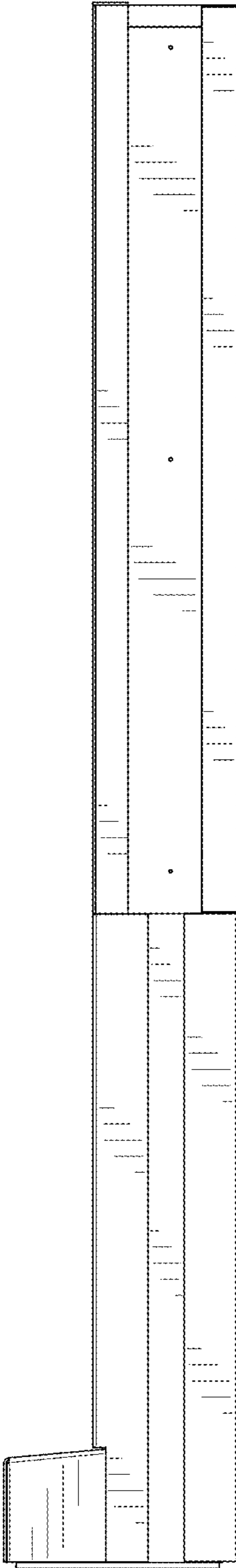

FIG. 2

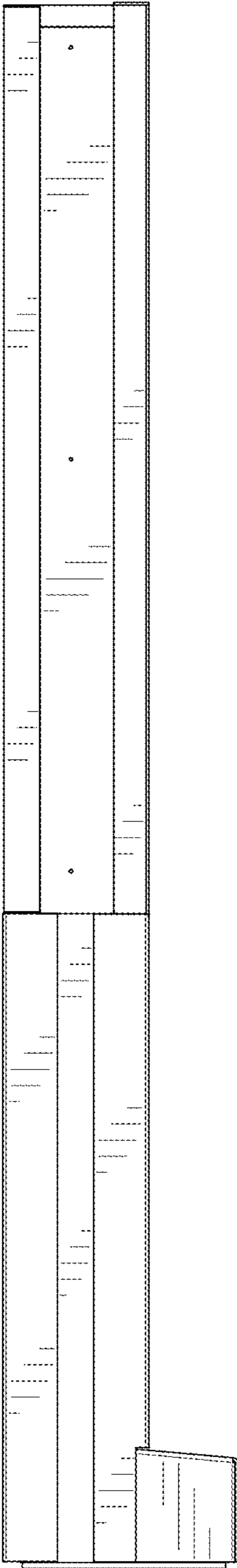

FIG. 3

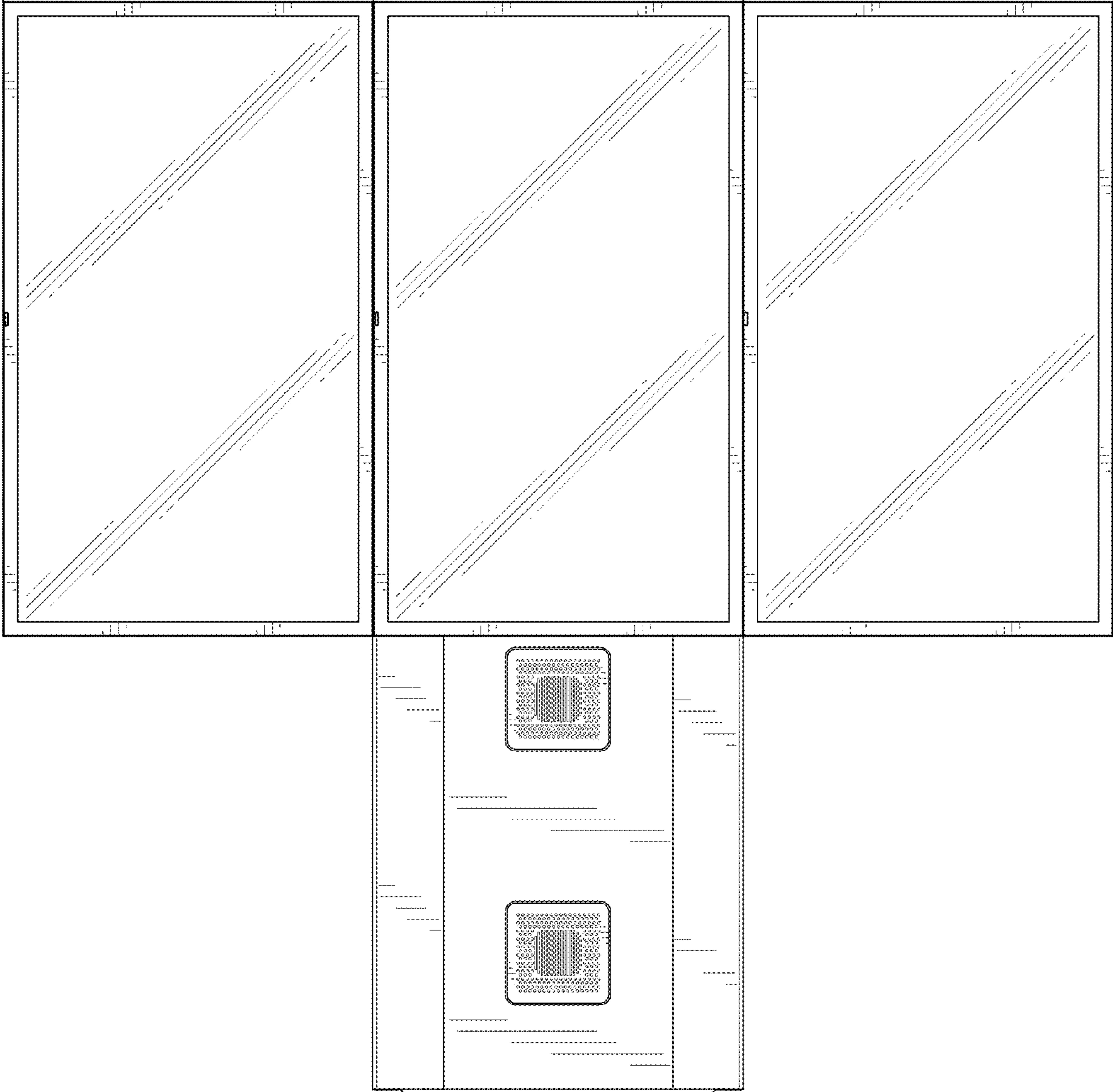

FIG. 4

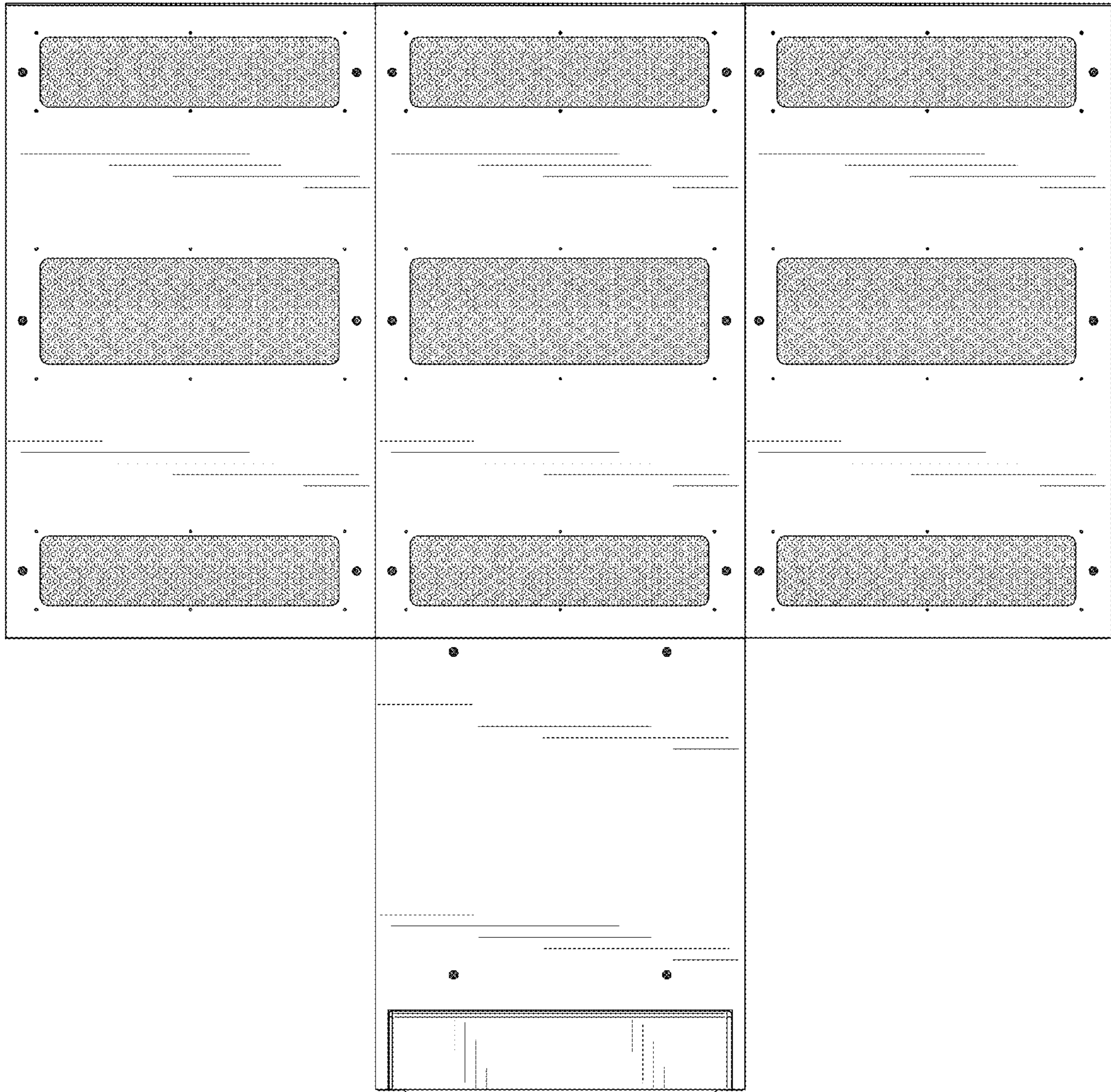

FIG. 5

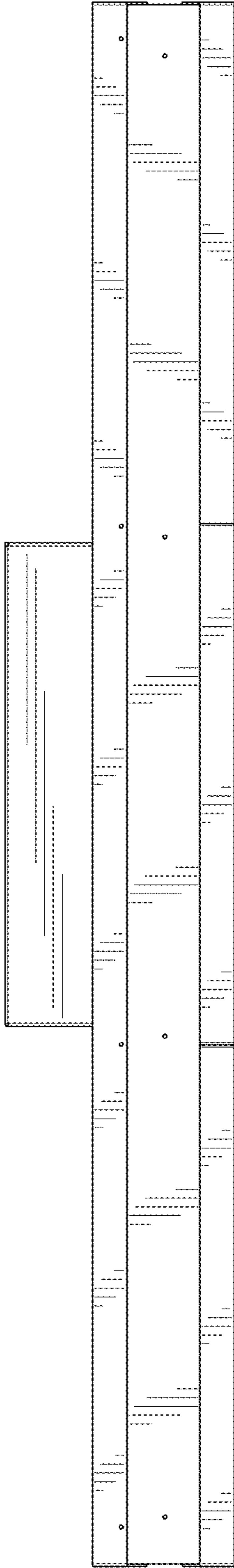

FIG. 6

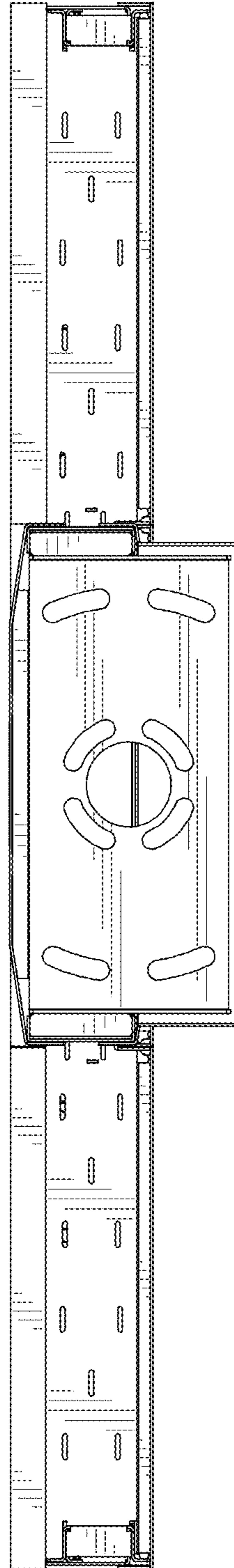

FIG. 7

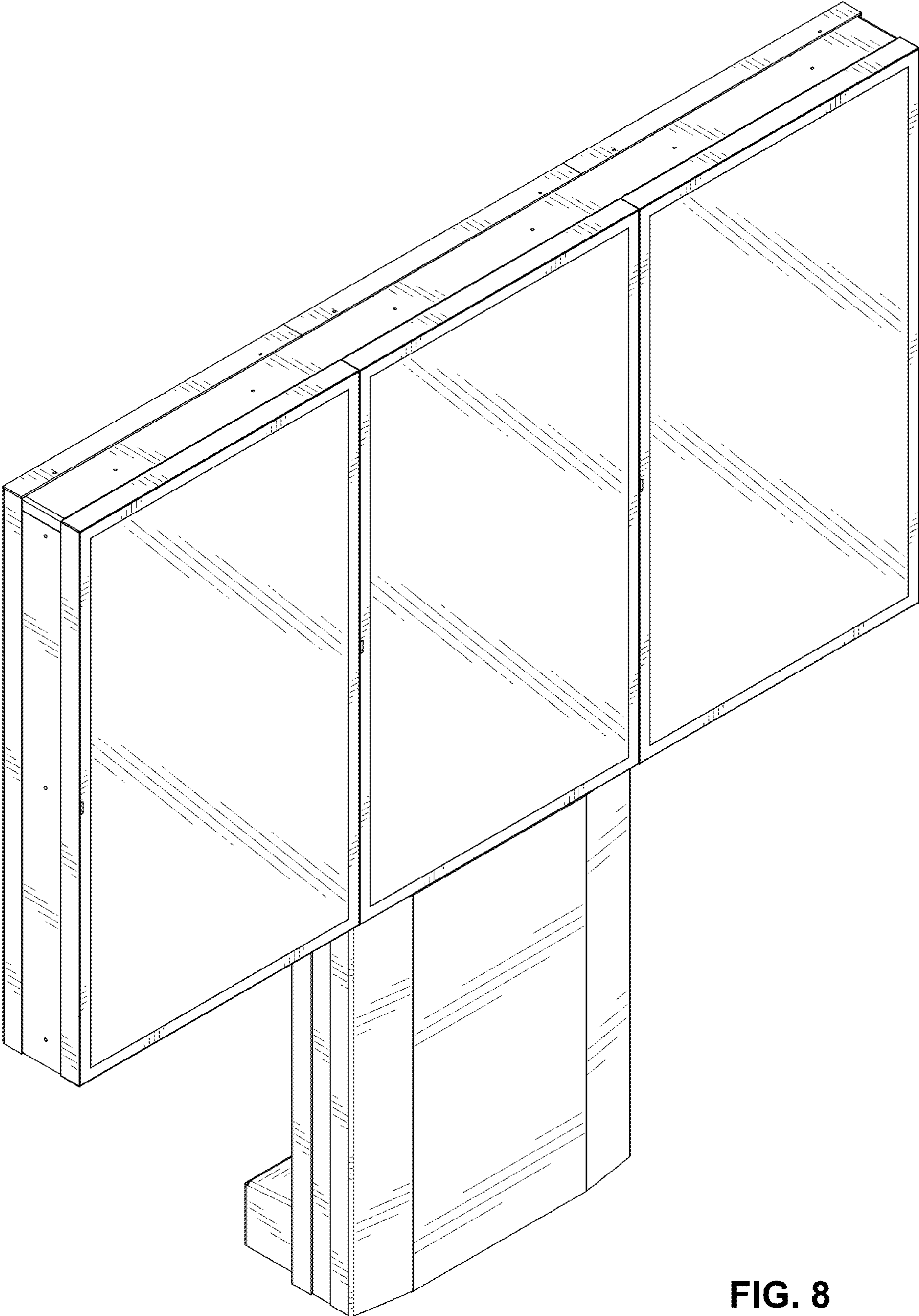
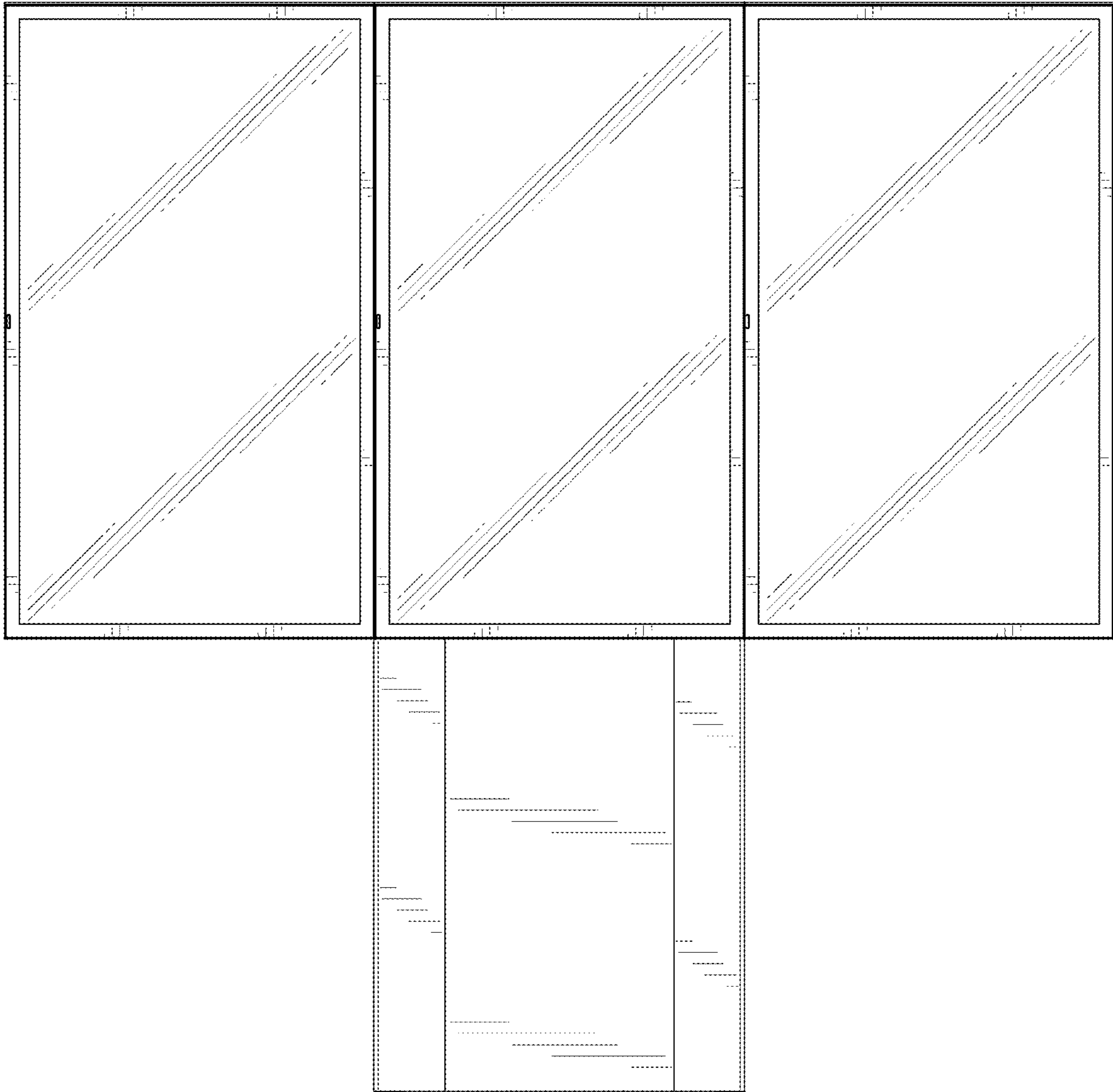

FIG. 8





**FIG. 9**