



US00D934825S

(12) **United States Design Patent**
Pyo et al.

(10) **Patent No.:** **US D934,825 S**

(45) **Date of Patent:** **** Nov. 2, 2021**

(54) **ROLLABLE TELEVISION RECEIVER**

(56) **References Cited**

(71) Applicant: **LG ELECTRONICS INC.**, Seoul (KR)

U.S. PATENT DOCUMENTS

(72) Inventors: **Jonggil Pyo**, Seoul (KR); **Jaeyong Kim**, Seoul (KR); **Kwaneun Jin**, Seoul (KR)

D607,916	S	*	1/2010	Orion	D16/241
D622,322	S	*	8/2010	Hussain	D20/42
D808,668	S	*	1/2018	Tsuchiyama	D6/332
10,410,549	B1	*	9/2019	Kim	G06F 1/1601
10,534,402	B1	*	1/2020	Kim	H05K 5/0217
D875,698	S	*	2/2020	Kang	D14/126
D887,379	S	*	6/2020	Cha	D14/126
D896,193	S	*	9/2020	Cha	D14/126
D901,409	S	*	11/2020	Kim	D14/126
D901,410	S	*	11/2020	Kim	D14/126
D901,411	S	*	11/2020	Kim	D14/126
D915,316	S	*	4/2021	Cha	D14/126
2005/0185273	A1	*	8/2005	Lee	G03B 21/56 359/461

(73) Assignee: **LG ELECTRONICS INC.**, Seoul (KR)

(**) Term: **15 Years**

(21) Appl. No.: **29/730,801**

(22) Filed: **Apr. 8, 2020**

(30) **Foreign Application Priority Data**

Nov. 14, 2019 (KR) 30-2019-0054431

(51) **LOC (13) Cl.** **14-03**

(52) **U.S. Cl.**
USPC **D14/126**

(58) **Field of Classification Search**

USPC D14/125-138, 138 AD, 138 G, 138 R, D14/204, 239, 248, 314-316, 322, 326, D14/334-336, 339, 340, 341, 371, D14/373-377, 448, 450; D6/300, 308, D6/310, 314, 320, 332, 553, 642-643, D6/650.1, 653.15, 654.15, 657, 661, 675; D16/229, 235, 241; D21/324, 329, 332, D21/515; D20/42

CPC G03B 21/58; G03B 21/56; G06F 1/16; G06F 1/1601; G06F 1/1637; G06F 1/1605; G06F 1/162; G06F 1/1652; G09F 9/301; H04N 5/64; H05K 5/0204; H05K 5/0017; H05K 5/0217

See application file for complete search history.

* cited by examiner

Primary Examiner — Ramzi Almatrahi

Assistant Examiner — Charles Cunningham

(74) *Attorney, Agent, or Firm* — Birch, Stewart, Kolasch & Birch, LLP

(57) **CLAIM**

We claim the ornamental design for a rollable television receiver, as shown and described.

DESCRIPTION

FIG. 1 is a front perspective view of a rollable television receiver showing the new design;
 FIG. 2 is a front elevation view thereof;
 FIG. 3 is a rear elevation view thereof;
 FIG. 4 is a left-side elevation view thereof;
 FIG. 5 is a right-side elevation view thereof;
 FIG. 6 is a top plan view thereof;
 FIG. 7 is a bottom plan view thereof;
 FIG. 8 is a rear perspective view thereof; and,
 FIG. 9 is an enlarged view of portion 9 shown in FIG. 1. The broken lines encircling an enlargement portion of the design form no part of the claimed design.

1 Claim, 9 Drawing Sheets

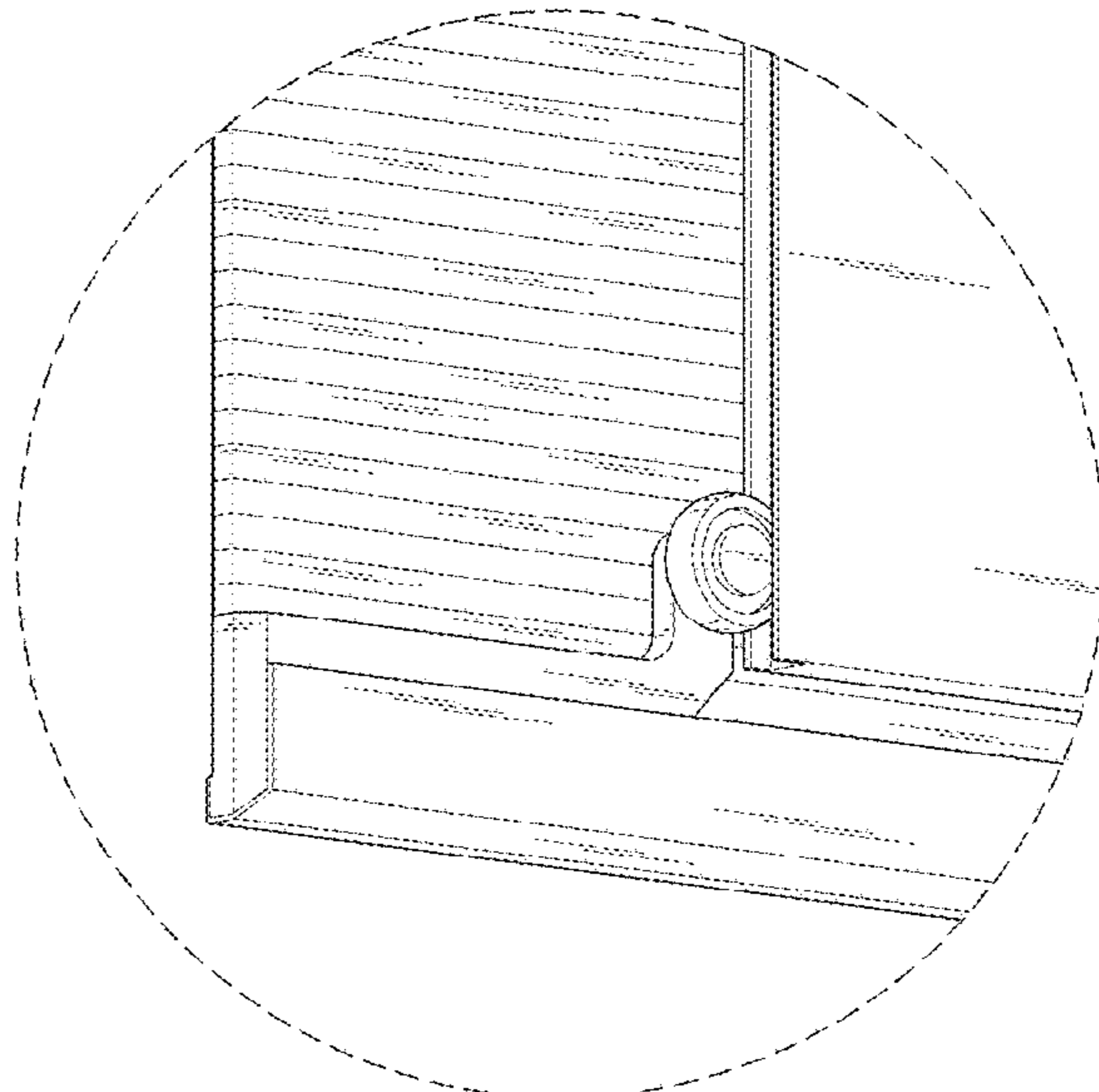
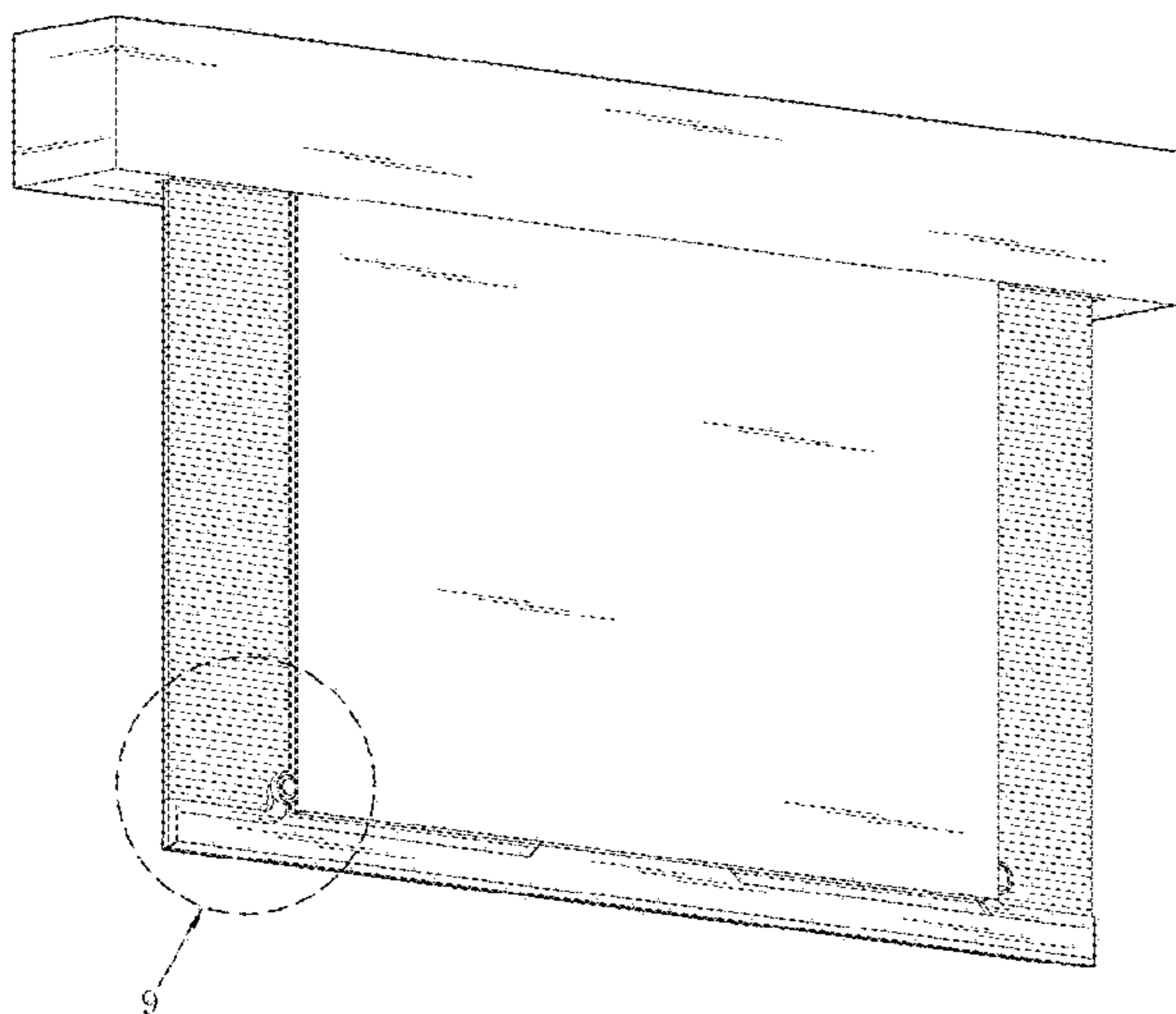

FIG. 1

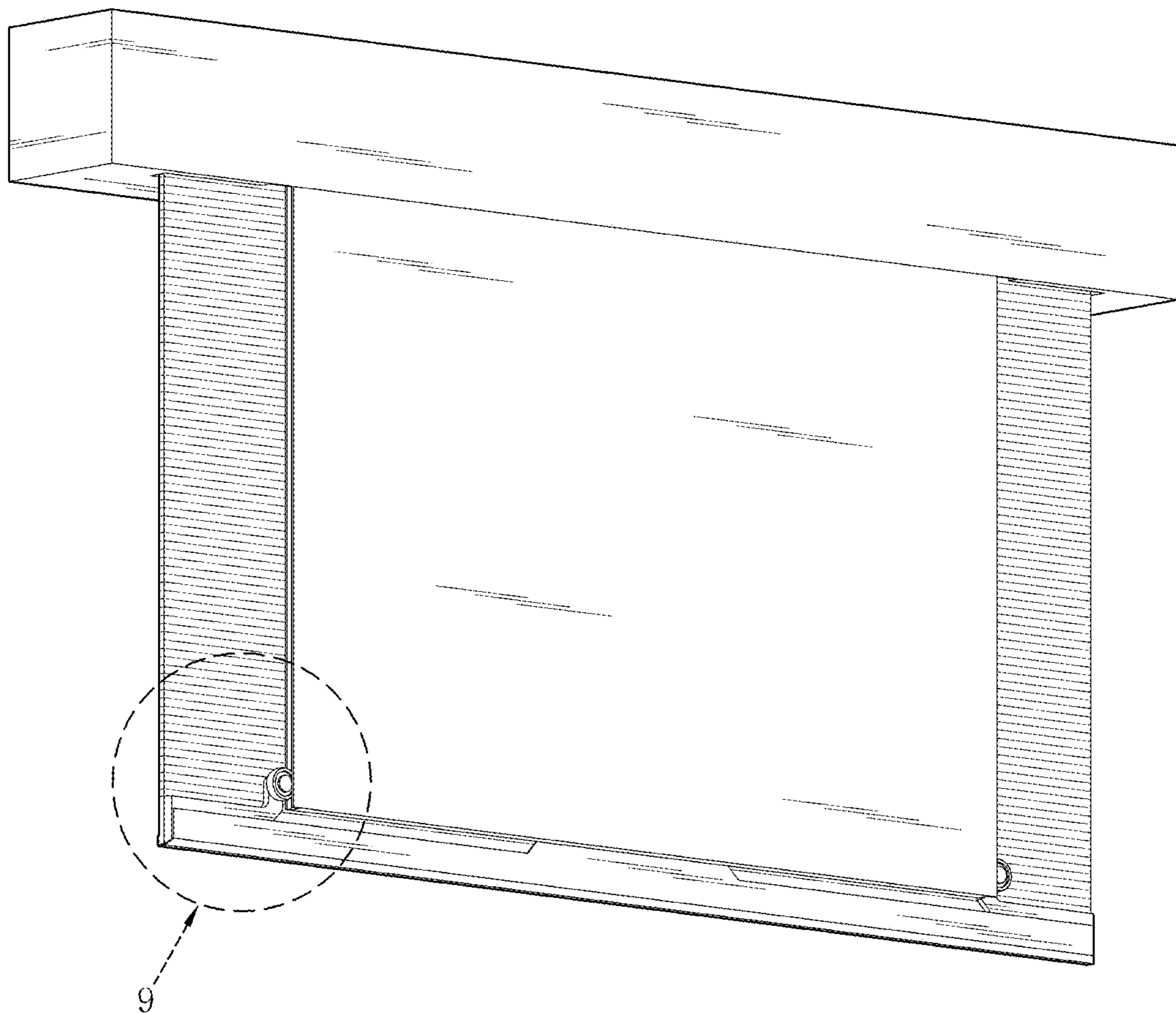

FIG. 2

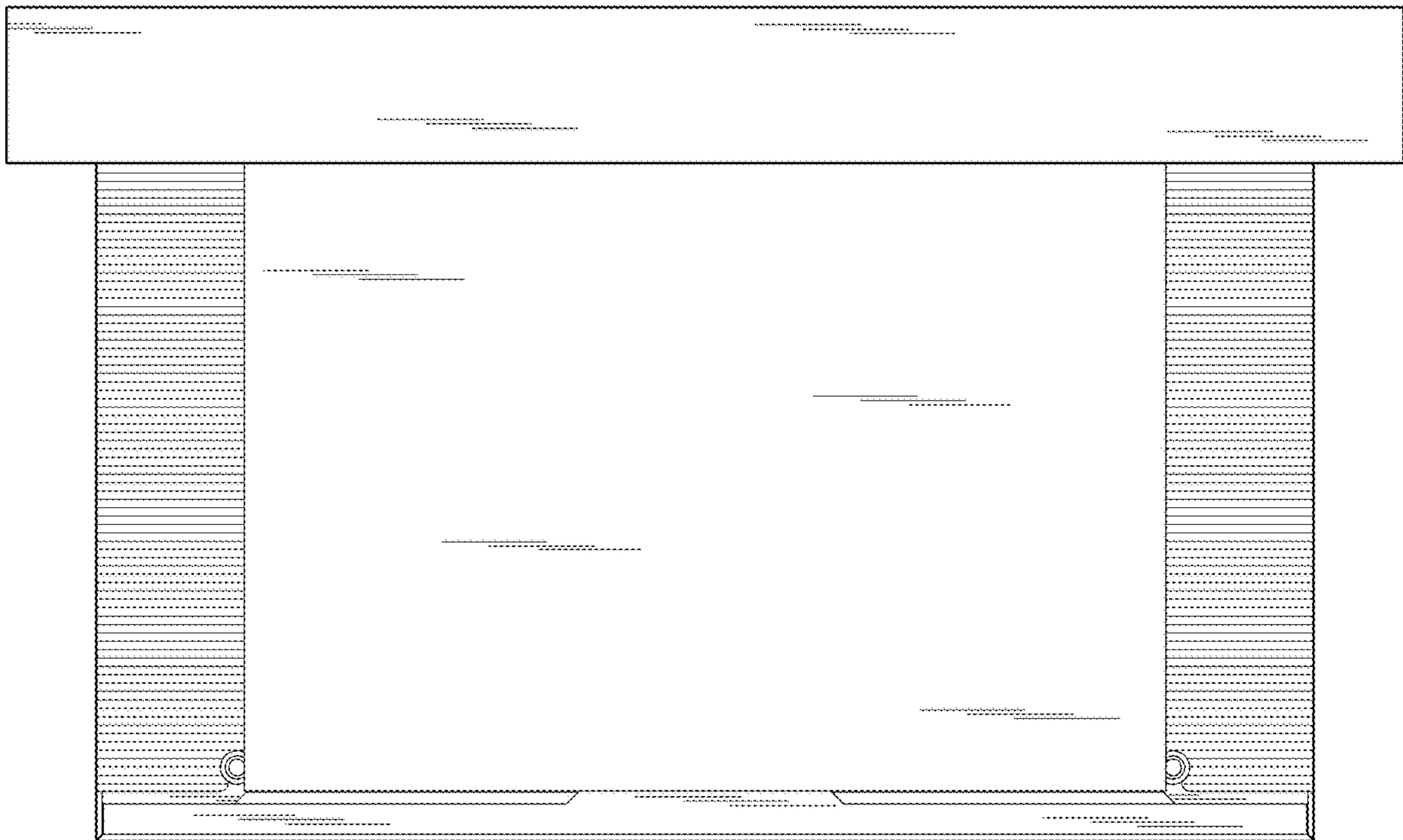

FIG. 3

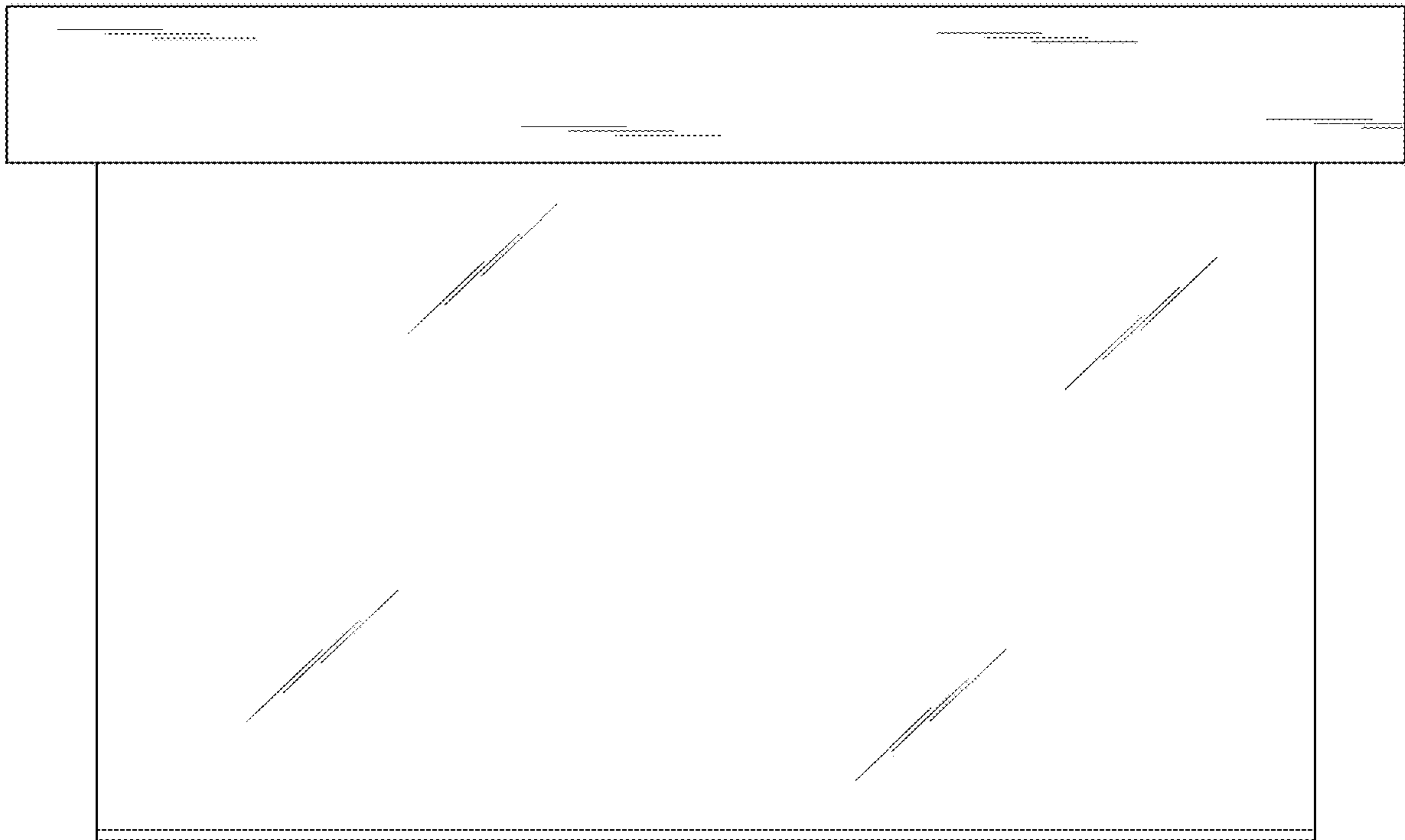

FIG. 4

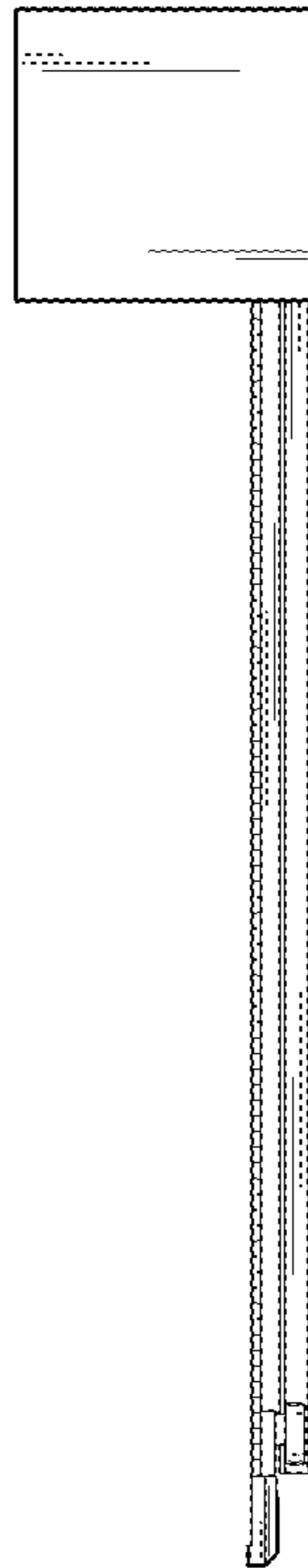

FIG. 5

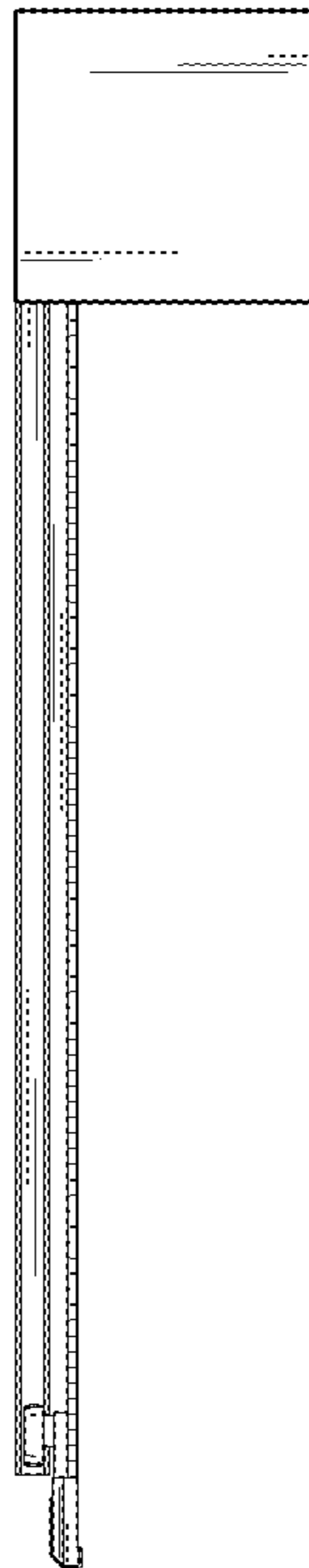

FIG. 6

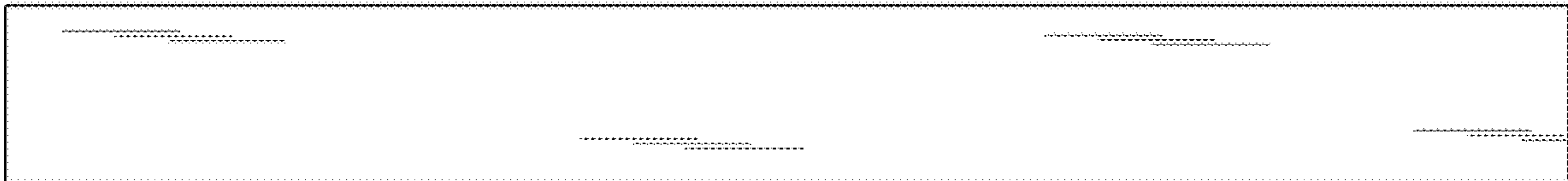

FIG. 7

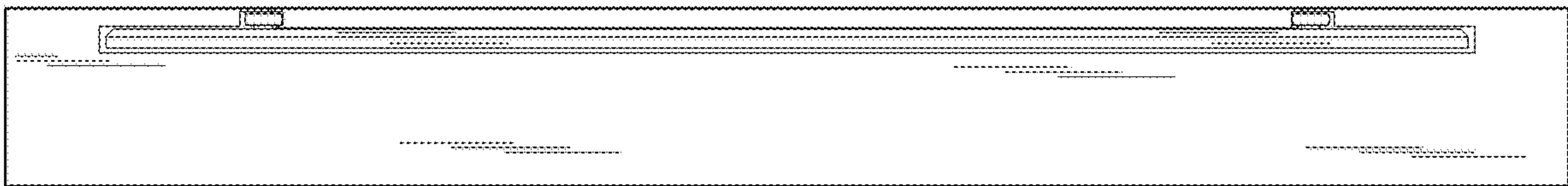

FIG. 8

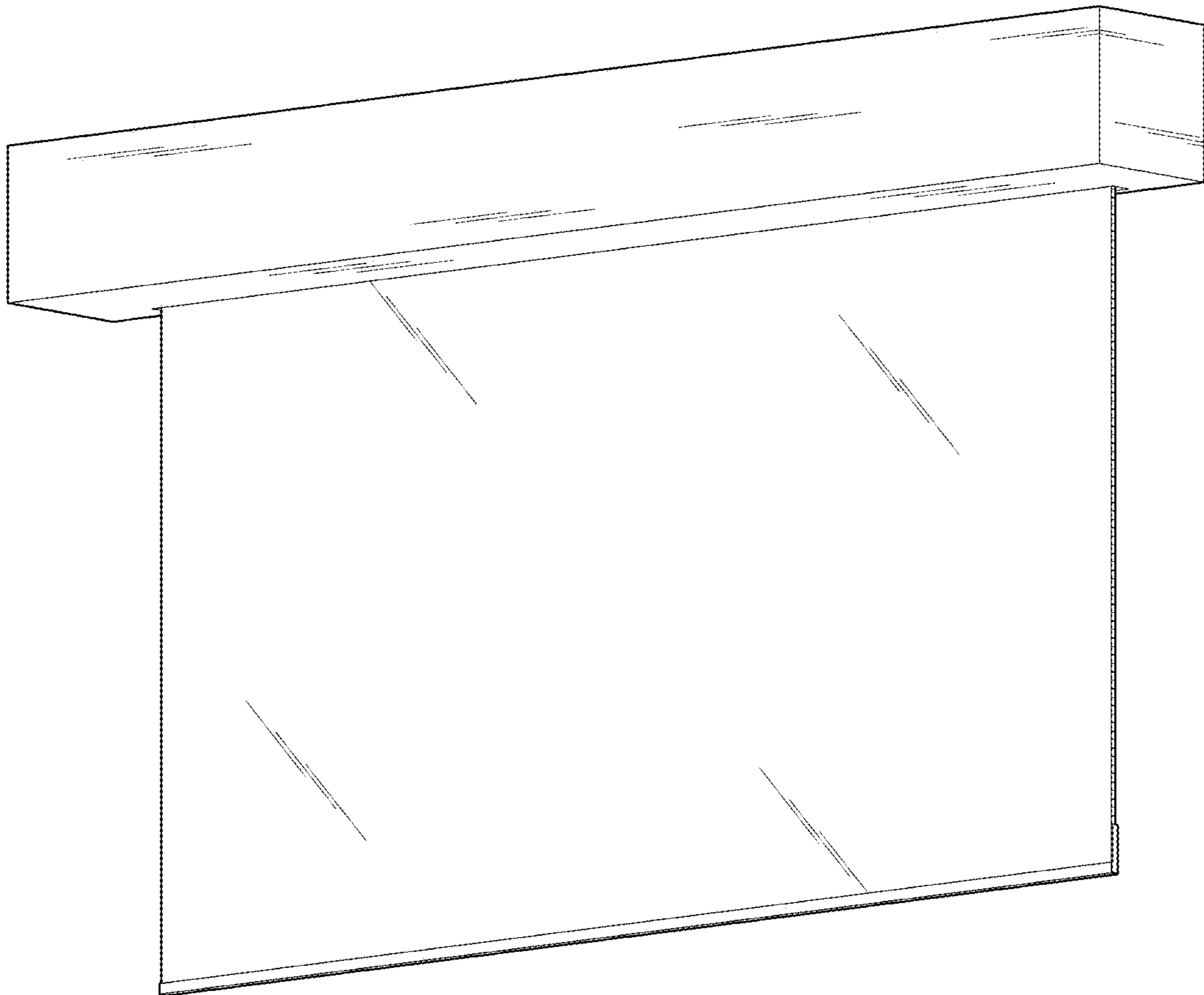

FIG. 9

