



US00D934806S

(12) **United States Design Patent** (10) **Patent No.:** **US D934,806 S**
Khadse et al. (45) **Date of Patent:** **** Nov. 2, 2021**

(54) **LINEAR LED SERIES EMERGENCY BATTERY BACKUP LUMINAIRE**

OTHER PUBLICATIONS

(71) Applicant: **Appleton Grp LLC**, Rosemont, IL (US)

“Explosion Proof Low Profile Linear LED Light,” Aug. 15, 2013, amazon.com, site visited Mar. 3, 2021, URL: https://www.amazon.com/Explosion-Proof-Profile-Linear-Light/dp/B00EKVSXWM (Year: 2015).*

(72) Inventors: **Shriprasad V. Khadse**, Pin (IN); **Santosh K. Patil**, Pune (IN); **Timothy E. Graff**, Arlington Heights, IL (US); **Sumit Kumar**, Pune (IN); **Harish P. Kulkarni**, Pune (IN)

(Continued)

(73) Assignee: **Appleton Grp LLC**, Rosemont, IL (US)

Primary Examiner — Eric L Goodman

Assistant Examiner — Sarah L Smith

(74) *Attorney, Agent, or Firm* — McDonnell Boehnen Hulbert & Berhoff LLP

(**) Term: **15 Years**

(57) **CLAIM**

(21) Appl. No.: **29/717,784**

The ornamental design for a linear LED series emergency battery backup luminaire, as shown and described.

(22) Filed: **Dec. 19, 2019**

(30) **Foreign Application Priority Data**

DESCRIPTION

Jun. 19, 2019 (IN) 318900-001

(51) **LOC (13) Cl.** **13-02**

(52) **U.S. Cl.**
USPC **D13/121; D26/72; D26/76**

(58) **Field of Classification Search**
USPC D26/3, 24–27, 37–42, 46, 50, 60–69, 72, D26/74–78, 80–86, 88, 89, 93, 104, 106,
(Continued)

FIG. 1 is a perspective top view of a linear LED series emergency battery backup luminaire having the inventive design;

FIG. 2 is a front view of the linear LED series emergency battery backup luminaire shown in FIG. 1;

FIG. 3 is a rear view of the linear LED series emergency battery backup luminaire shown in FIG. 1;

FIG. 4 is a left side view of the linear LED series emergency battery backup luminaire shown in FIG. 1;

FIG. 5 is a right side view of the linear LED series emergency battery backup luminaire shown in FIG. 1;

FIG. 6 is a top view of the the linear LED series emergency battery backup luminaire shown in FIG. 1; and,

FIG. 7 is a bottom view of the linear LED series emergency battery backup luminaire shown in FIG. 1.

The broken line disclosure represents portions of the linear LED series emergency battery backup luminaire which forms no part of the claimed design.

(56) **References Cited**

U.S. PATENT DOCUMENTS

4,435,744 A * 3/1984 Russo F21S 8/031
362/219

D760,418 S * 6/2016 Muchandi D26/76
(Continued)

FOREIGN PATENT DOCUMENTS

CN 303567480 * 1/2016
CN 304659127 * 6/2018

(Continued)

1 Claim, 4 Drawing Sheets

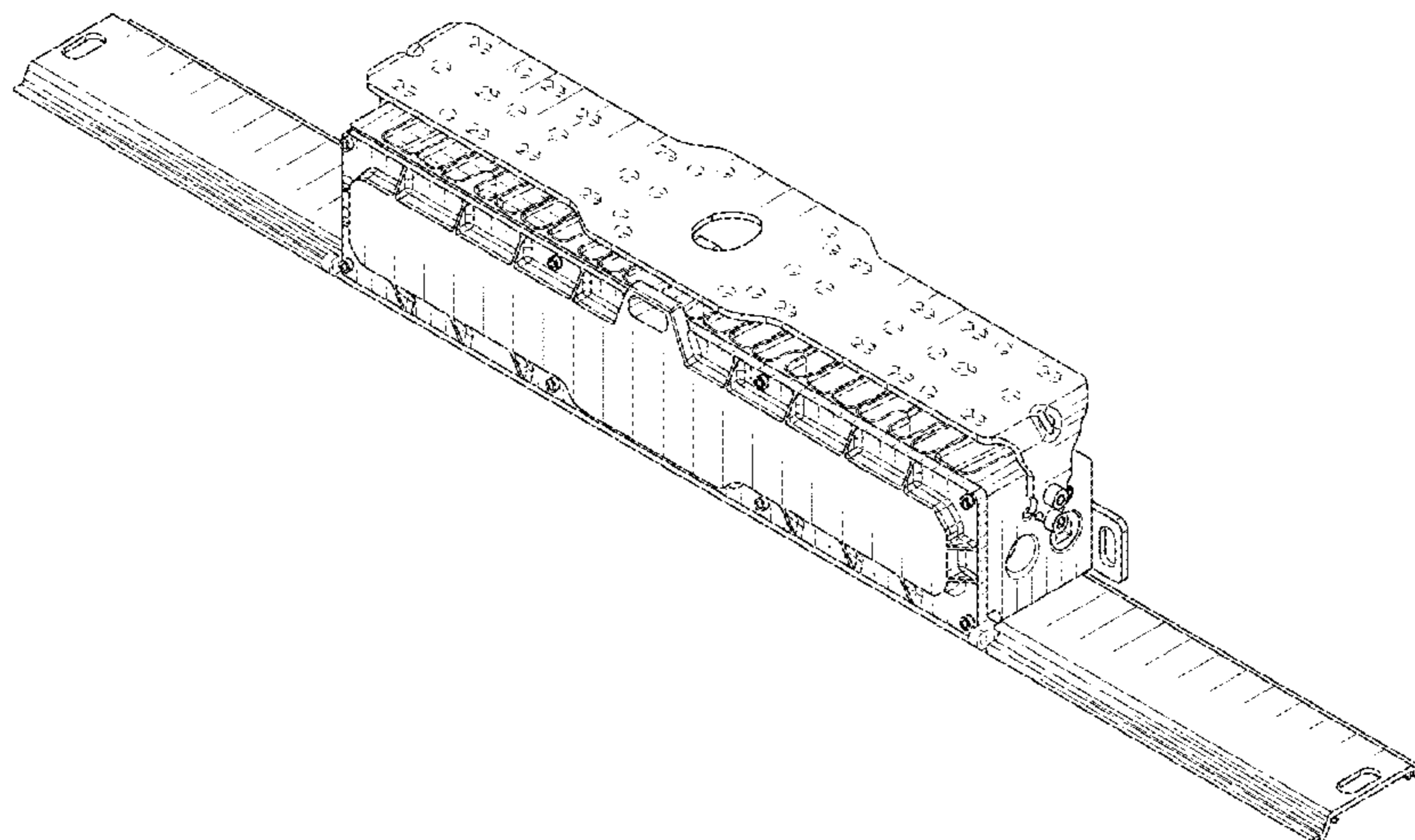

(58) **Field of Classification Search**

USPC D26/108, 109, 110, 113, 118–120,
 D26/122–124, 130, 133–137; D13/121
 CPC ... F21Y 2115/10; F21Y 2103/00; F21S 8/061;
 F21S 8/043; F21S 8/06; F21S 8/026;
 F21S 8/04; F21S 4/28; F21V 23/008;
 F21V 29/76

See application file for complete search history.

(56) **References Cited**

U.S. PATENT DOCUMENTS

D817,535 S * 5/2018 Feng F21S 8/043
 D26/76
 D818,626 S * 5/2018 Park F21V 23/009
 D26/76
 D855,862 S * 8/2019 Verfueth F21V 7/0083
 D26/76
 D865,258 S * 10/2019 Honda F21S 8/02
 D26/76
 D872,338 S * 1/2020 Deng D26/76
 D872,923 S * 1/2020 Deng D26/76
 2015/0330595 A1* 11/2015 Grigore F21S 8/02
 362/218
 2016/0356475 A1* 12/2016 Honda F21K 9/27
 2017/0097152 A1* 4/2017 Scribante F21V 7/0083
 2019/0277464 A1* 9/2019 Won G02B 6/0088

2020/0288603 A1* 9/2020 Patil F21V 23/009
 2020/0292142 A1* 9/2020 Kulkarni F21S 8/043
 2020/0292153 A1* 9/2020 Kulkarni F21V 11/183

FOREIGN PATENT DOCUMENTS

CN 304659128 * 6/2018
 EM 002593384-0002 * 1/2015 F21S 8/04
 EM 006648382-0001 * 10/2019
 EP 3076068 B1 * 10/2017 F21S 8/04

OTHER PUBLICATIONS

“NJZ Lighting Launches UL844-Class I,” Mar. 31, 2017, ledsmagazine.com, site visited Nov. 20, 2020, URL: <https://www.ledsmagazine.com/directory/press-release/14057151/njz-lighting-technology-co-ltd-njz-lighting-launches-ul844class-i-div-2-ranger-series-hazloc-led-luminaires> (Year: 2017).*

“Dialight Safesite Linear LED Explosion Proof Light,” Oct. 10, 2018, amazon.com, site visited Mar. 3, 2021, URL: <https://www.amazon.com/Dialight-Safesite-Linear-Explosion-lumens/dp/B07JBBTSGF> (Year: 2018).*

“Intrinsically Safe LED Lighting Horner Linear,” Feb. 22, 2019, youtube.com, site visited Mar. 12, 2021, URL: <https://www.youtube.com/watch?v=c9GZhOatHfc> (Year: 2019).*

* cited by examiner

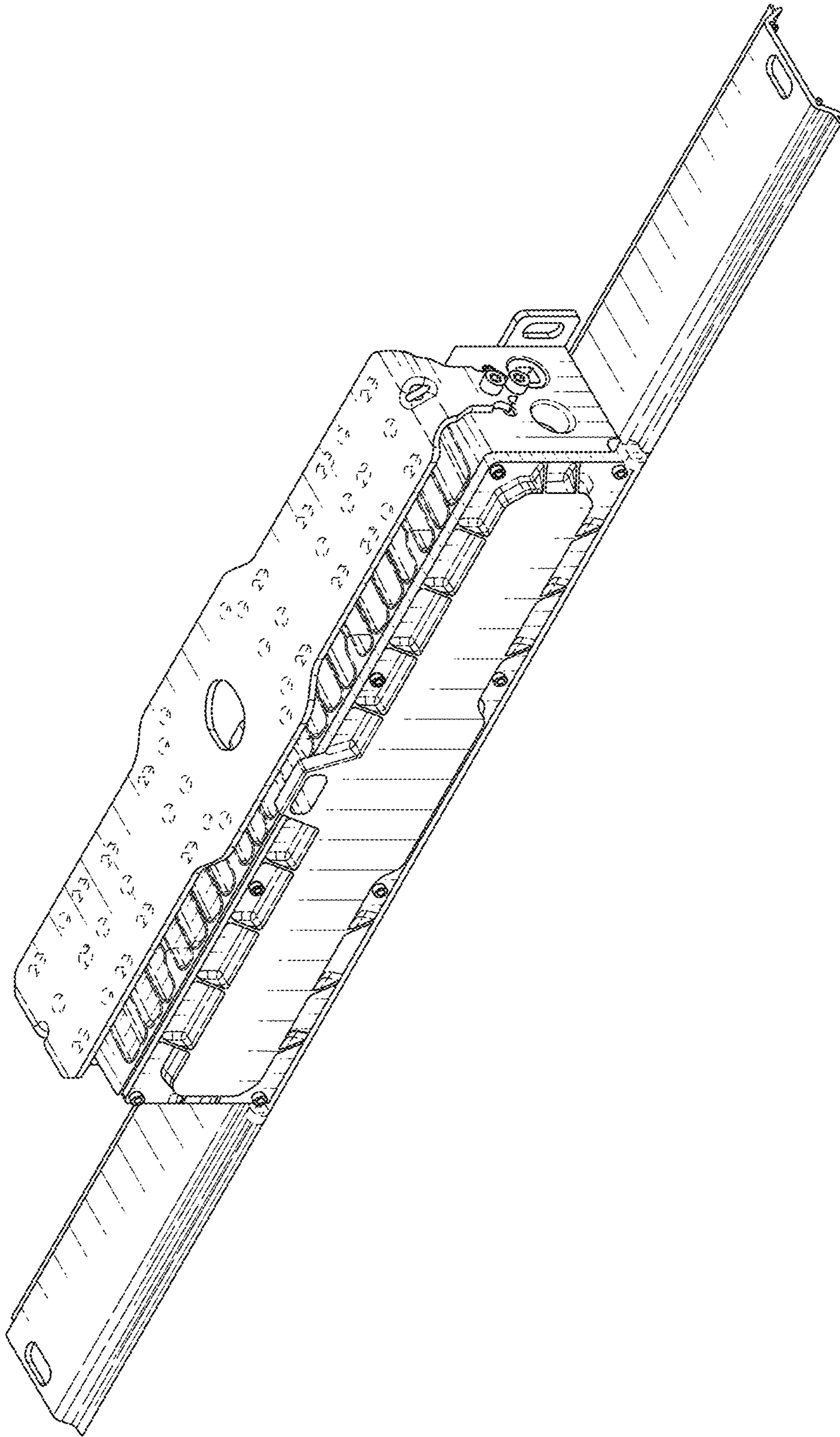

FIG. 1

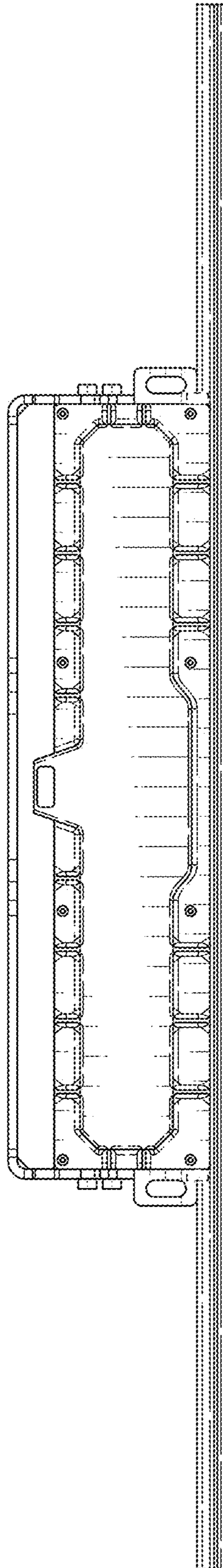

FIG. 2

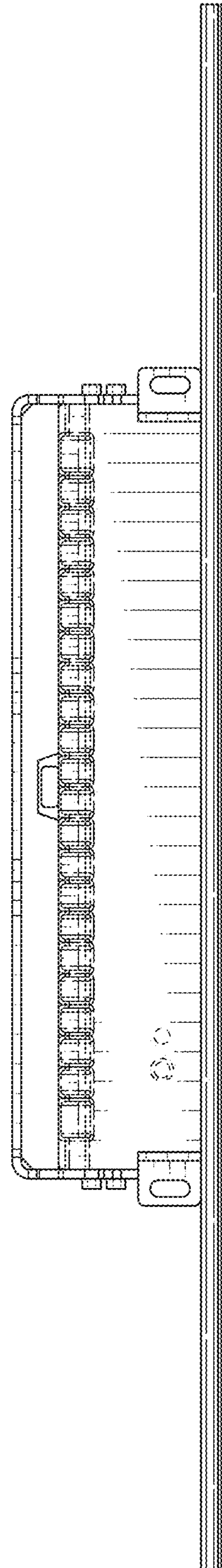

FIG. 3

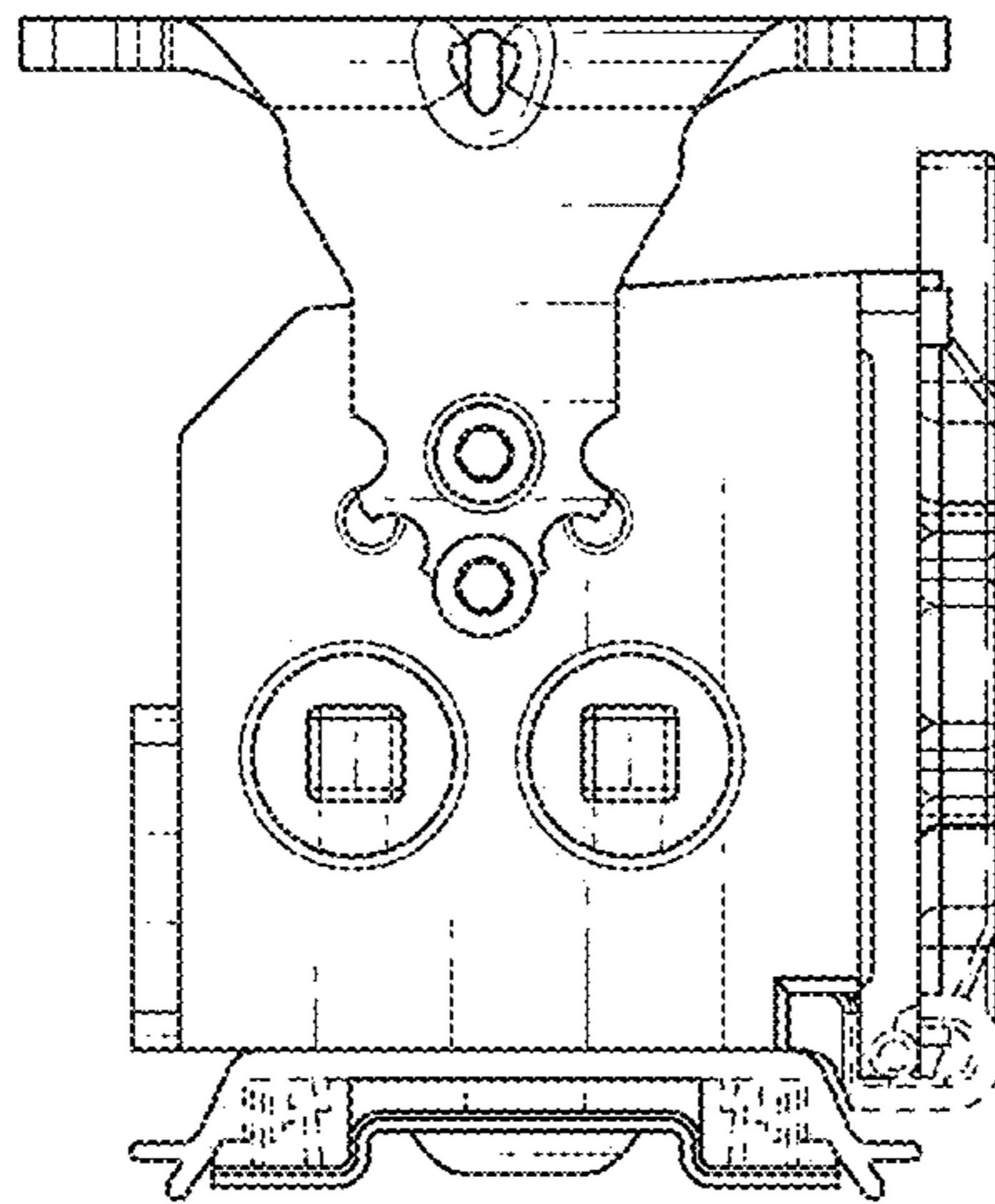

FIG. 4

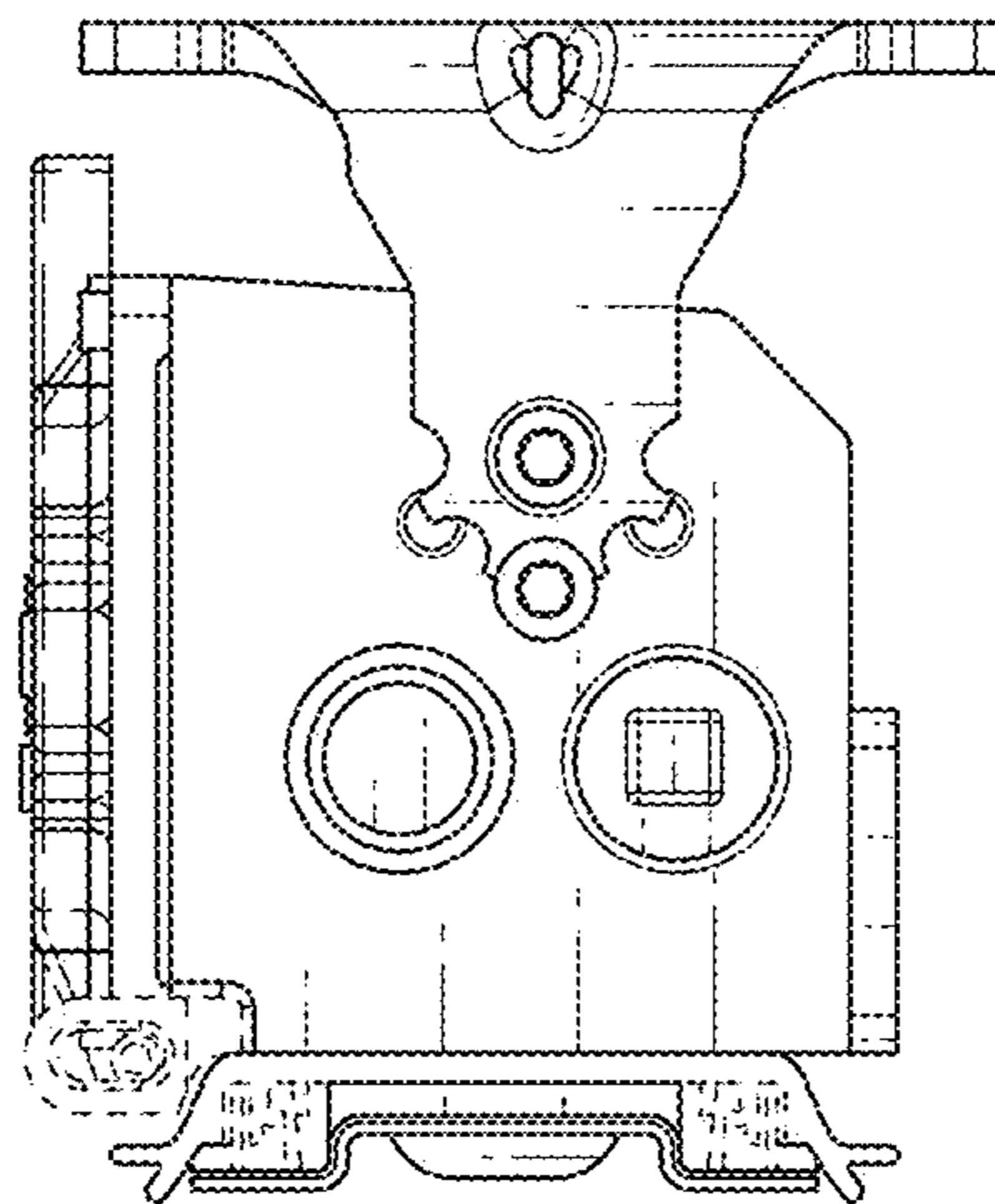

FIG. 5

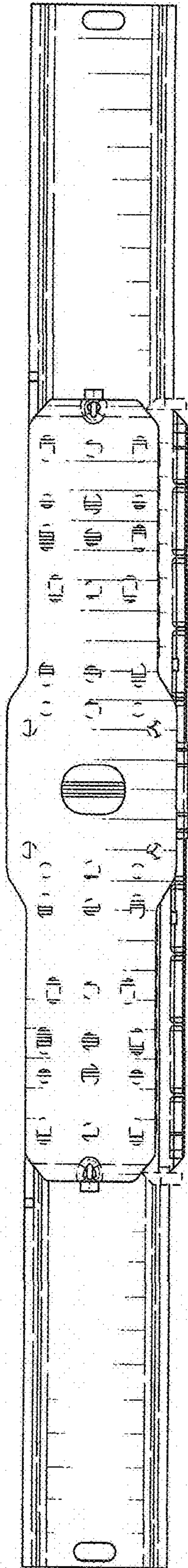

FIG. 6

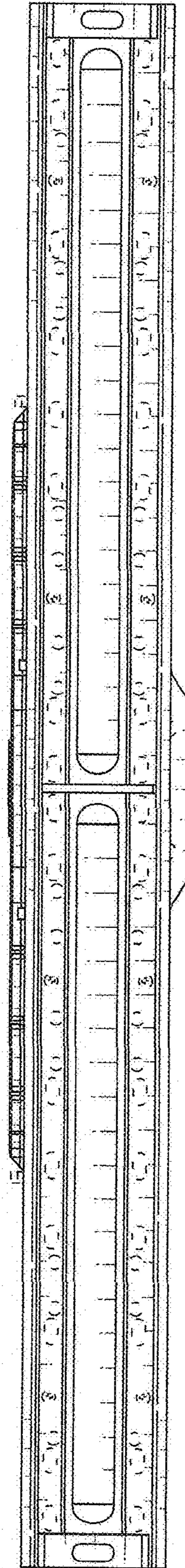

FIG. 7