



US00D934685S

(12) **United States Design Patent**
Jungemann et al.

(10) **Patent No.:** **US D934,685 S**

(45) **Date of Patent:** **** Nov. 2, 2021**

(54) **PACKING PAPER**

(71) Applicant: **Sprick GmbH Bielefelder Papier-und Wellpappenwerke & Co.**, Bielefeld (DE)

(72) Inventors: **Birgit Jungemann**, Bielefeld (DE); **Nicole Gaede**, Bielefeld (DE)

(73) Assignee: **Sprick GmbH Bielefelder Papier-und Wellpappenwerke & Co.**, Bielefeld (DE)

(**) Term: **15 Years**

(21) Appl. No.: **35/508,639**

(22) Filed: **Mar. 25, 2019**

(80) **Hague Agreement Data**

Int. Filing Date: **Mar. 25, 2019**

Int. Reg. No.: **DM/205883**

Int. Reg. Date: **Mar. 25, 2019**

Int. Reg. Pub. Date: **Feb. 14, 2020**

(30) **Foreign Application Priority Data**

Sep. 24, 2018 (EM) 005656105

(51) **LOC (13) Cl.** **09-07**

(52) **U.S. Cl.**
USPC **D9/456; D5/99; D9/499**

(58) **Field of Classification Search**

USPC D9/434, 499, 456, 457; D3/23, 24, 26; D5/7, 32, 37, 99; D19/1, 100; D18/99; D99/99

(Continued)

(56) **References Cited**

U.S. PATENT DOCUMENTS

631,141 A * 8/1899 Weinberg B65H 35/0006
225/80

1,007,552 A * 10/1911 Fuller 242/146

(Continued)

OTHER PUBLICATIONS

Facebook. Papier Sprick. Sep. 25, 2018. <https://www.facebook.com/papiersprick/photos/guten-morgen-heute-zeigen-wir-euch-noch-eine-neuheit-auf-der-fachpack-in-n%C3%BCmber/1833402026714181/> (Year: 2018).*

(Continued)

Primary Examiner — Darcey E Gottschalk

(74) *Attorney, Agent, or Firm* — Schiff Hardin LLP

(57) **CLAIM**

The ornamental design for a packing paper, as shown and described.

DESCRIPTION

The patent or application file contains at least one drawing executed in color. Copies of this patent or patent application publication with color drawing(s) will be provided by the Office upon request and payment of the necessary fee.

1.1: Perspective

1.2: Top

2.1: Perspective

2.2: Top

3.1: Perspective

3.2: Top

4.1: Perspective

4.2: Top

5.1: Perspective

5.2: Top

6.1: Perspective

6.2: Top

7.1: Perspective

7.2: Top

8.1: Perspective

8.2: Top

10.1: Perspective

10.2: Top

11.1: Perspective

11.2: Top

12.1: Perspective

12.2: Top

(Continued)

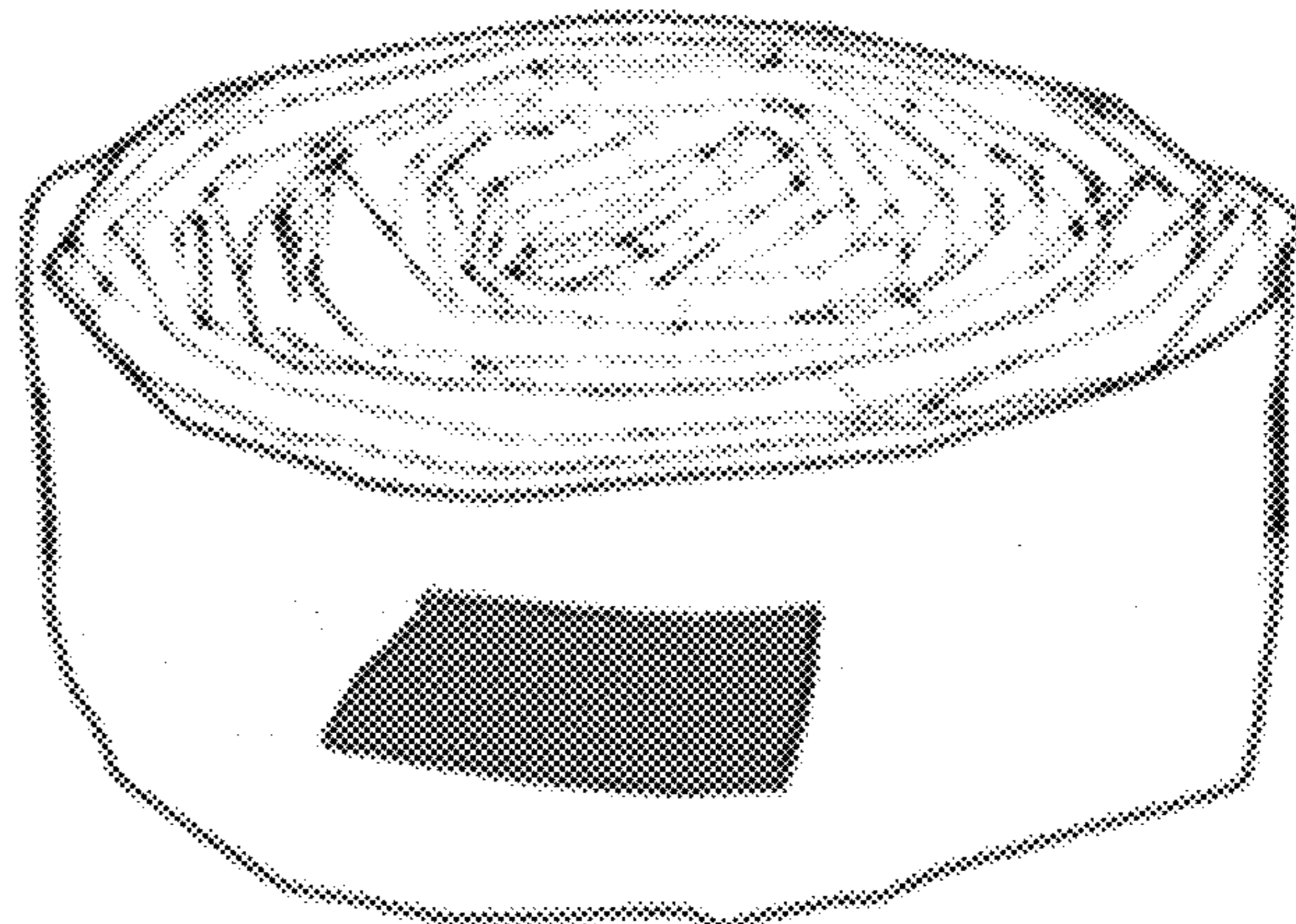
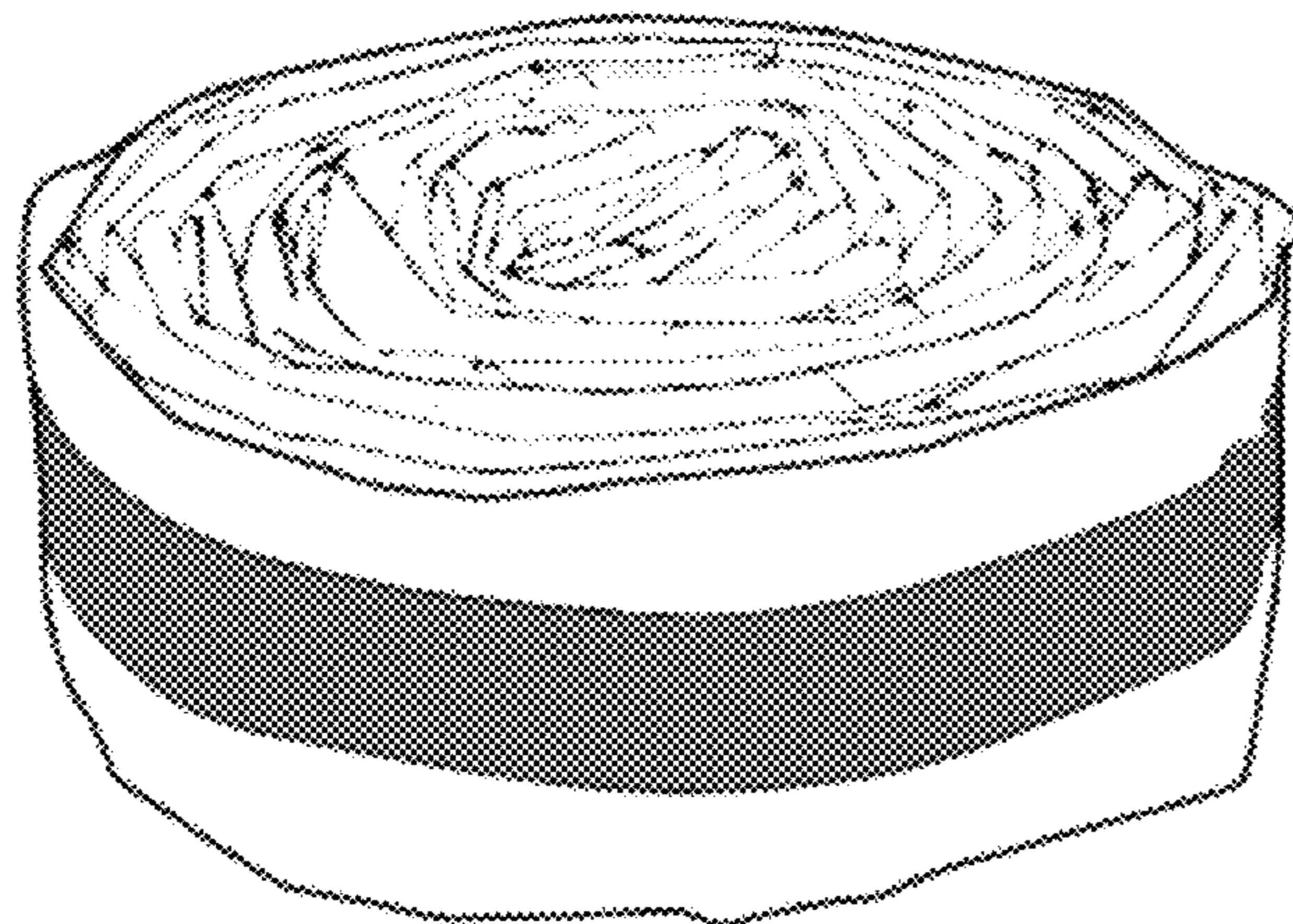

13.1: Perspective	2,512,959 A *	6/1950	Mintel	A47G 27/0256
13.2: Top					112/412
15.1: Perspective	D205,056 S *	6/1966	Emmet	D2/865
15.2: Top	3,336,618 A *	8/1967	Day	H01L 21/00
16.1: Perspective					15/229.11
16.2: Top	4,007,835 A *	2/1977	Klothe	A41D 27/06
17.1: Perspective					206/411
17.2: Top	D281,482 S *	11/1985	Suzuki	D3/24
18.1: Perspective	4,919,980 A *	4/1990	Pirkey	D04D 7/10
18.2: Top					223/46
20.1: Perspective	D342,693 S *	12/1993	Kozma	D11/117
20.2: Top	D382,800 S *	8/1997	Dedering	D24/199
21.1: Perspective	D396,958 S *	8/1998	Welch	D5/4
21.2: Top	D573,466 S *	7/2008	White	D9/456
22.1: Perspective	D617,205 S *	6/2010	Hernandez	D9/661
22.2: Top	D880,875 S *	4/2020	Ellis	D5/99
23.1: Perspective	2007/0039849 A1 *	2/2007	Rodriguez	B65D 5/4262
23.2: Top					206/457
25.1: Perspective	2019/0023521 A1 *	1/2019	Roussel	B65H 75/22
25.2: Top					
26.1: Perspective					
26.2: Top					
27.1: Perspective					
27.2: Top					
28.1: Perspective					
28.2: Top					

**1 Claim, 48 Drawing Sheets
(24 of 48 Drawing Sheet(s) Filed in Color)**

(58) **Field of Classification Search**
 CPC B31F 1/0003; B31F 1/0006; B31F
 2201/0741; B65D 5/5035; B65D 13/04;
 B65D 15/04
 See application file for complete search history.

(56) **References Cited**

U.S. PATENT DOCUMENTS

D96,618 S *	8/1935	Meyer	D3/23
2,257,154 A *	9/1941	Bleyer	A47G 33/08
				428/4

OTHER PUBLICATIONS

Papier Sprick. Wheel. No date specified, <https://www.papier-sprick.de/en/applications-products/wheel/> (Year: 0).*

iStock Photo. Roll of brown wrapping paper isolated on a white background stock photo. Oct. 26, 2020. <https://www.istockphoto.com/photo/roll-of-brown-wrapping-paper-isolated-on-a-white-background-gm1282292609-380063994> (Year: 2020).*

Youtube. How To Properly Pack Wine Glasses. Mar. 14, 2017. https://www.youtube.com/watch?v=N_L3lqZ6WBU (Year: 2017).*

Youtube. How To Pack Glassware When Moving Home—Matthew James Removals. Nov. 18, 2014. <https://www.youtube.com/watch?v=rGFvf7fixj0> (Year: 2014).*

U Pack. Packing Paper for Moving. Jan. 26, 2021. <https://www.upack.com/articles/packing-paper-for-moving> (Year: 2021).*

Mulder's Moving & Storage. Can I Wrap With Newspaper? Dec. 16, 2019. <https://muldersmoving.com/can-i-wrap-with-newspaper/> (Year: 2019).*

* cited by examiner

1.1

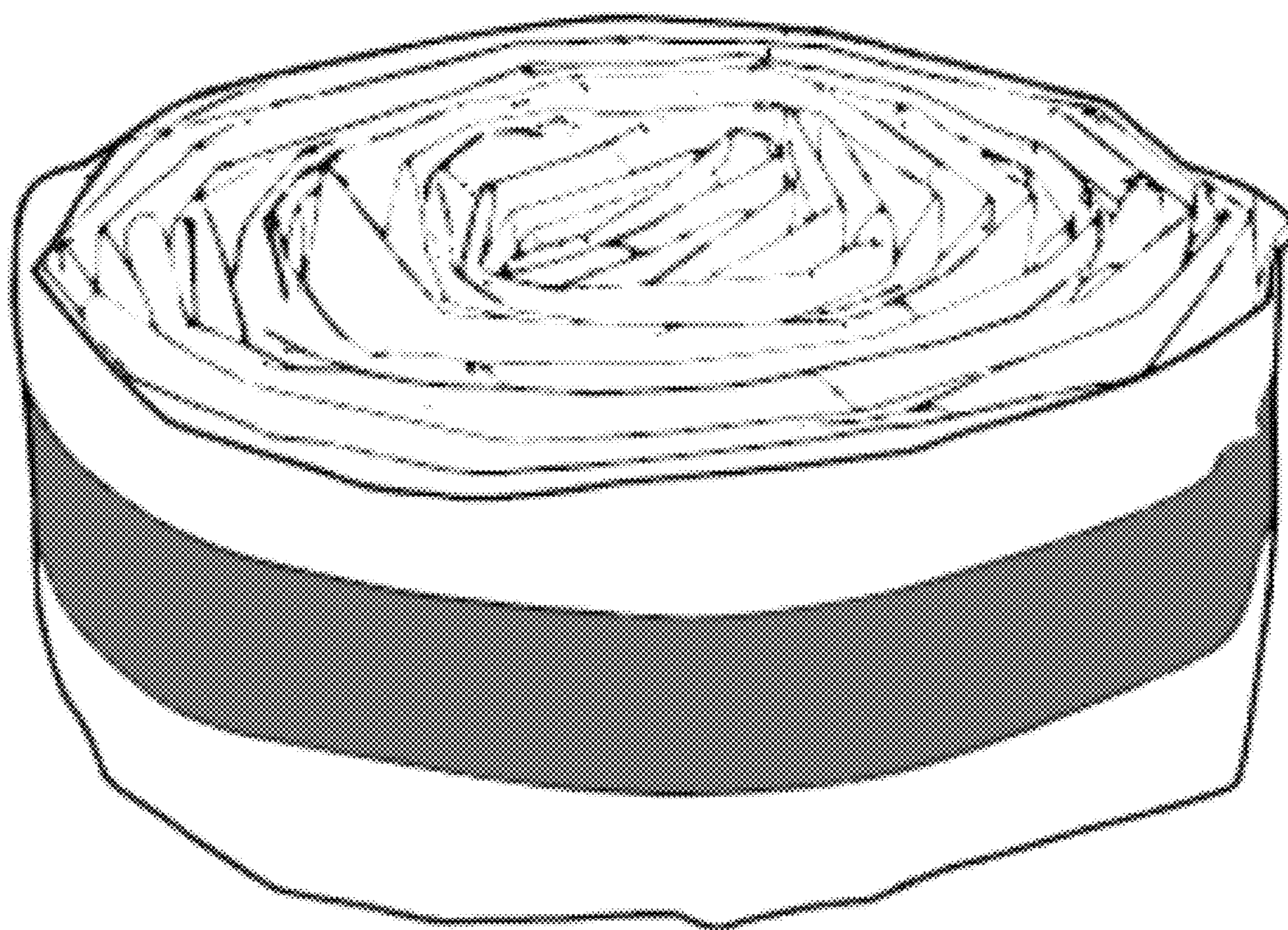

1.2



2.1

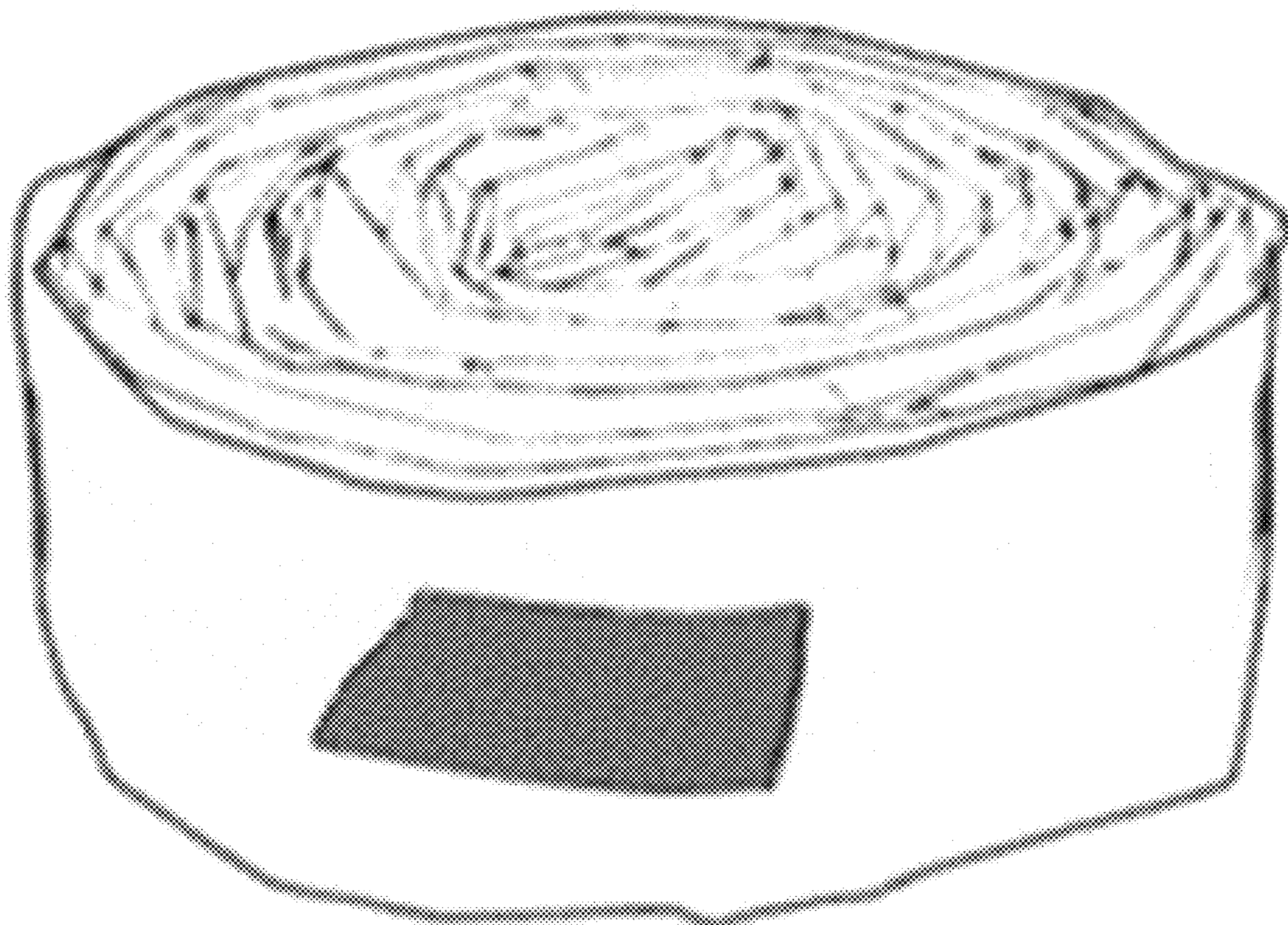

2.2



3.1

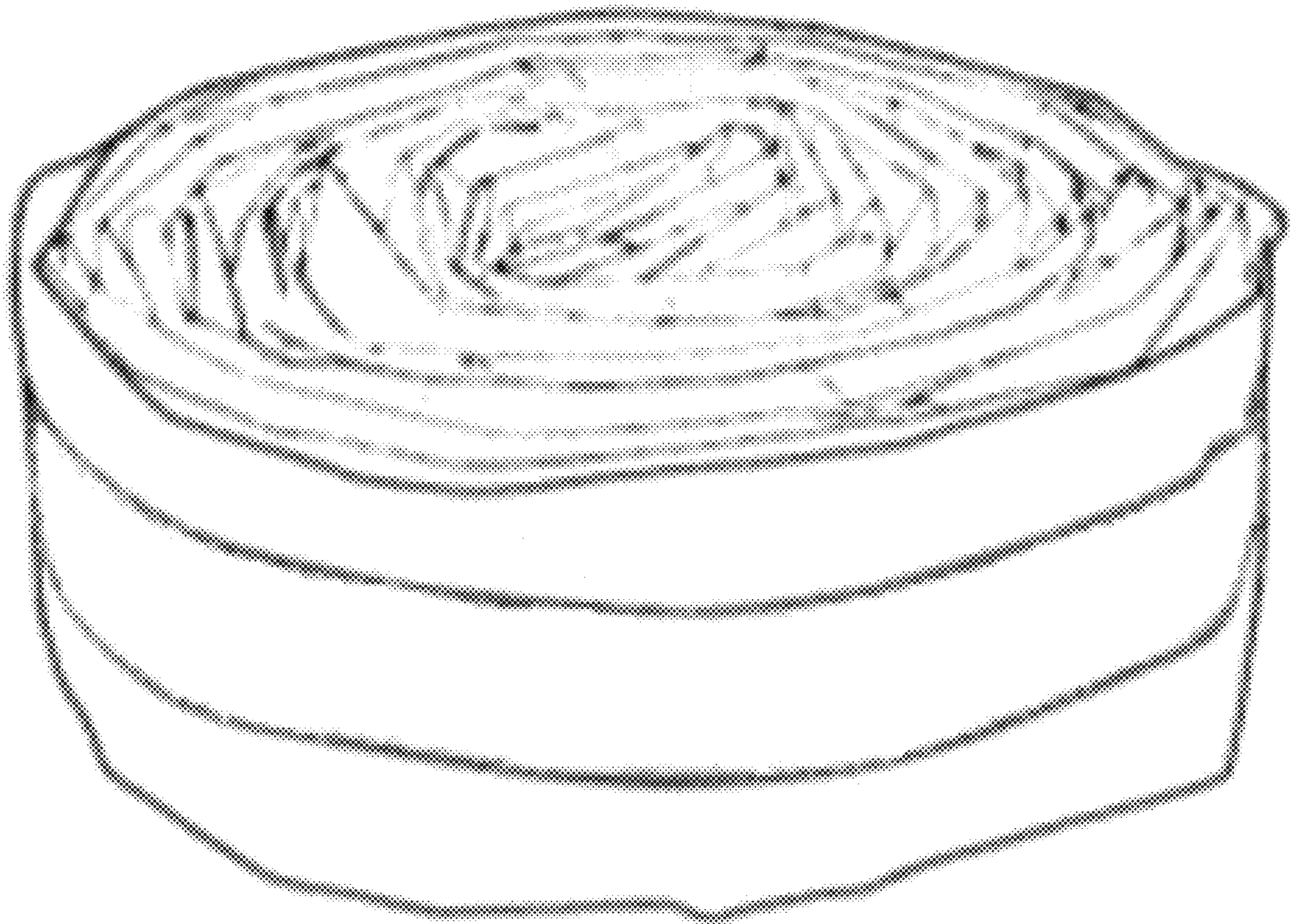

3.2



4.1

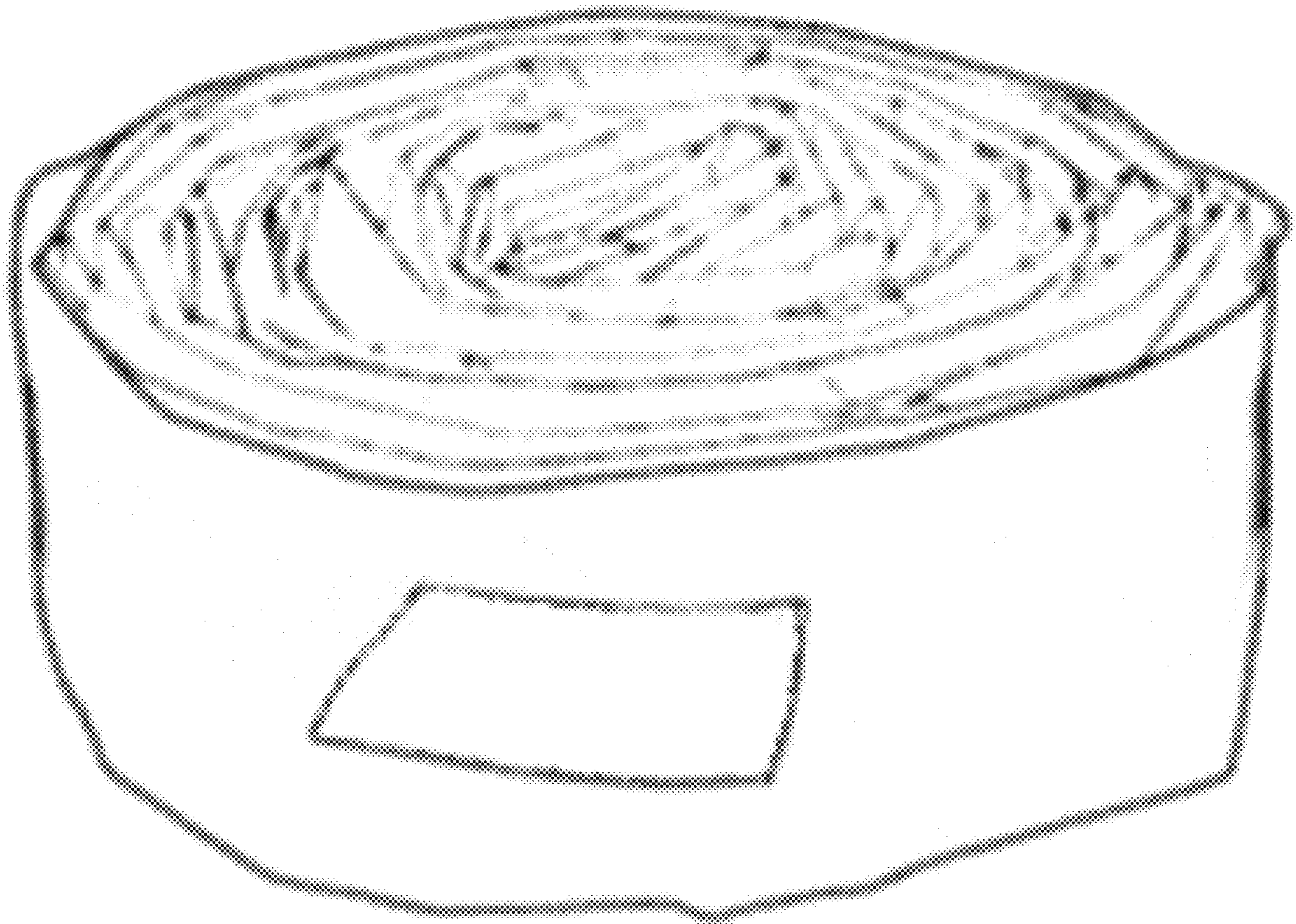

4.2



5.1

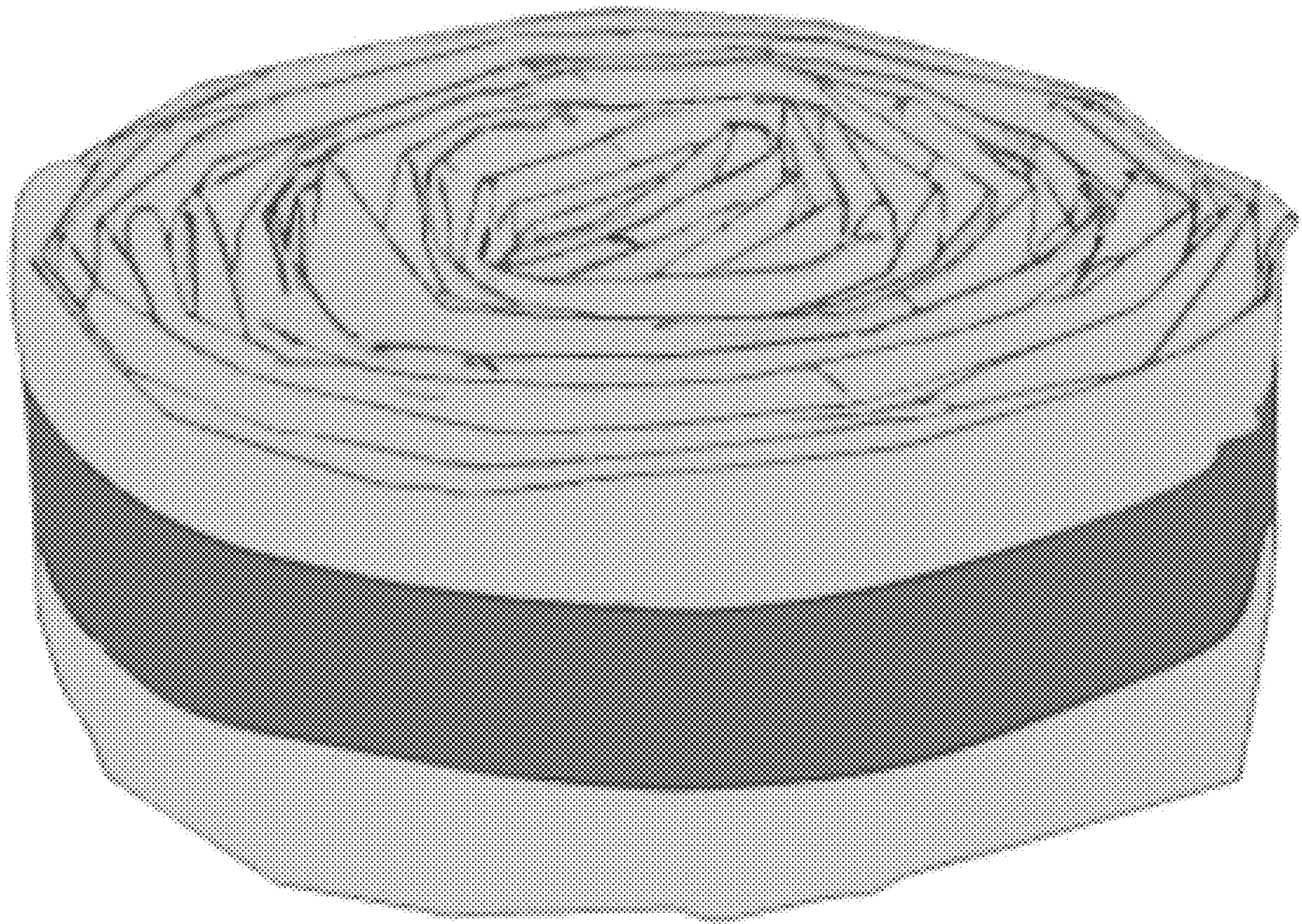

5.2

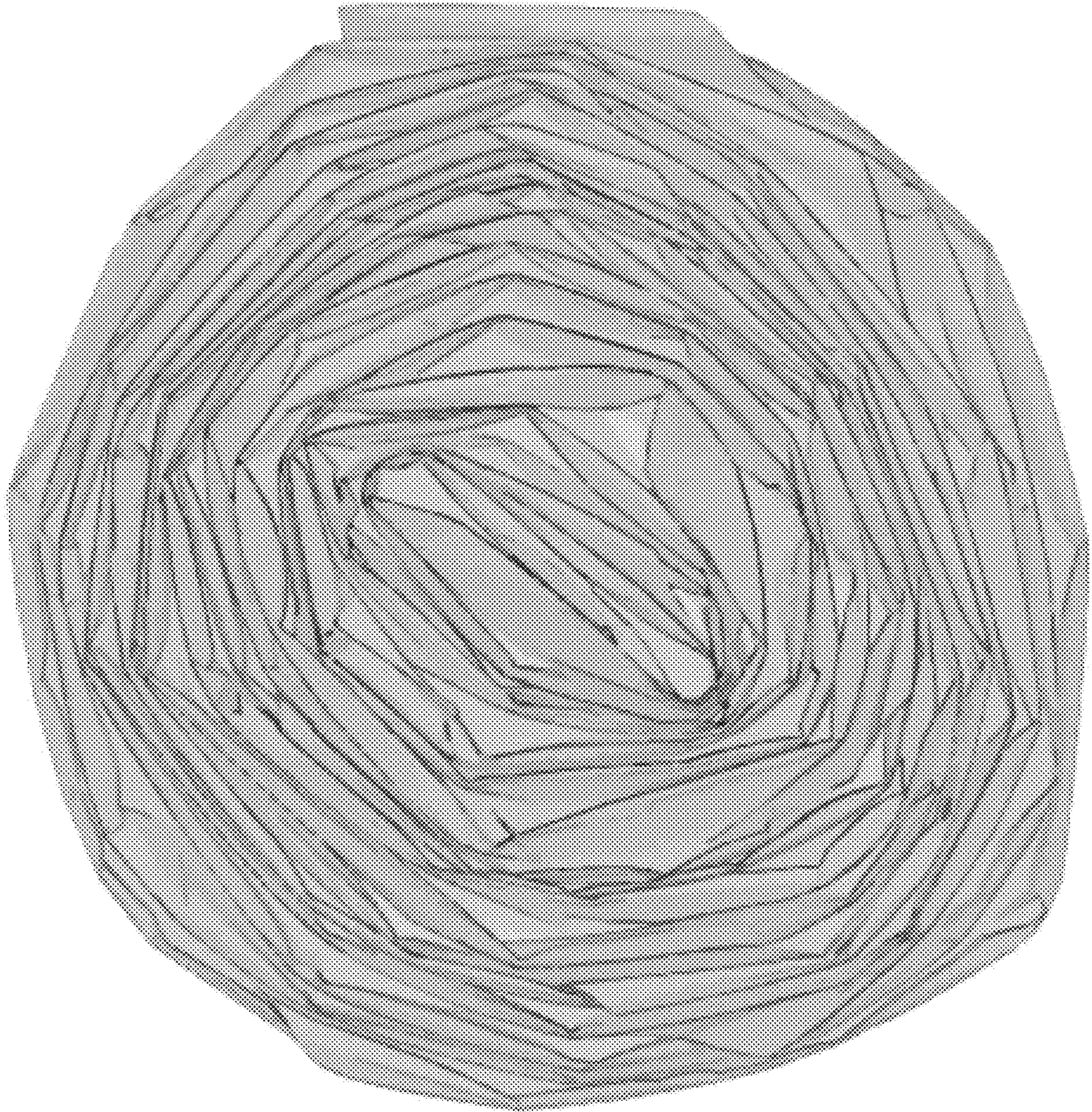

6.1

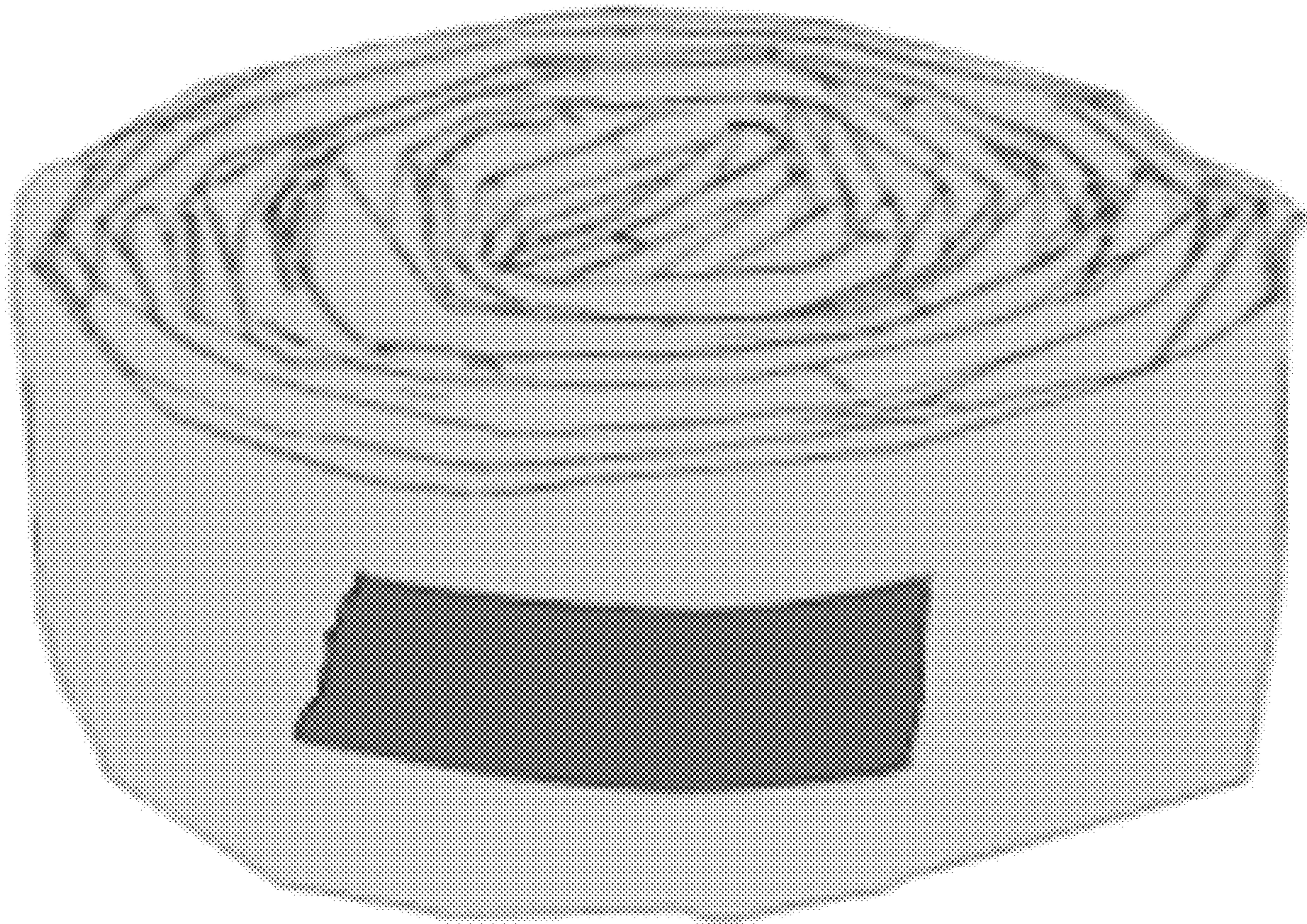

6.2

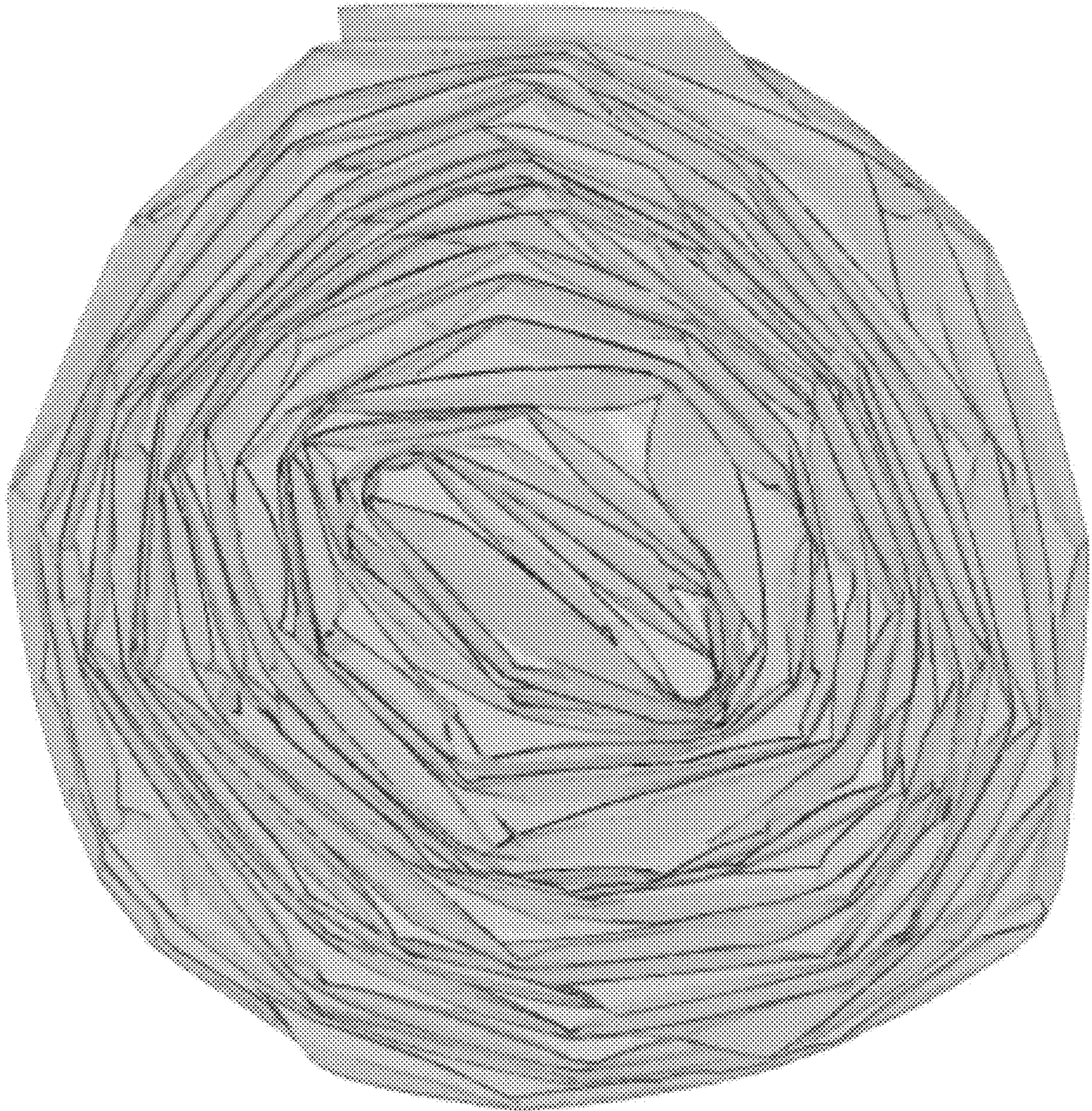

7.1

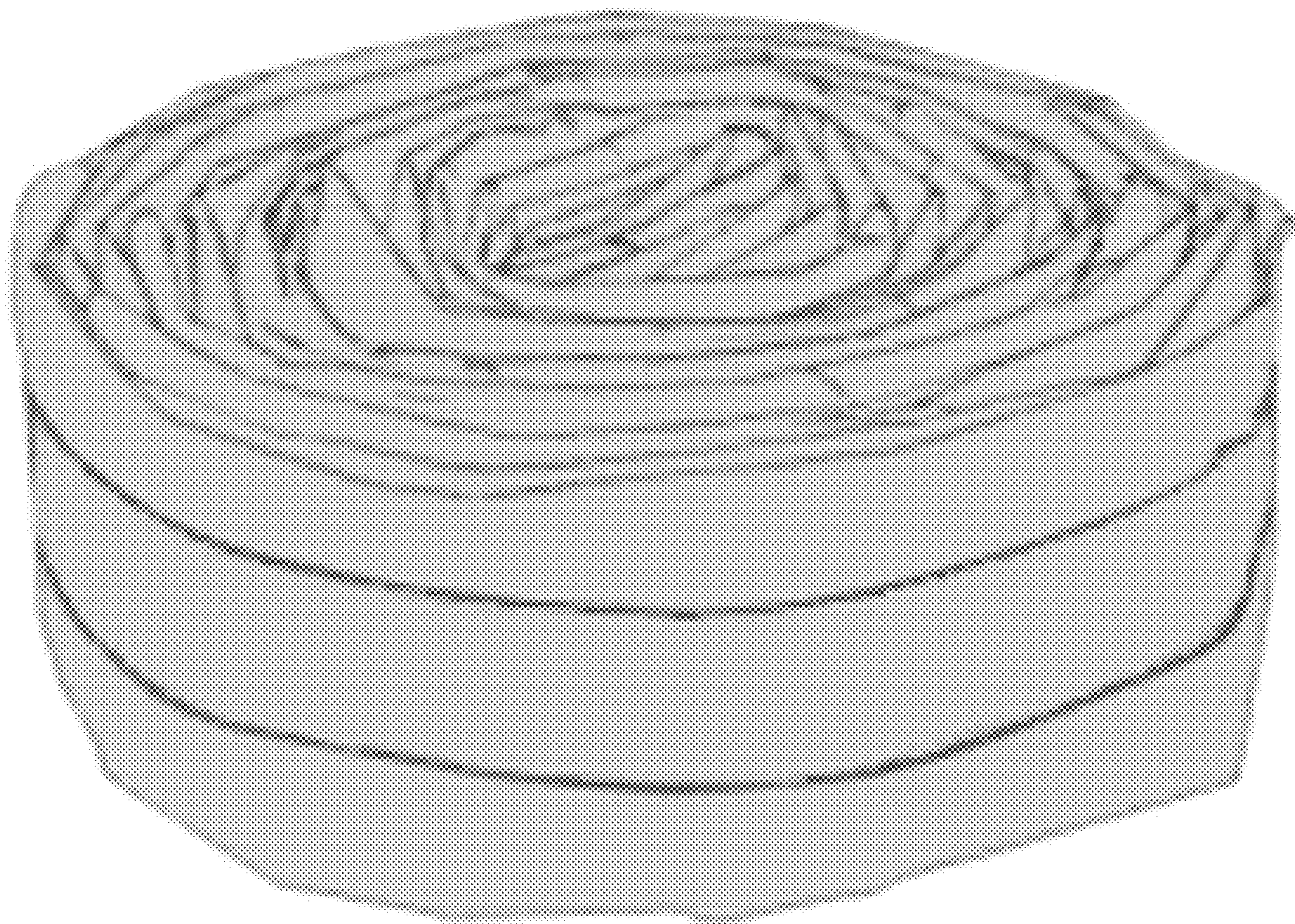

7.2

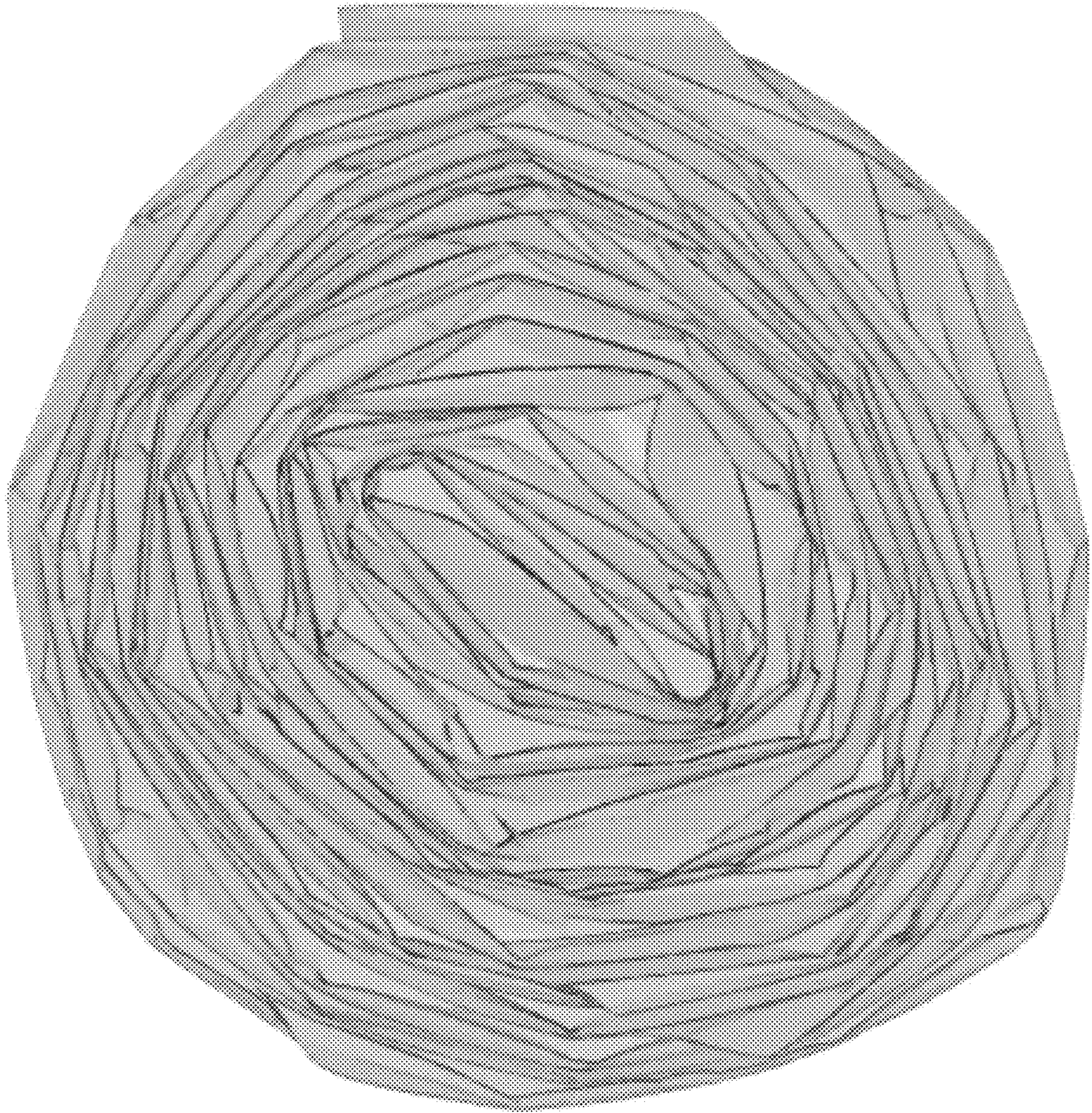

8.1

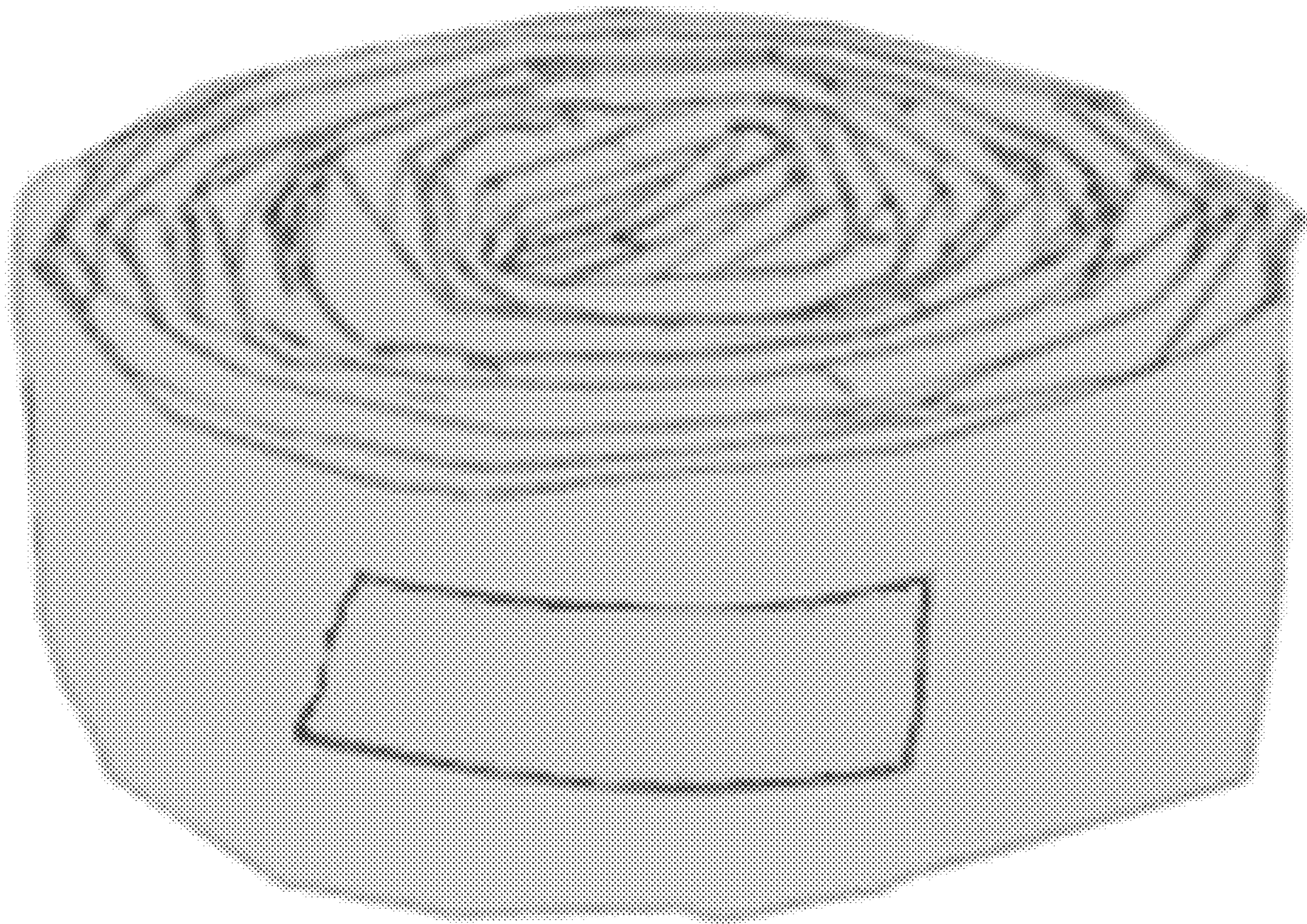

8.2

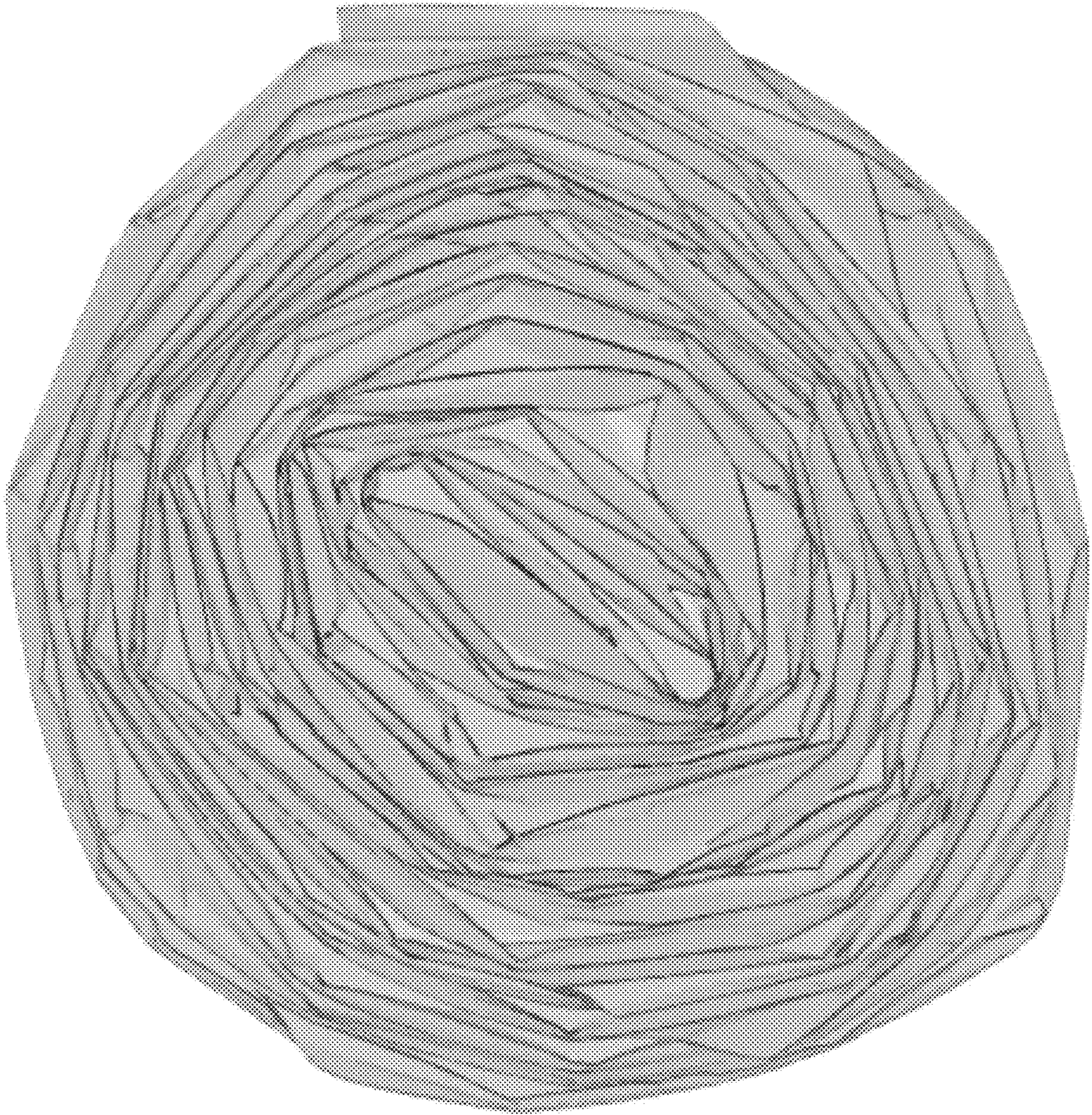

10.1

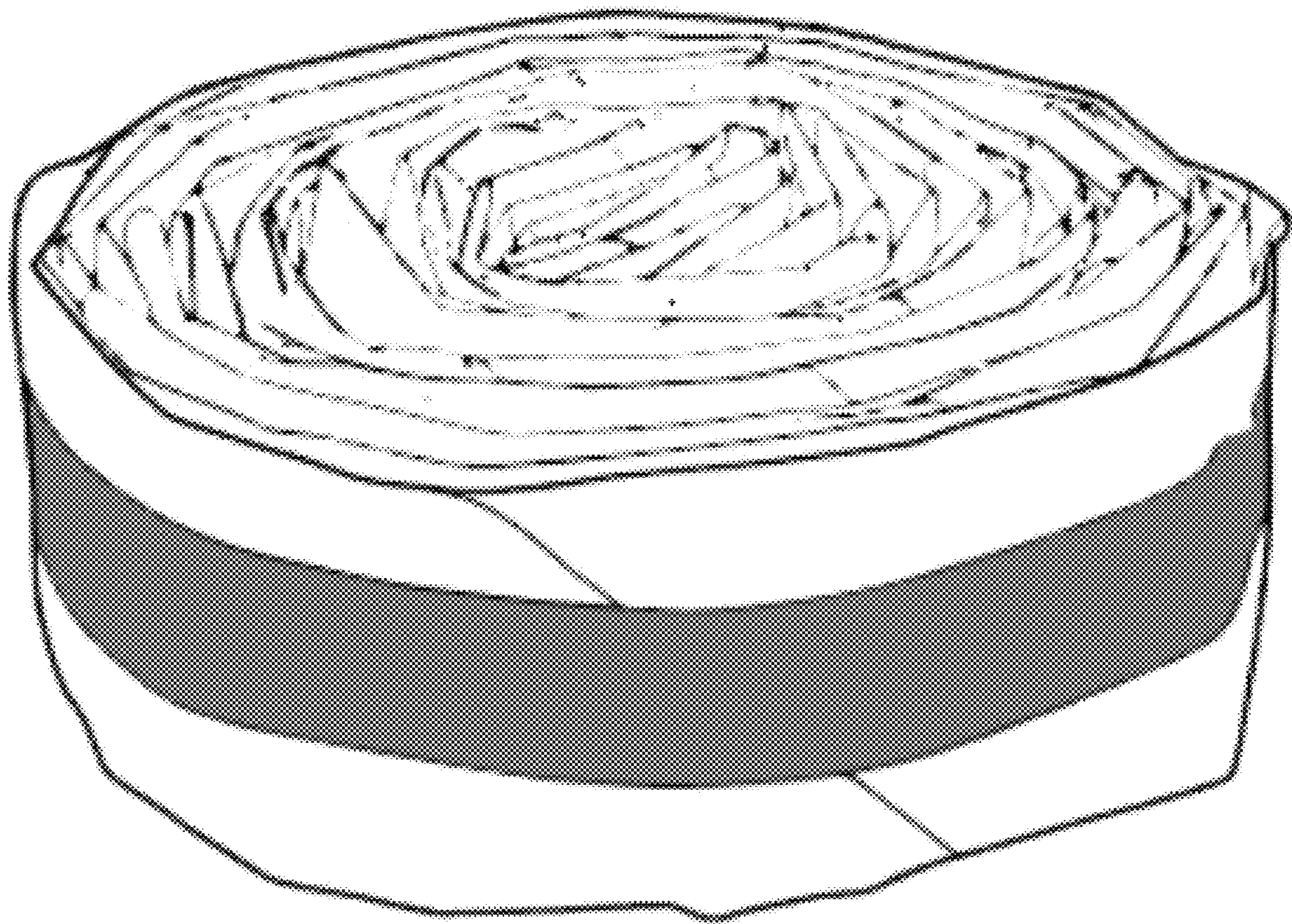

10.2

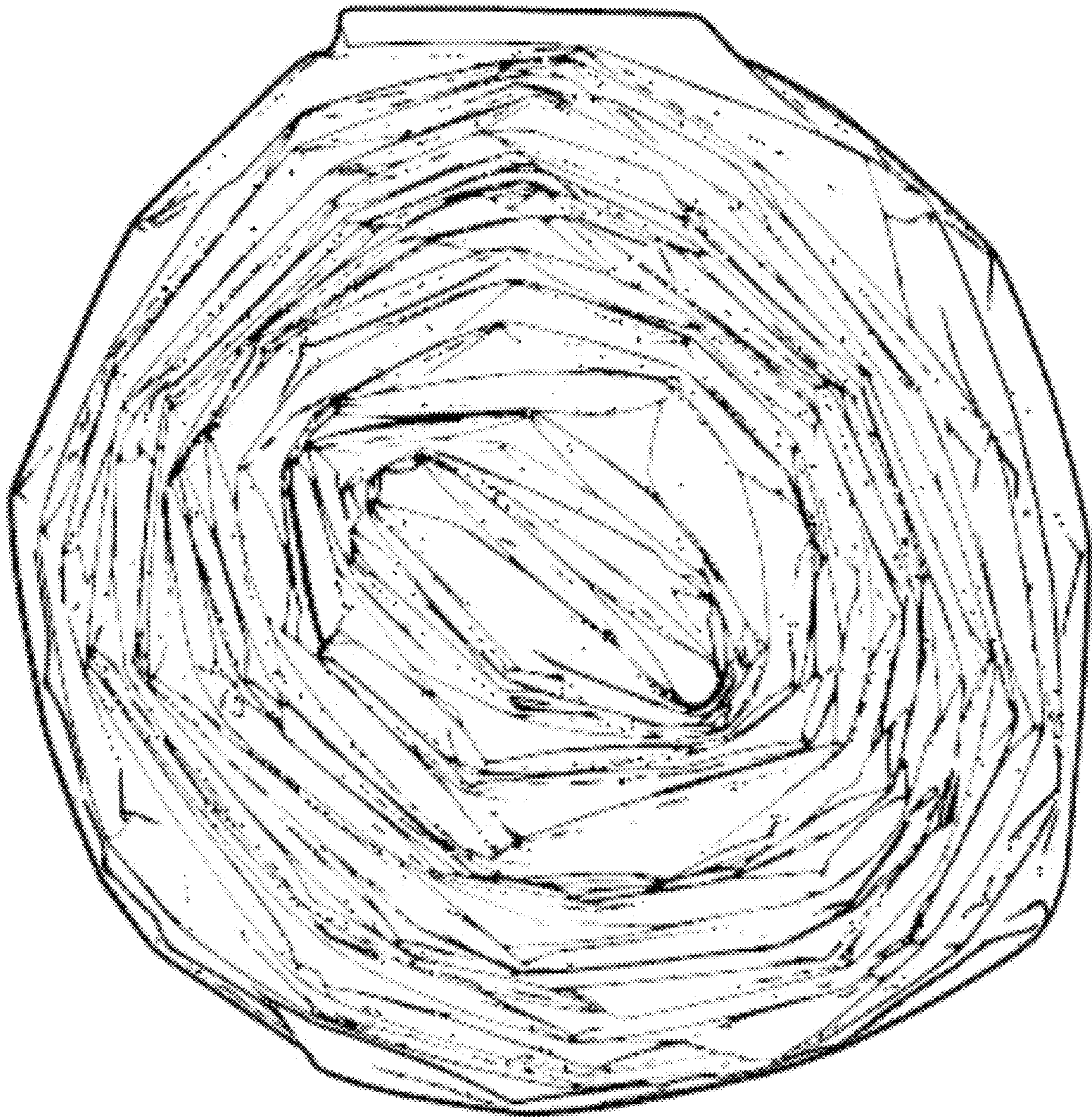

11.1

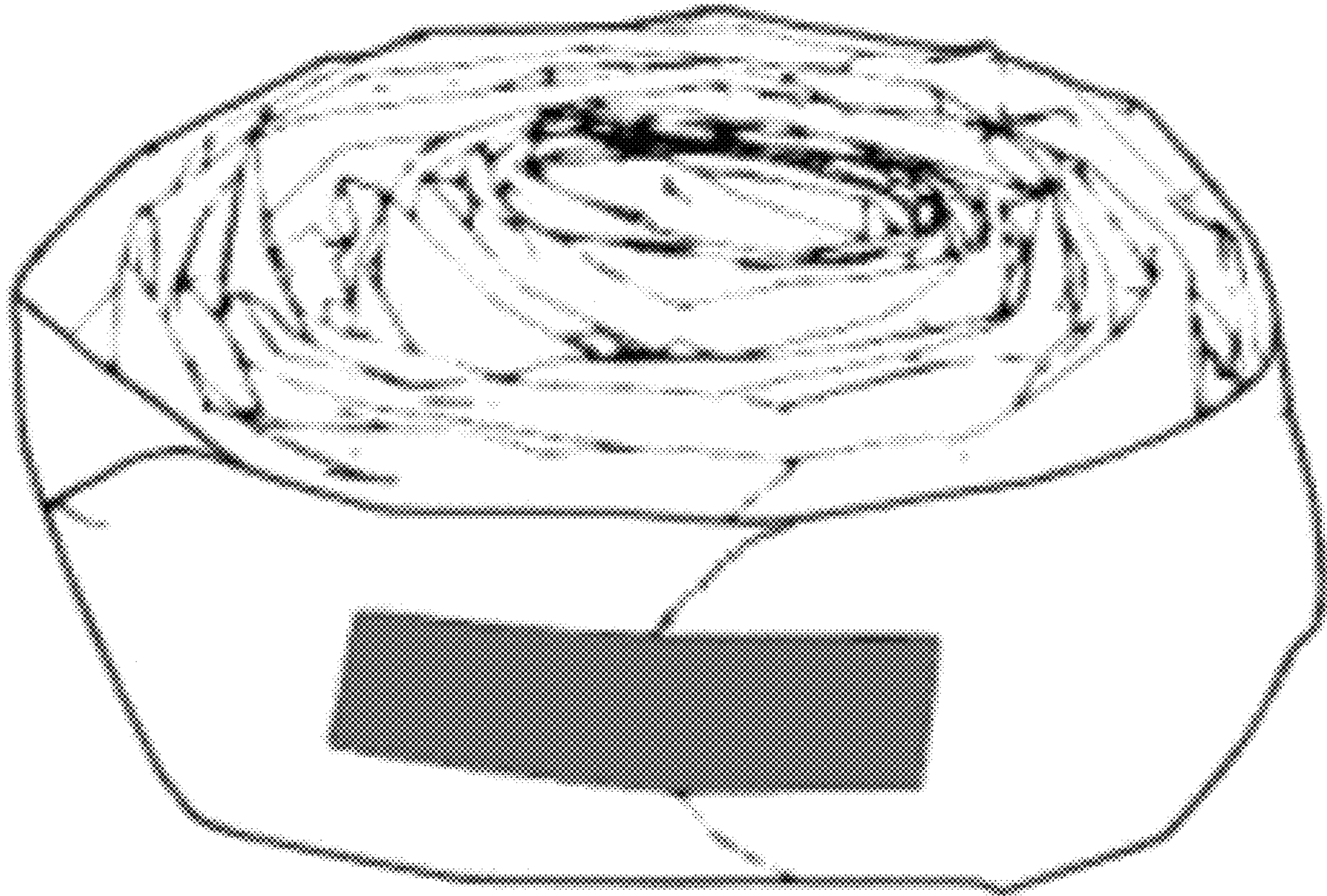

11.2



12.1

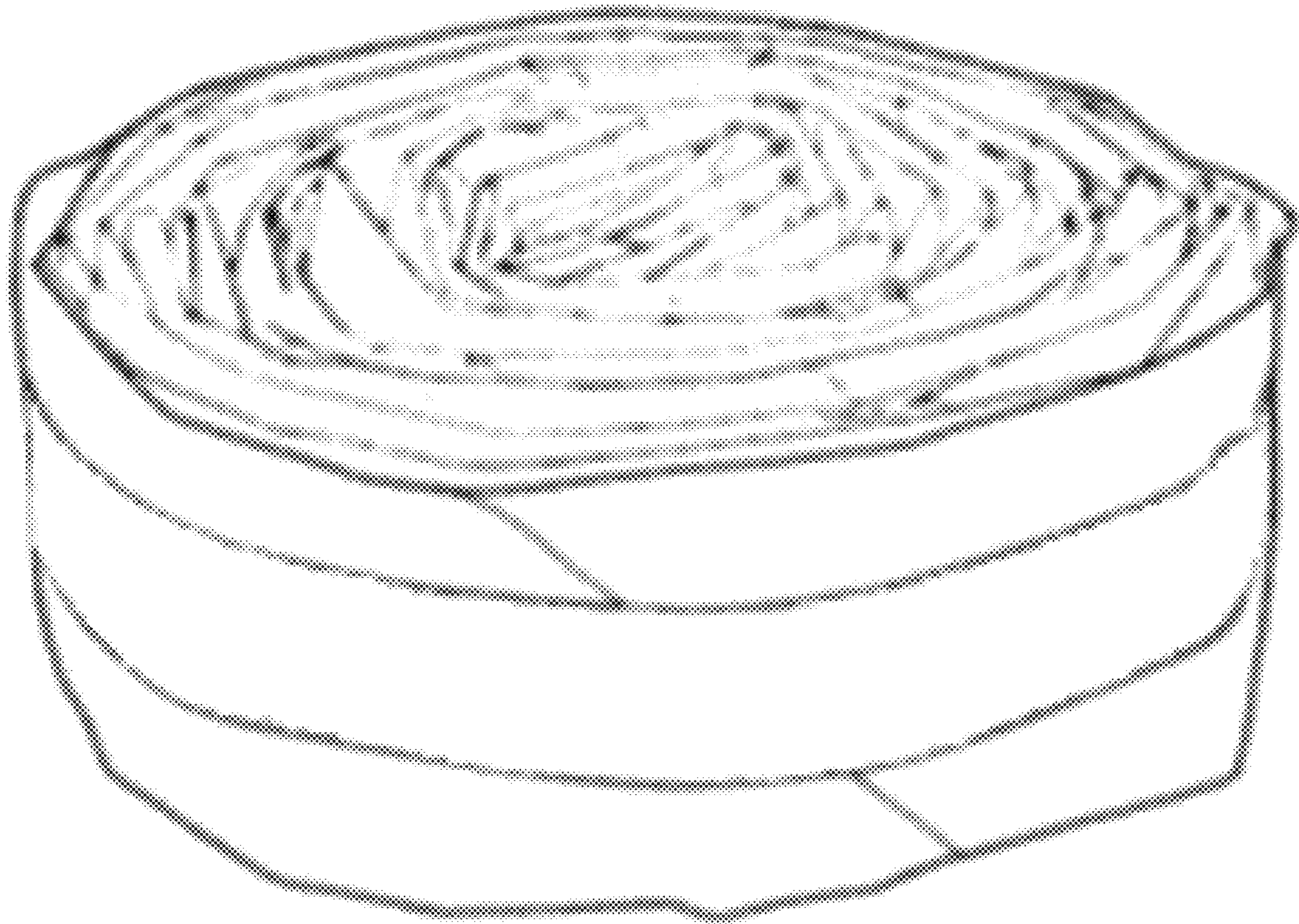

12.2

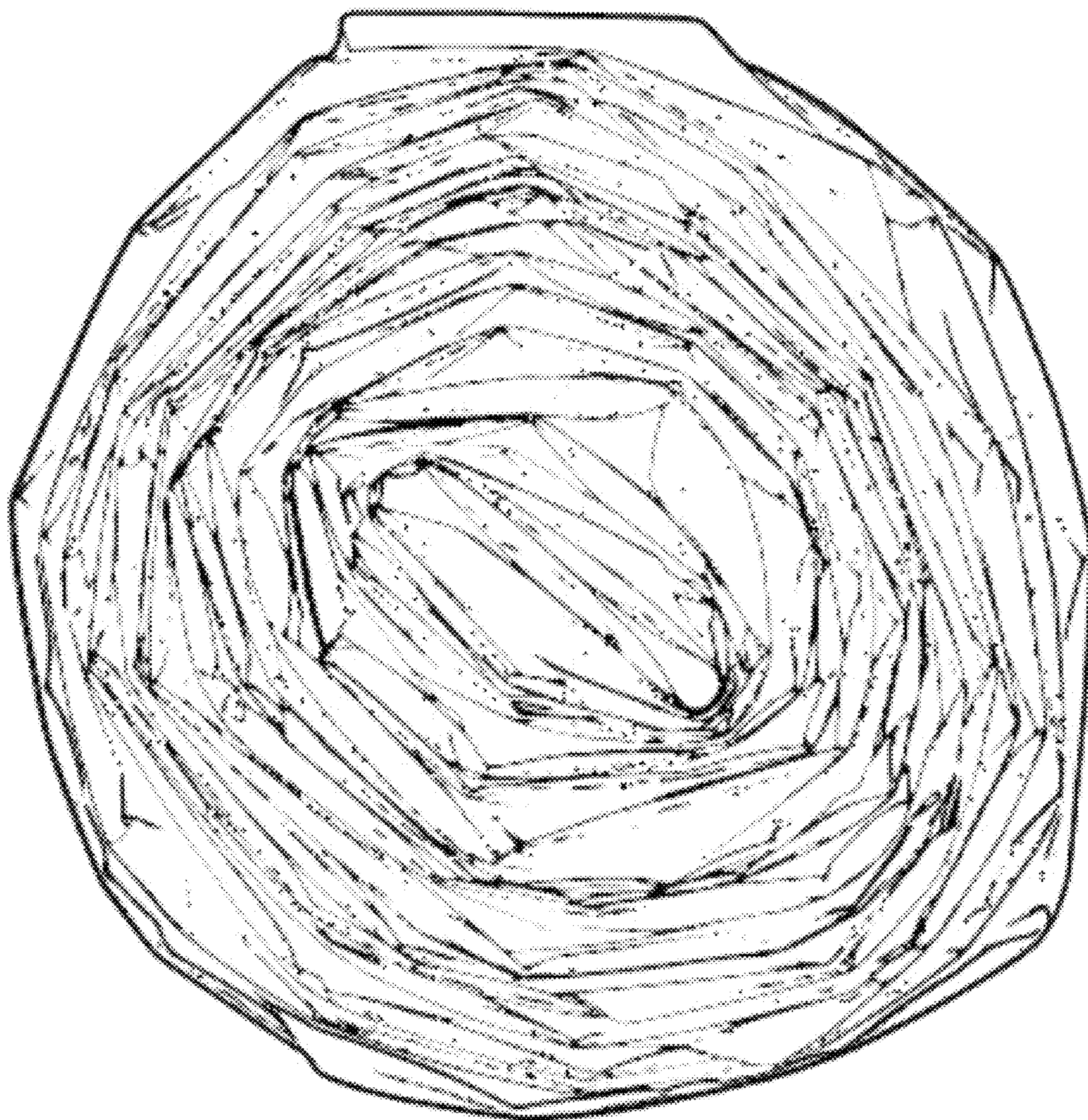

13.1

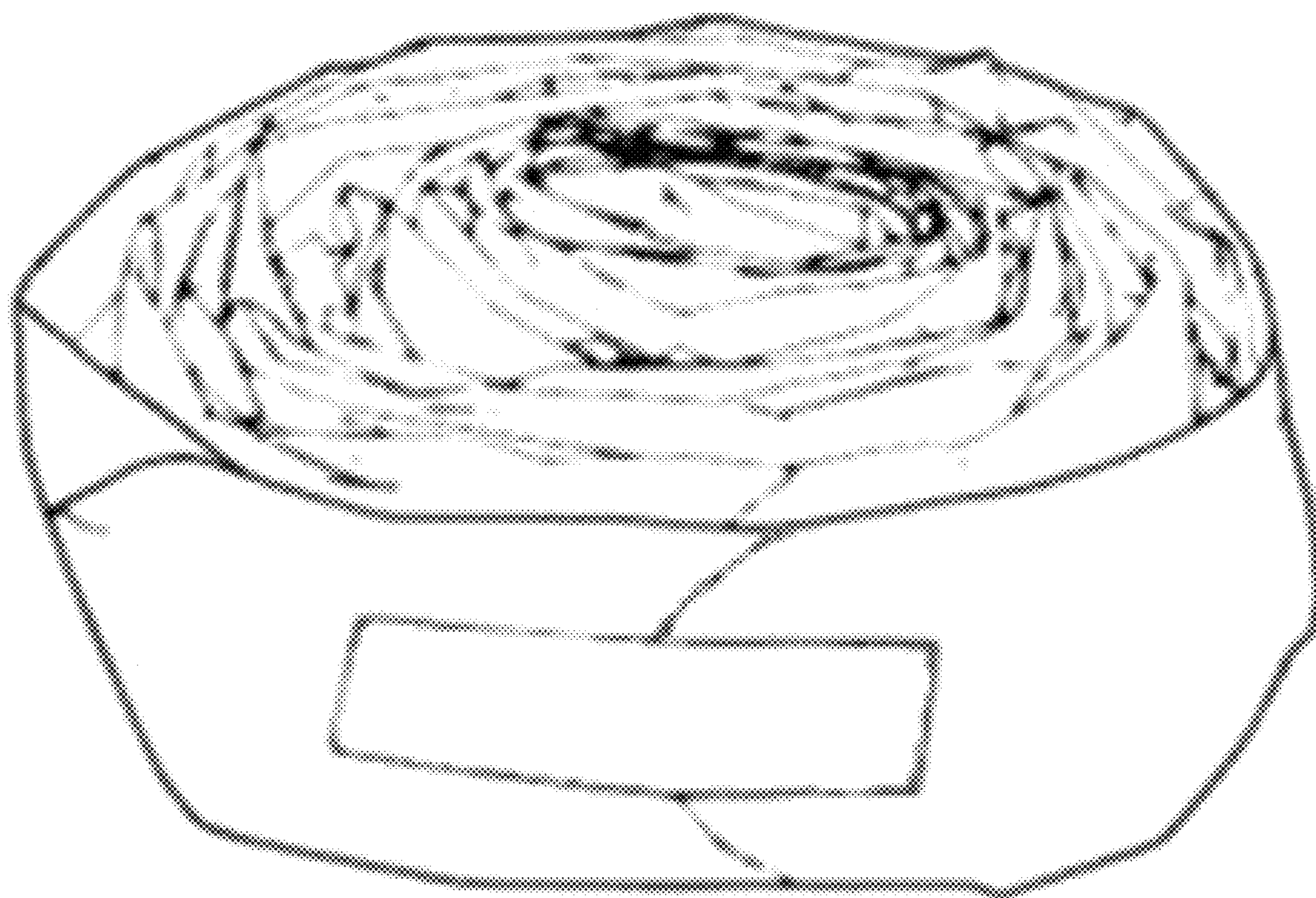

13.2

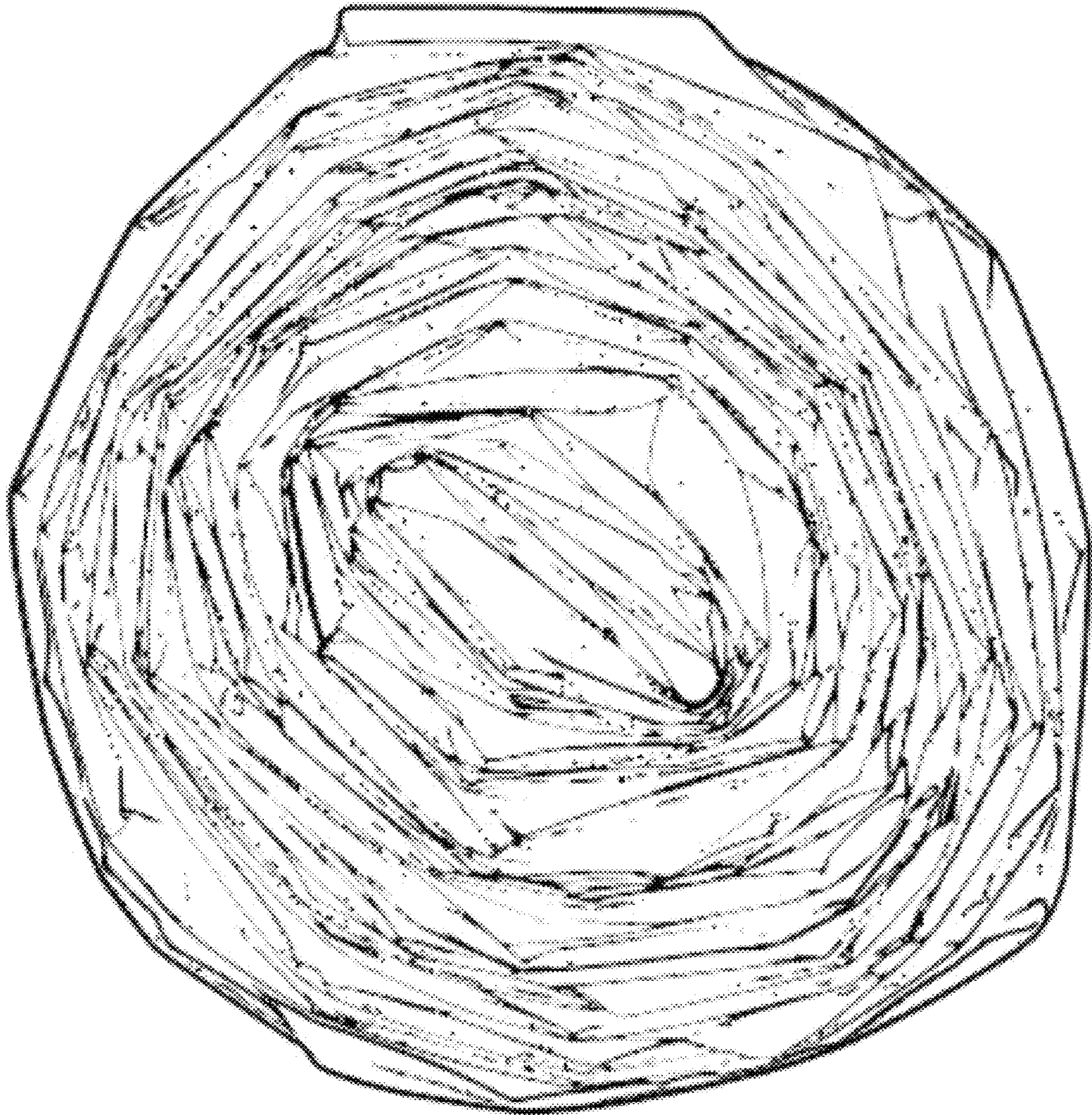

15.1

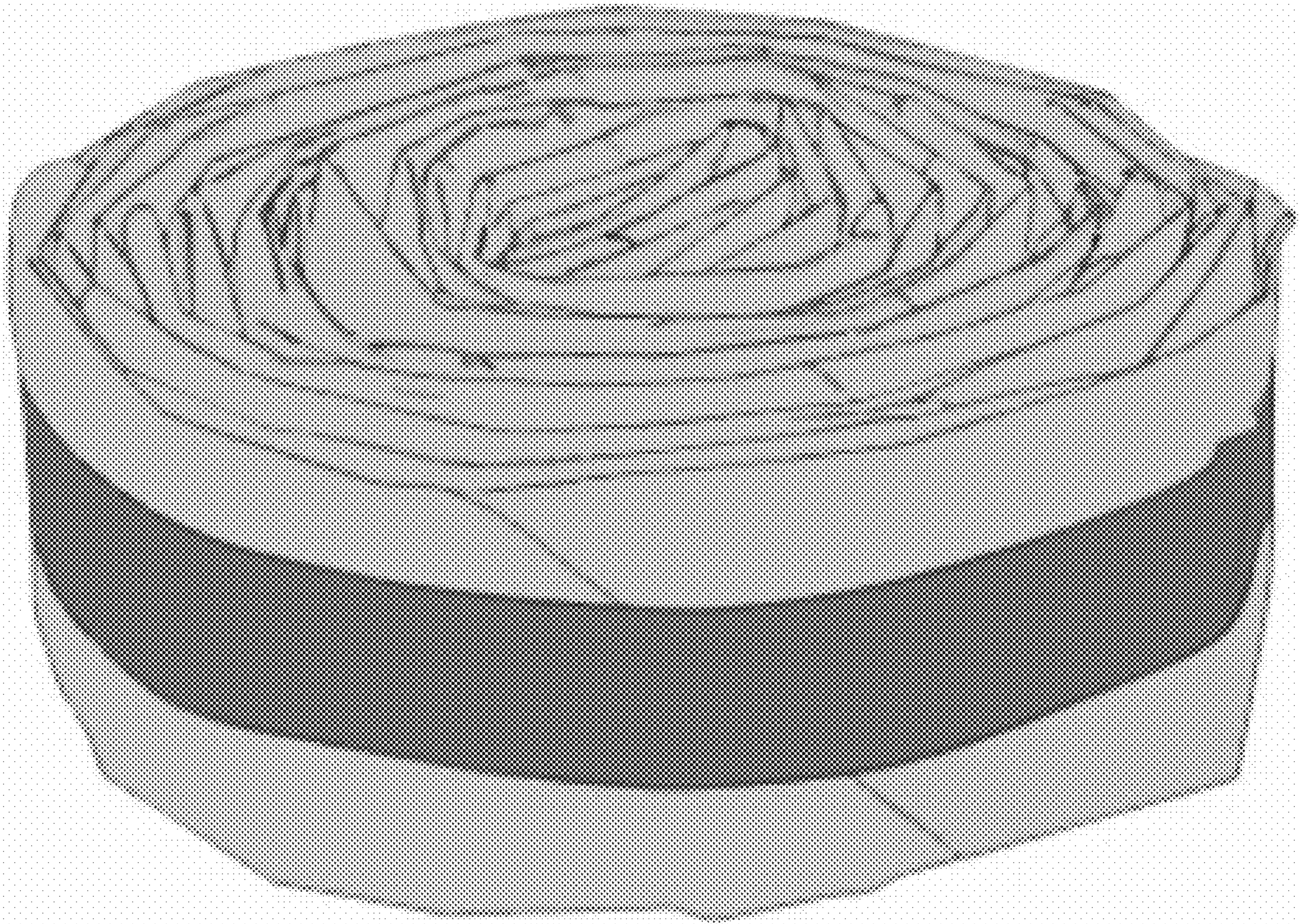

15.2

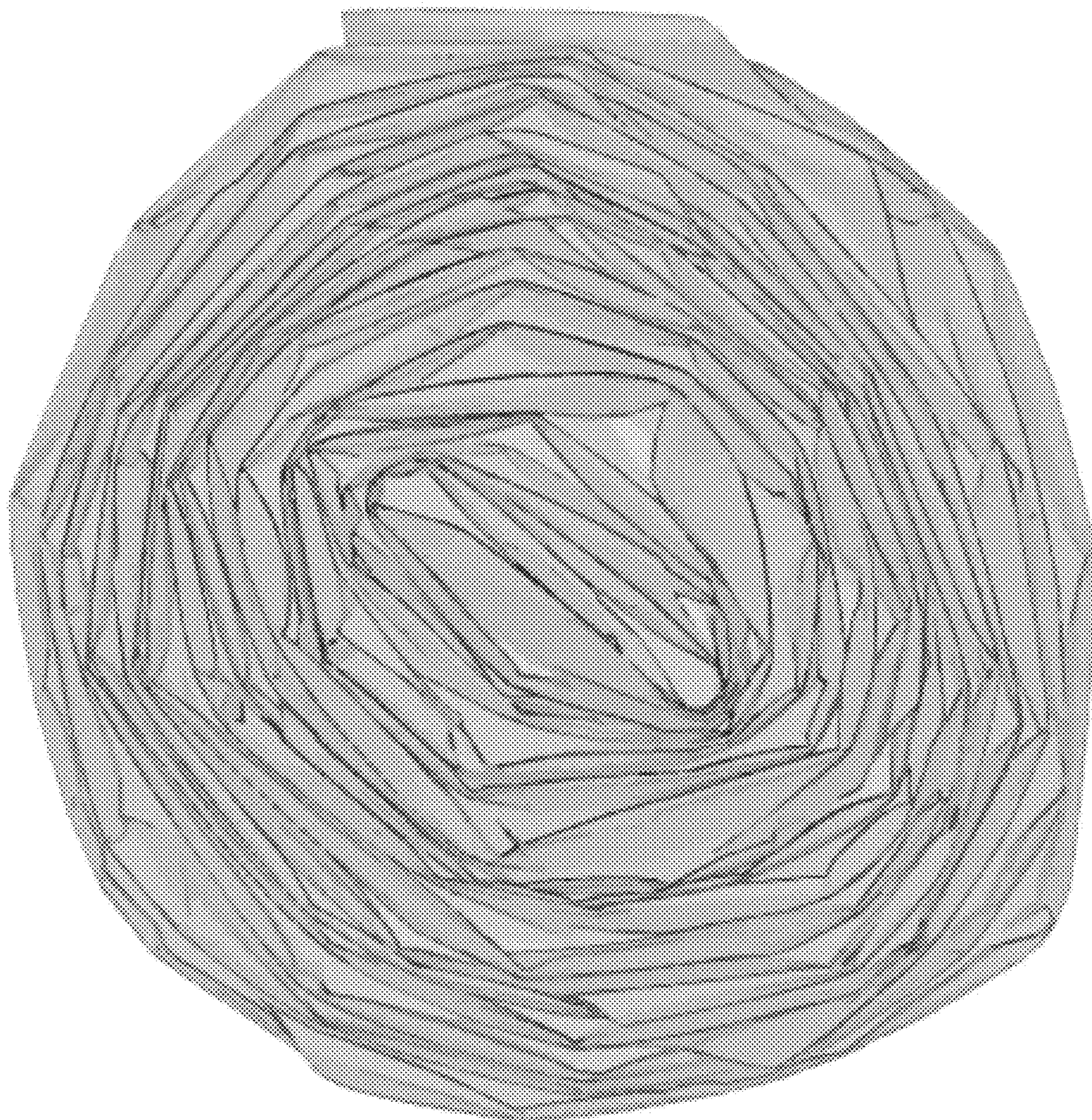

16.1

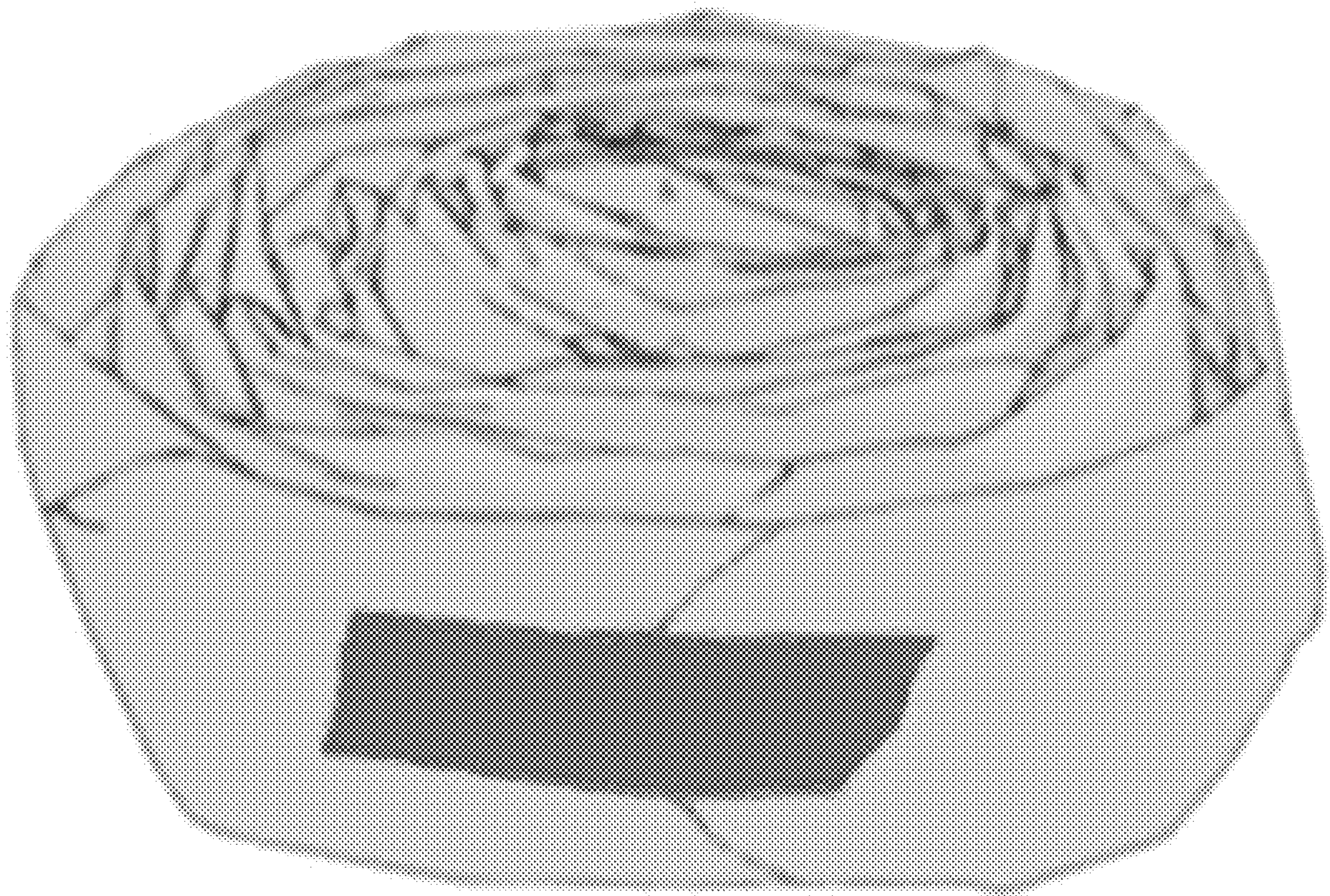

16.2

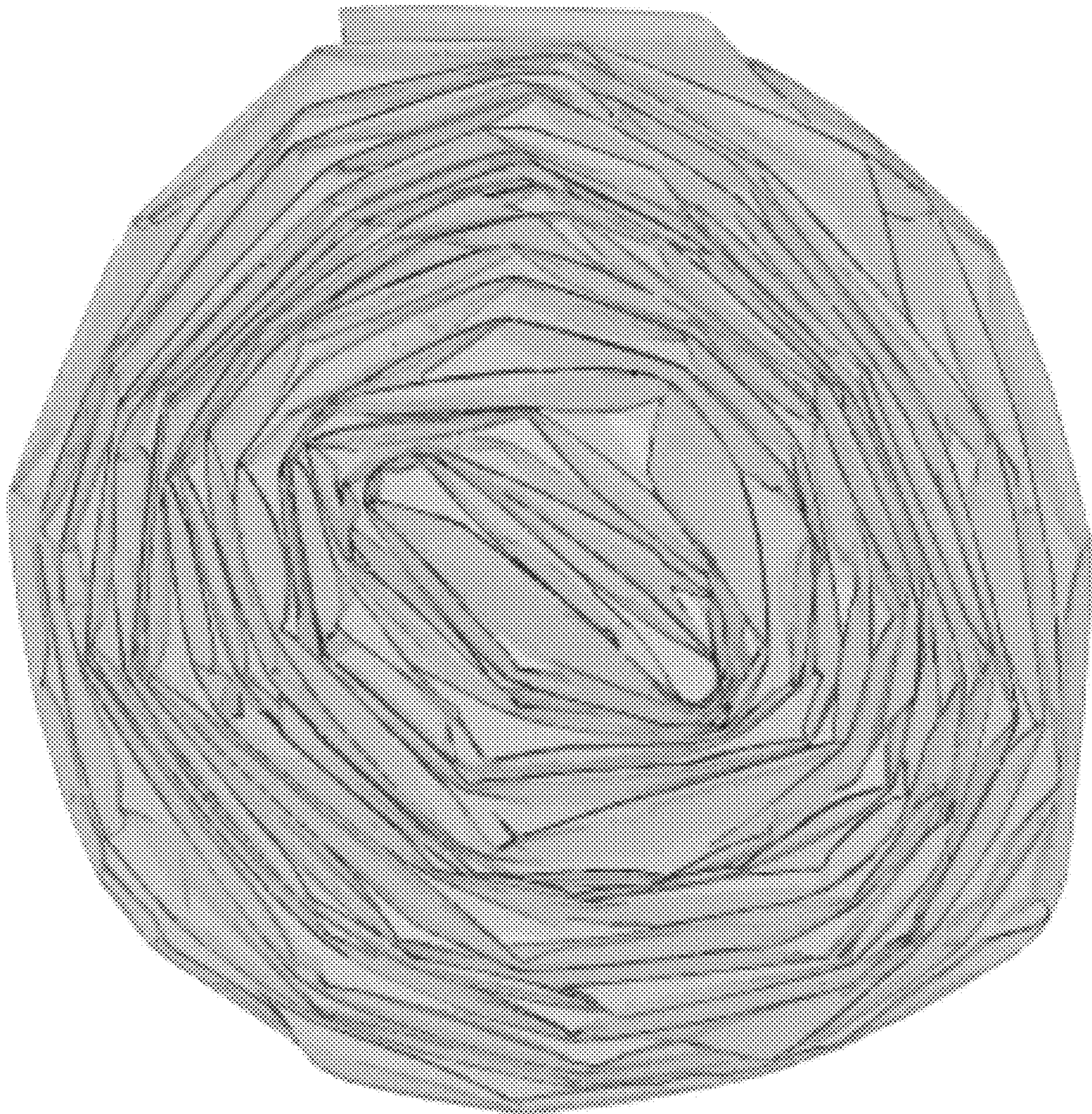

17.1

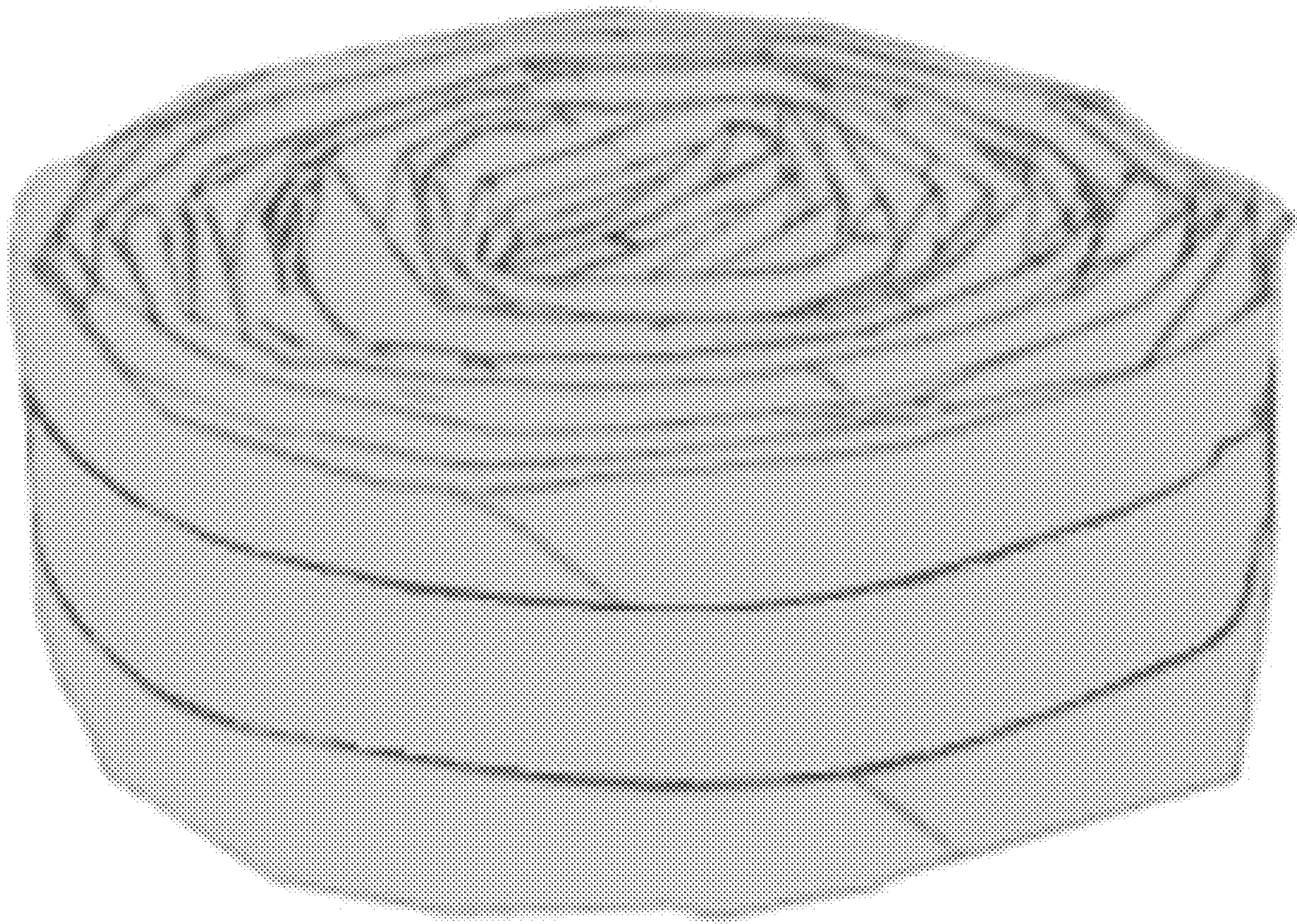

17.2

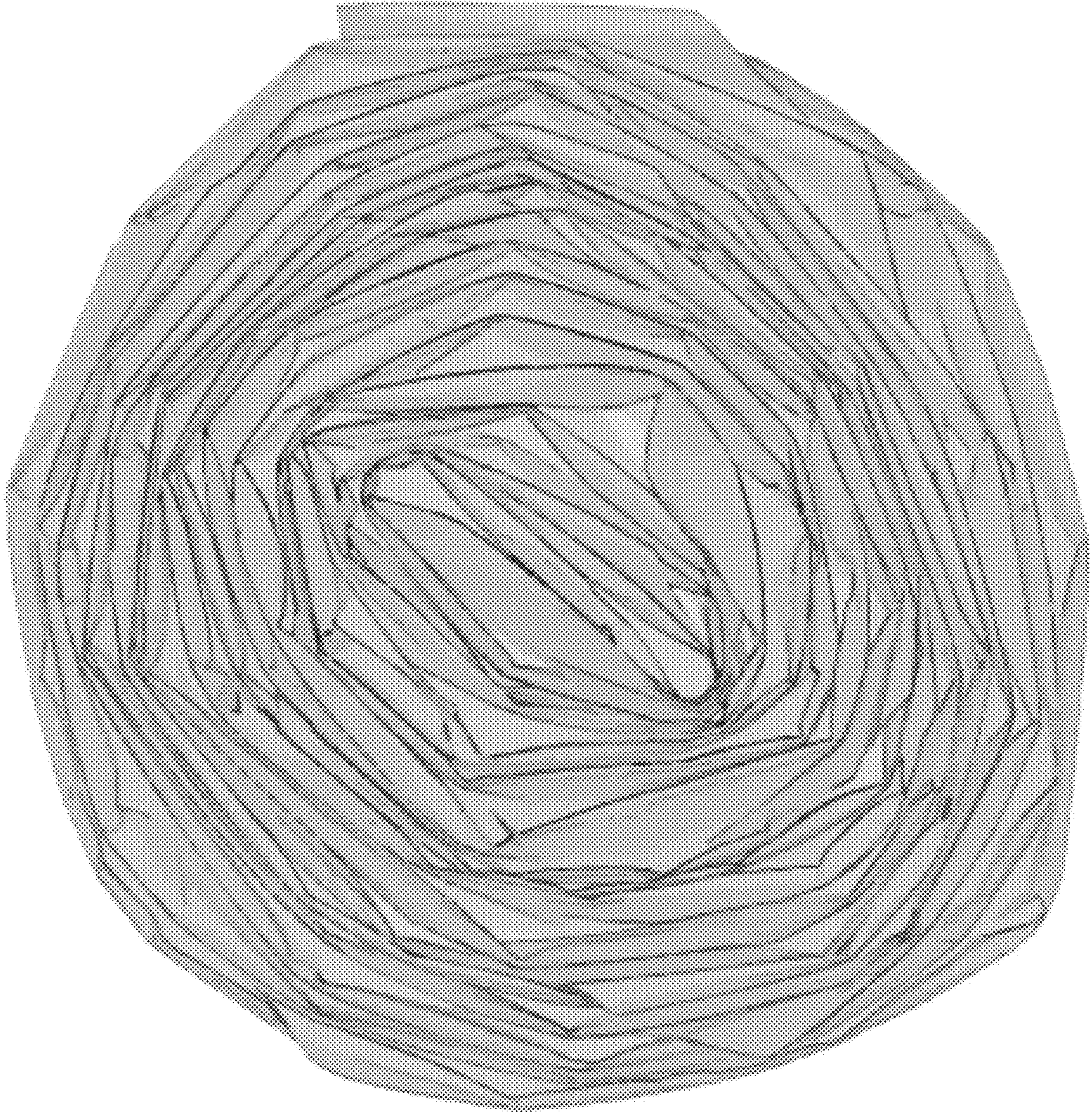

18.1

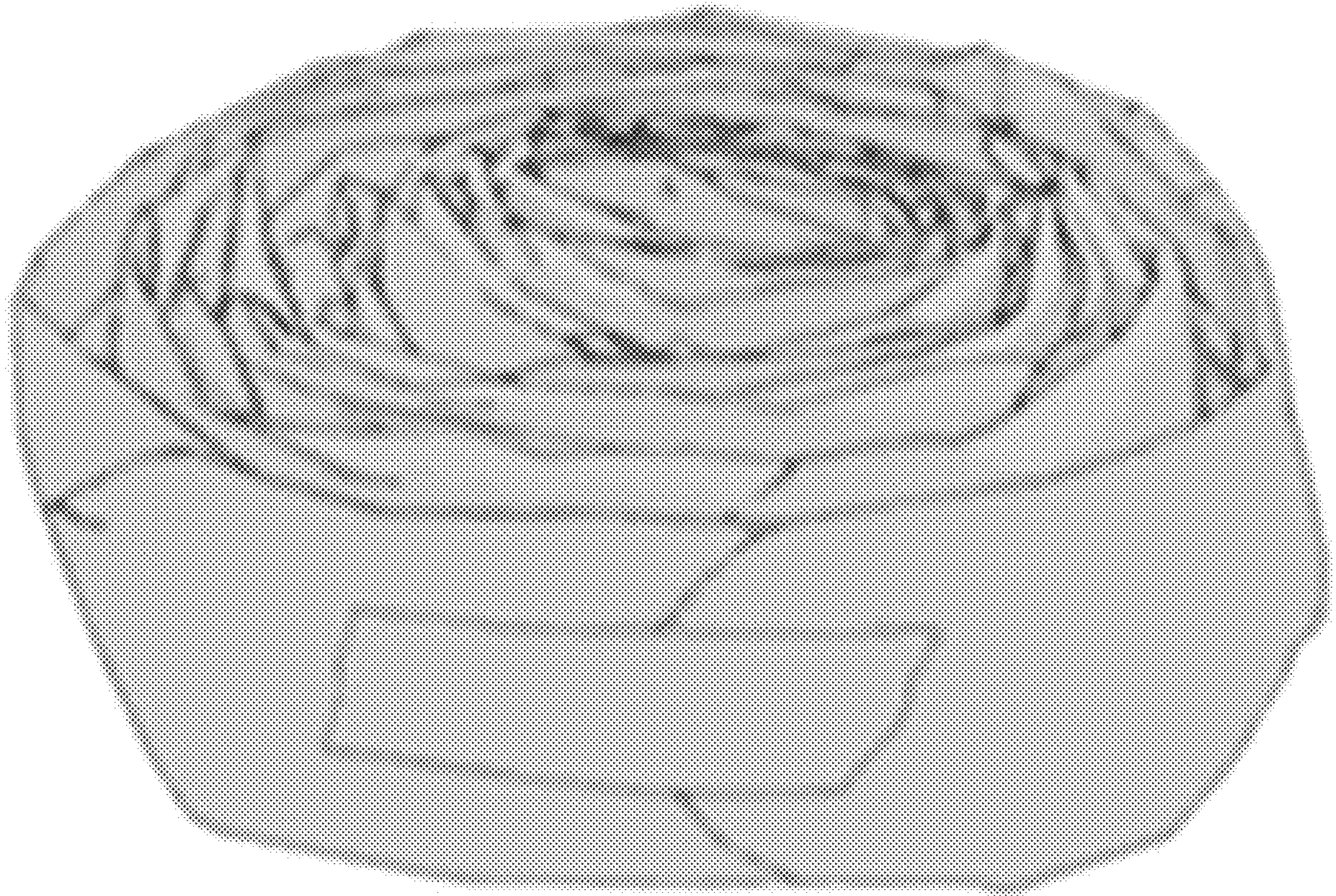

18.2

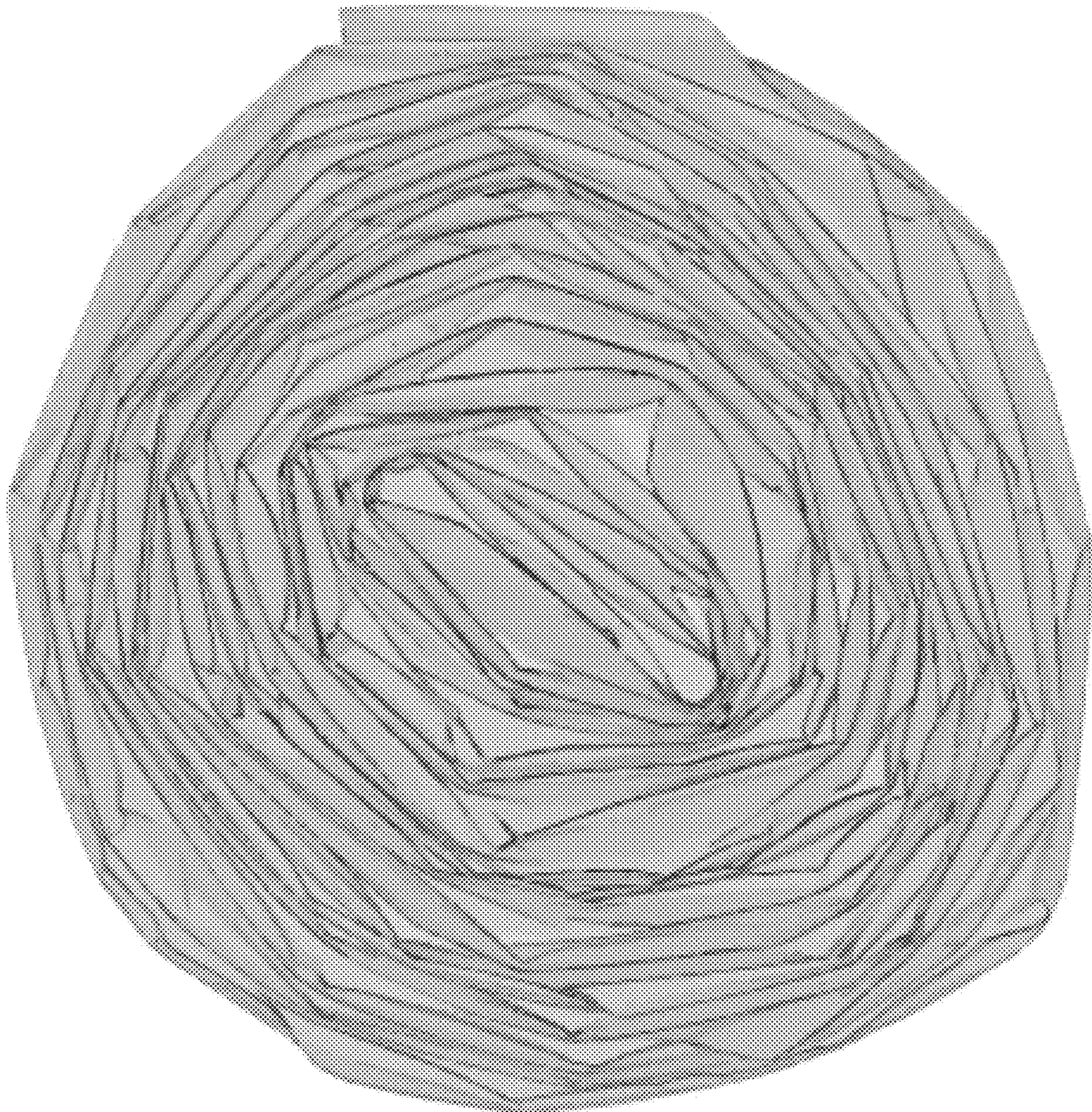

20.1

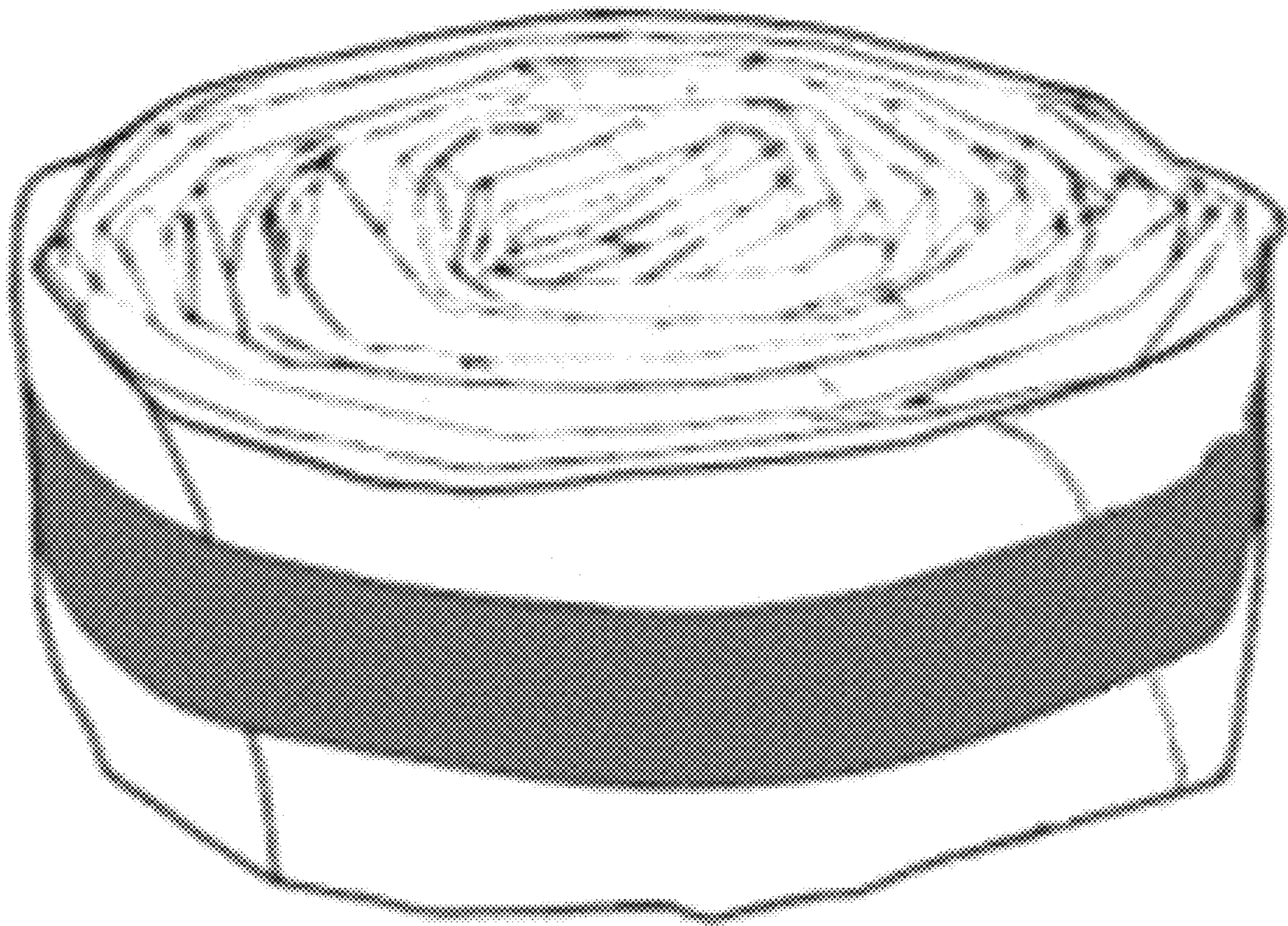

20.2

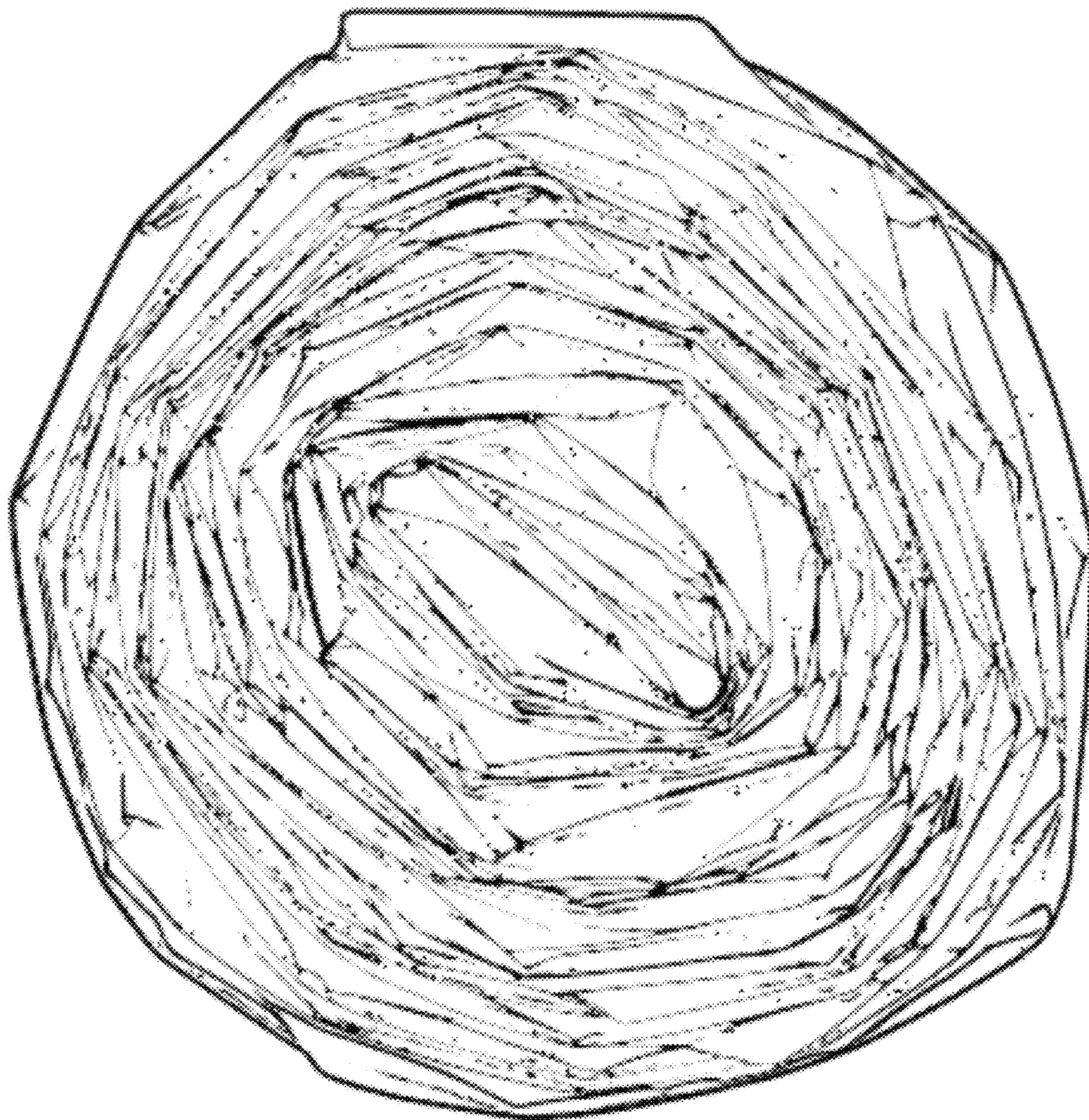

21.1

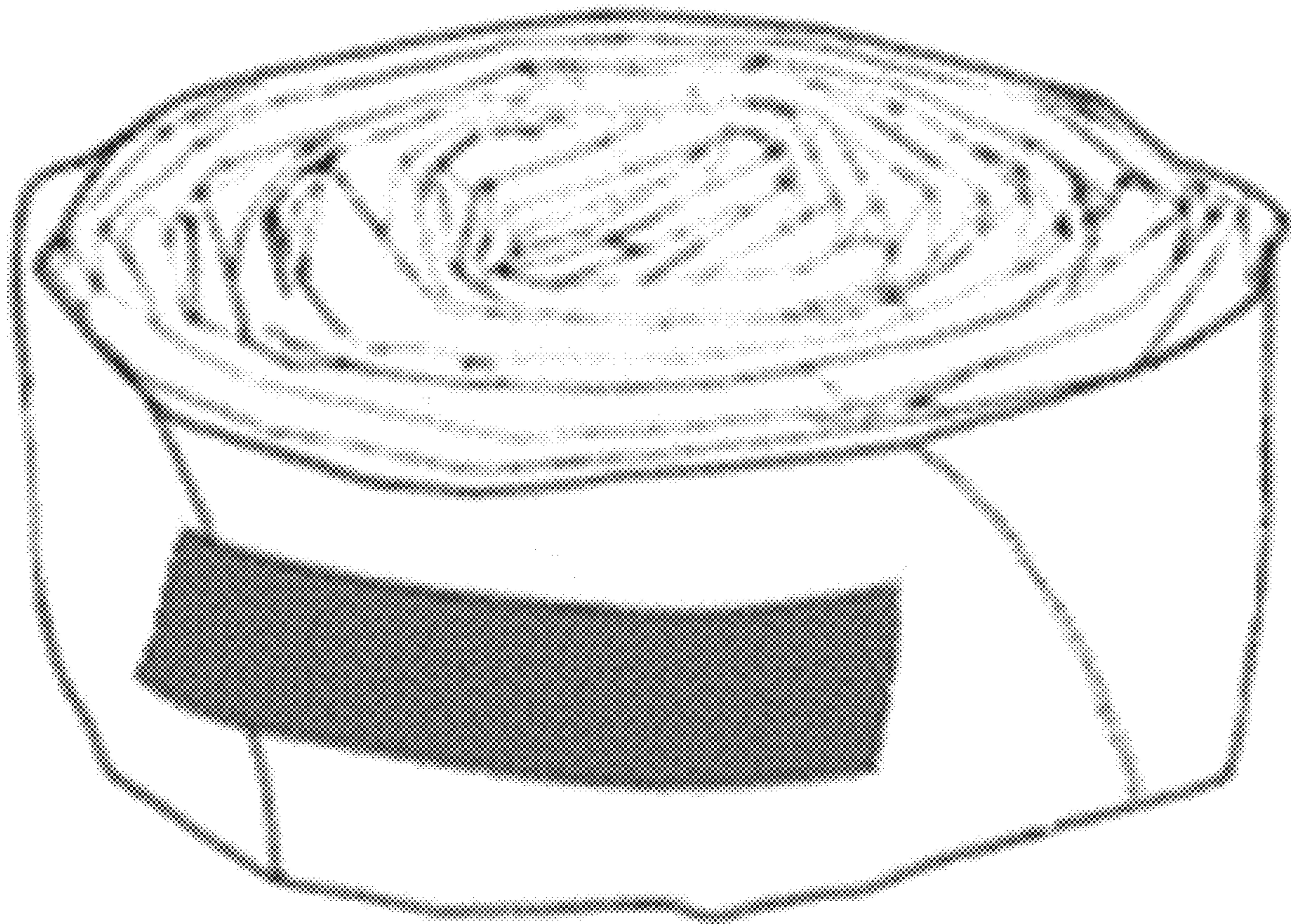

21.2

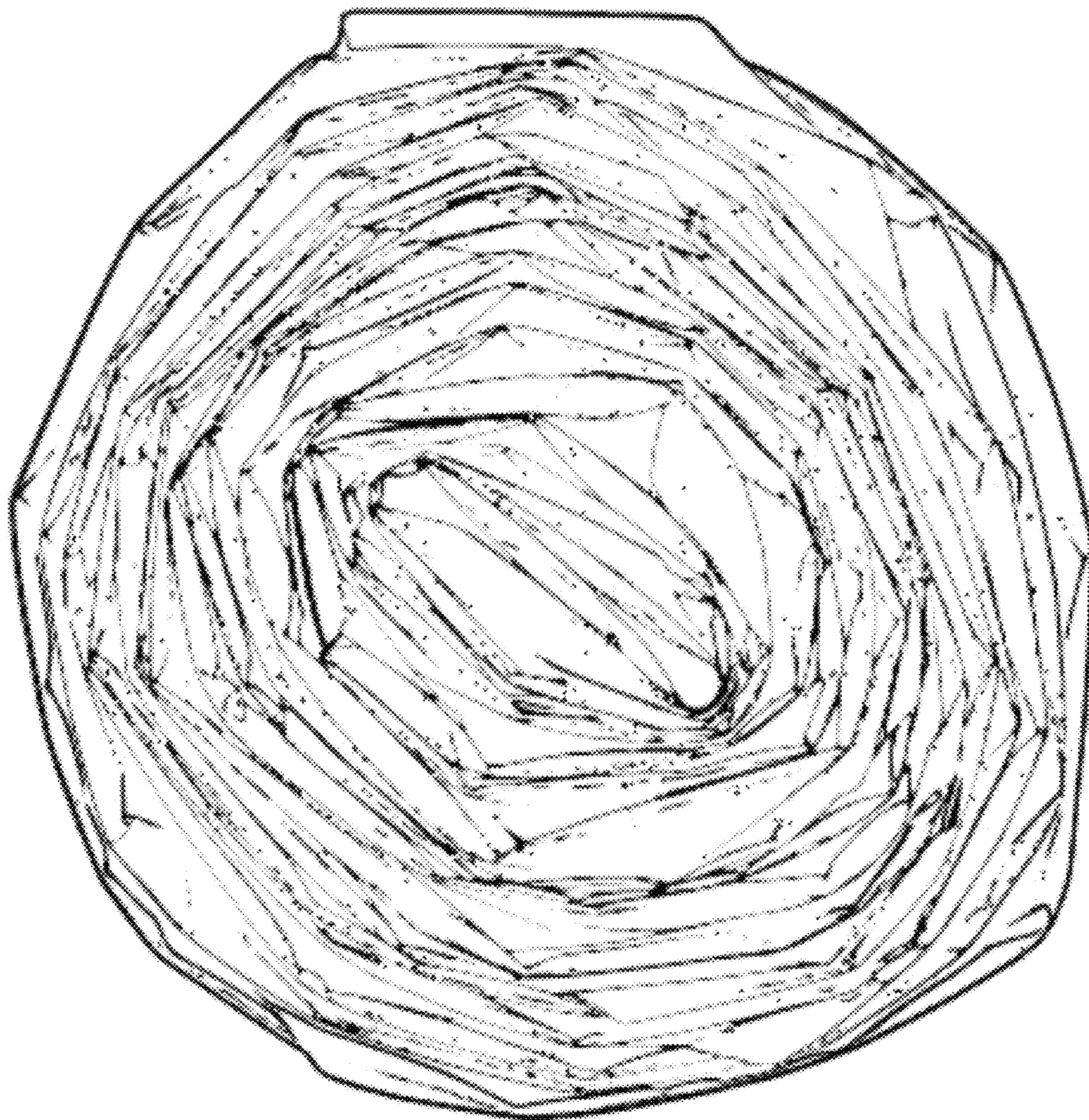

22.1

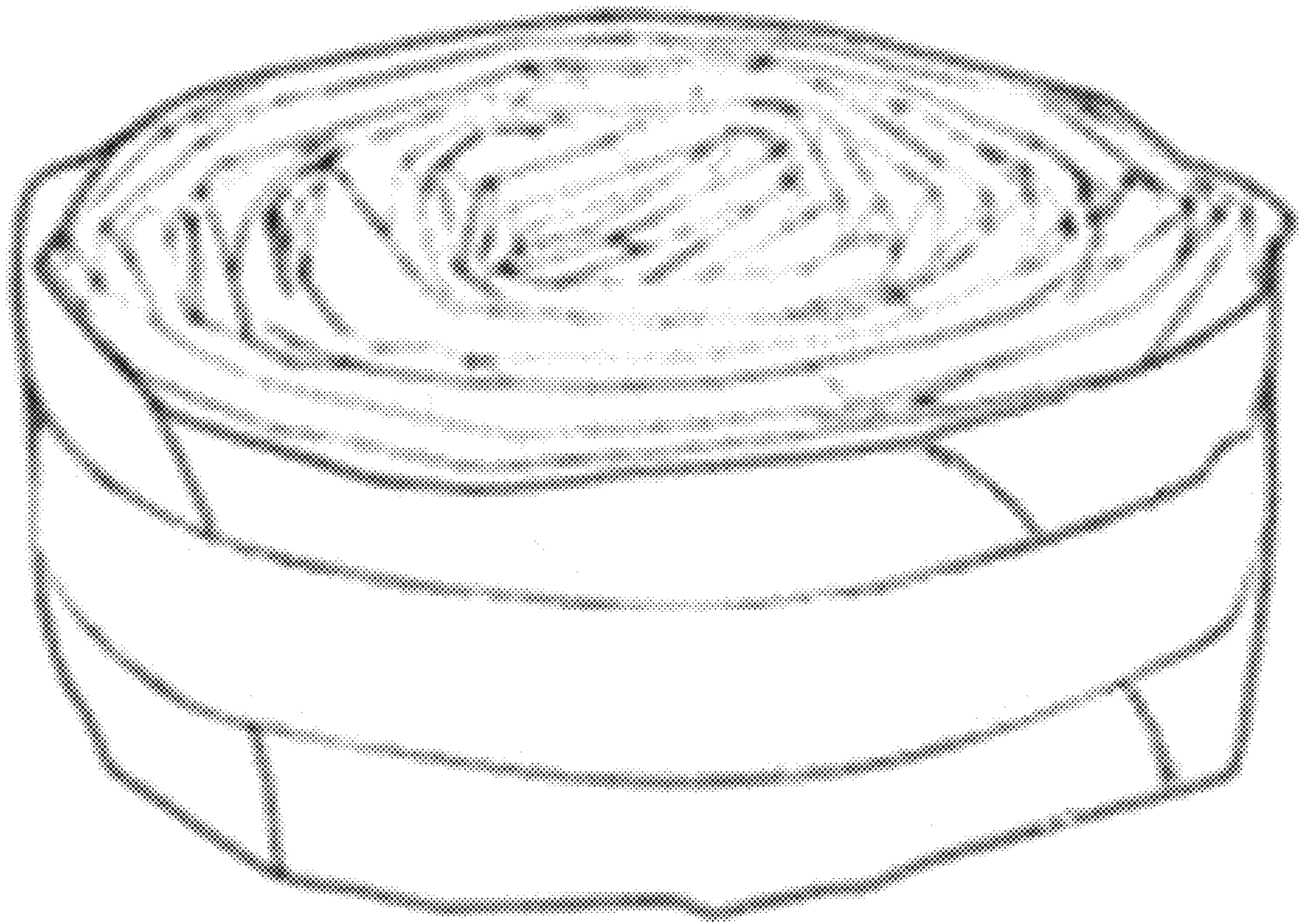

22.2

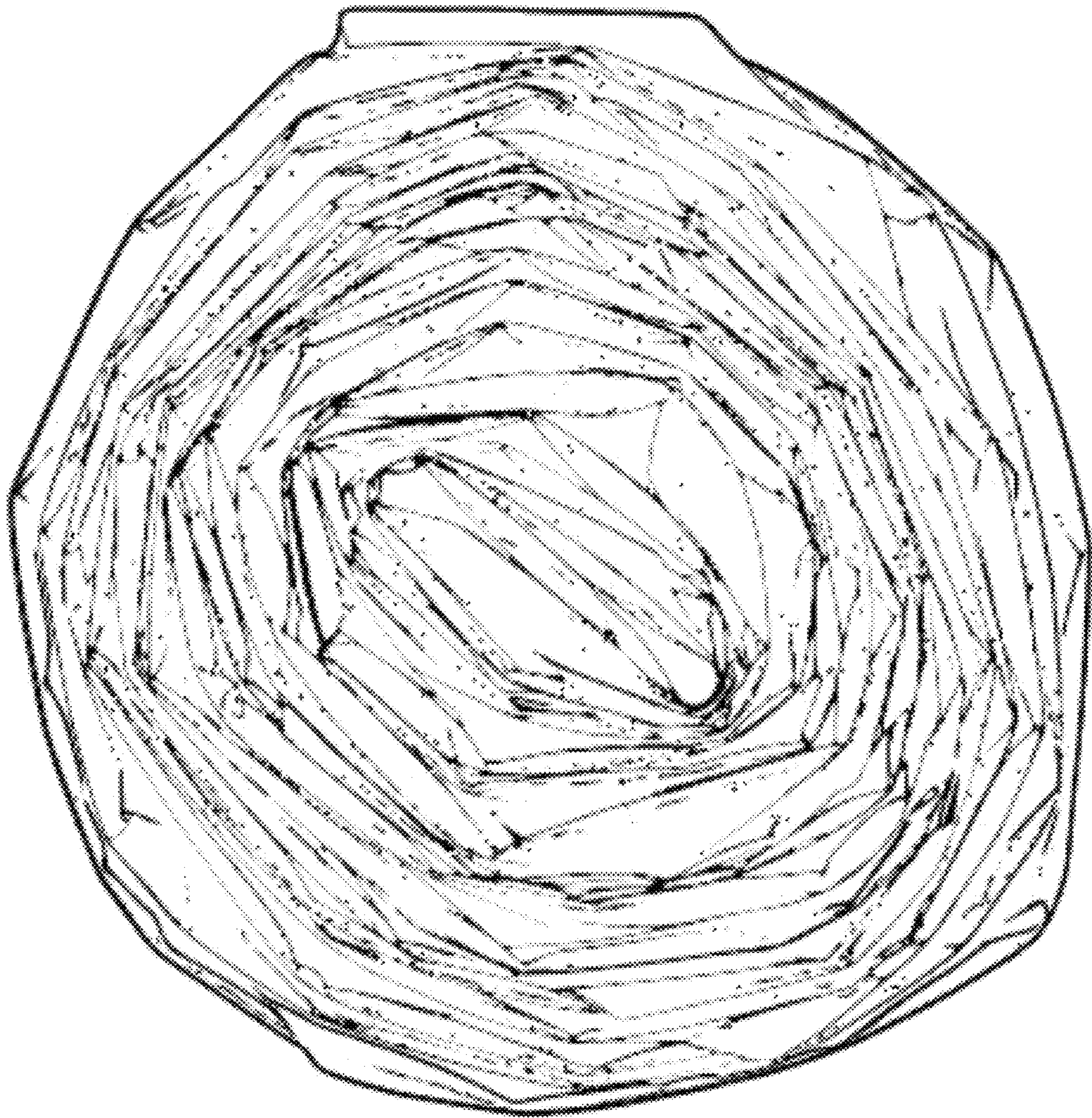

23.1

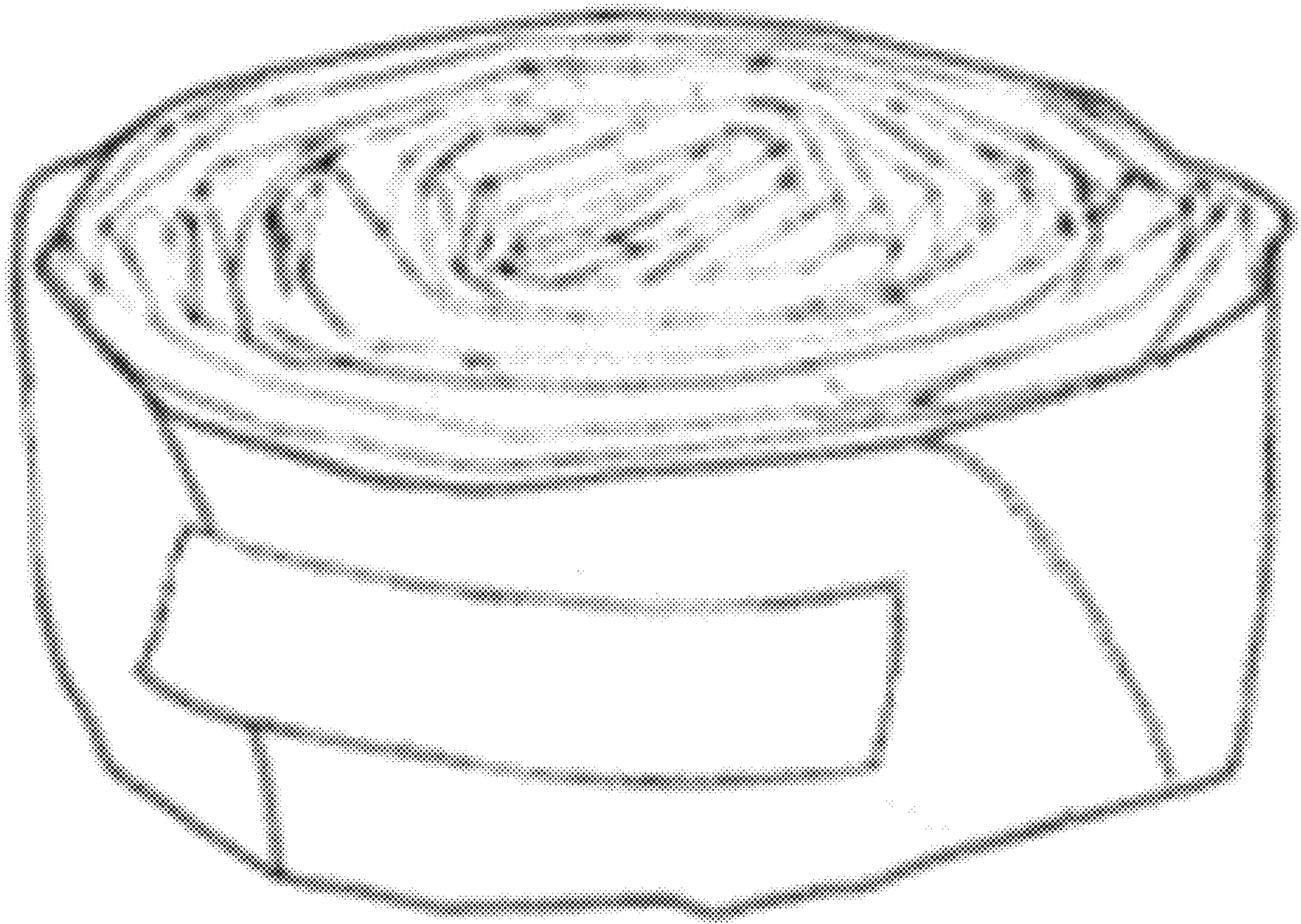

23.2

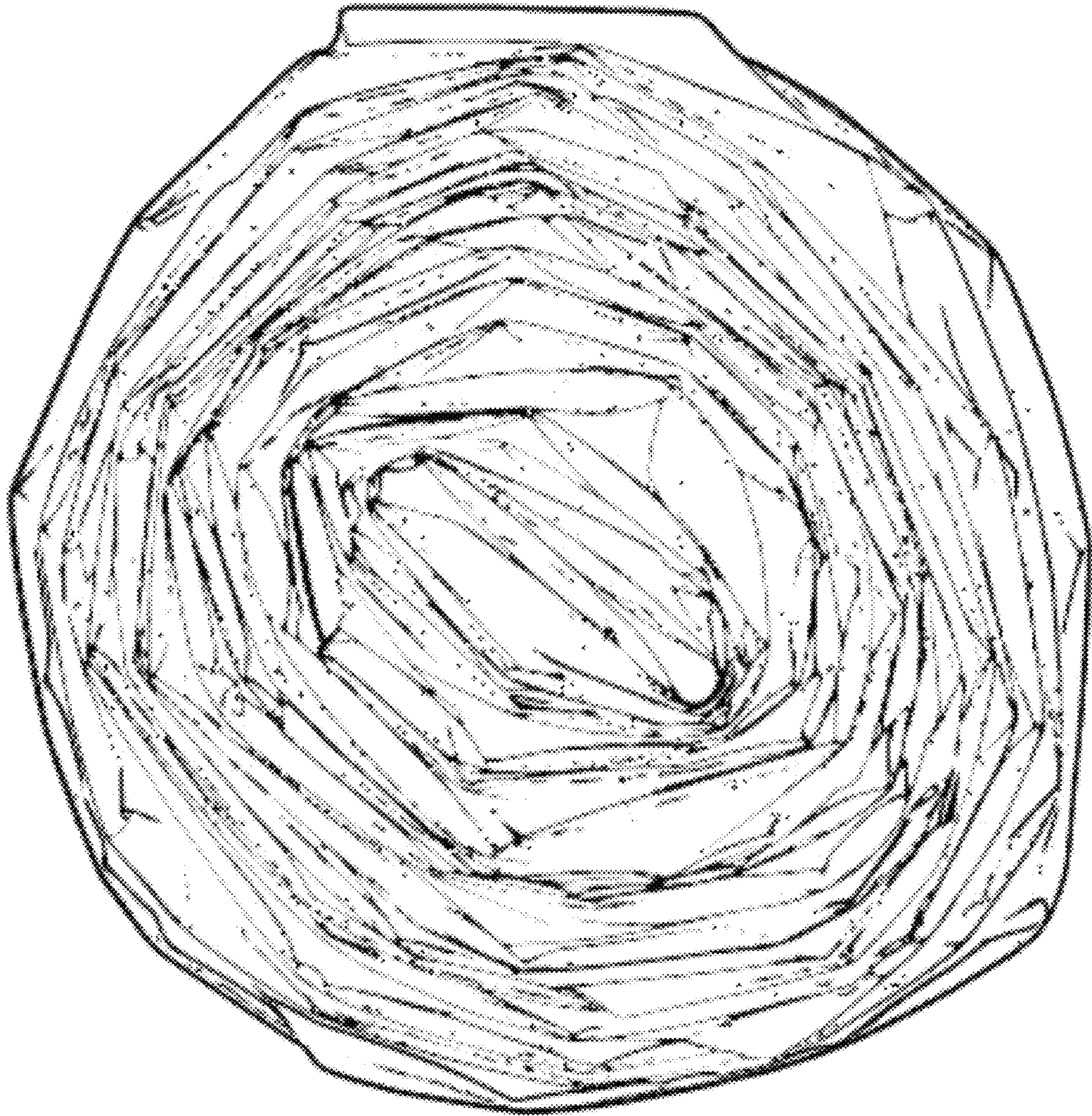

25.1

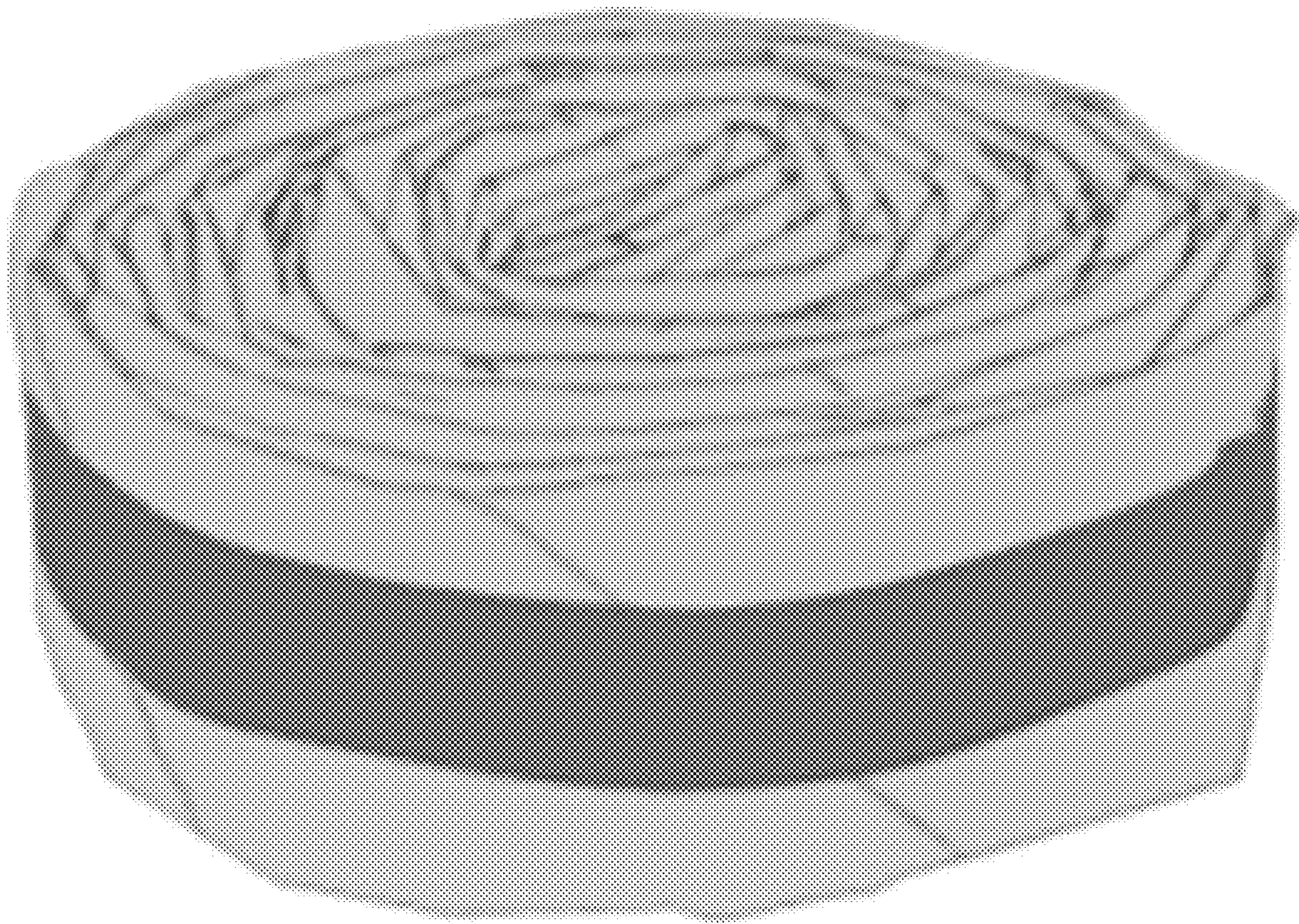

25.2

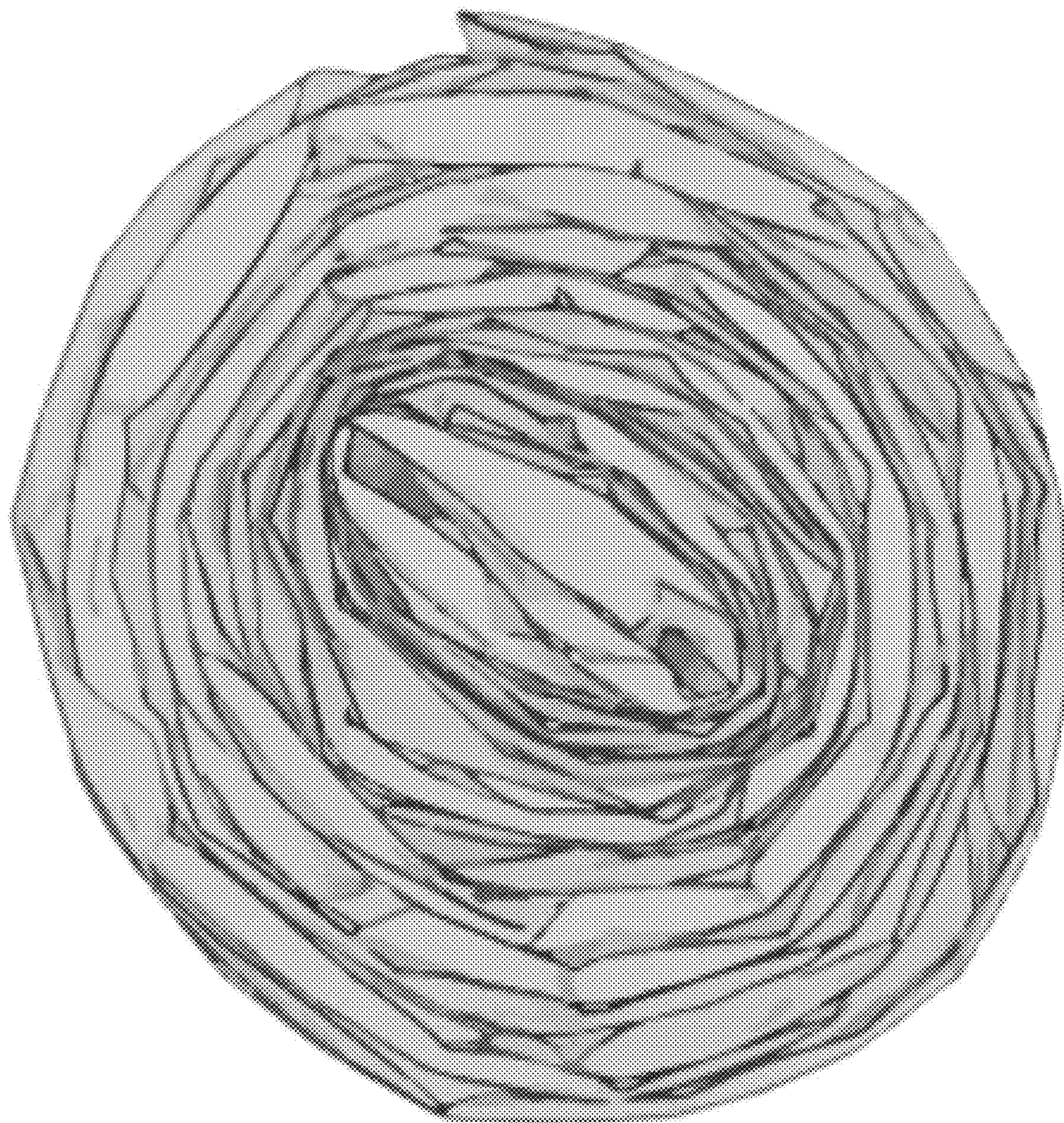

26.1

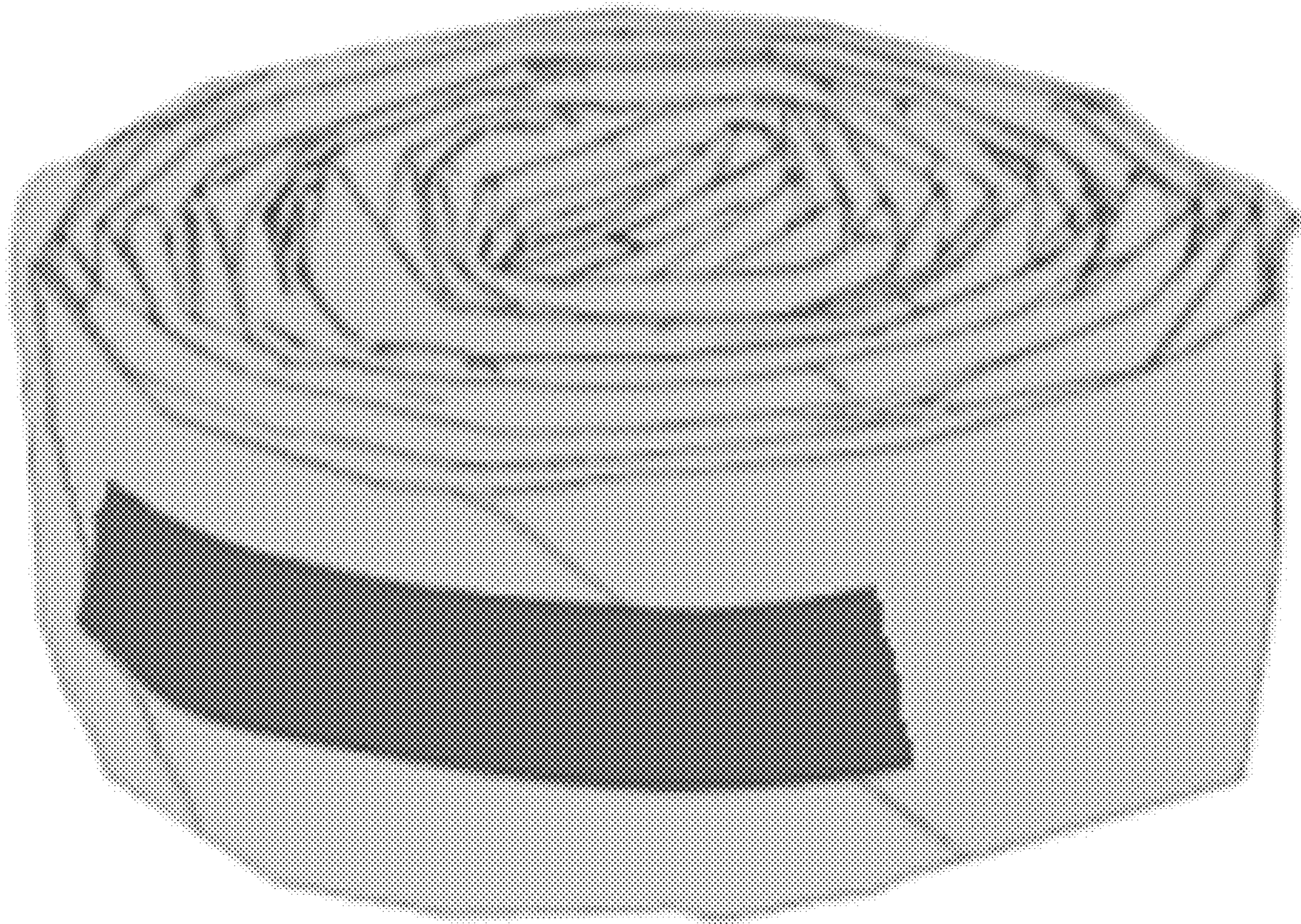

26.2

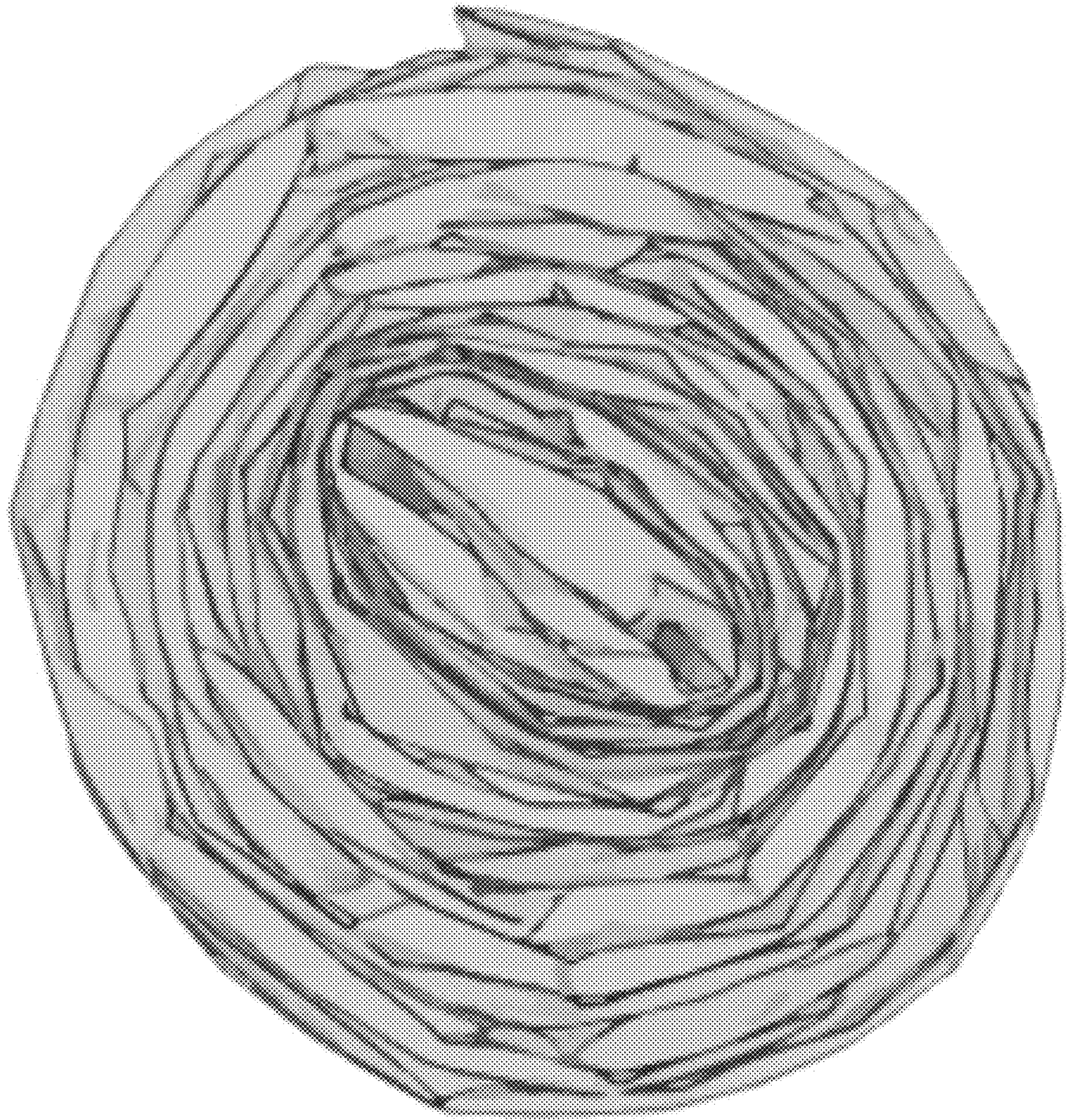

27.1

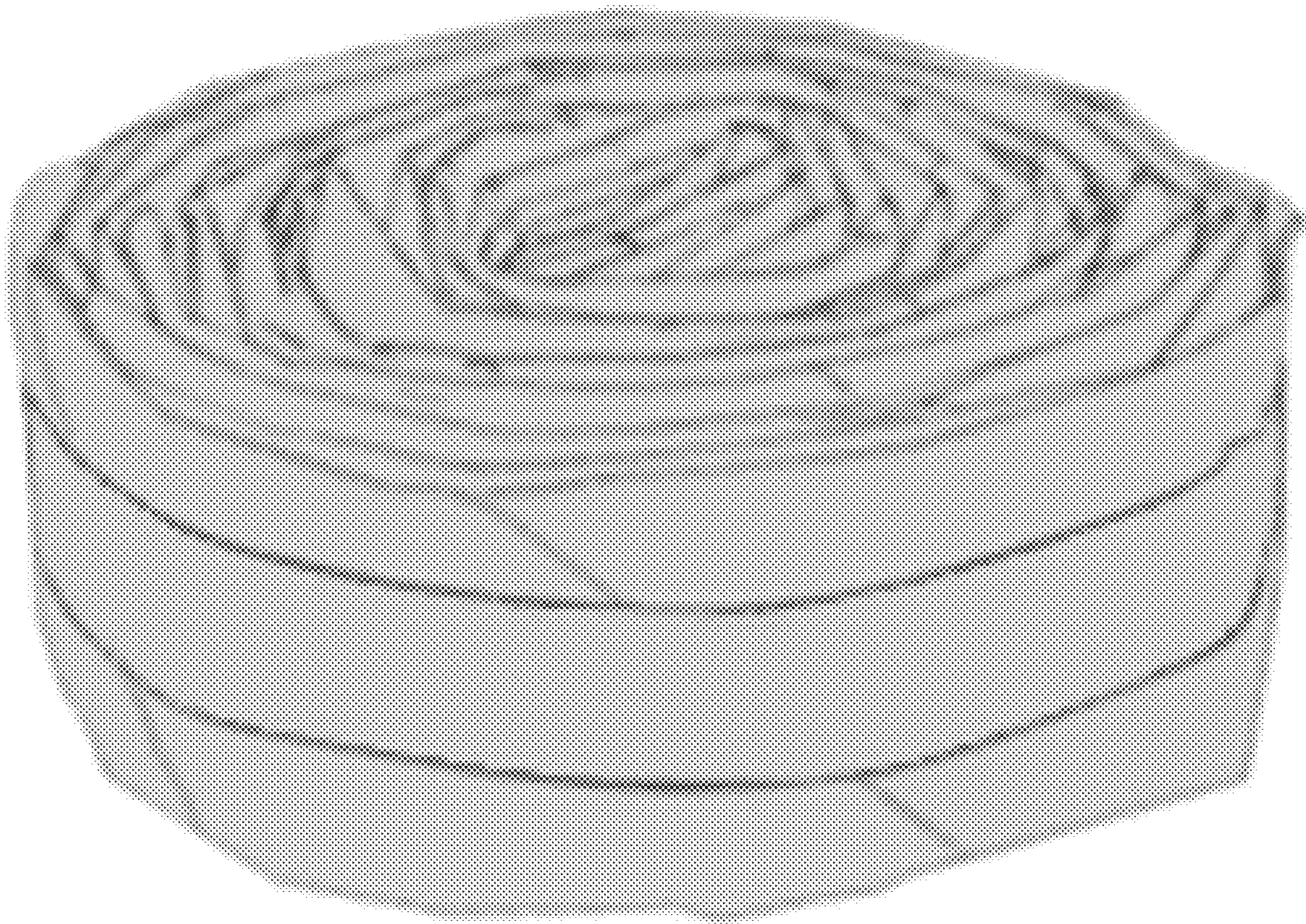

27.2

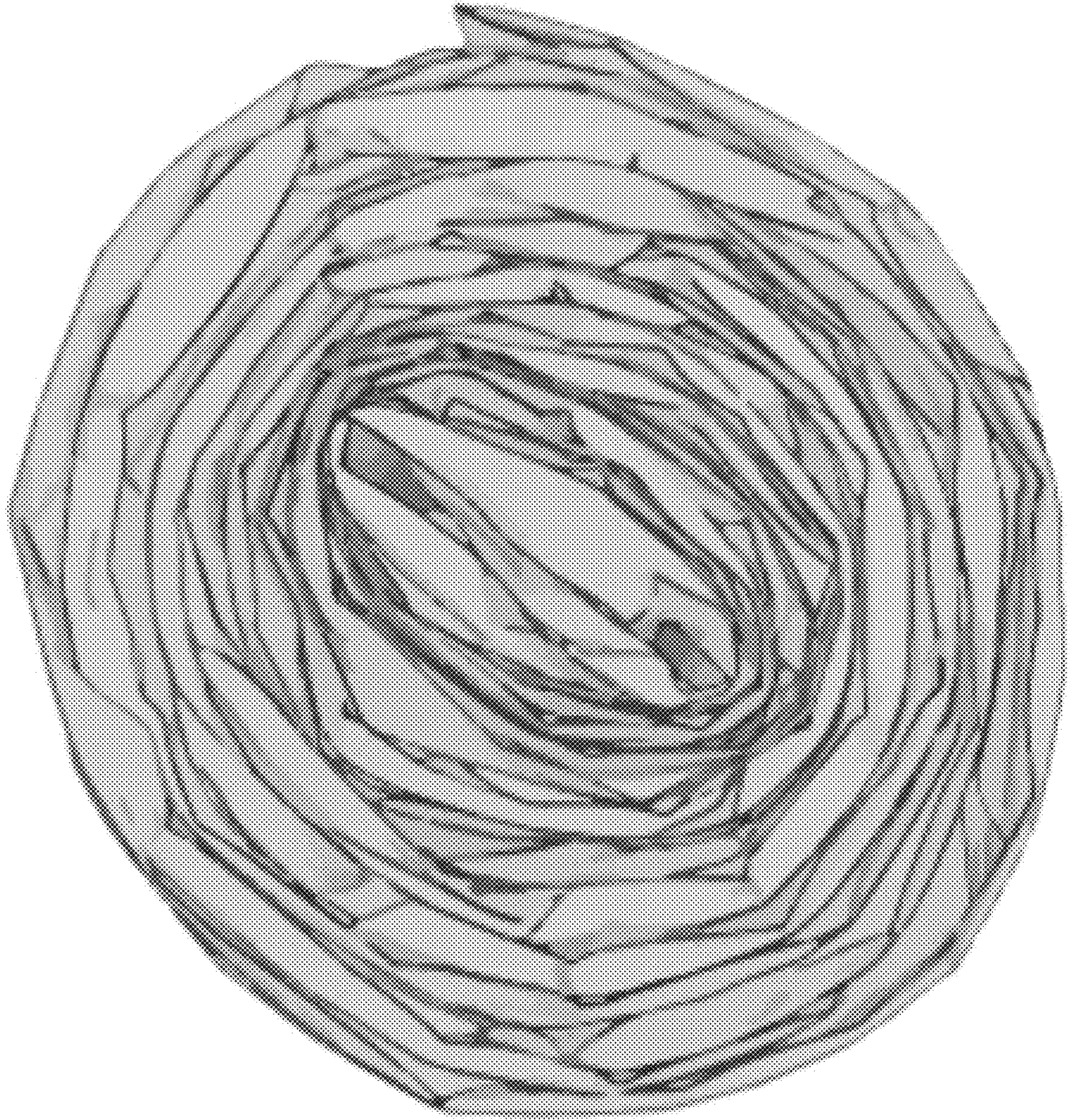

28.1

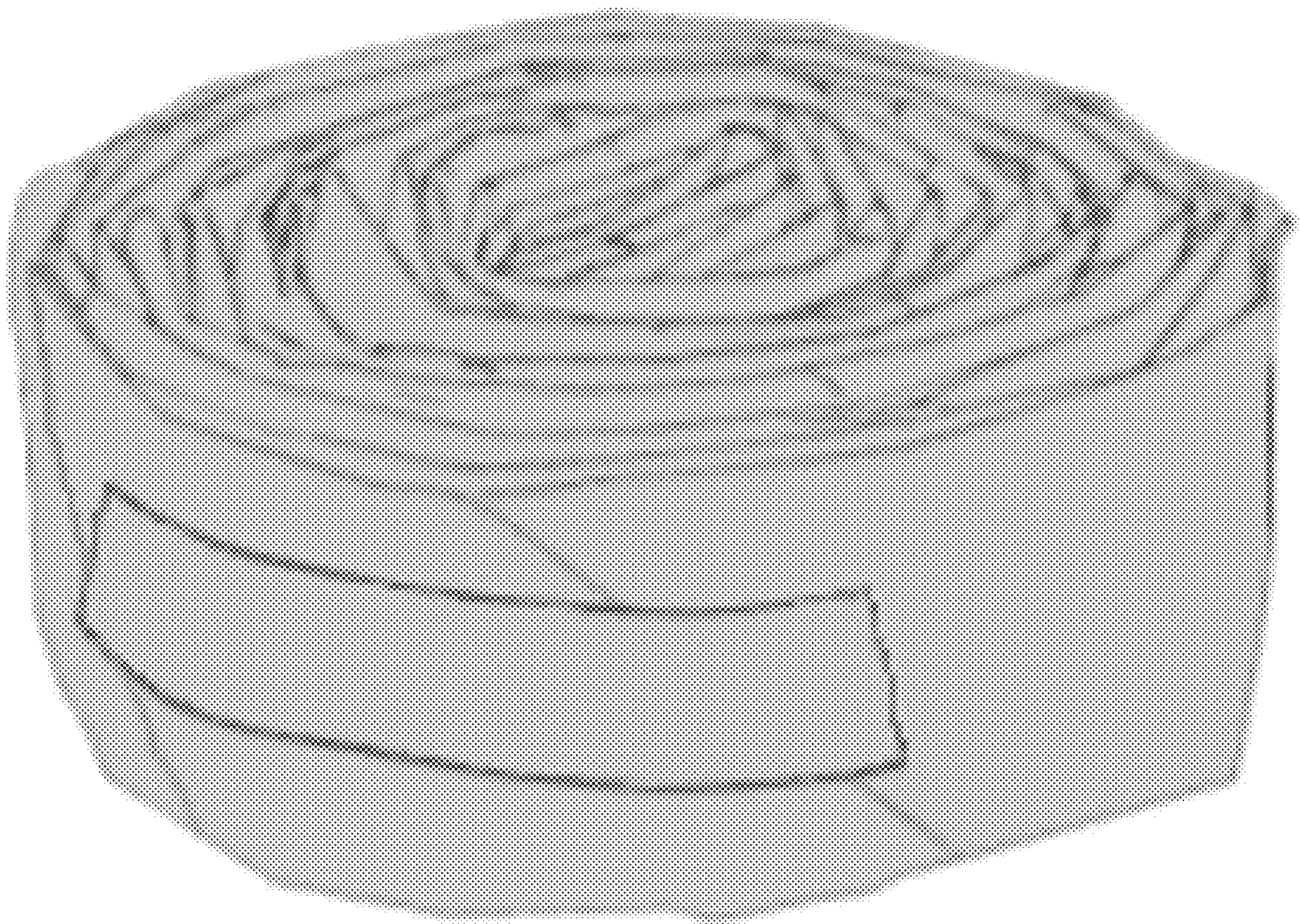

28.2

