



US00D934678S

(12) **United States Design Patent**  
**Eriksson-Ahuja**

(10) **Patent No.:** **US D934,678 S**  
(45) **Date of Patent:** **\*\* Nov. 2, 2021**

(54) **TIN FOR PACKAGING PURPOSES**

*Primary Examiner* — Keli L Hill

(71) Applicant: **Sascha Salomonowitz**, Vienna (AT)

(57) **CLAIM**

(72) Inventor: **Åsa Eriksson-Ahuja**, Vienna (AT)

The ornamental design for a tin for packaging purposes, as shown and described.

(\*\*) Term: **15 Years**

(21) Appl. No.: **35/509,584**

(22) Filed: **Sep. 28, 2019**

(80) **Hague Agreement Data**

Int. Filing Date: **Sep. 28, 2019**

Int. Reg. No.: **DM/208531**

Int. Reg. Date: **Sep. 28, 2019**

Int. Reg. Pub. Date: **Jun. 12, 2020**

(51) **LOC (13) Cl.** ..... **09-01**

(52) **U.S. Cl.**

USPC ..... **D9/430**

(58) **Field of Classification Search**

USPC ..... D9/500, 516, 530, 537, 539, 549, 551,  
D9/564, 571, 763-783

CPC ..... B21D 51/26; B21D 51/383; B29C 66/71;  
B65D 1/00; B65D 1/02; B65D 1/12;  
B65D 1/14; B65D 1/40; B65D 1/44;  
B65D 1/023; B65D 1/0223; B65D 1/165;  
B65D 1/238; B65D 1/246; B65D 1/253;  
B65D 7/04; B65D 21/0209; B65D  
21/0233; B65D 25/00; B65D 25/28;  
B65D 41/0457; B65D 41/17; B65D  
53/06; B65D 75/56; B65D 79/005; B65D  
2501/0036; B65D 2543/00064; B65D  
2543/00074; B65D

(Continued)

(56) **References Cited**

U.S. PATENT DOCUMENTS

D9,767 S \* 2/1877 Norton ..... D9/782  
D249,624 S \* 9/1978 Solomon ..... D7/391

(Continued)

**DESCRIPTION**

- 2.-5. Tin for packaging purposes
- 2.1 is a perspective view shown closed.
- 2.2 is a perspective view of the top lid interior.
- 2.3 is an exploded top plan view.
- 2.4 is an exploded front elevation view.
- 2.5 is an exploded perspective view of the top lid interior.
- 2.6 is an exploded perspective view of the interior body portion.
- 2.7 is an exploded perspective view.
- 3.1 is a perspective view of another embodiment shown closed.
- 3.2 is a perspective view of the top lid interior.
- 3.3 is an exploded perspective view of the top lid interior.
- 3.4 is an exploded top plan view.
- 3.5 is an exploded front elevation view.
- 3.6 is an exploded perspective view of the interior body portion.
- 3.7 is an exploded perspective view.
- 4.1 is a perspective view of another embodiment shown closed.
- 4.2 is an exploded top plan view.
- 4.3 is perspective view of the top lid interior.
- 4.4 is an exploded perspective view of the top lid interior.
- 4.5 is an exploded perspective view.
- 4.6 is an exploded front elevation view.
- 4.7 is an exploded perspective view of the interior body portion.
- 5.1 is a perspective view of another embodiment shown closed.
- 5.2 is an exploded perspective view.
- 5.3 is perspective view of the top lid interior.
- 5.4 is an exploded top plan view.
- 5.5 is an exploded perspective view of the top lid interior.
- 5.6 is an exploded front elevation view.

(Continued)

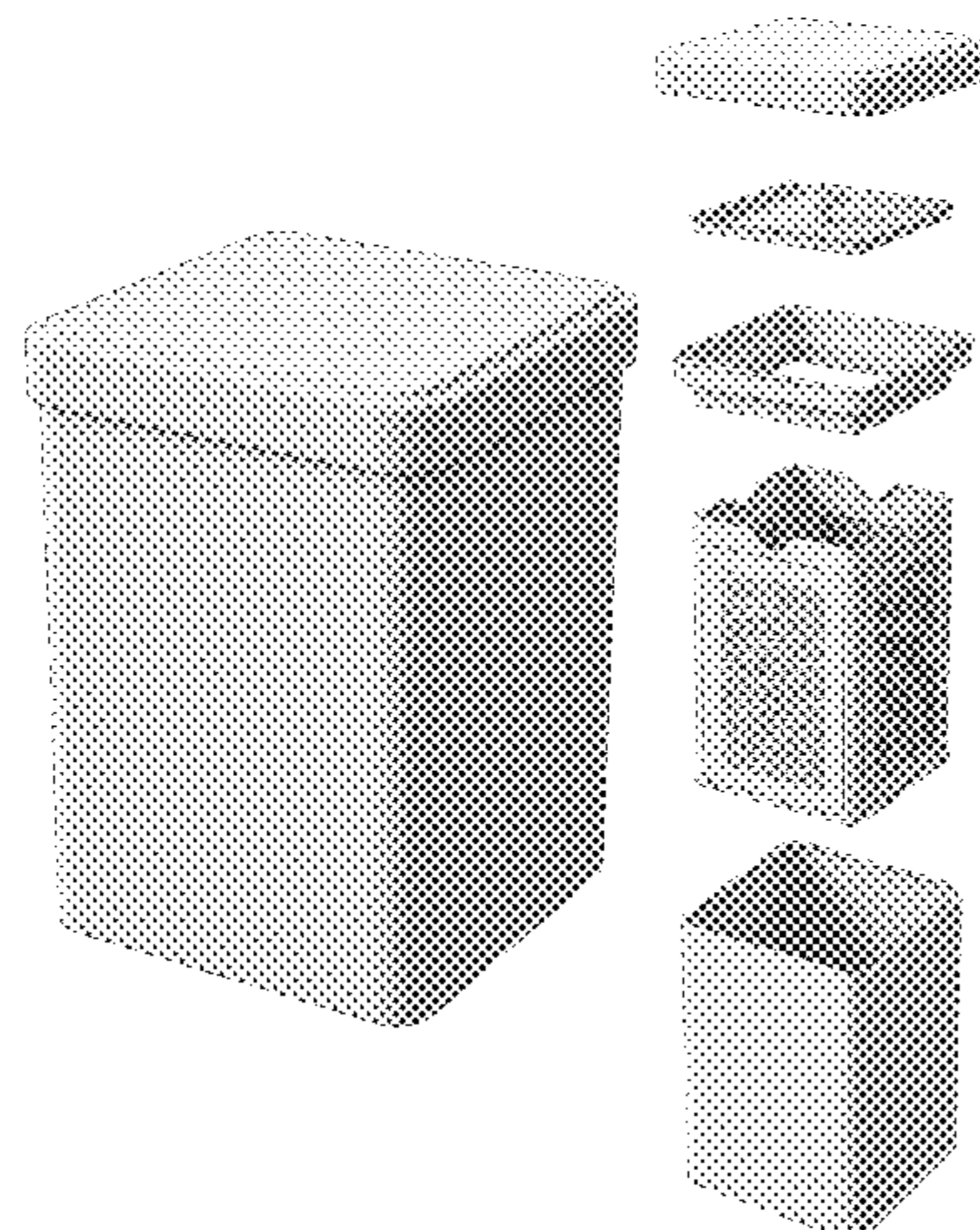

5.7 is an exploded perspective view of the interior body portion.

**1 Claim, 28 Drawing Sheets**

(58) **Field of Classification Search**

CPC ..... 2543/00083; B65D 2543/00092; B65D  
2543/00101; B65D 2543/00111; Y10T  
29/49826

See application file for complete search history.

(56) **References Cited**

U.S. PATENT DOCUMENTS

4,850,506 A \* 7/1989 Heaps, Jr. .... B65D 77/061  
229/117.3  
D385,186 S \* 10/1997 Fildan ..... D9/430  
D463,278 S \* 9/2002 Weinstein ..... D9/430  
D464,882 S \* 10/2002 Weinstein ..... D9/430

D464,883 S \* 10/2002 Weinstein ..... D9/430  
D465,155 S \* 11/2002 Weinstein ..... D9/430  
D465,414 S \* 11/2002 Weinstein ..... D9/430  
D472,467 S \* 4/2003 Weinstein ..... D9/430  
D525,532 S \* 7/2006 Glass ..... D9/559  
D529,391 S \* 10/2006 Glass ..... D9/559  
D592,966 S \* 5/2009 Nissen ..... D9/560  
D605,505 S \* 12/2009 Shearsby ..... D9/655  
D682,706 S \* 5/2013 Weil ..... D9/560  
D695,620 S \* 12/2013 Karekar ..... D9/529  
D698,242 S \* 1/2014 Hartman ..... B65D 77/061  
D9/430  
D849,530 S \* 5/2019 Fremgen ..... D9/430  
D893,997 S \* 8/2020 Ryan ..... B65D 25/14  
D9/430  
2011/0127176 A1 \* 6/2011 Chang ..... B65D 43/162  
206/204  
2012/0118887 A1 \* 5/2012 Portman ..... A47G 19/14  
220/212  
2017/0233140 A1 \* 8/2017 McMunn ..... B65D 25/14  
220/228

\* cited by examiner

2.1

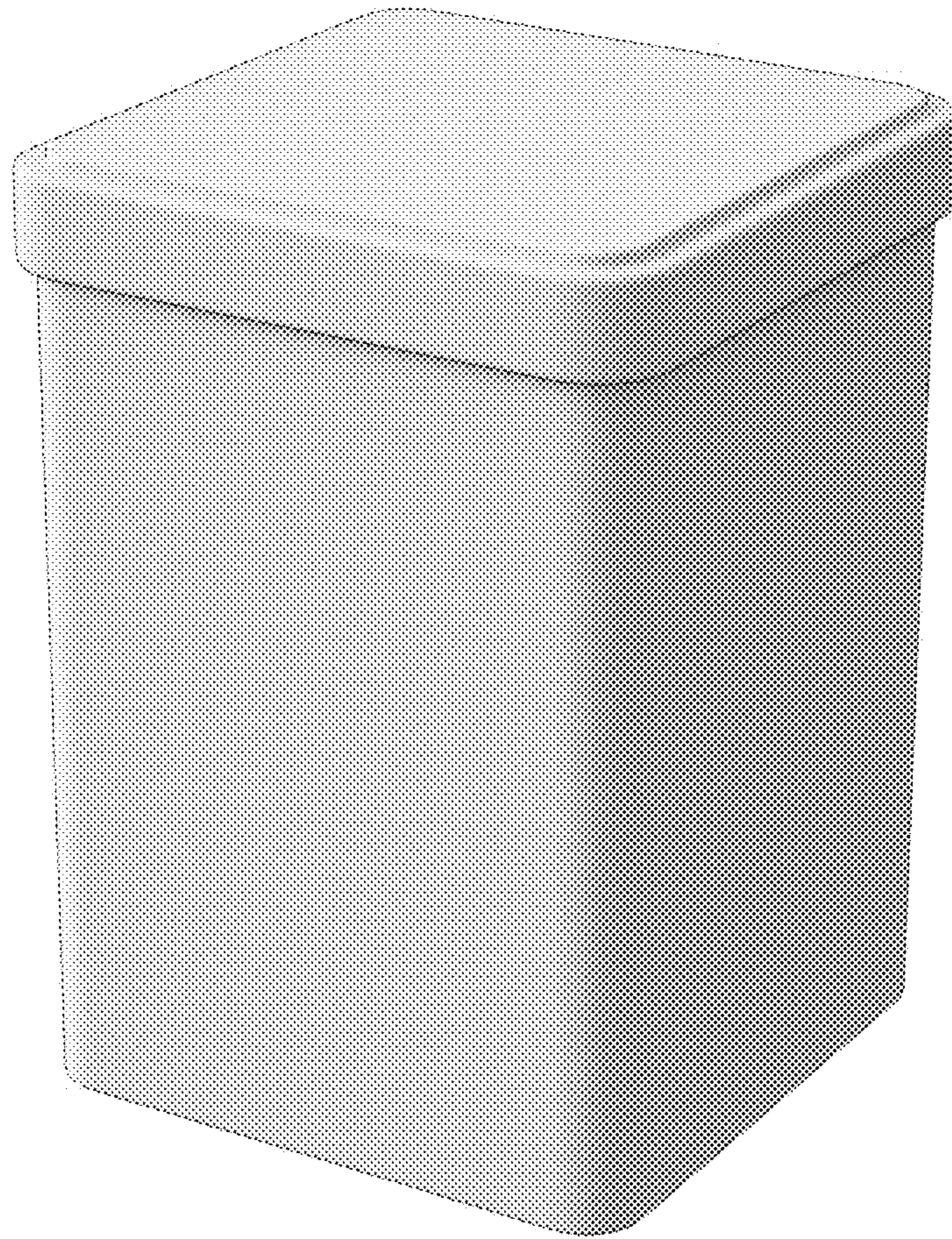

2.2

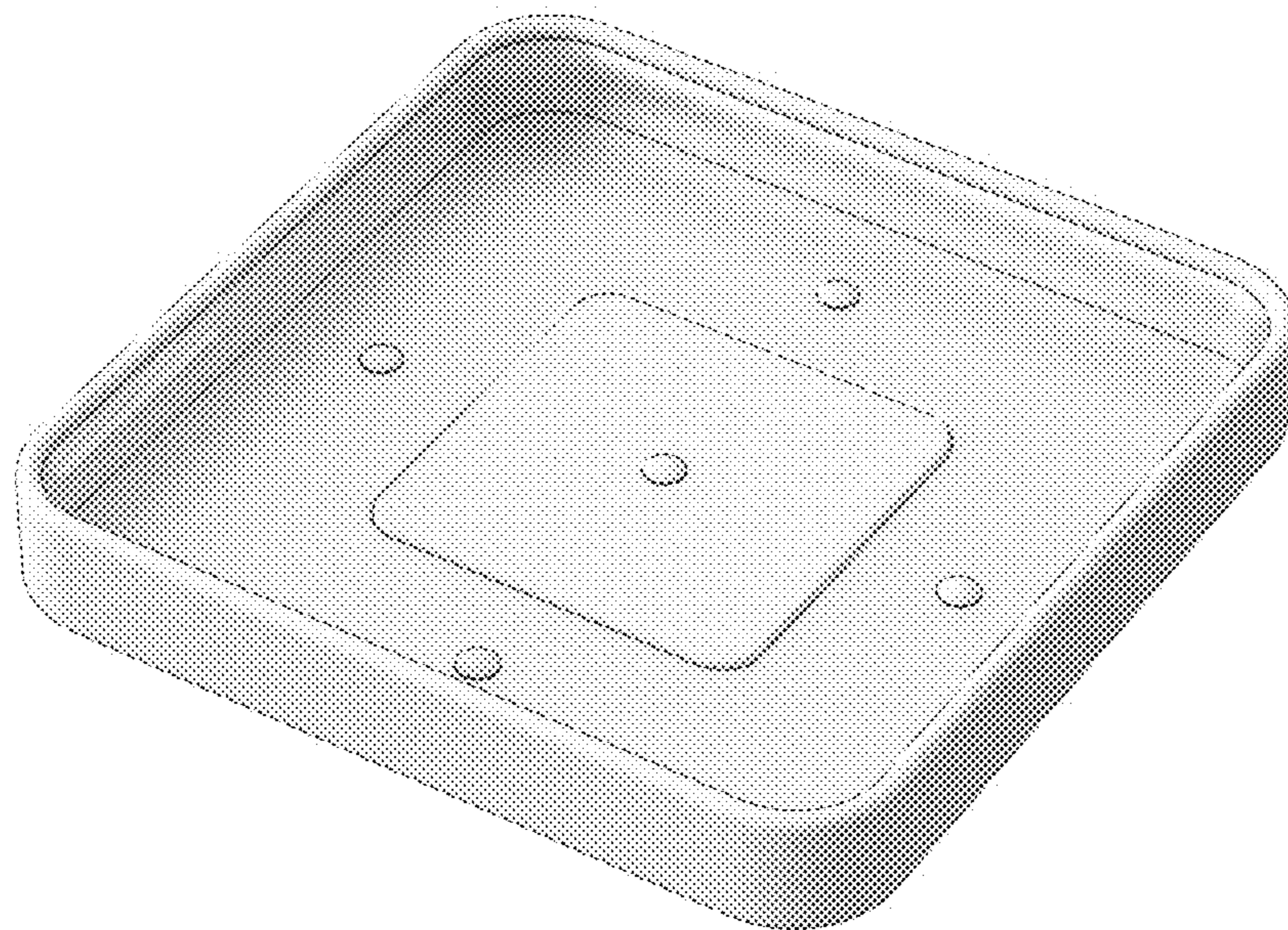

2.3

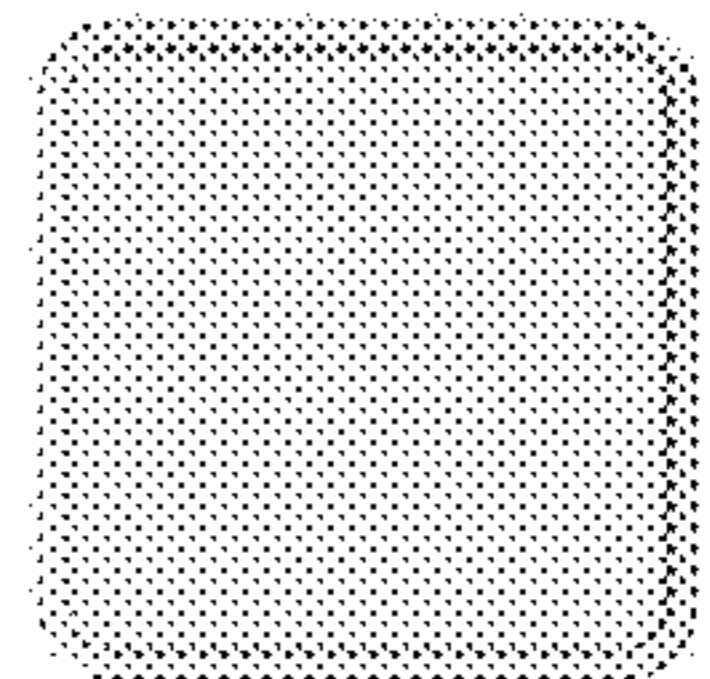
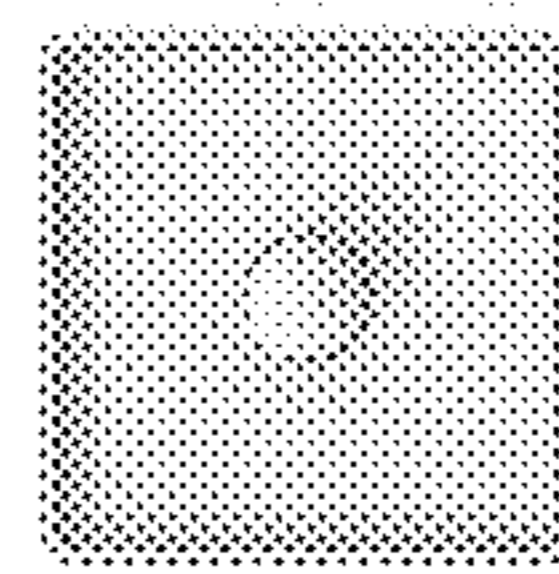
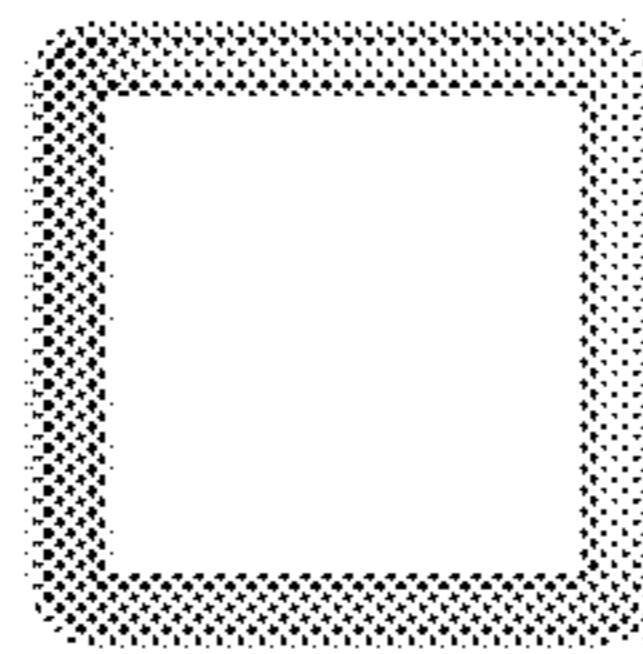
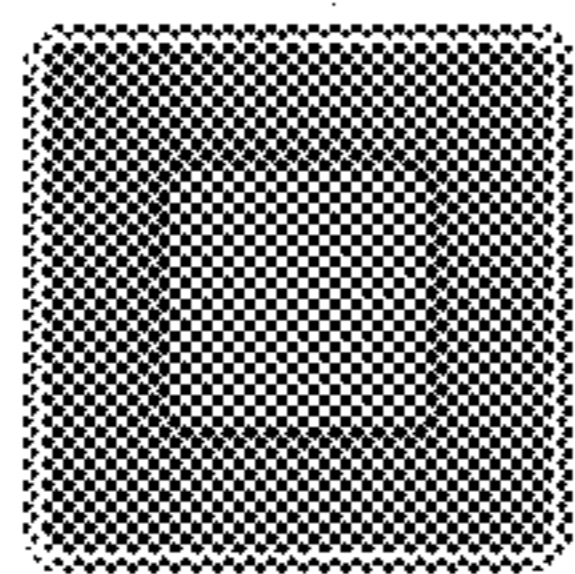
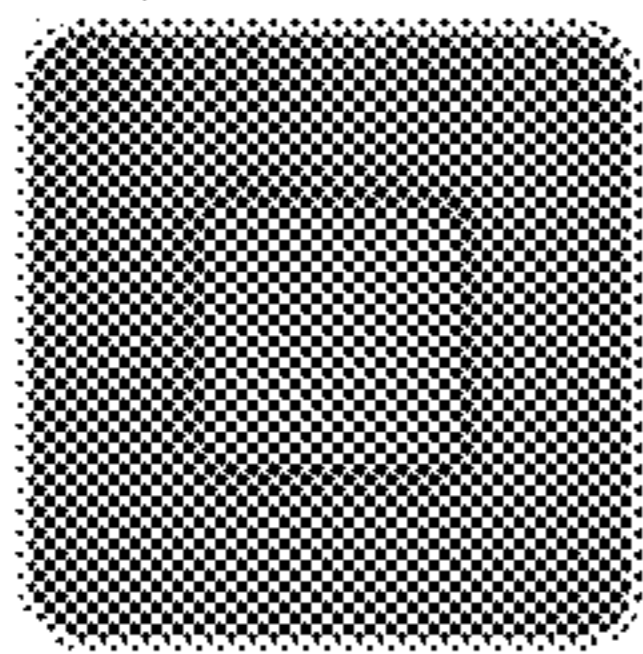

2.4

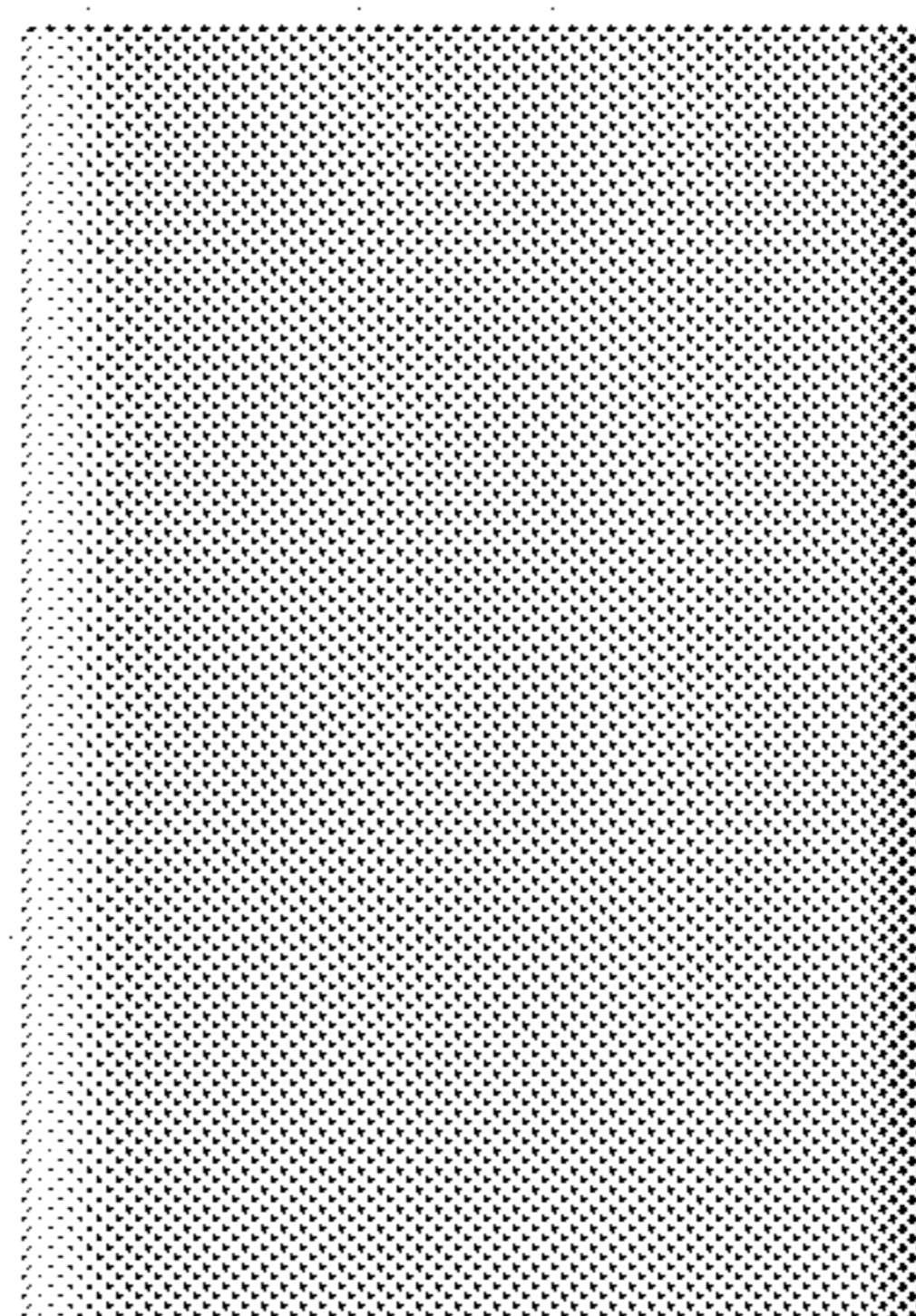
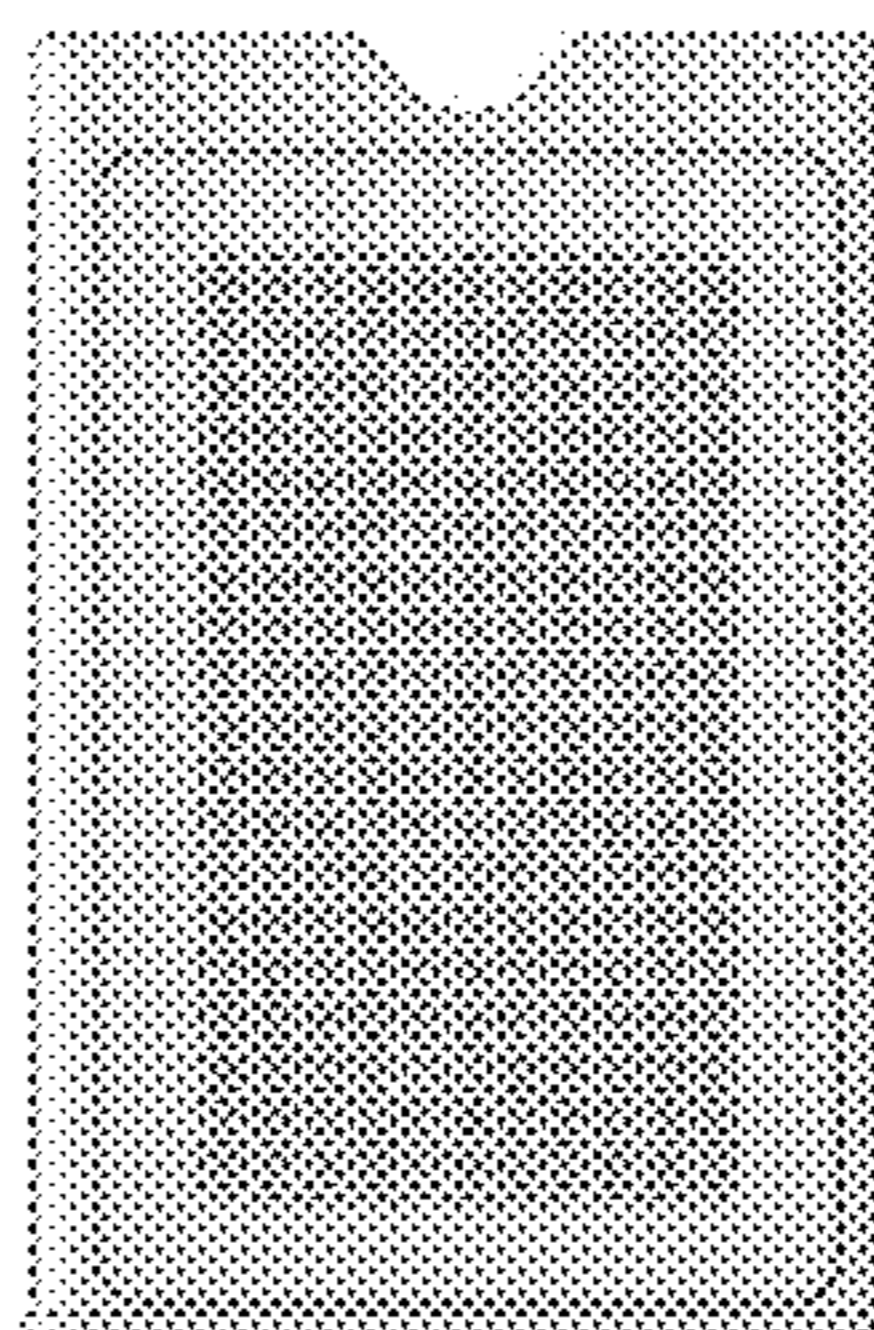
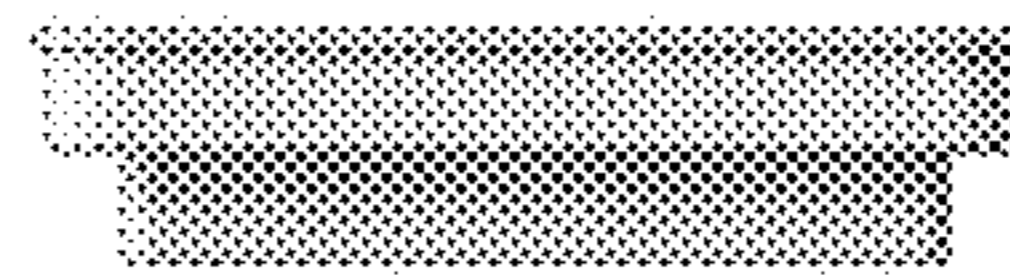
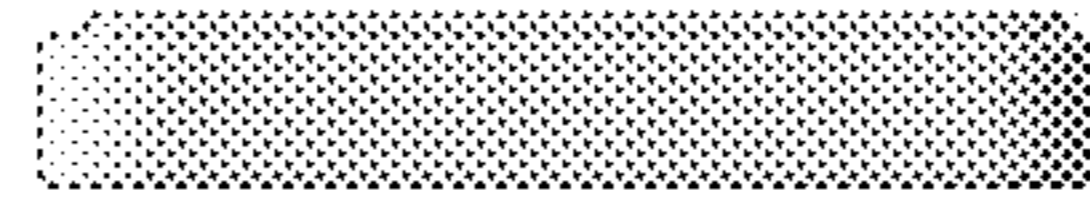

2.5



2.6

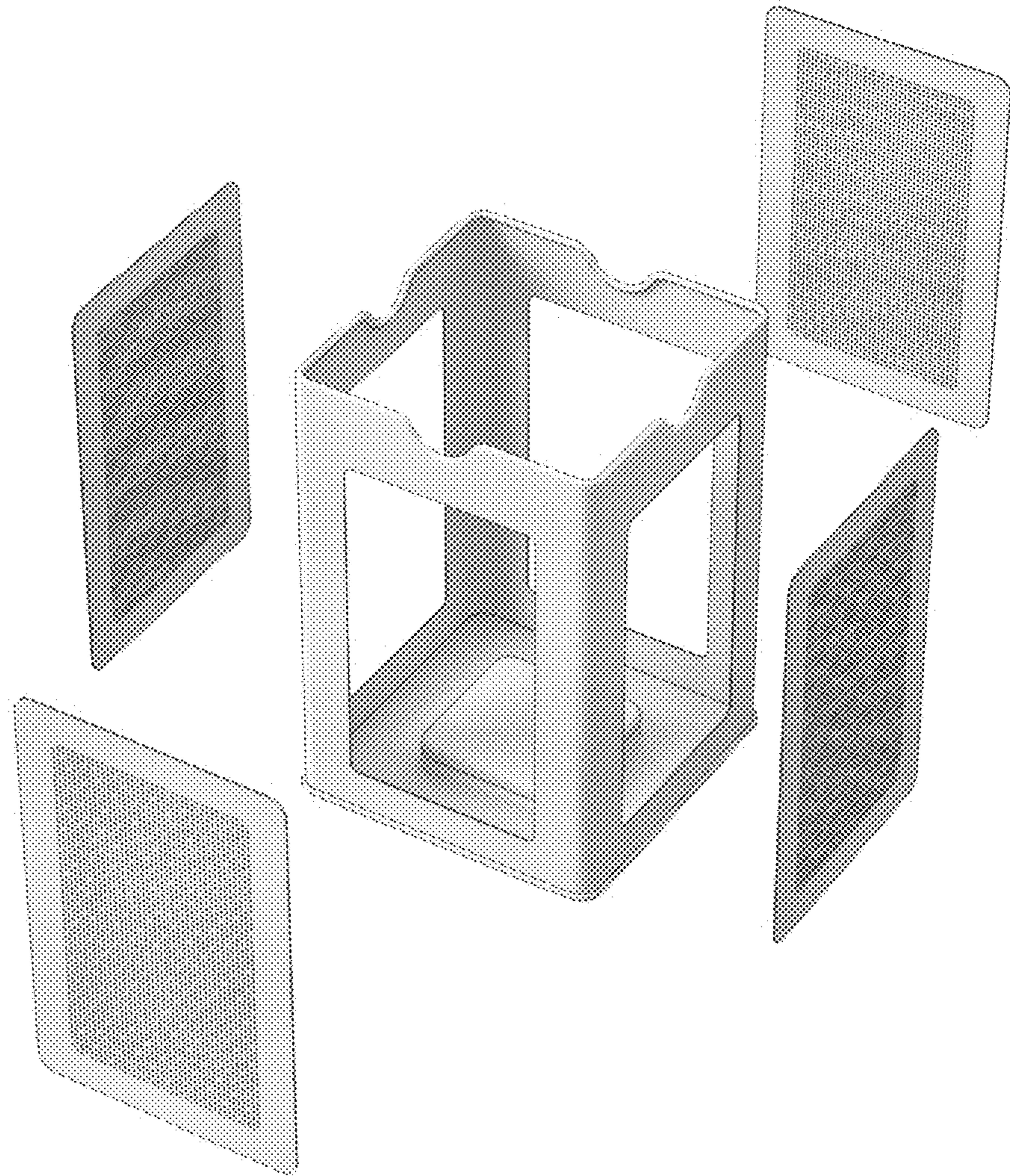



2.7

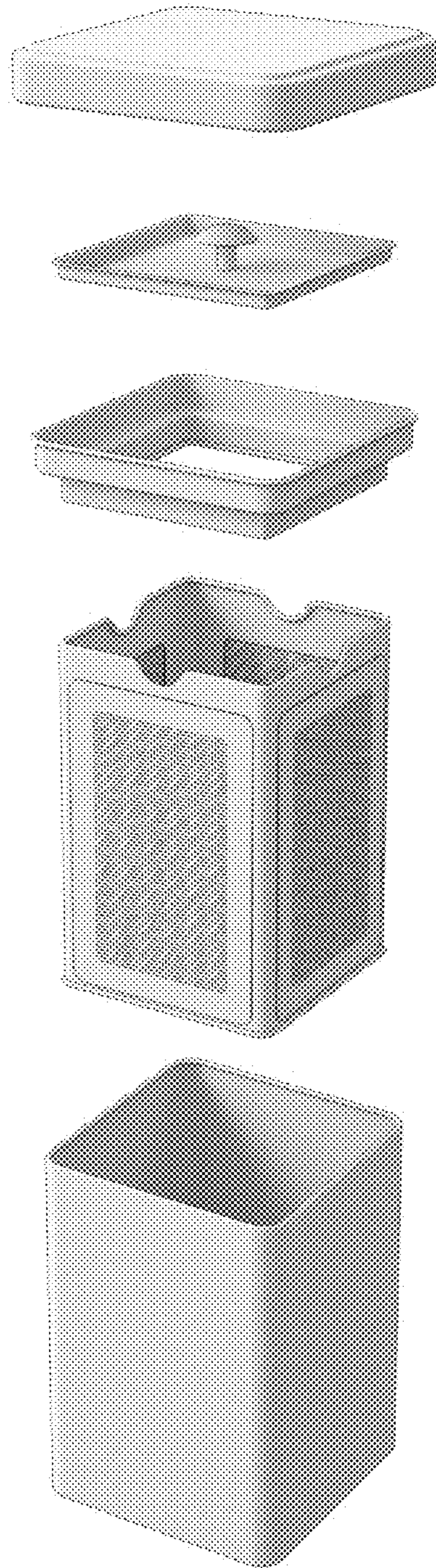

3.1

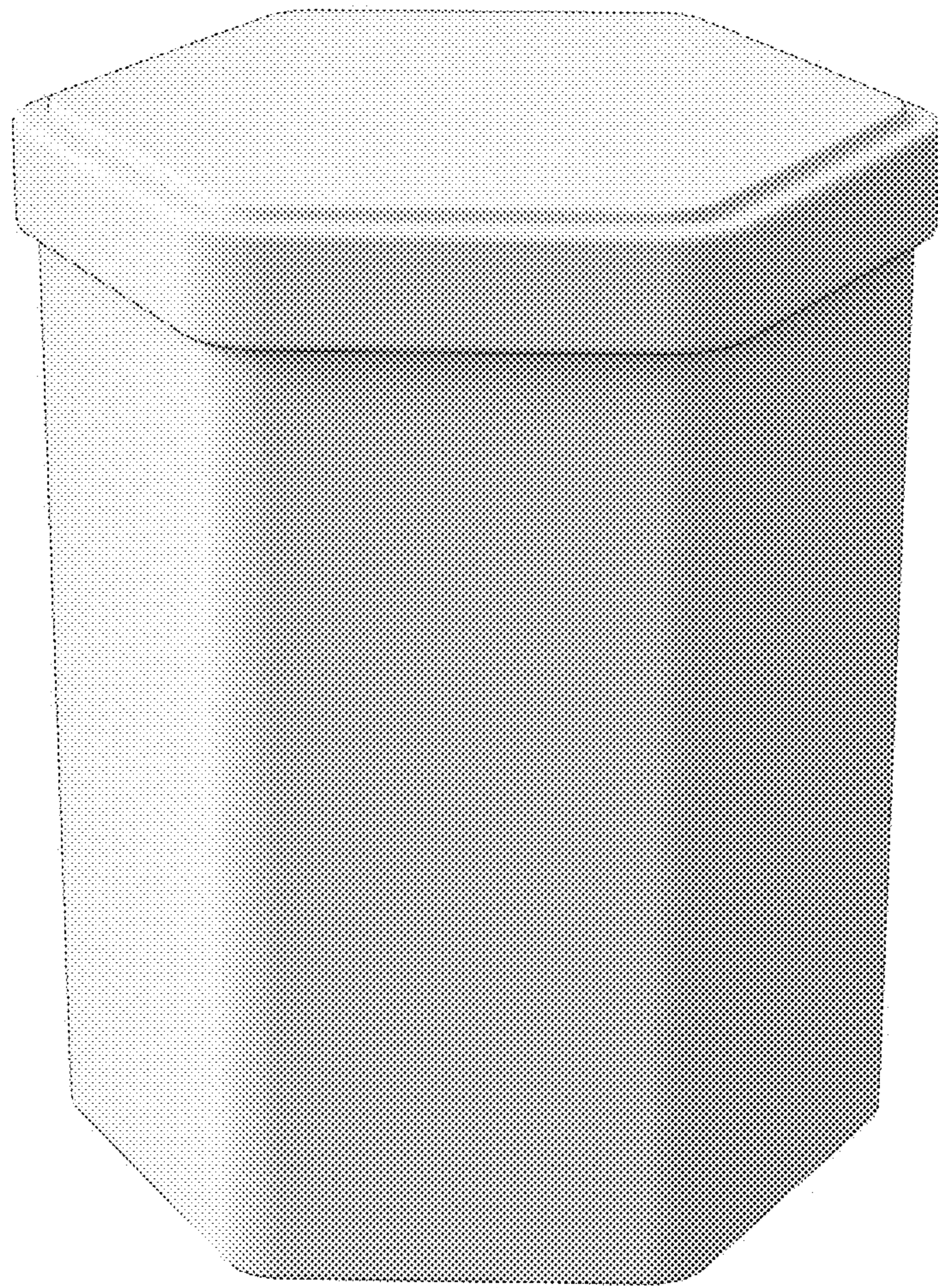

3.2

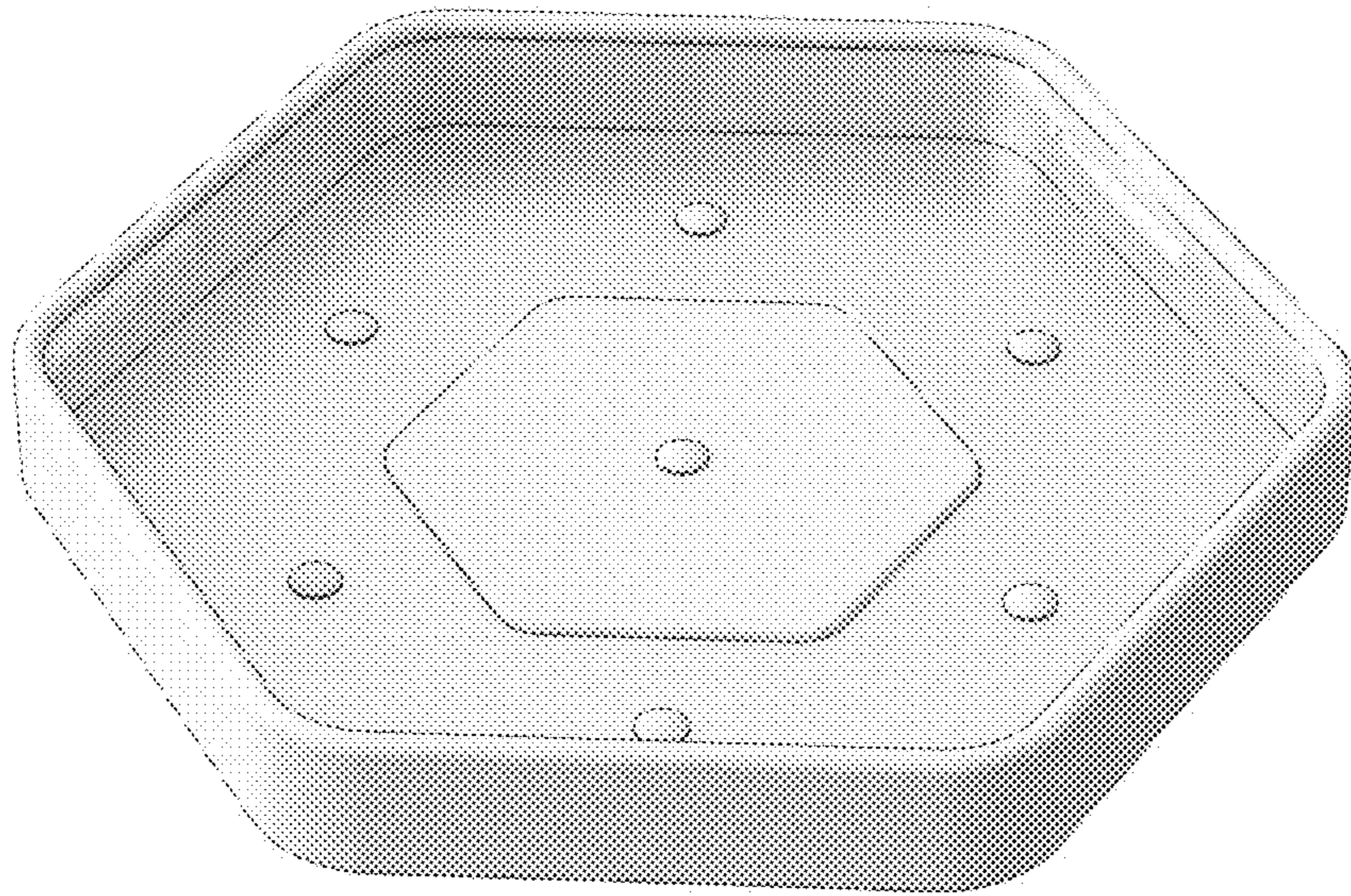

3.3



3.4

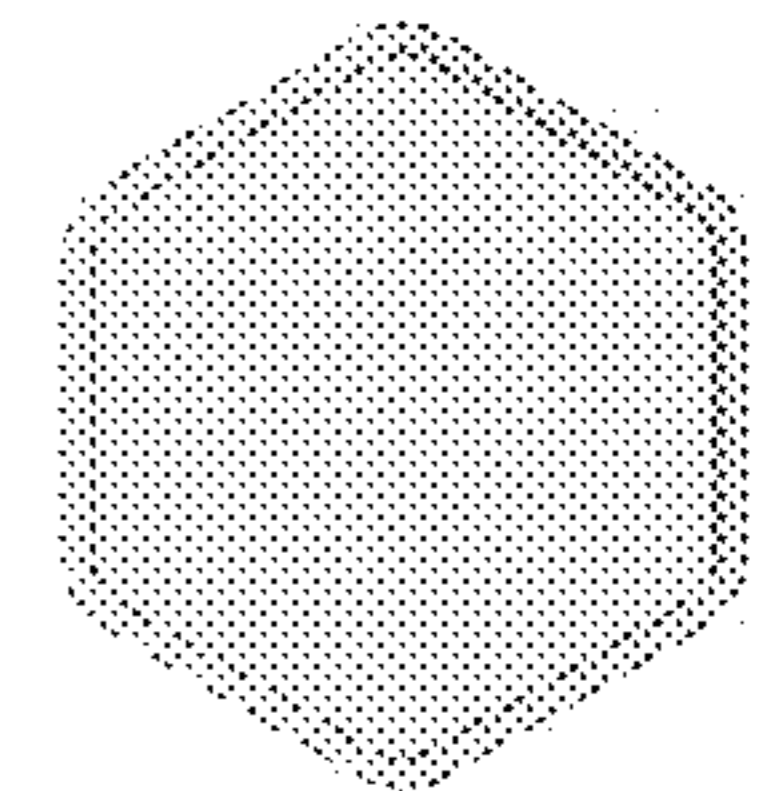
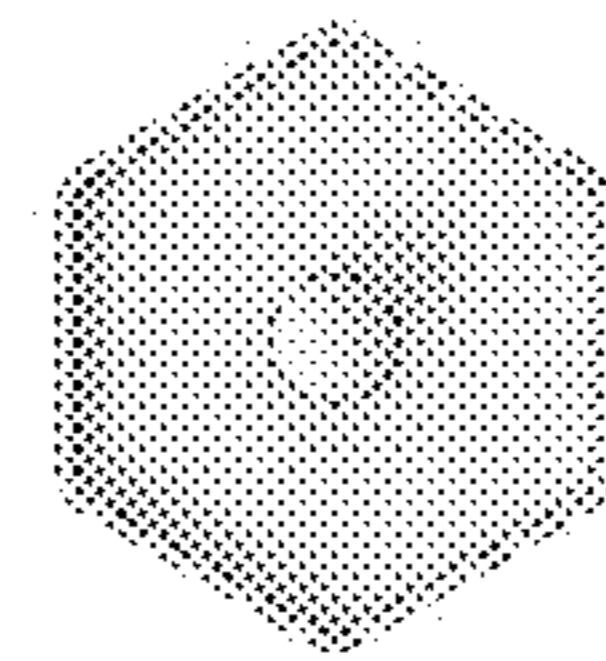
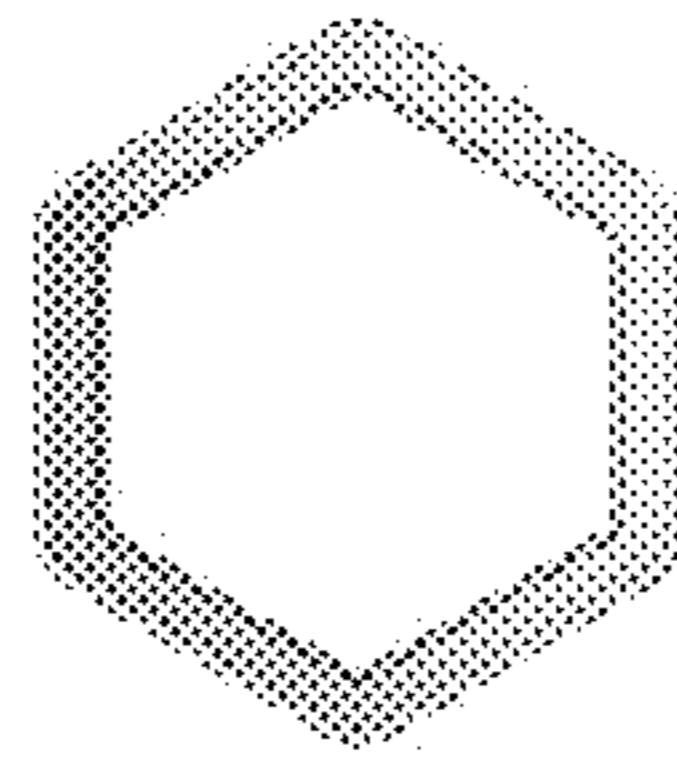
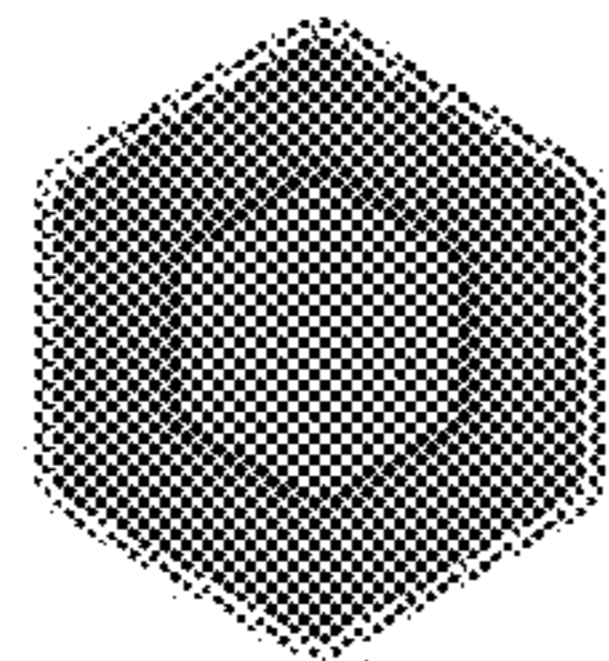
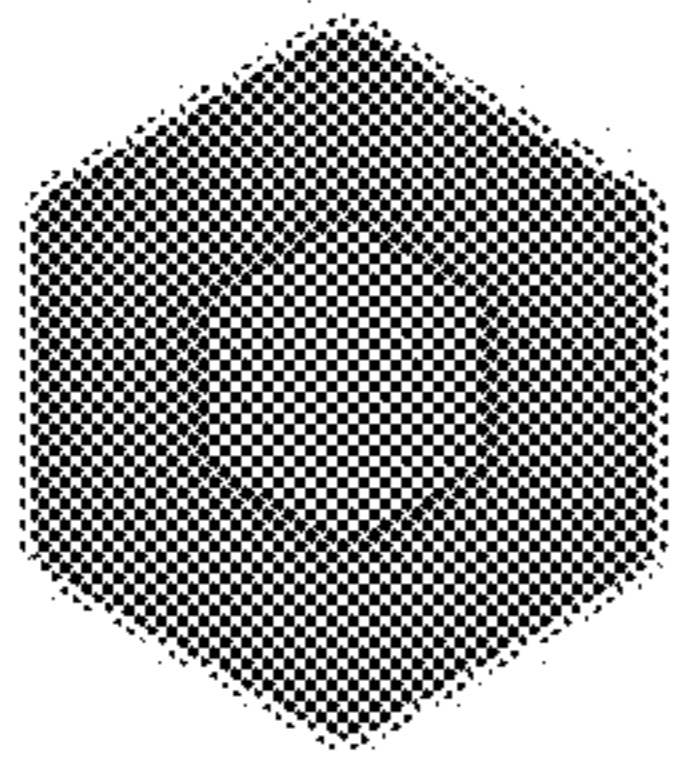

3.5

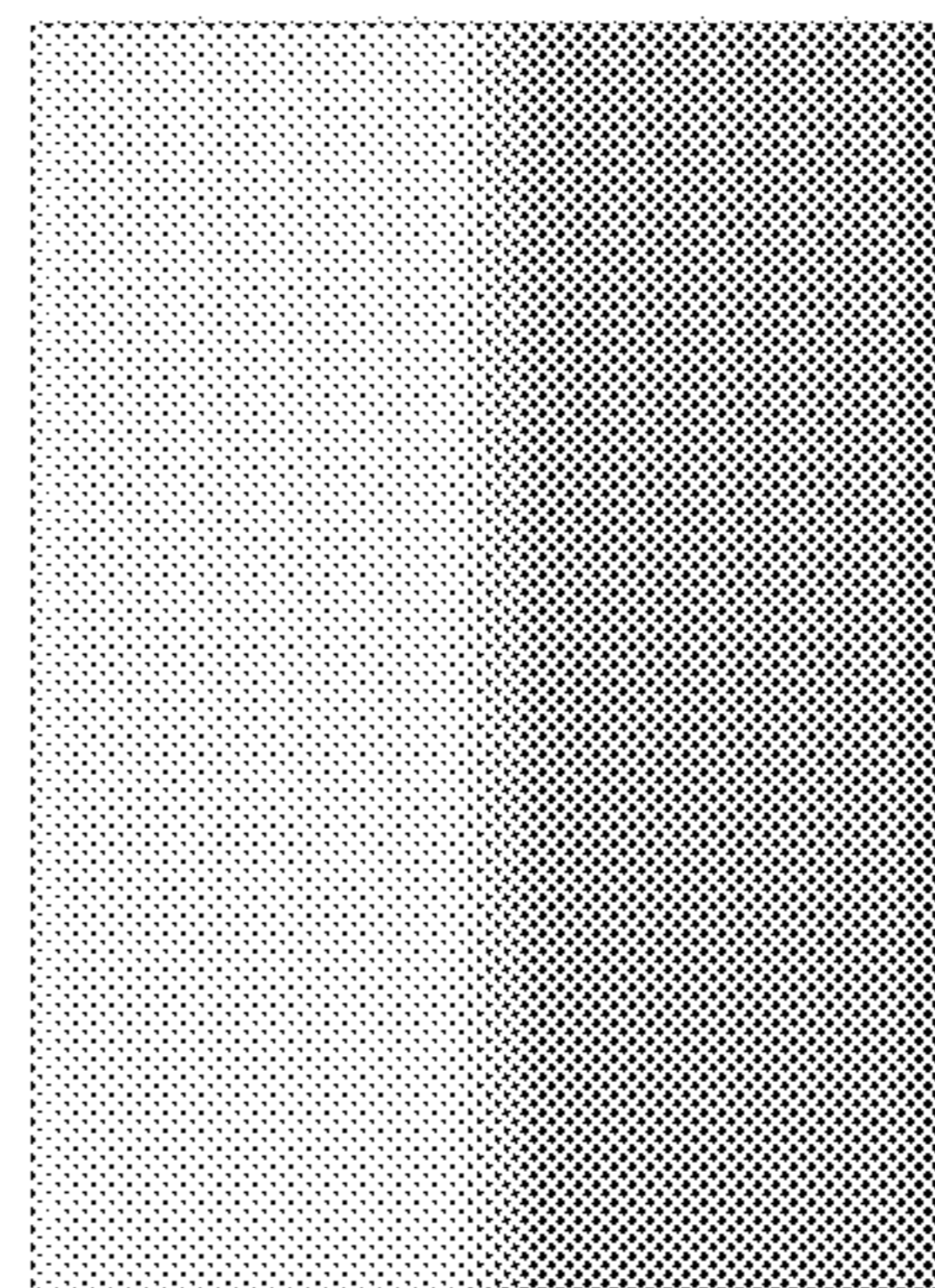
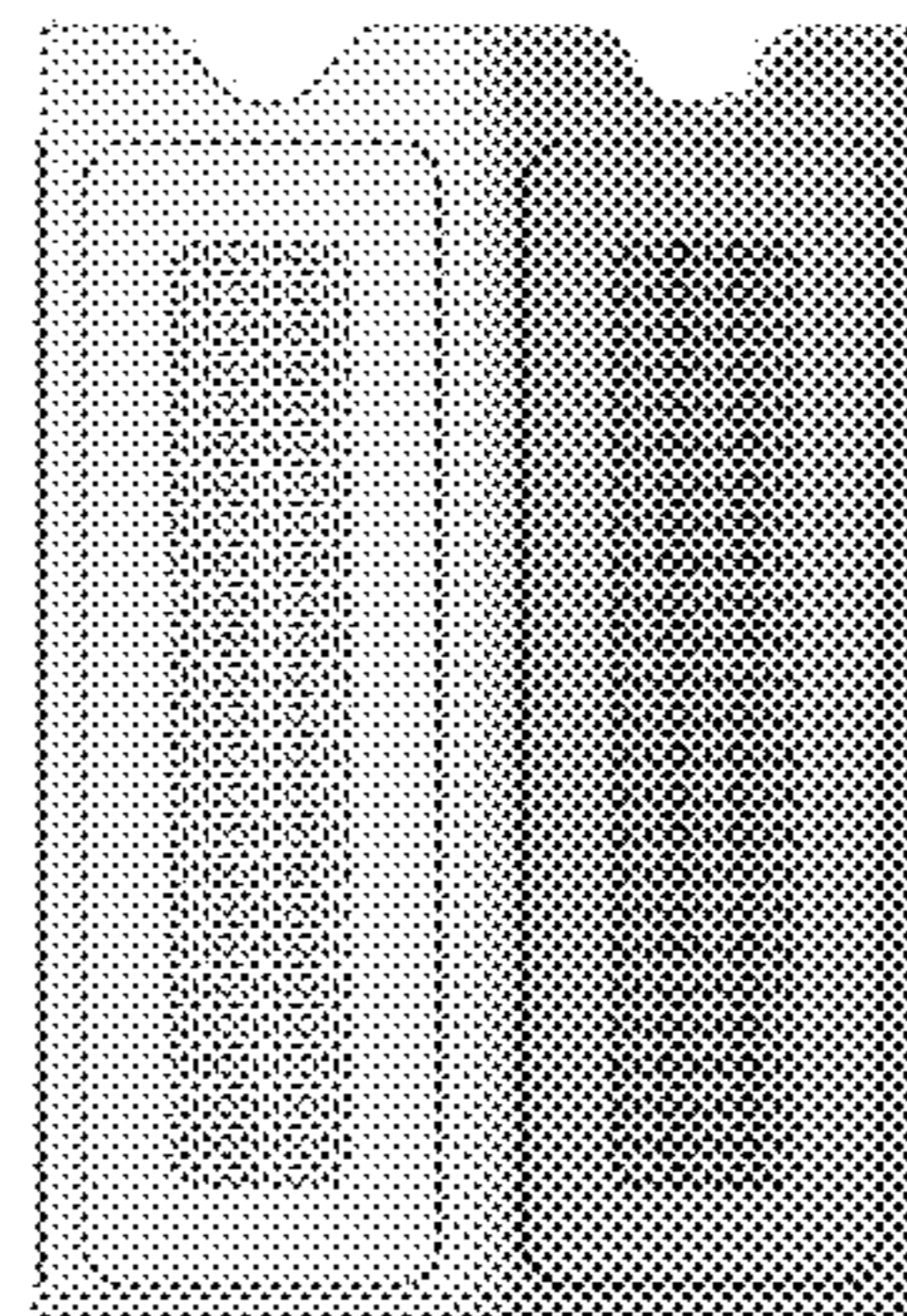
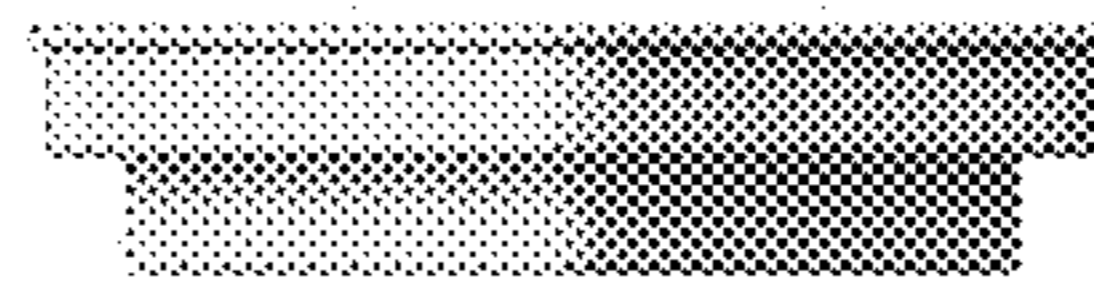
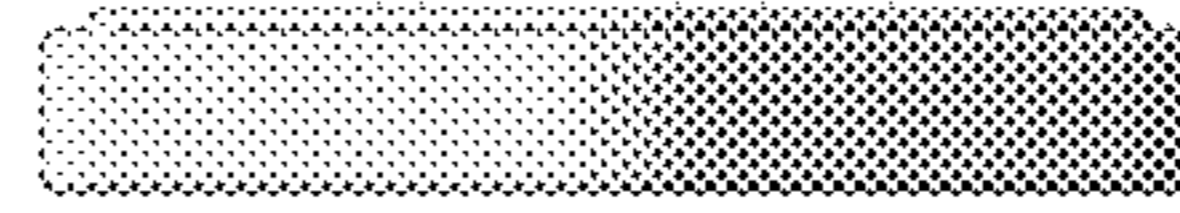

3.6

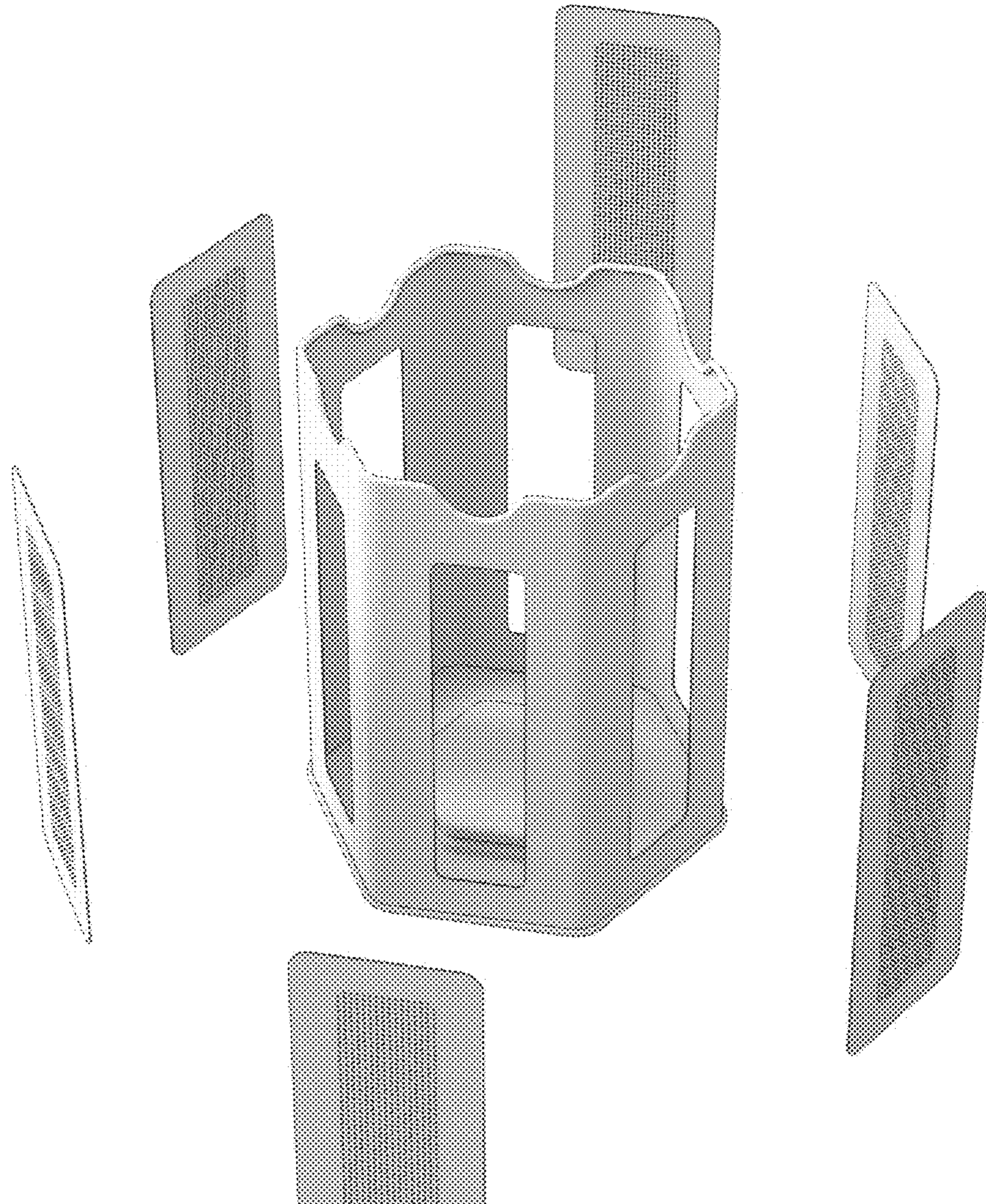

3.7

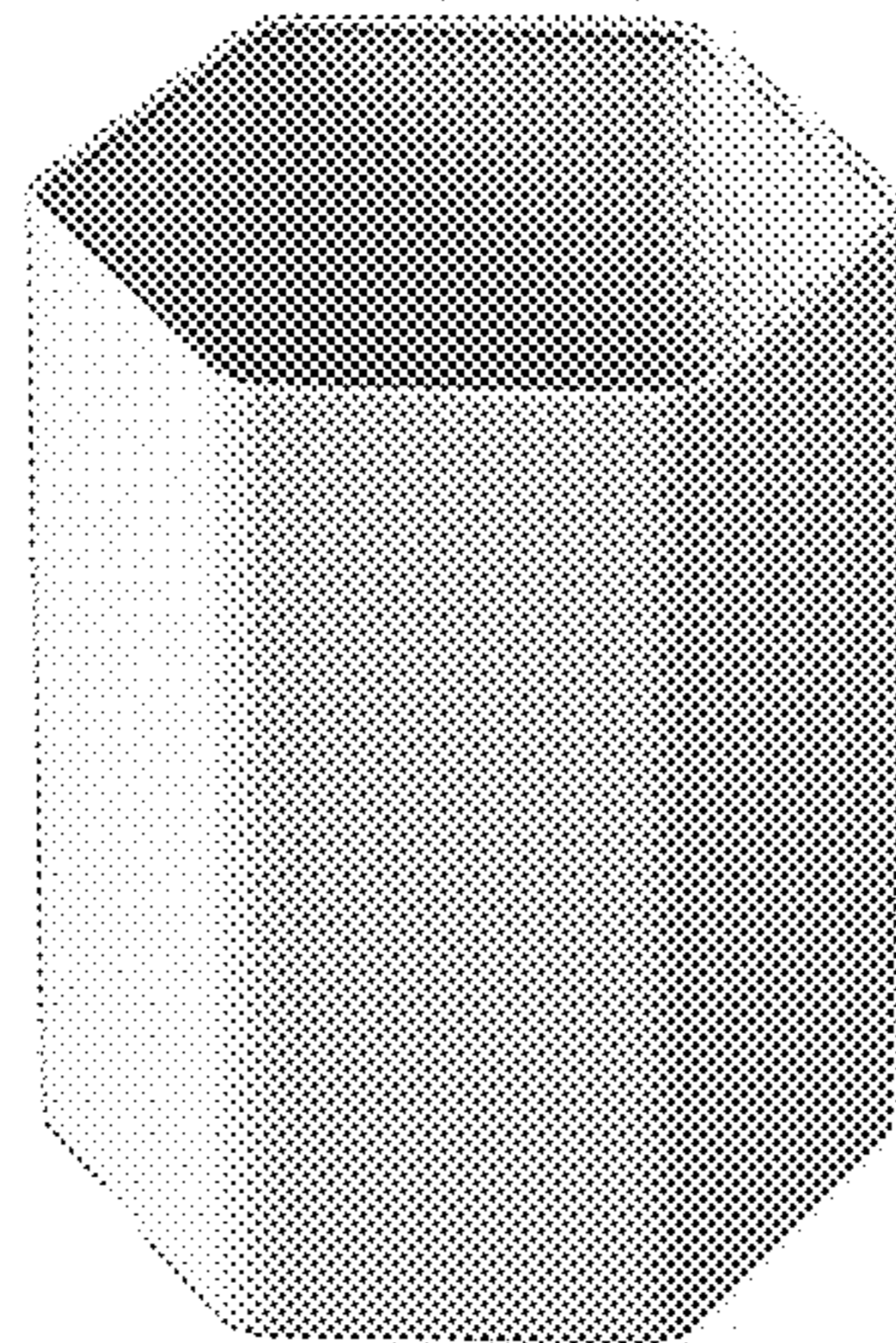
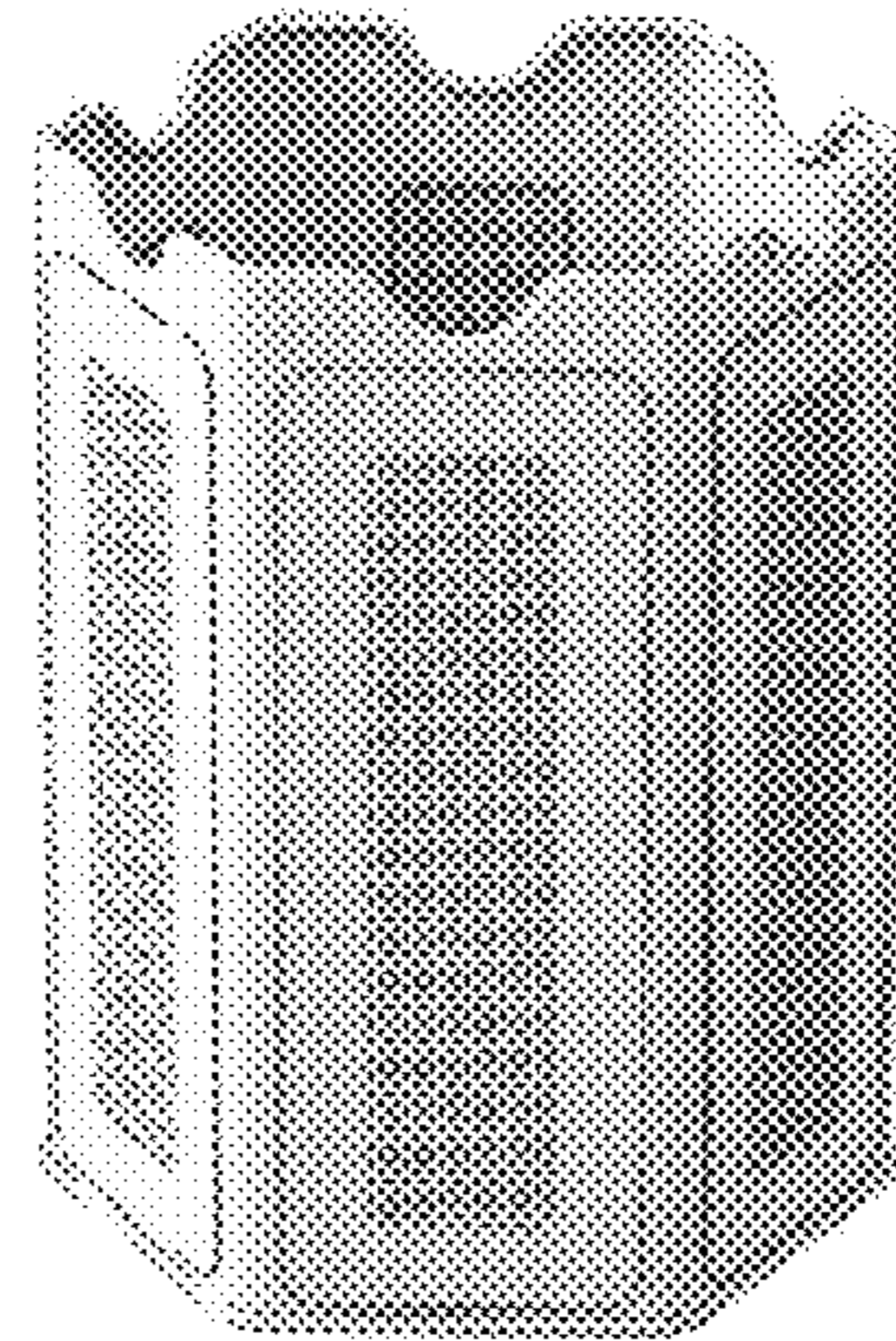
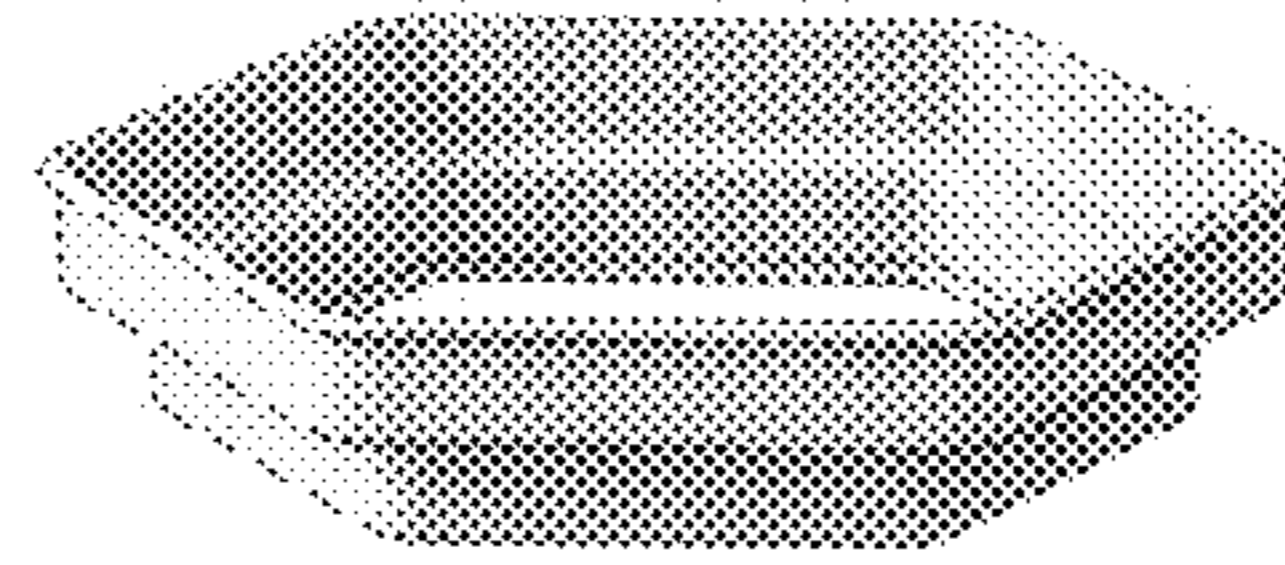
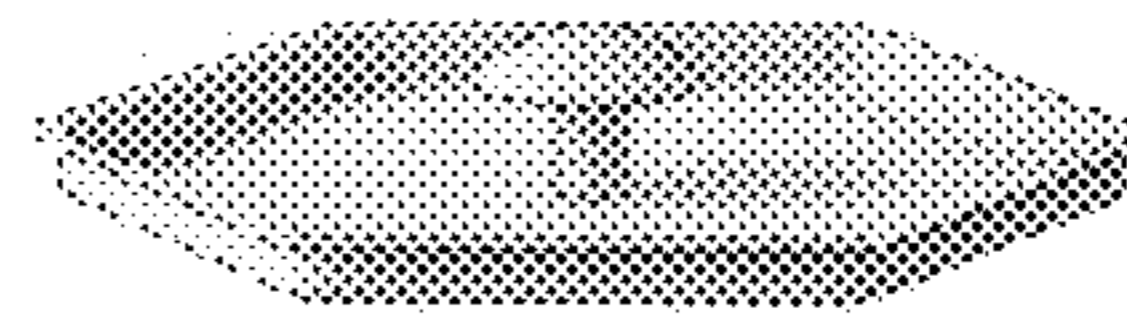
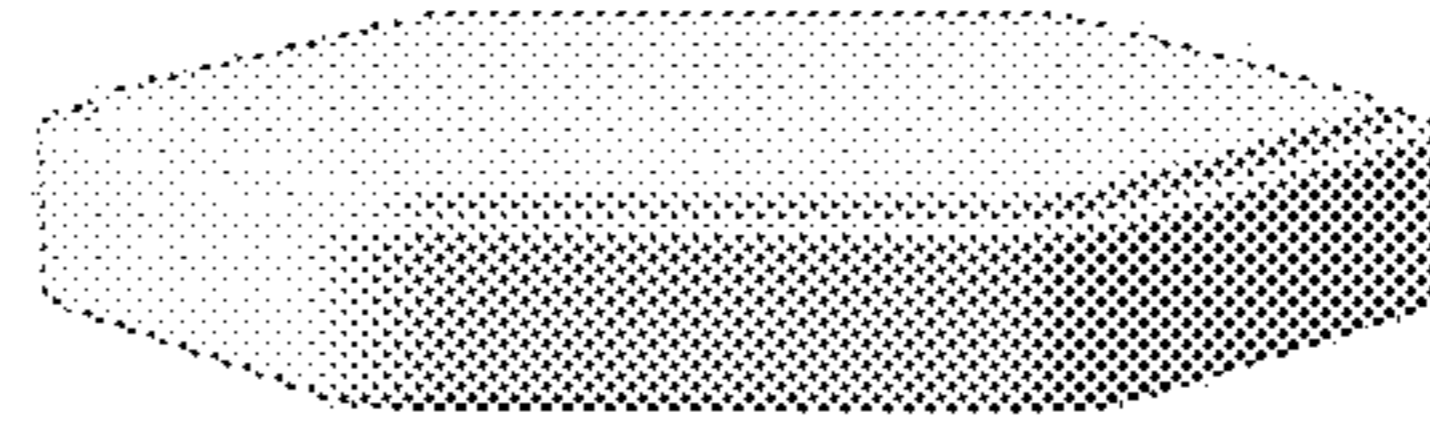



4.1



4.2

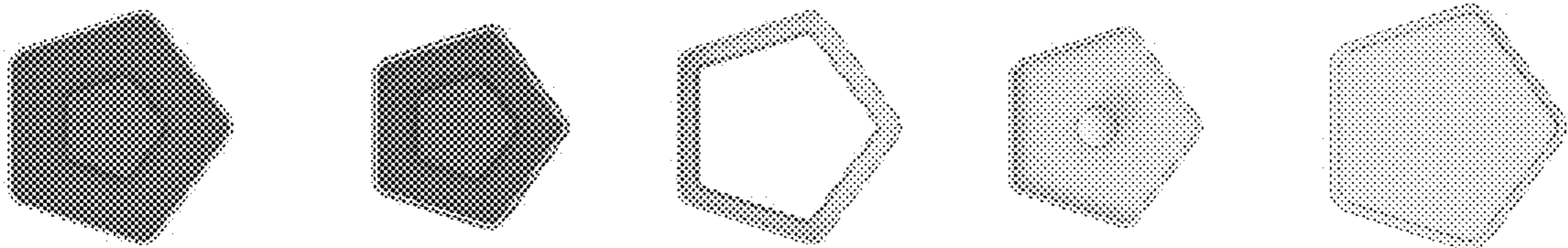

4.3

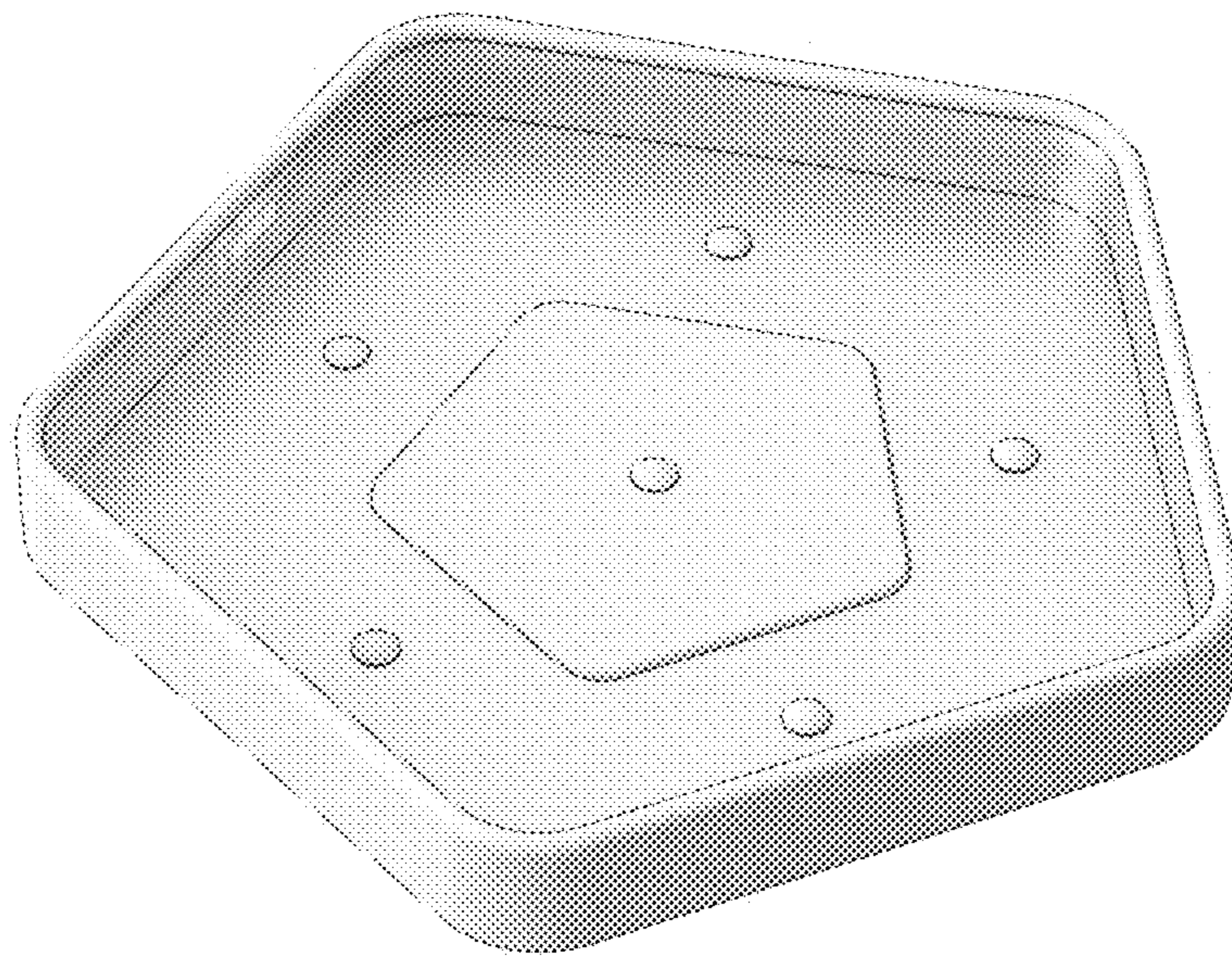

4.4



4.5

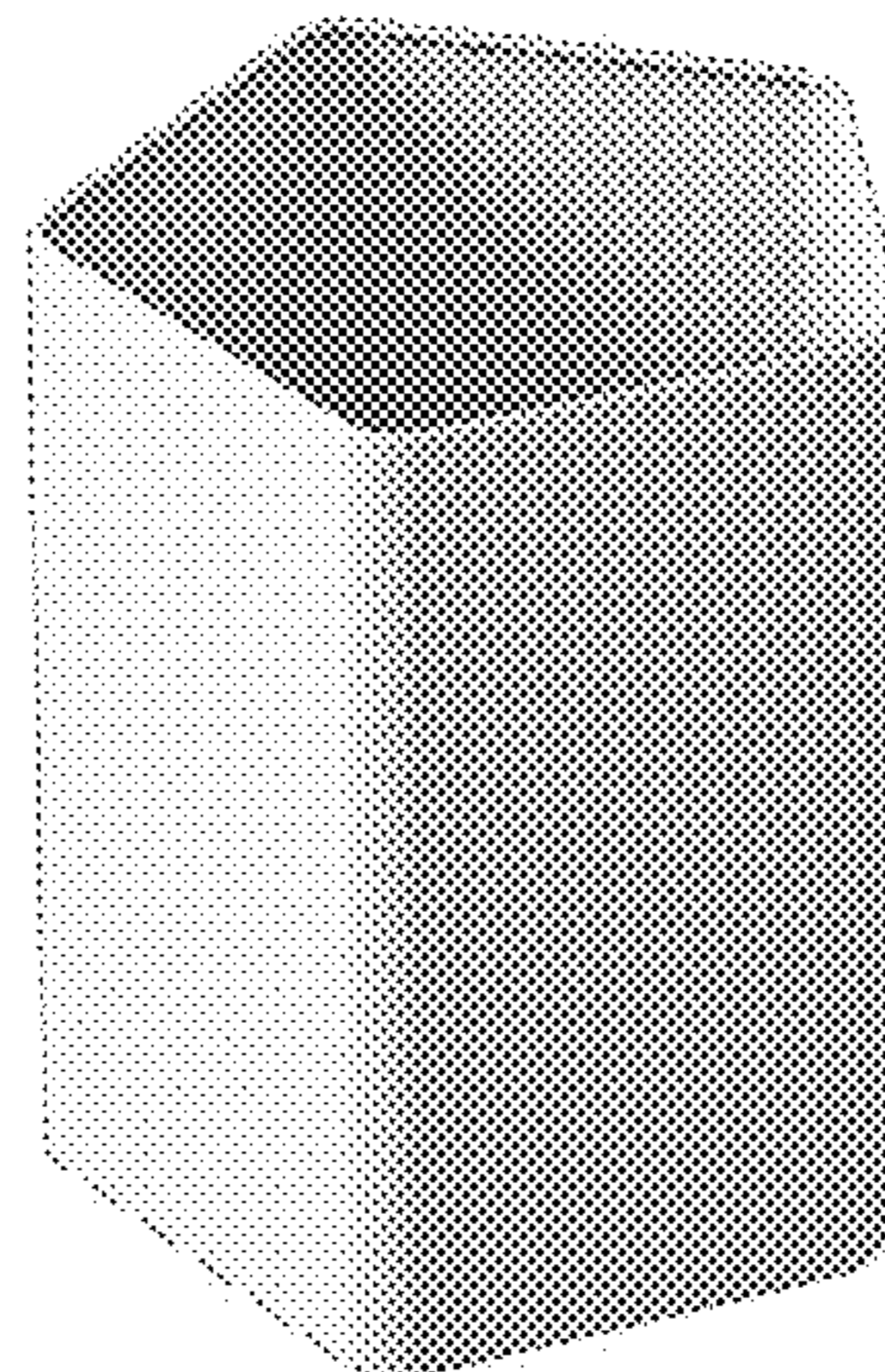
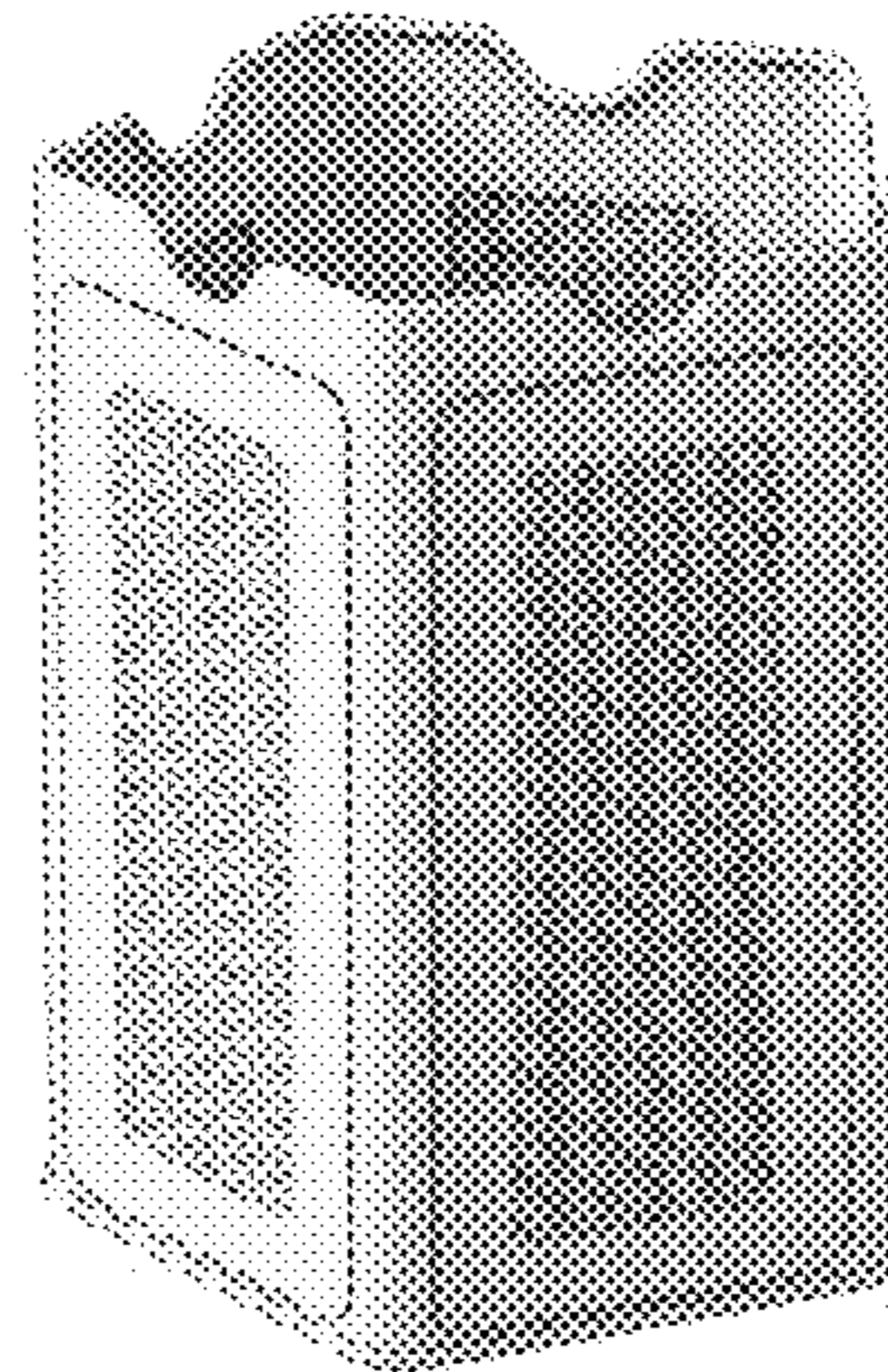
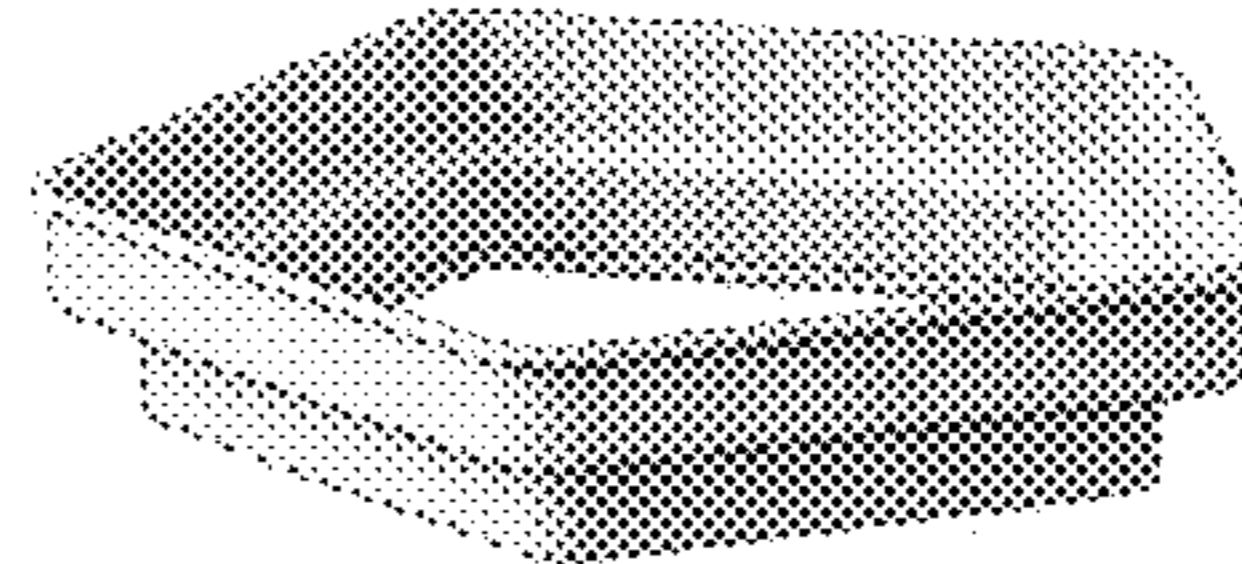
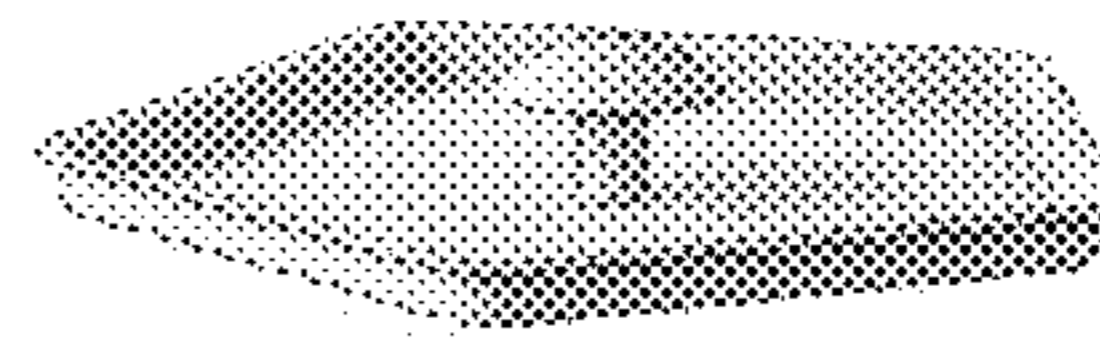
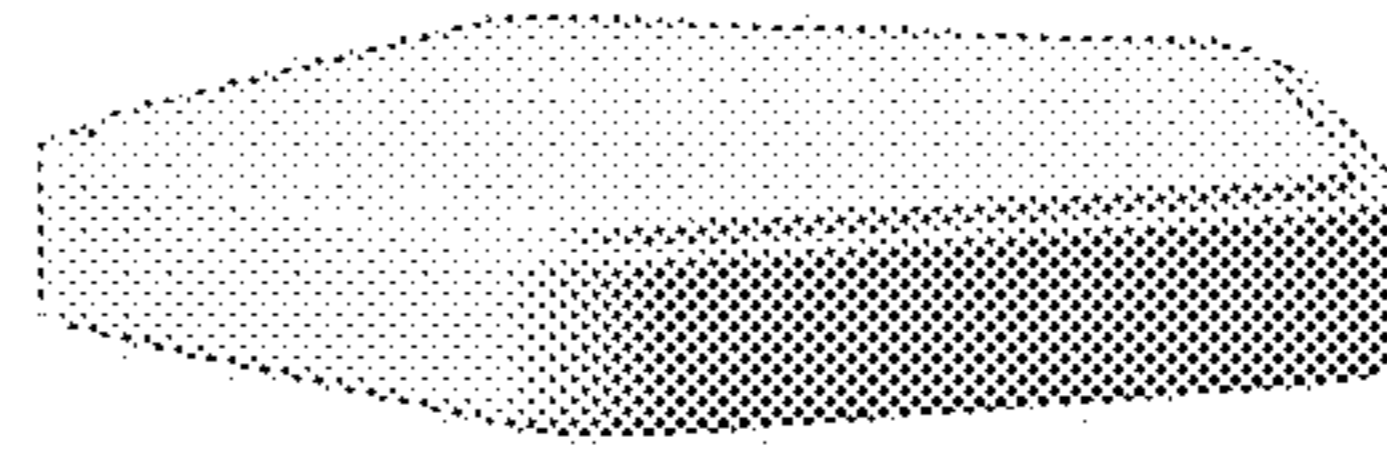

4.6

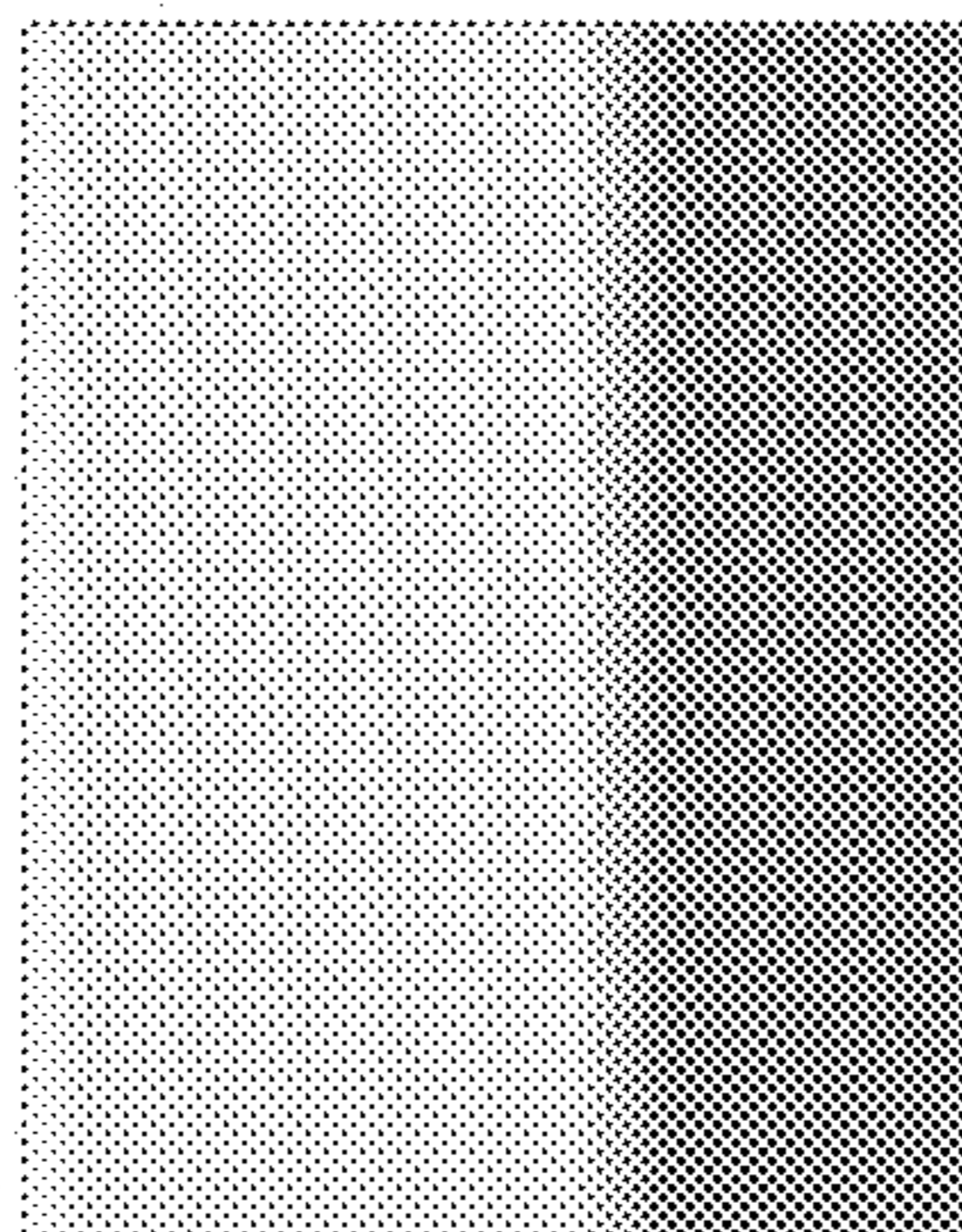
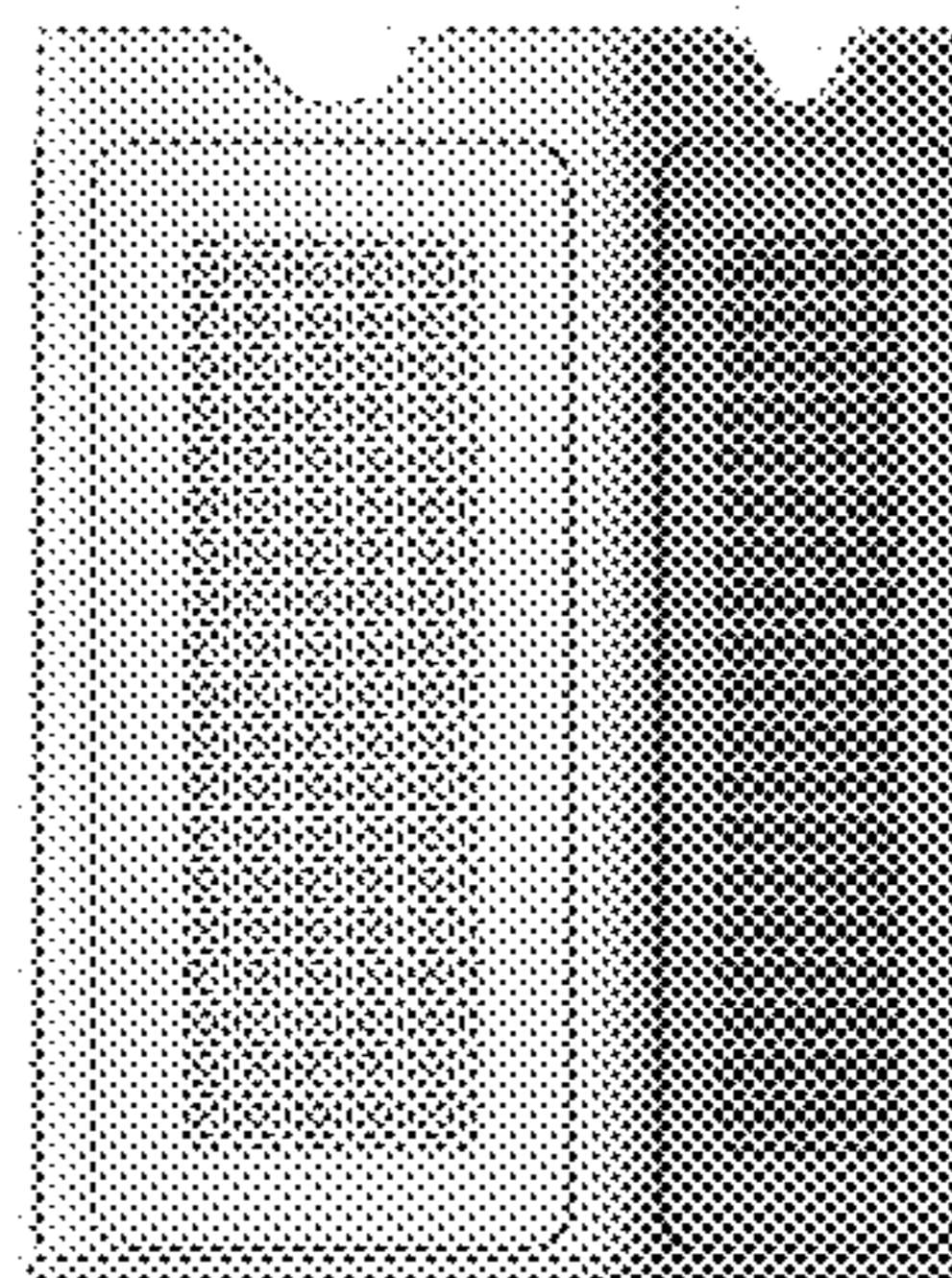
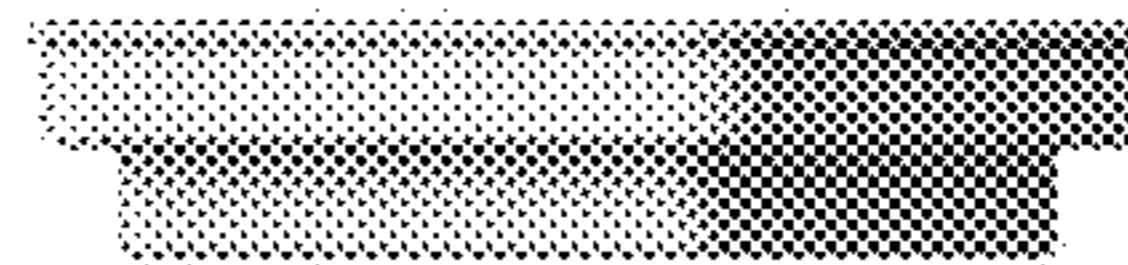
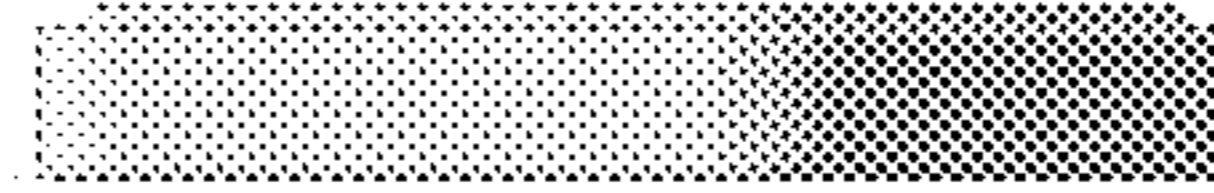

4.7

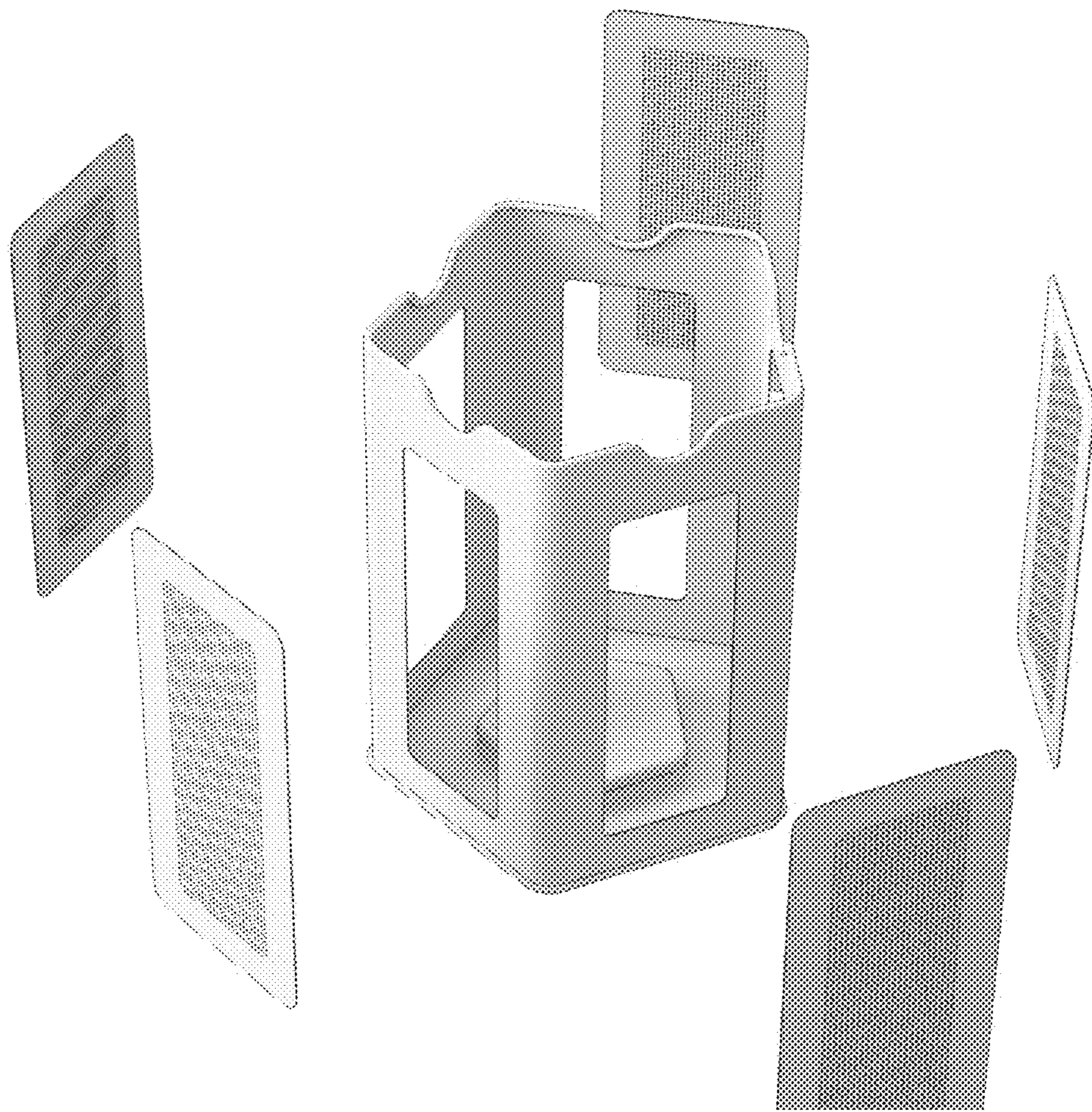

5.1

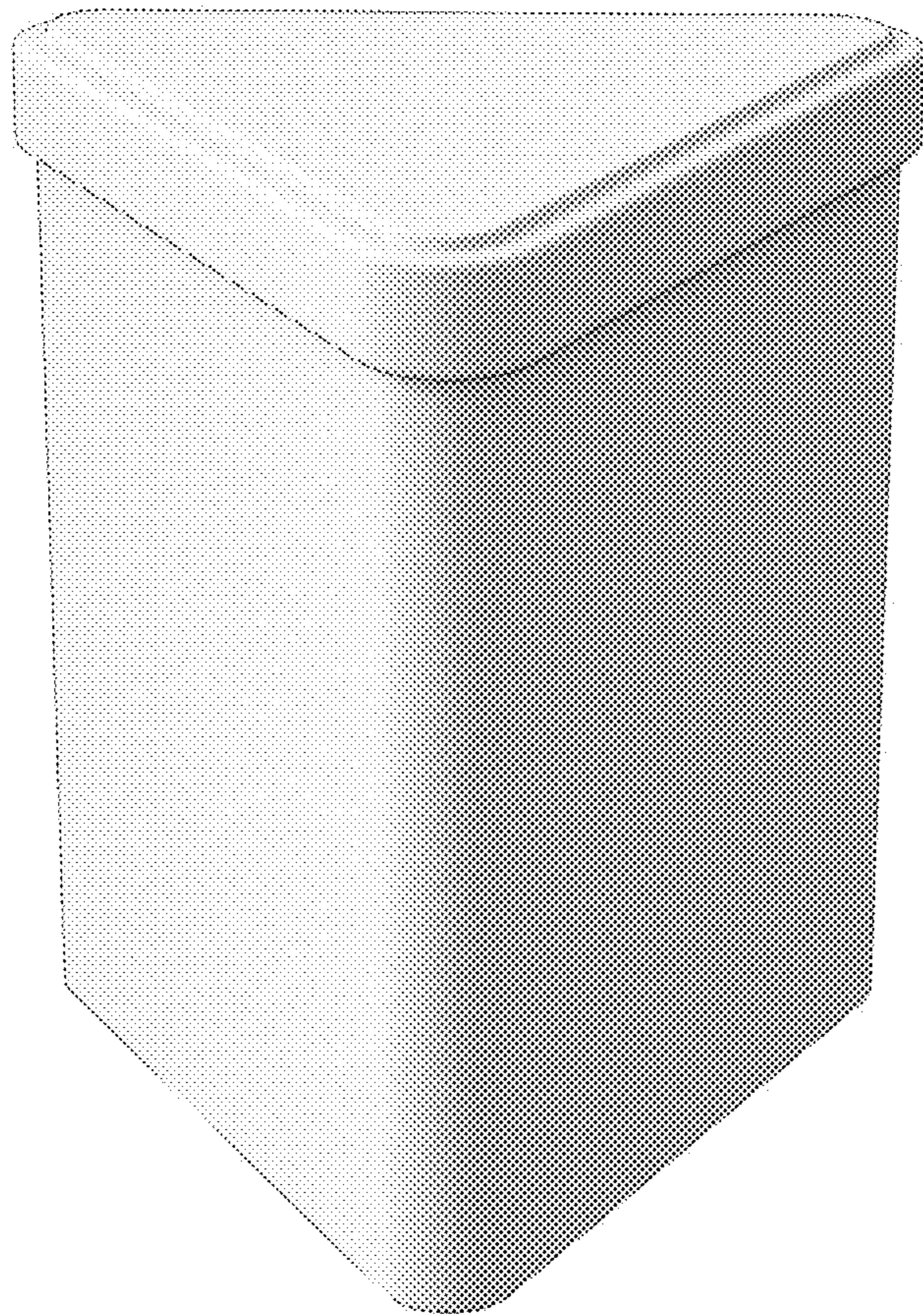



5.2

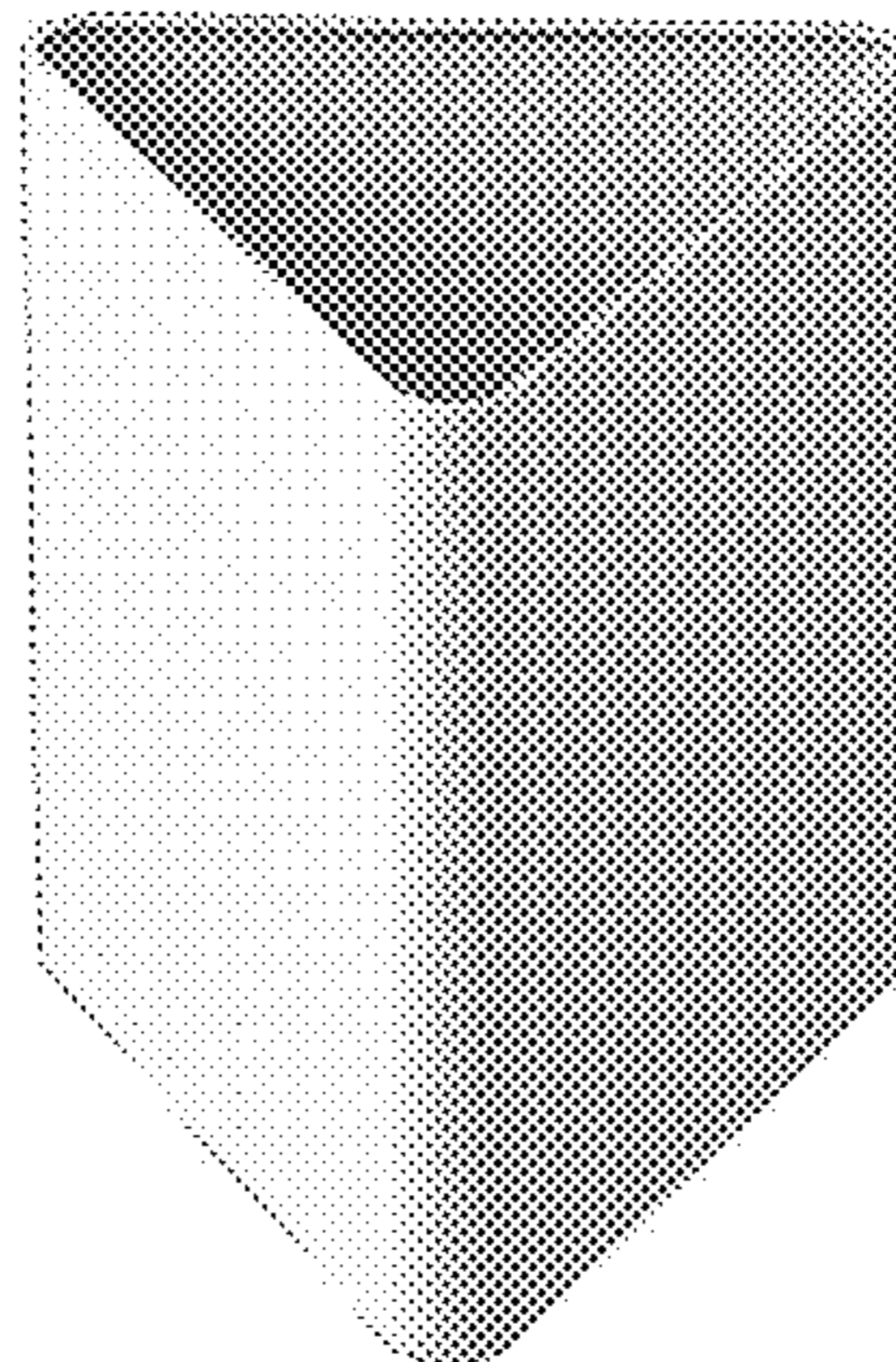
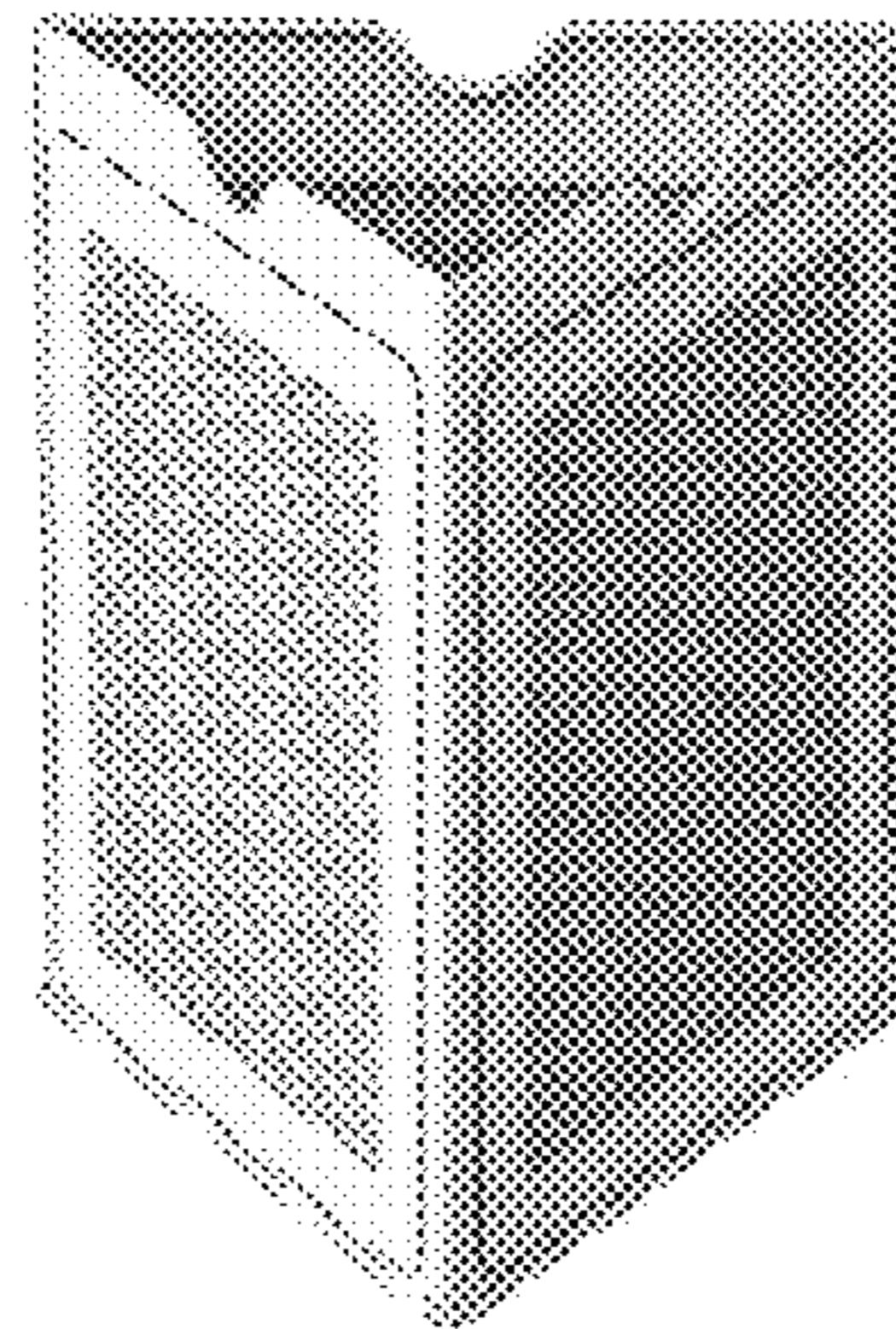
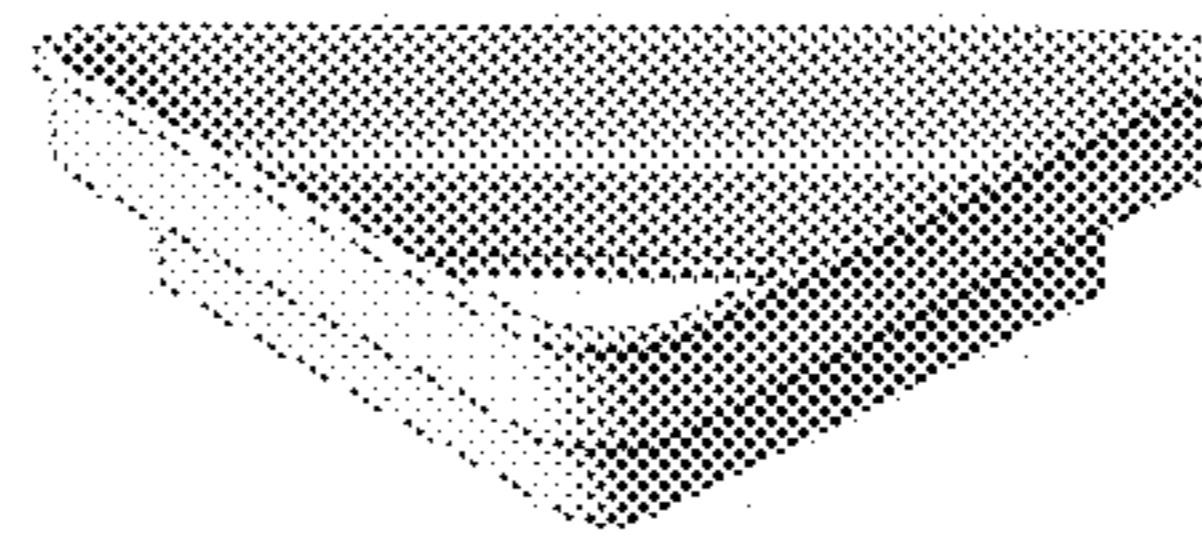
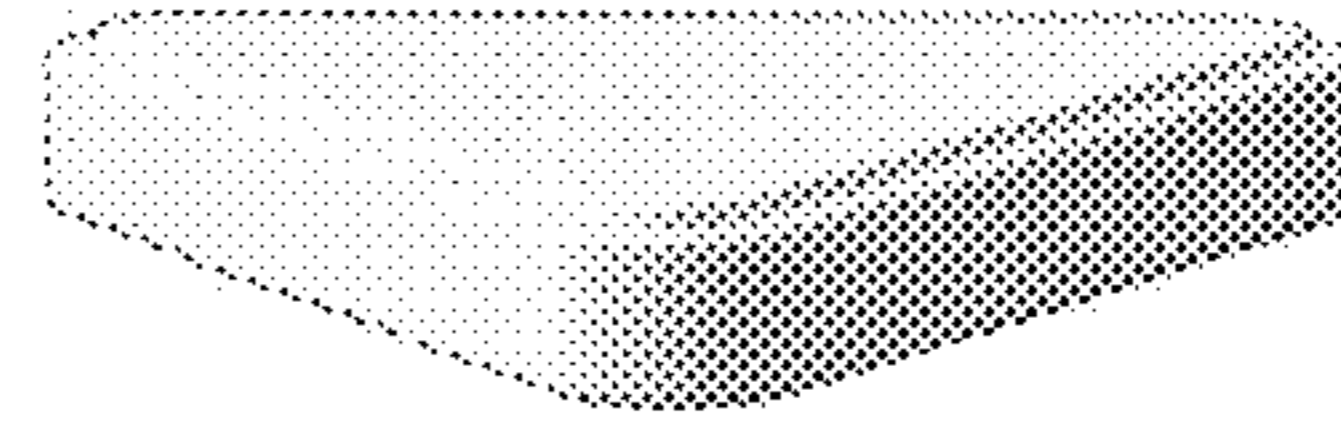

5.3

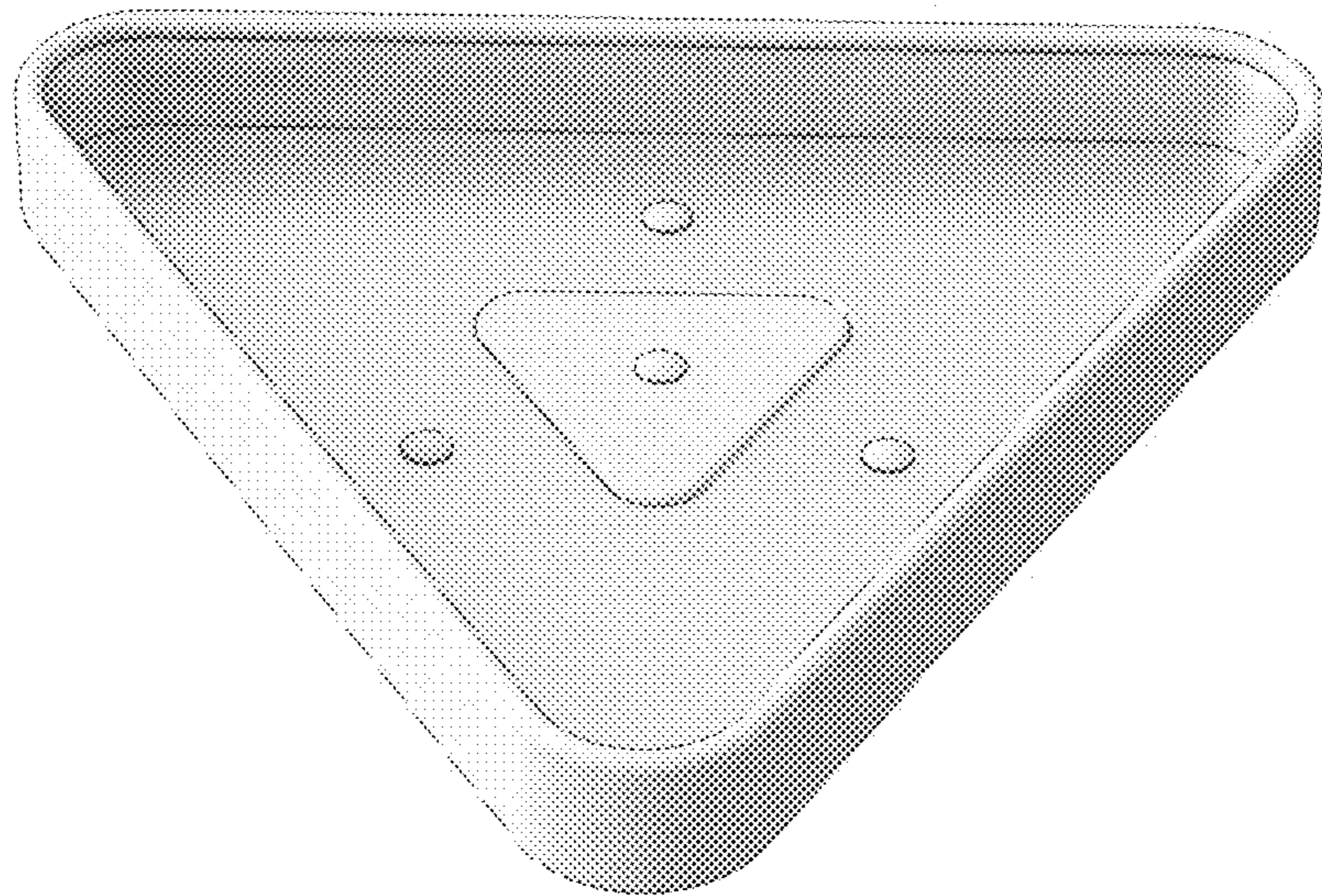

5.4

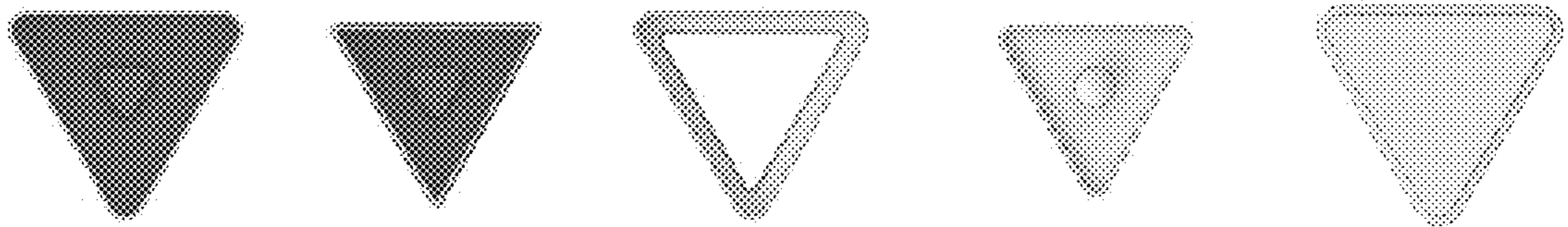

5.5



5.6

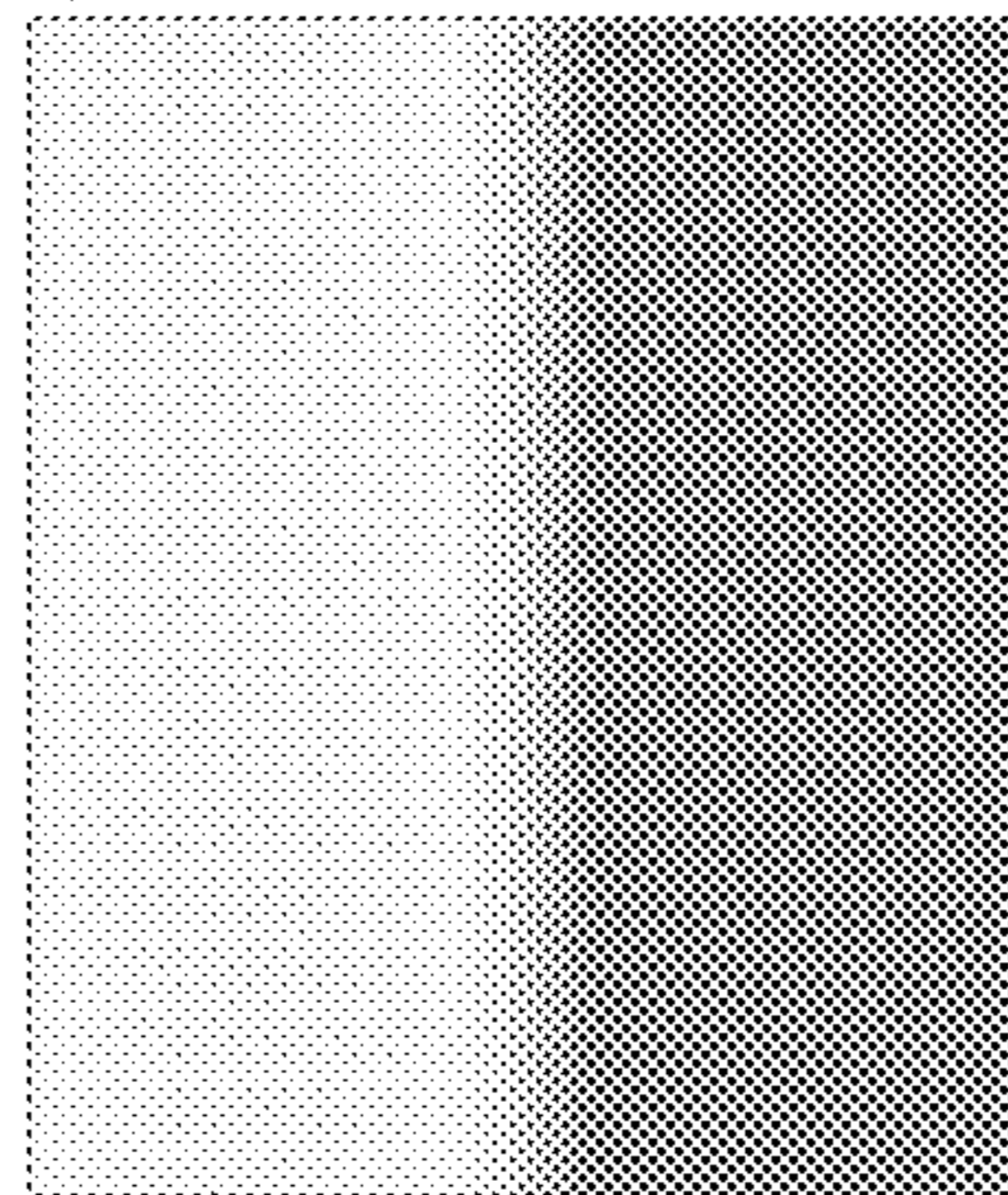
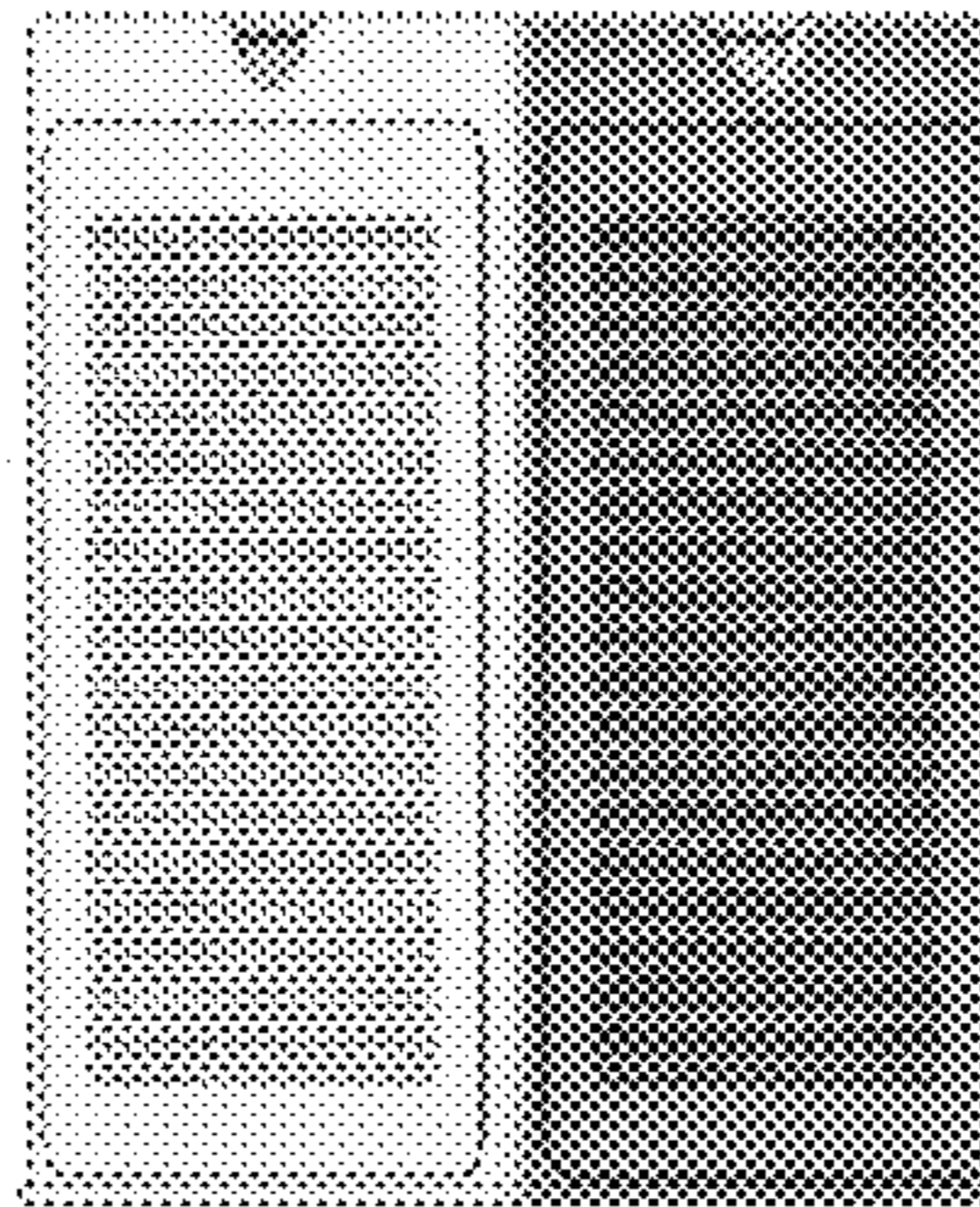
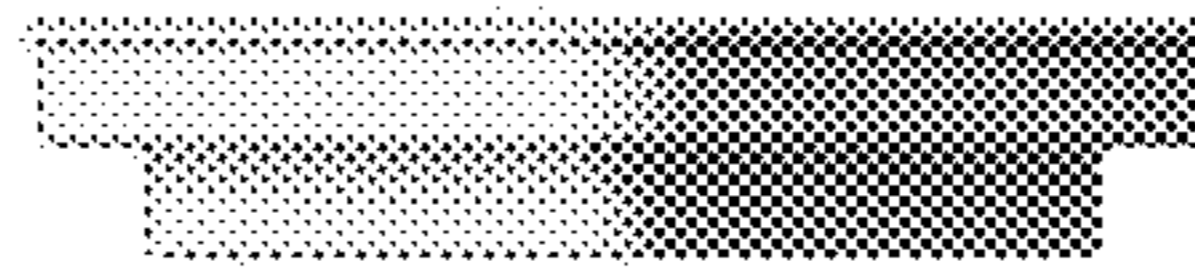
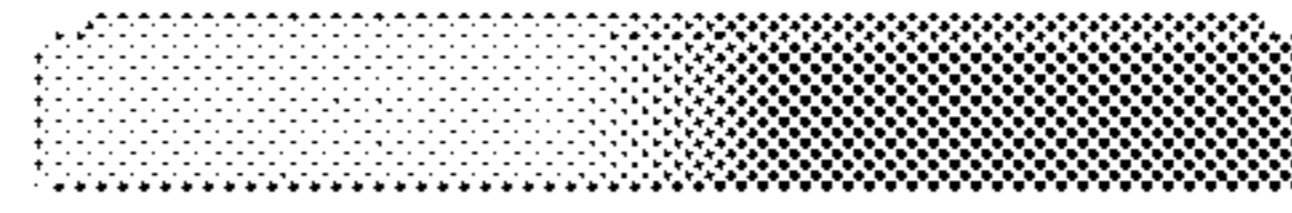

5.7

