



US00D934614S

(12) **United States Design Patent** (10) **Patent No.:** **US D934,614 S**
Ritchie et al. (45) **Date of Patent:** **** Nov. 2, 2021**

(54) **COOKING AND HEATING APPARATUS**
(71) Applicant: **The Cashmere Caveman Co, Wild Kitchens Limited**, London (GB)
(72) Inventors: **Guy Stuart Ritchie**, London (GB); **Nigel Bruce True**, London (GB)
(73) Assignee: **The Cashmere Caveman Co, Wild Kitchens Limited**, London (GB)
(**) Term: **15 Years**

(21) Appl. No.: **29/736,710**
(22) Filed: **Jun. 2, 2020**

(30) **Foreign Application Priority Data**
Dec. 11, 2019 (GB) 6078752
Dec. 11, 2019 (GB) 6078753
Dec. 11, 2019 (GB) 6078754
Dec. 11, 2019 (GB) 6078755
Dec. 11, 2019 (GB) 6078756
Dec. 11, 2019 (GB) 6078757

(51) **LOC (13) Cl.** **07-02**
(52) **U.S. Cl.**
USPC **D7/348**

(58) **Field of Classification Search**
USPC D7/323, 328-330, 334, 339-349, 390, D7/402-406; D8/300-306
CPC .. A21B 2/00; A23B 4/052; A47J 37/00; A47J 37/06; A47J 37/0611; A47J 37/0731; A47J 37/08; A47J 37/0807; A47J 37/0814; A47J 37/0835; A47J 37/0842; A47J 37/085; A47J 37/0864; A47J 37/0878; A47J 37/0885; A47J 37/0892; F24B 1/202; F24C 7/00; F24C 7/002; F24C 7/046; F24C 7/067; F24C 15/02; F24C 15/04; F24C 15/10; F24C 15/102

See application file for complete search history.

(56) **References Cited**
U.S. PATENT DOCUMENTS
2,922,414 A * 1/1960 Brender F24B 1/202 126/9 R
6,039,039 A * 3/2000 Pina, Jr. A23B 4/052 126/25 R
D694,056 S * 11/2013 Dahle D7/334
D812,957 S * 3/2018 McGuinness D7/334
D871,822 S * 1/2020 Hussain D7/334
(Continued)

Primary Examiner — Ricky Pham
(74) *Attorney, Agent, or Firm* — Brown Rudnick LLP

(57) **CLAIM**
The ornamental design for a cooking and heating apparatus, as shown and described.

DESCRIPTION

FIG. 1 illustrates a perspective view of a cooking and heating apparatus employing an ornamental design in accordance with the present invention;
FIG. 2 is a left side view of the cooking and heating apparatus of FIG. 1;
FIG. 3 is a right side view of the cooking and heating apparatus of FIG. 1;
FIG. 4 is a back view of the cooking and heating apparatus of FIG. 1;
FIG. 5 is a front view of the cooking and heating apparatus of FIG. 1;
FIG. 6 is a top view of the cooking and heating apparatus of FIG. 1; and,
FIG. 7 is a bottom view of the cooking and heating apparatus of FIG. 1.
The broken lines shown in the drawings represent unclaimed portions of the structure and form no part of the claimed design. Furthermore, the interior surfaces that are shown without surface shading form no part of the claimed design.

1 Claim, 7 Drawing Sheets

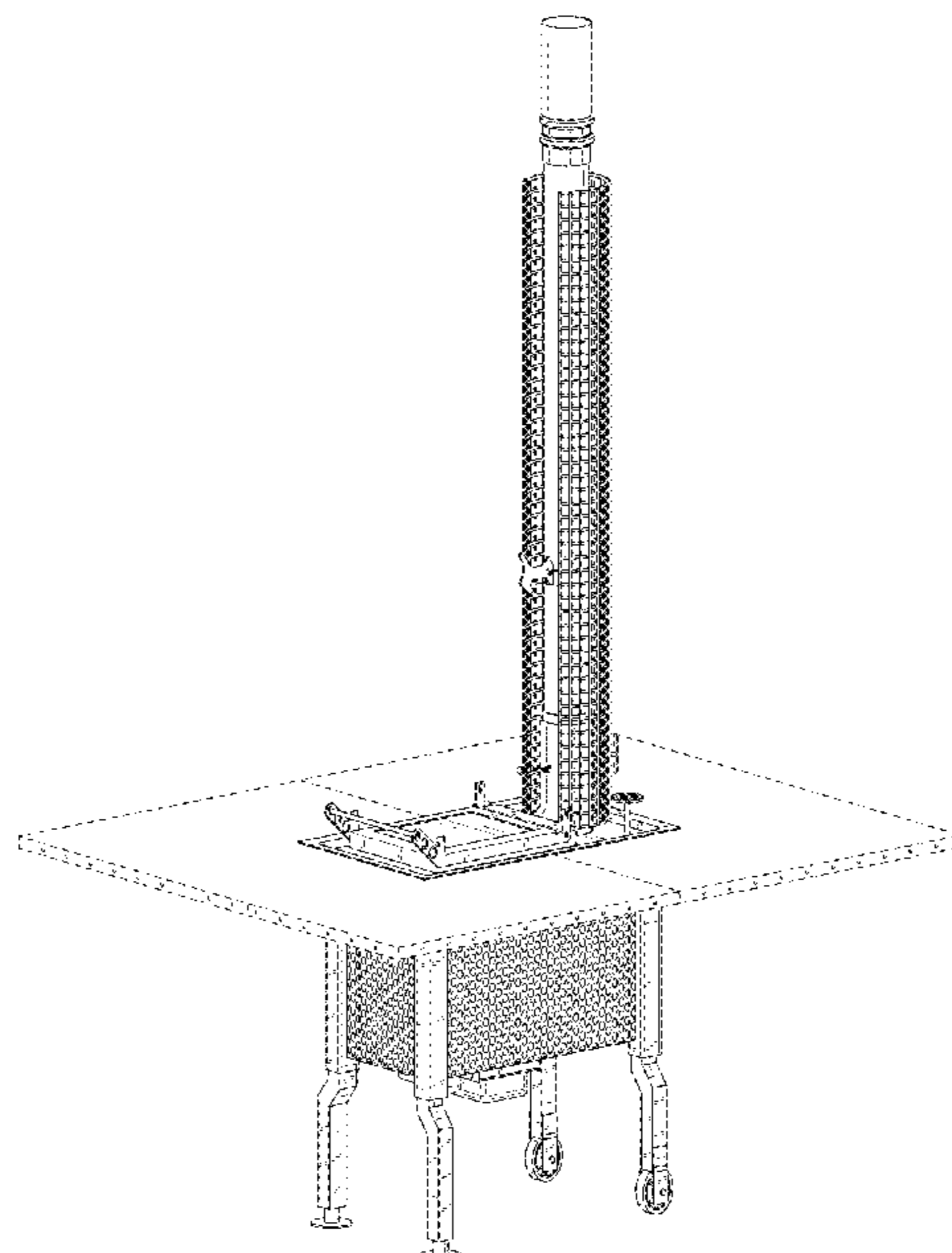

(56)

References Cited

U.S. PATENT DOCUMENTS

2021/0113015 A1* 4/2021 Carayannopoulos
A47J 37/0731

* cited by examiner

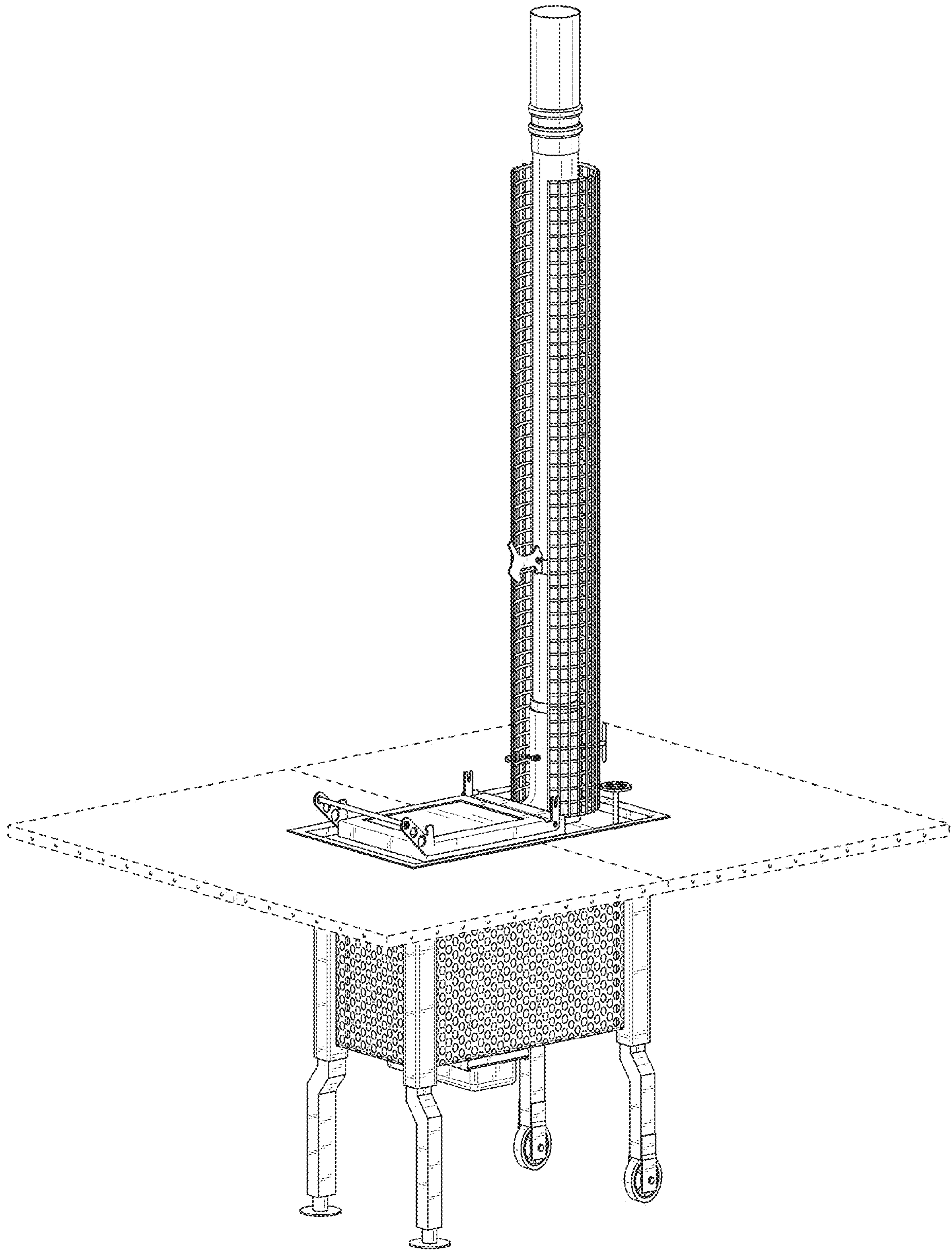

FIG. 1

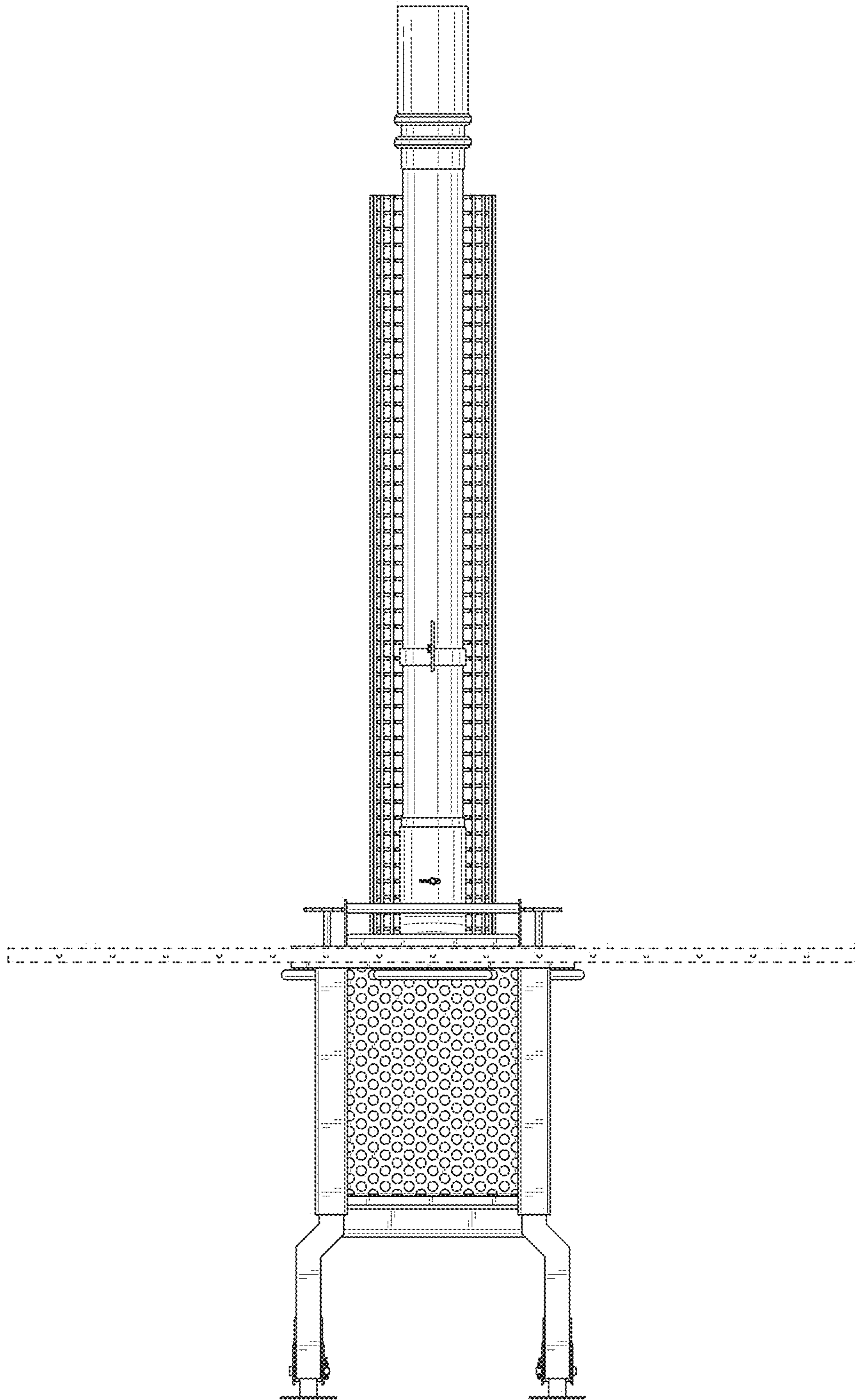

FIG. 2

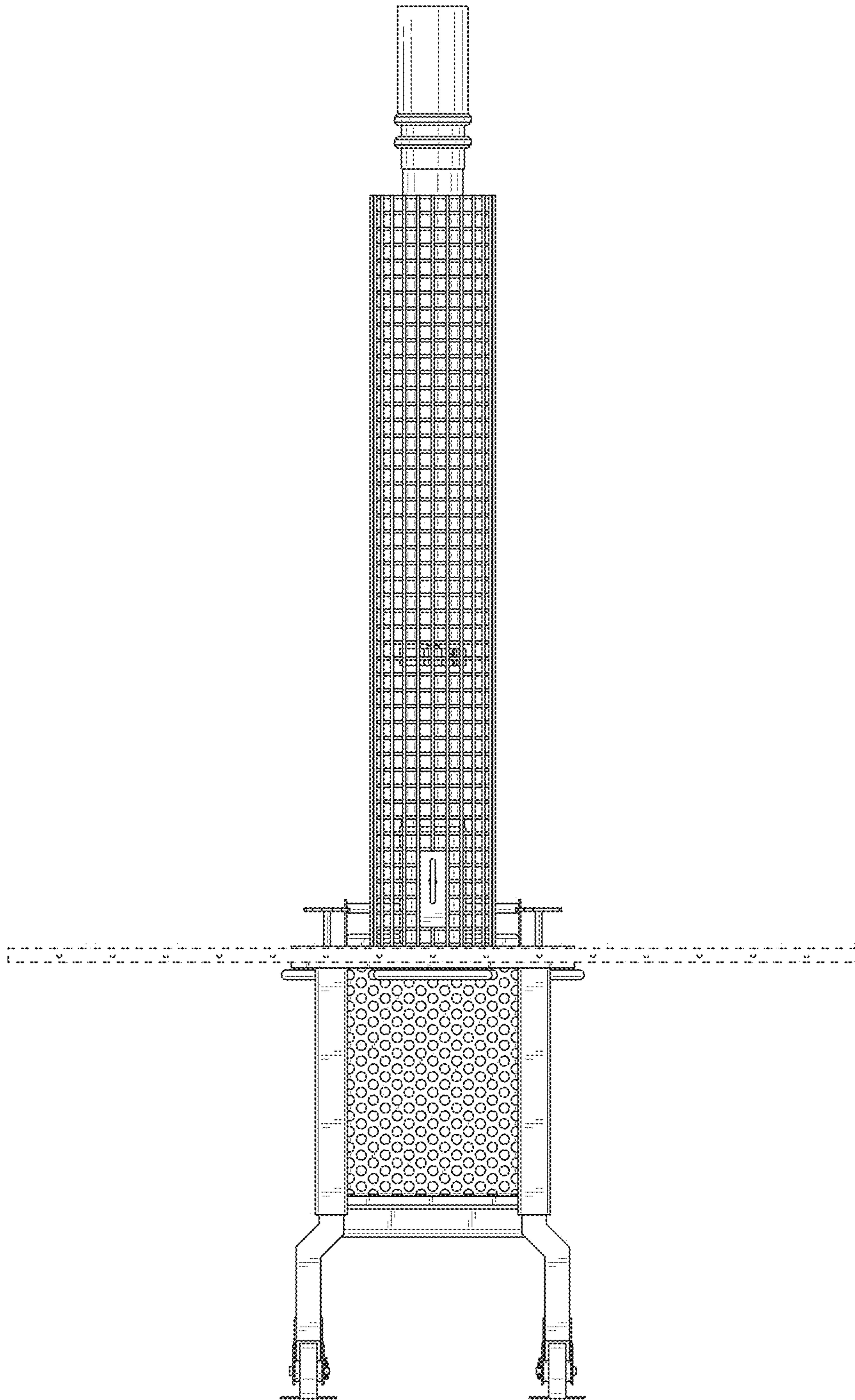

FIG. 3

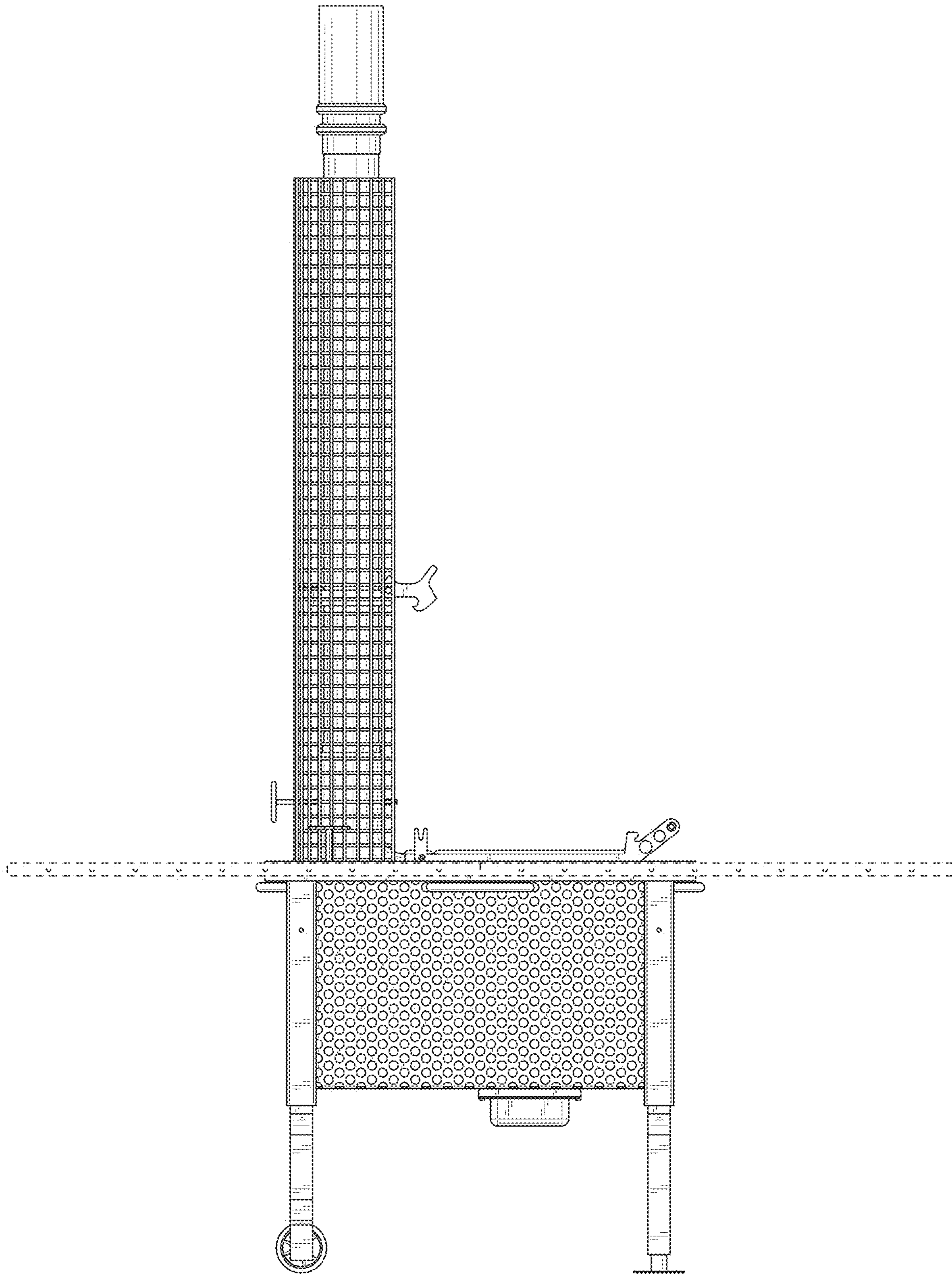

FIG. 4

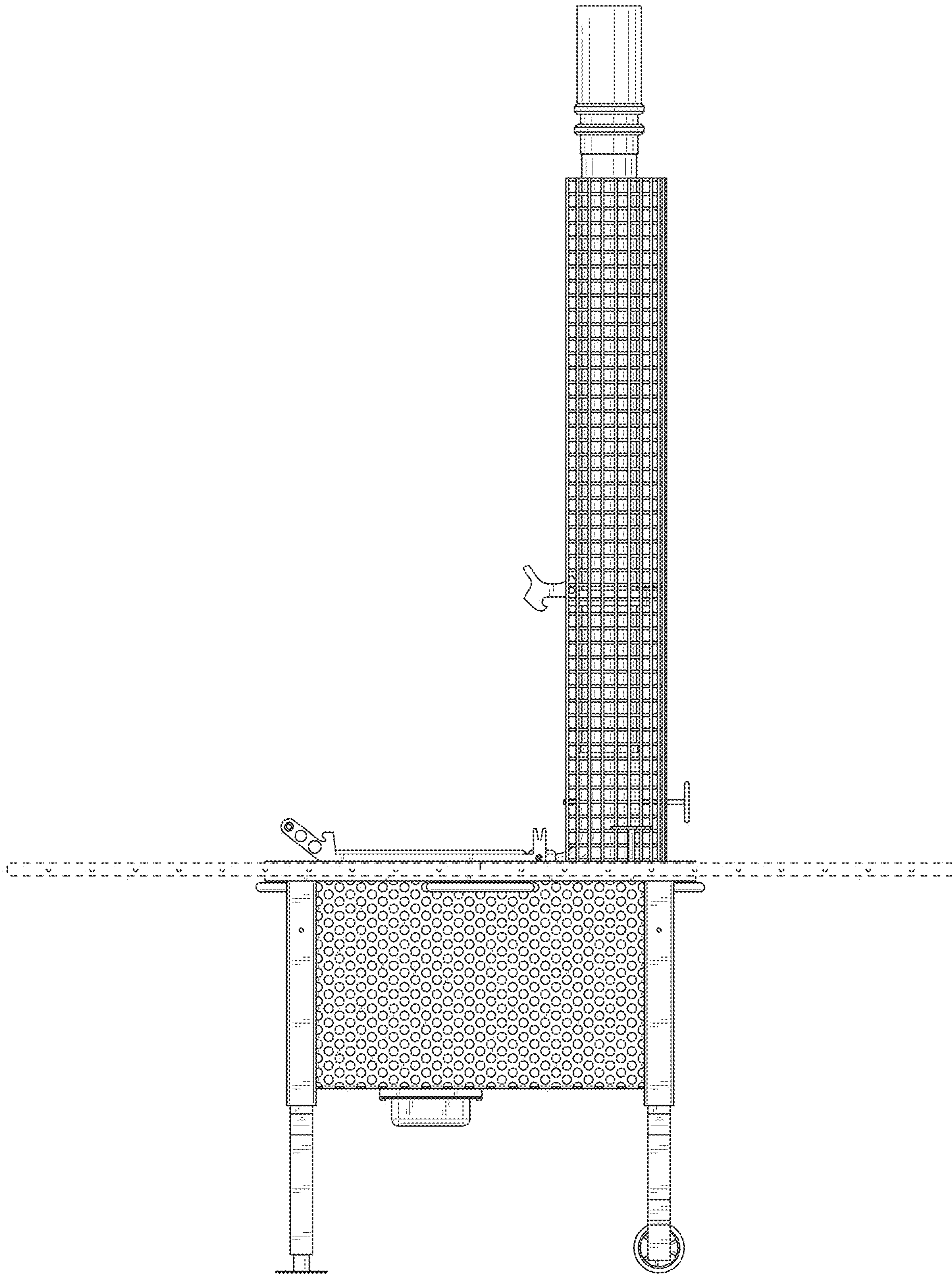

FIG. 5

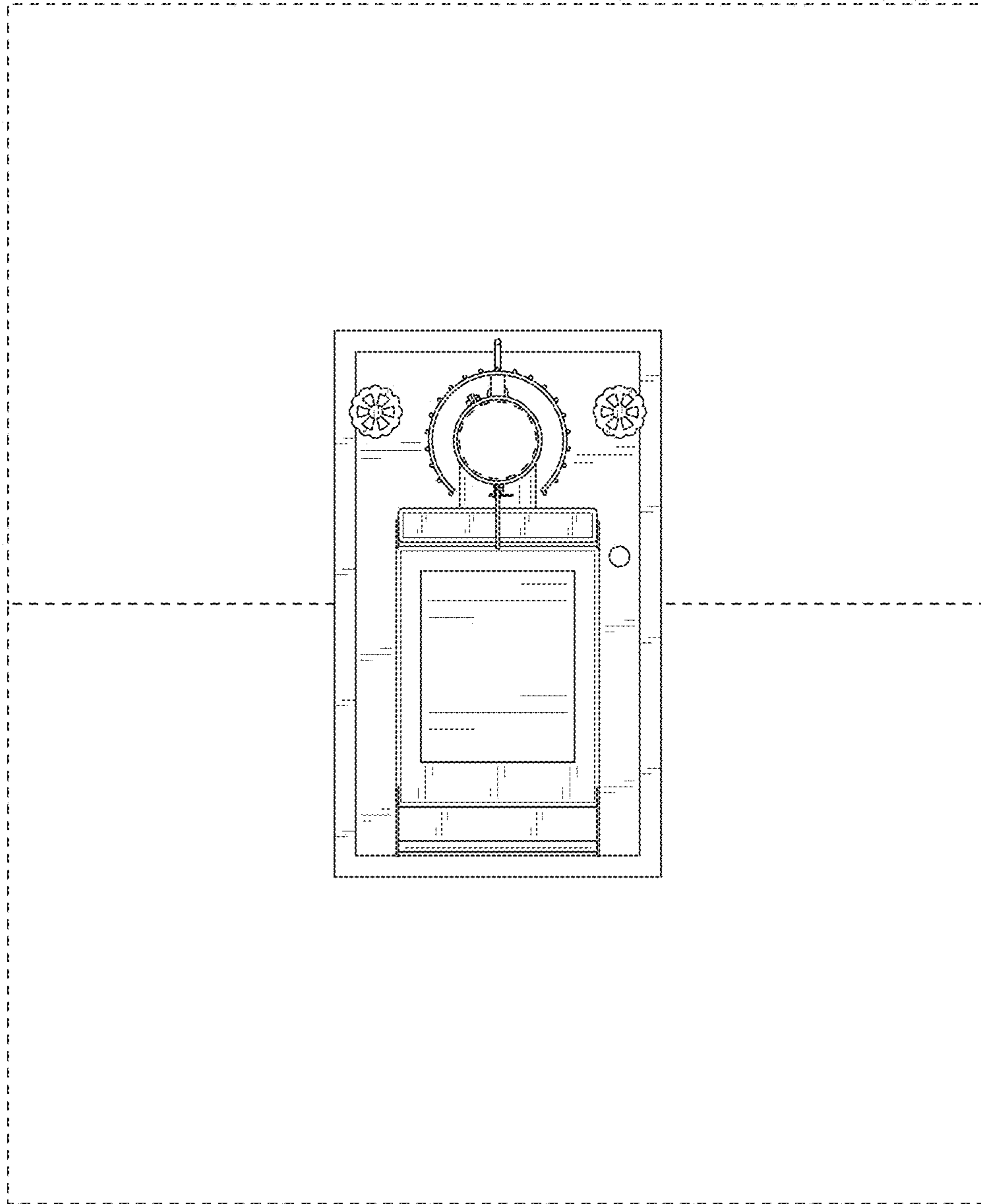

FIG. 6

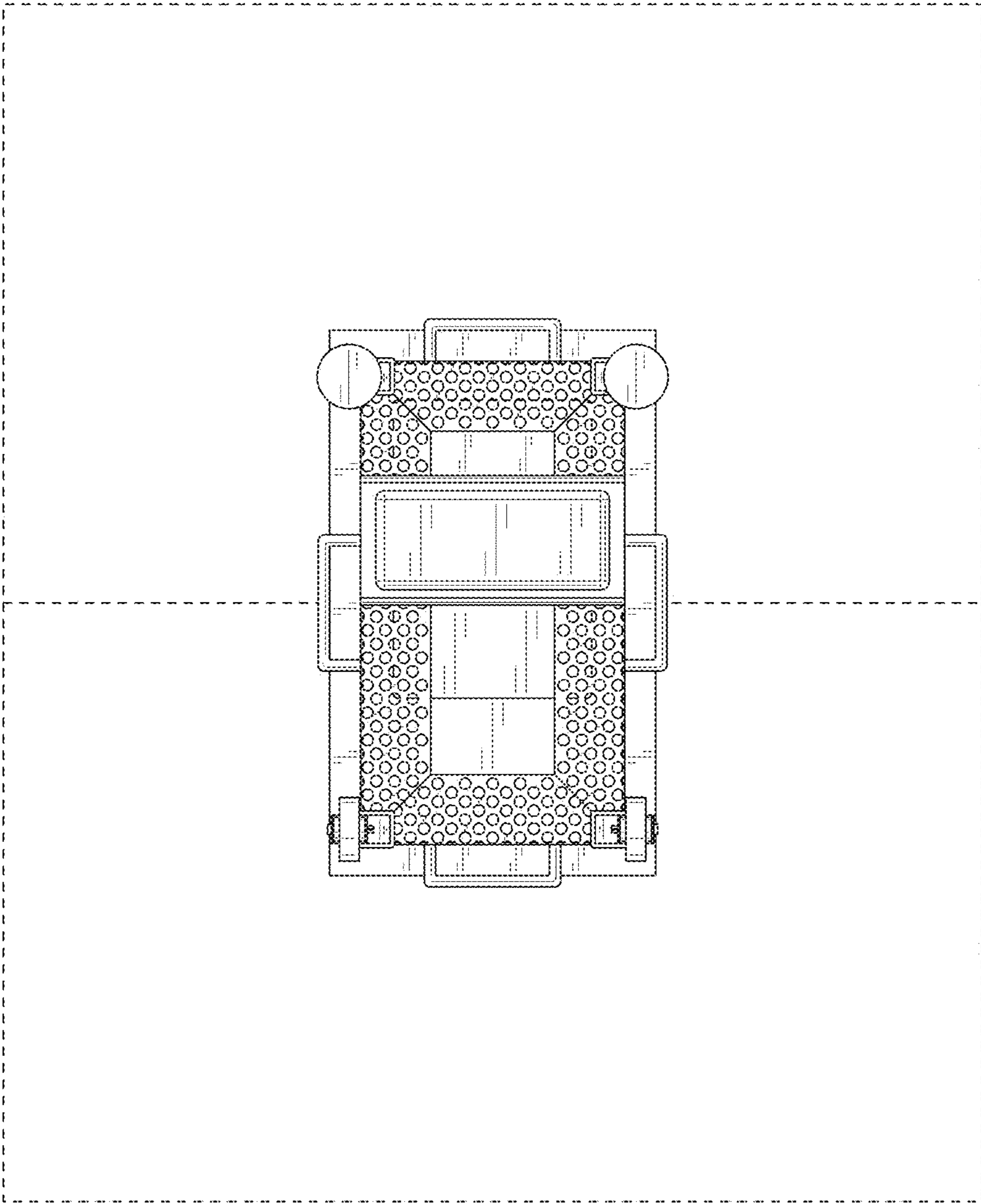

FIG. 7