



US00D934576S

(12) **United States Design Patent** (10) **Patent No.:** **US D934,576 S**  
**Liu** (45) **Date of Patent:** **\*\* Nov. 2, 2021**

(54) **MIRROR**

FOREIGN PATENT DOCUMENTS

(71) Applicant: **Shenzhen JianYuanDa Mirror Technology Co., Ltd., Shenzhen (CN)**

EM 008142772-0001 \* 8/2020  
GB 9008142772-0001 \* 8/2020

(72) Inventor: **Changwei Liu, Shenzhen (CN)**

OTHER PUBLICATIONS

(\*\*) Term: **15 Years**

(21) Appl. No.: **29/746,639**

Fascinate Rechargeable Lighted Makeup Mirror [online], [site visited Sep. 8, 2021]. Available from internet, URL: <https://www.amazon.ca/FASCINATE-Rechargeable-Dimmable-Portable-Illuminated/dp/B088F832WH/ref=sr\_1\_1?dchild=1&keywords=B088F832WH&qid=1631136519&sr=8-1> (Year: 2020).\*

(22) Filed: **Aug. 14, 2020**

Makeup Mirrors rectangle [online], [site visited Sep. 8, 2021]. Available from internet, URL: <https://jianyuanda.en.alibaba.com/product/1600112956693-827866156/Makeup\_Mirrors\_rectangle\_3\_color\_compact\_lighted\_travel\_makeup\_mirror\_for\_cosmetic.html?spm=a2700.shop\_index.3973.1.495371adaKICxX> (Year: 2021).\*

(51) **LOC (13) Cl.** ..... **06-07**

(52) **U.S. Cl.**  
USPC ..... **D6/300**

(58) **Field of Classification Search**

USPC ..... D6/300, 301, 302, 303, 304, 307, 308, D6/309, 310, 311, 312, 313, 314; D28/64.1-64.7; D14/336, 341, 371, 372, D14/374, 381, 382, 448, 450  
CPC ..... A45D 42/00; A45D 42/10; A45D 42/16; A45D 42/20; A45D 42/24; A47G 1/00; A47G 1/02; A47G 1/04; A47G 1/0622; B60J 3/0282

\* cited by examiner

See application file for complete search history.

*Primary Examiner* — Cynthia Ramirez

*Assistant Examiner* — Xavier Marti-Santos

(74) *Attorney, Agent, or Firm* — Novoclaims Patent Services LLC; Mei Lin Wong

(57) **CLAIM**

The ornamental design for a mirror, as shown and described.

**DESCRIPTION**

(56) **References Cited**

U.S. PATENT DOCUMENTS

D260,305 S	*	8/1981	MacGregor	.....	D28/83
D282,024 S	*	1/1986	Muranen	.....	D6/300
D309,986 S	*	8/1990	Sakai	.....	D6/308
D313,126 S	*	12/1990	Ratslaff	.....	D6/308
D466,115 S	*	11/2002	Hawkins	.....	D14/341
D483,575 S	*	12/2003	Chan	.....	D6/310
D846,805 S	*	4/2019	Kaiser	.....	D28/64.2
D866,988 S	*	11/2019	Shaffer	.....	D6/300
D882,281 S	*	4/2020	Park	.....	D6/310
D891,790 S	*	8/2020	Liu	.....	D6/301
D905,445 S	*	12/2020	Yang	.....	D6/310
D907,035 S	*	1/2021	Kim	.....	D14/341
D925,239 S	*	7/2021	Cai	.....	D6/312

FIG. 1 is a perspective view of a mirror, showing my new design;

FIG. 2 is rear perspective view thereof;

FIG. 3 is a front view thereof;

FIG. 4 is a rear view thereof;

FIG. 5 is a left side view thereof;

FIG. 6 is a right side view thereof;

FIG. 7 is a top view thereof; and,

FIG. 8 is a bottom view thereof.

The broken lines in the figures are for the purpose of illustrating portions of the mirror, which form no part of the claimed design.

**1 Claim, 8 Drawing Sheets**

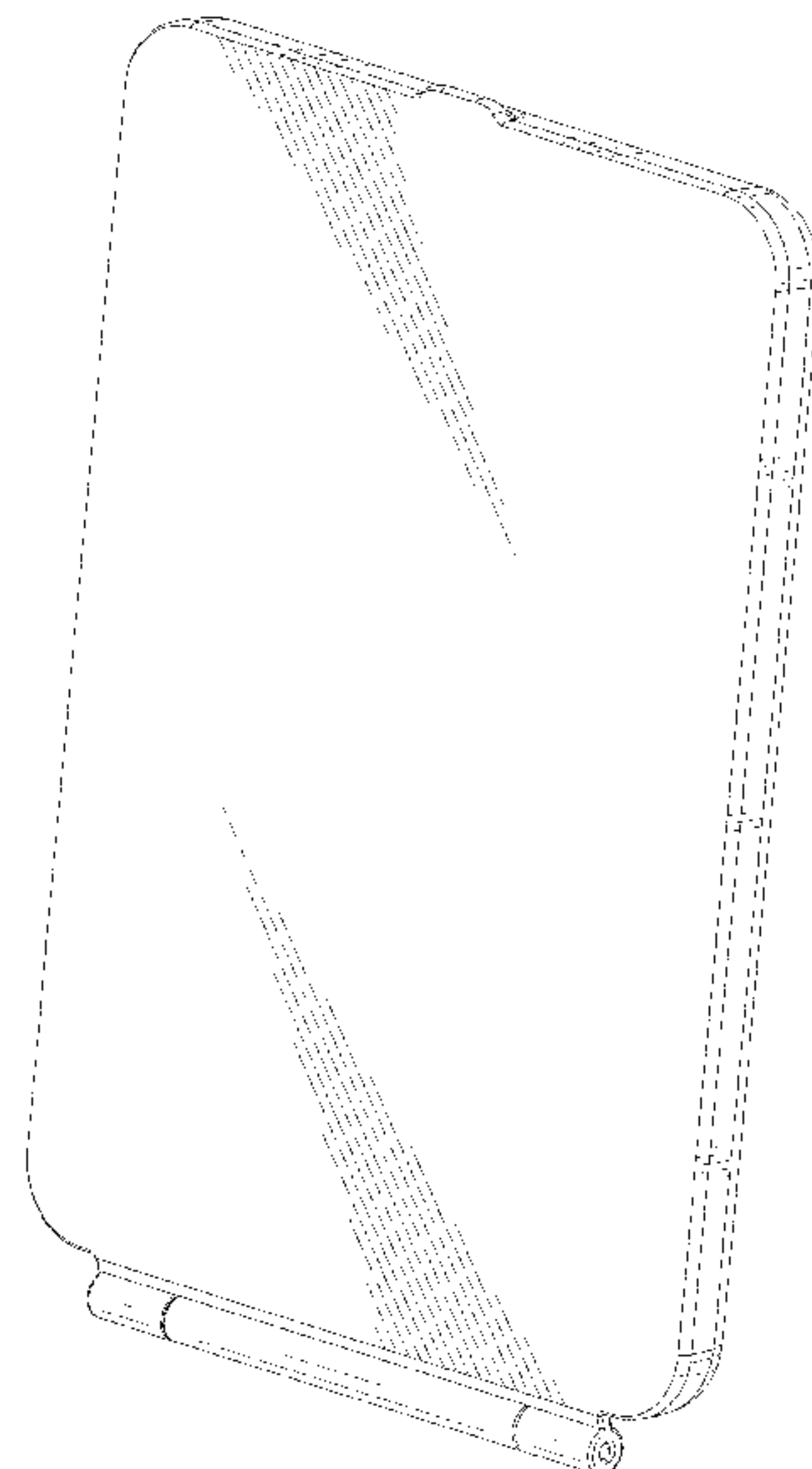

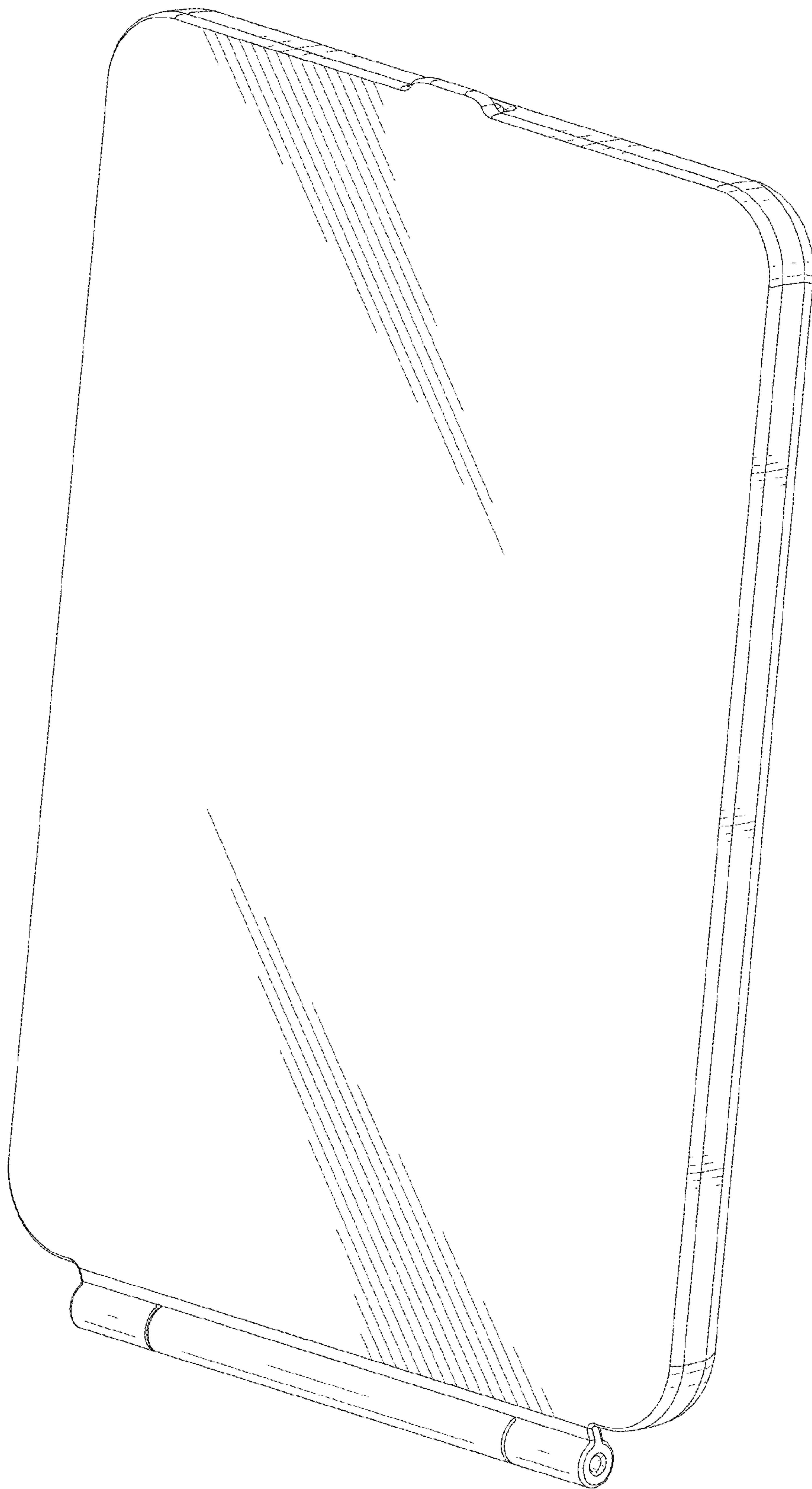

FIG.1

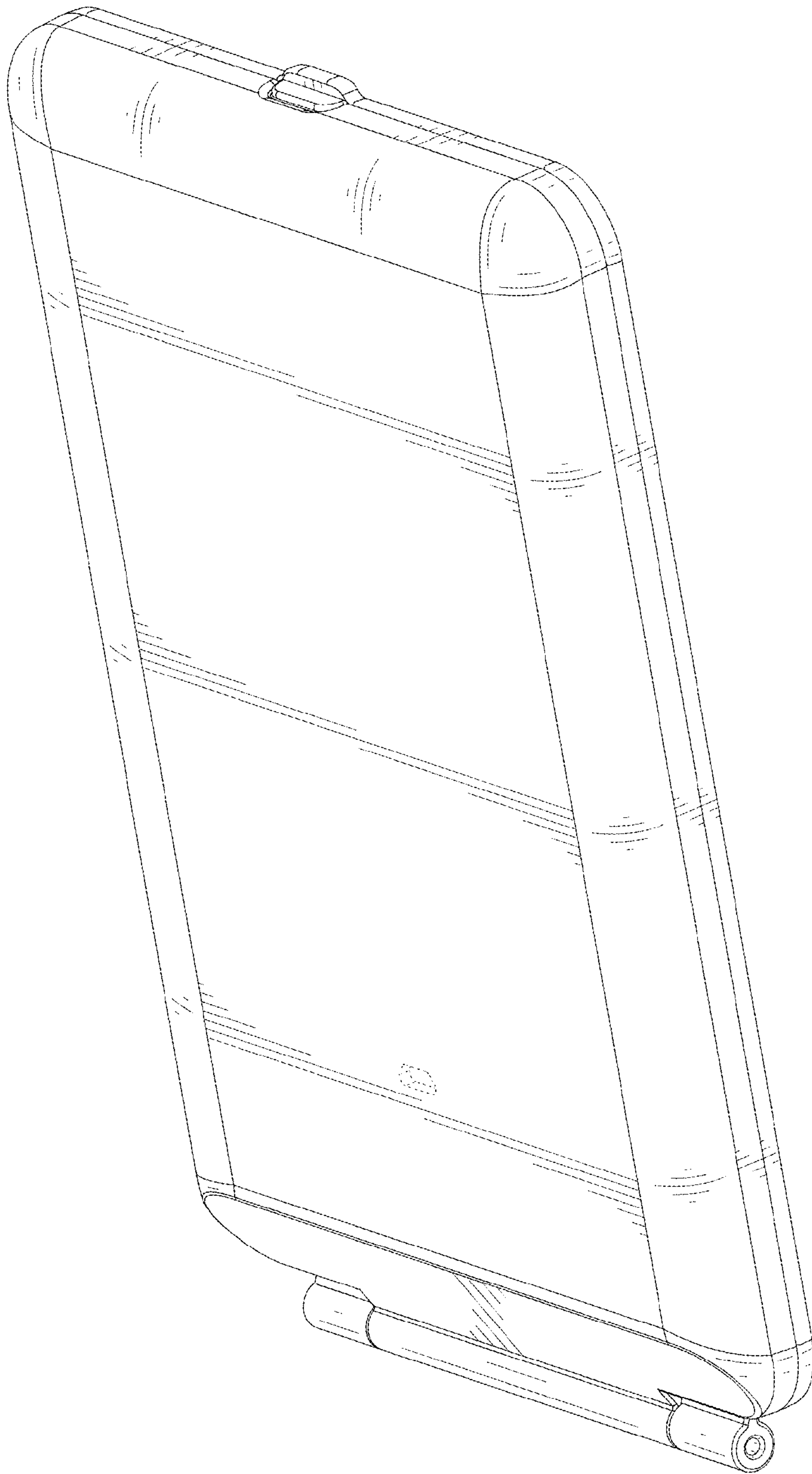

FIG.2

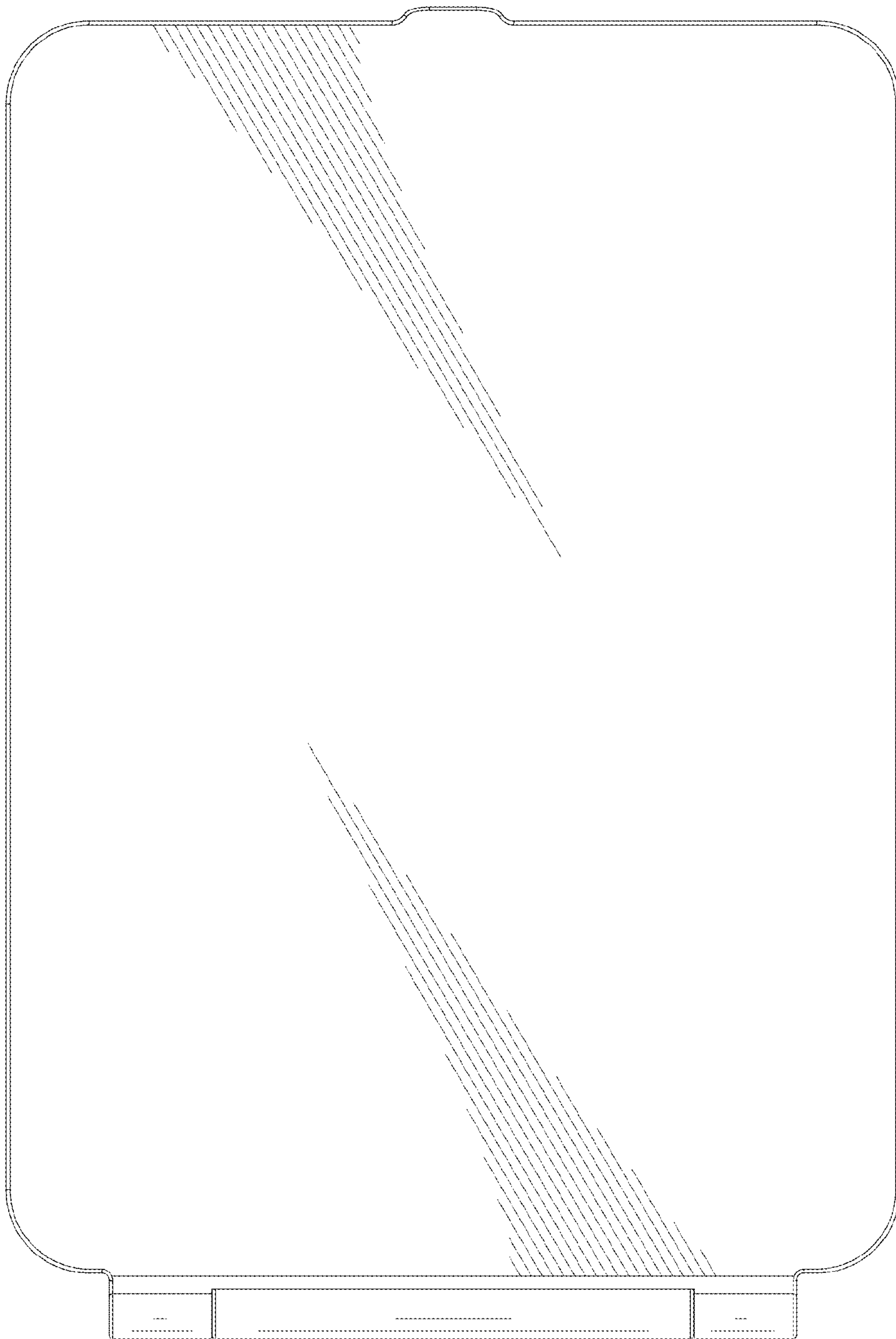

FIG.3

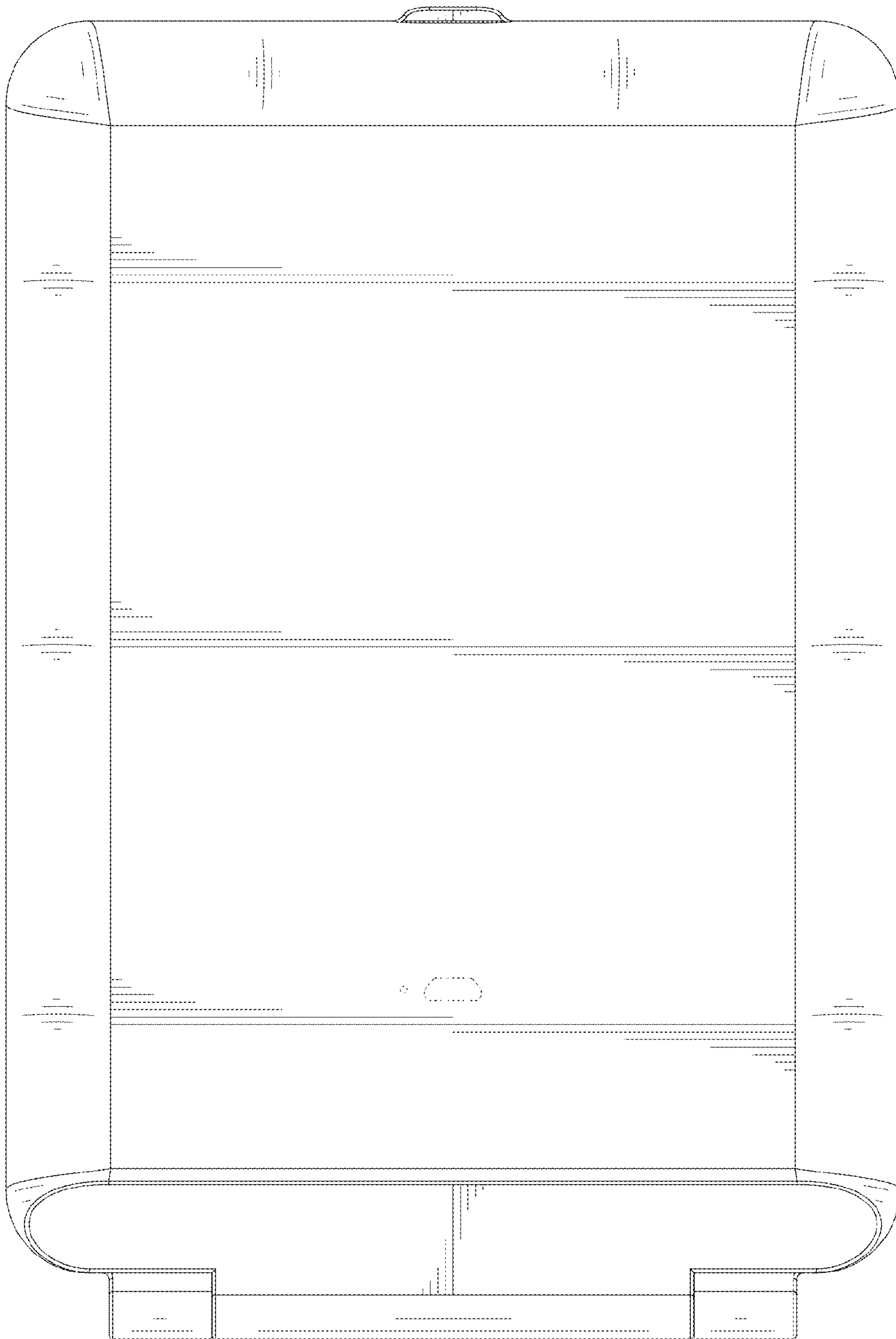

FIG.4



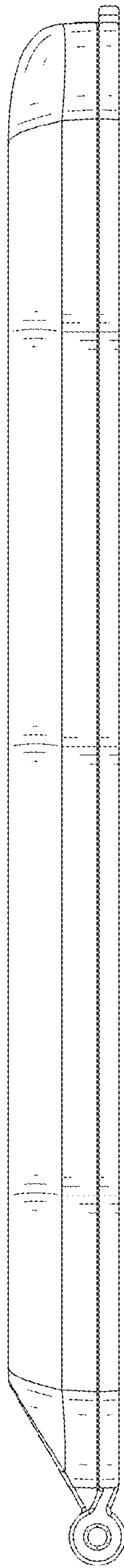

FIG.5

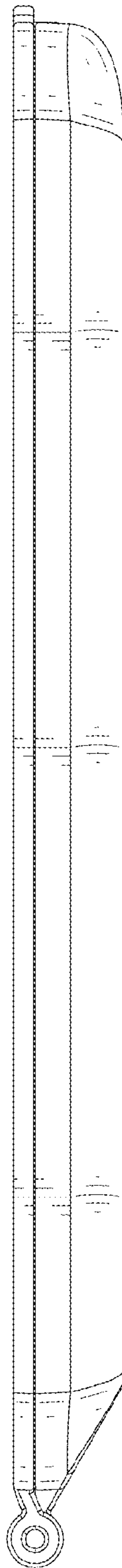

FIG.6

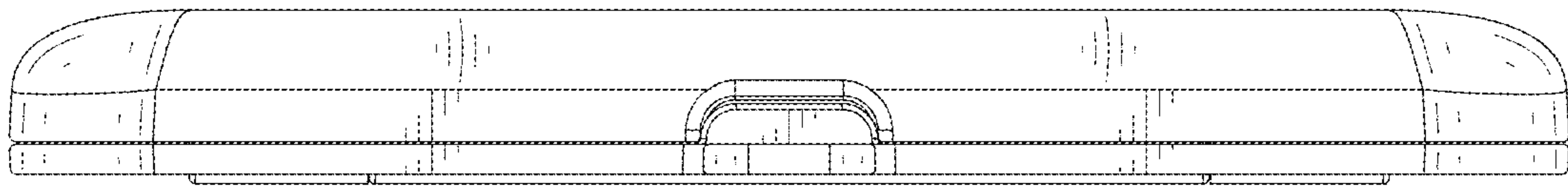

FIG.7



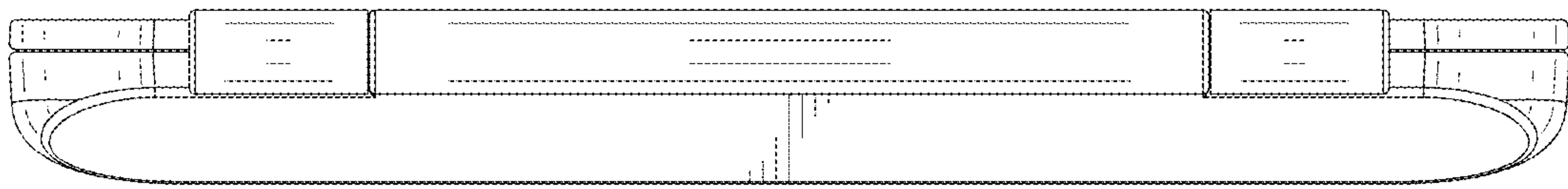

FIG.8