



US00D934539S

(12) **United States Design Patent**
Louboutin

(10) **Patent No.:** **US D934,539 S**

(45) **Date of Patent:** **** Nov. 2, 2021**

(54) **SOLE FOR FOOTWEAR**

(71) Applicant: **Christian Louboutin**, Paris (FR)

(72) Inventor: **Christian Louboutin**, Paris (FR)

(73) Assignee: **PALOÏSE SAS**, Paris (FR)

(**) Term: **15 Years**

(21) Appl. No.: **29/730,394**

(22) Filed: **Apr. 3, 2020**

(30) **Foreign Application Priority Data**

Mar. 10, 2020 (EM) 007742408

(51) **LOC (13) Cl.** **02-04**

(52) **U.S. Cl.**

USPC **D2/947**; D2/951; D2/953; D2/954

(58) **Field of Classification Search**

USPC D2/897-899, 902-908, 944, 947-955,
D2/960, 962, 969

CPC A43B 5/00; A43B 5/185; A43B 13/00;
A43B 13/02; A43B 13/04; A43B 13/12;
A43B 13/14; A43B 13/145; A43B 13/18;
A43B 13/20; A43B 13/26; A43B 1/00;
A43B 1/02; A43B 1/10; A43B 1/14

See application file for complete search history.

(56) **References Cited**

U.S. PATENT DOCUMENTS

6,108,943	A *	8/2000	Hudson	A43B 5/10 36/102
D644,420	S *	9/2011	Christopherson	D2/946
D649,753	S *	12/2011	Callahan	D2/953
D651,788	S *	1/2012	Raysse	D2/954
D652,201	S *	1/2012	Vestuti	D2/946
D674,997	S *	1/2013	Callahan	D2/947
D682,522	S *	5/2013	Raysse	D2/956
D685,984	S *	7/2013	Raysse	D2/954

D699,420	S *	2/2014	Teteriatnikov	D2/947
D711,636	S *	8/2014	Christensen	D2/954
D719,329	S *	12/2014	Smith	D2/954
D722,426	S *	2/2015	Davis	D2/953
D730,638	S *	6/2015	Christensen	D2/954
D734,601	S *	7/2015	Montross	D2/955
D748,384	S *	2/2016	Raysse	D2/954
D764,782	S *	8/2016	Hardigan	D2/960
D794,294	S *	8/2017	Robusti	D2/954
D816,965	S *	5/2018	Christopherson	D2/960
D841,959	S *	3/2019	Dean	D2/956
D852,481	S *	7/2019	Liu	D2/957
D858,063	S *	9/2019	Retelle	D2/956
D858,064	S *	9/2019	O'Shea	D2/956
D860,618	S *	9/2019	Keller	D2/962
D862,857	S *	10/2019	Boudreau	D2/957
D874,803	S *	2/2020	Spring	D2/960
D883,634	S *	5/2020	Xanthos	D2/959

(Continued)

Primary Examiner — Elizabeth J Oswecki

Assistant Examiner — Yelizaveta Y Masalimova

(74) *Attorney, Agent, or Firm* — Fross Zelnick Lehrman & Zissu, P.C.; Charles T. J. Weigell, Esq.

(57) **CLAIM**

The ornamental design for a sole for footwear, as shown and described.

DESCRIPTION

FIG. 1 is a front perspective view of a sole for footwear showing my new design;
FIG. 2 is a front view thereof;
FIG. 3 is a back view thereof;
FIG. 4 is a right side view thereof;
FIG. 5 is a left side view thereof;
FIG. 6 is a top view thereof;
FIG. 7 is a bottom view thereof; and,
FIG. 8 is a bottom perspective view thereof.
The broken lines in the drawings illustrate unclaimed subject matter and form no part of the claimed design.

1 Claim, 6 Drawing Sheets

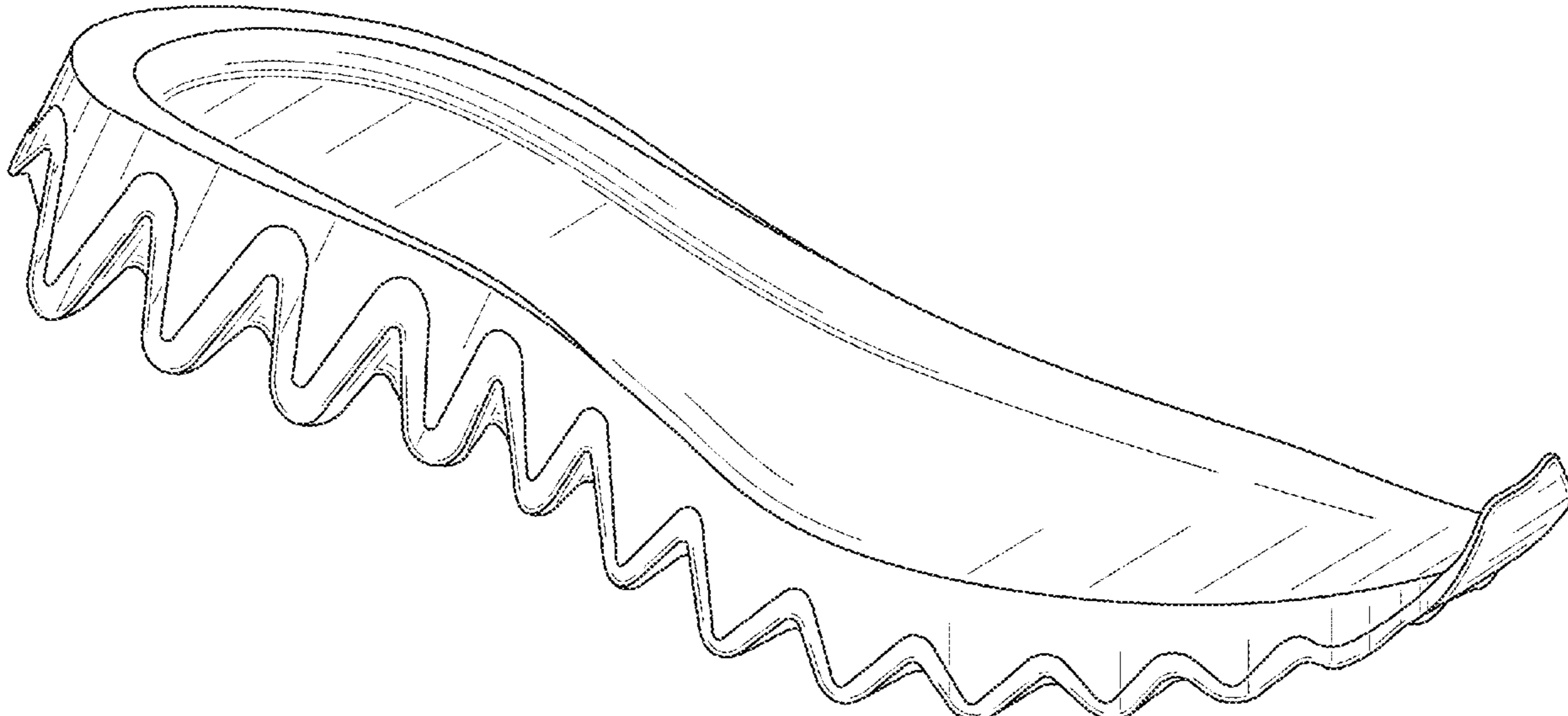

(56)

References Cited

U.S. PATENT DOCUMENTS

D889,094 S * 7/2020 Matis D2/956
D896,484 S * 9/2020 Hardigan D2/947
D906,650 S * 1/2021 Spring D2/947
2001/0042321 A1* 11/2001 Tawney A43B 13/20
36/29
2007/0209230 A1* 9/2007 Dillon A43B 13/183
36/25 R
2008/0276490 A1* 11/2008 Holt A43B 17/03
36/28
2011/0277347 A1* 11/2011 Monfils A43B 13/20
36/29
2012/0167416 A1* 7/2012 Christensen A43B 3/0057
36/103
2014/0033573 A1* 2/2014 Wills A43B 3/246
36/103
2014/0223777 A1* 8/2014 Whiteman A43B 13/14
36/102
2016/0051009 A1* 2/2016 Kormann B22F 10/20
36/103
2016/0255911 A1* 9/2016 Fujita A43B 13/125
2017/0224053 A1* 8/2017 Truelsen A43B 3/0078
2020/0107611 A1* 4/2020 Welliver A43B 13/37
2020/0146397 A1* 5/2020 Coupe G06T 19/00
2020/0154825 A1* 5/2020 Case A43B 13/188
2020/0154826 A1* 5/2020 Case A43B 13/206
2020/0305541 A1* 10/2020 Yahata A43B 13/223

* cited by examiner



FIG. 1

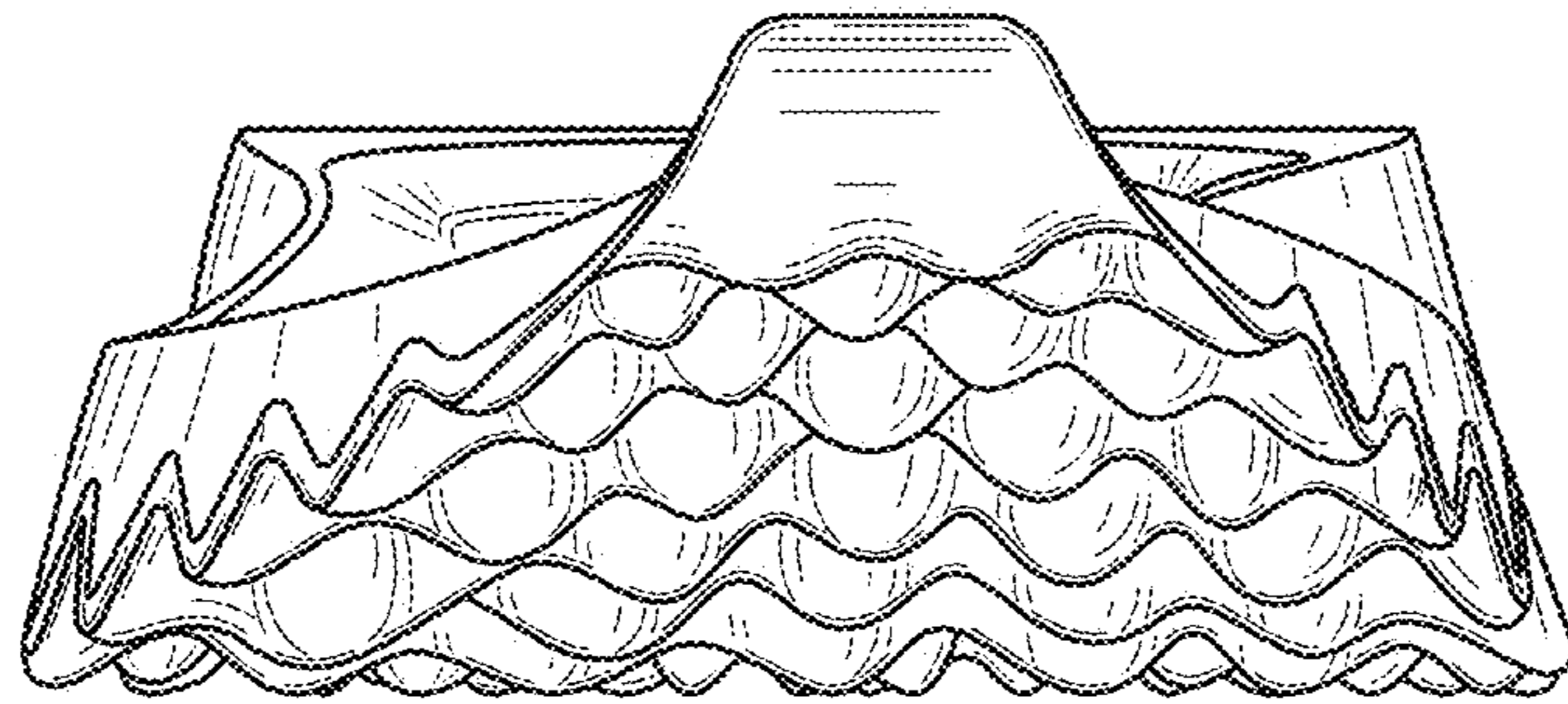

FIG. 2

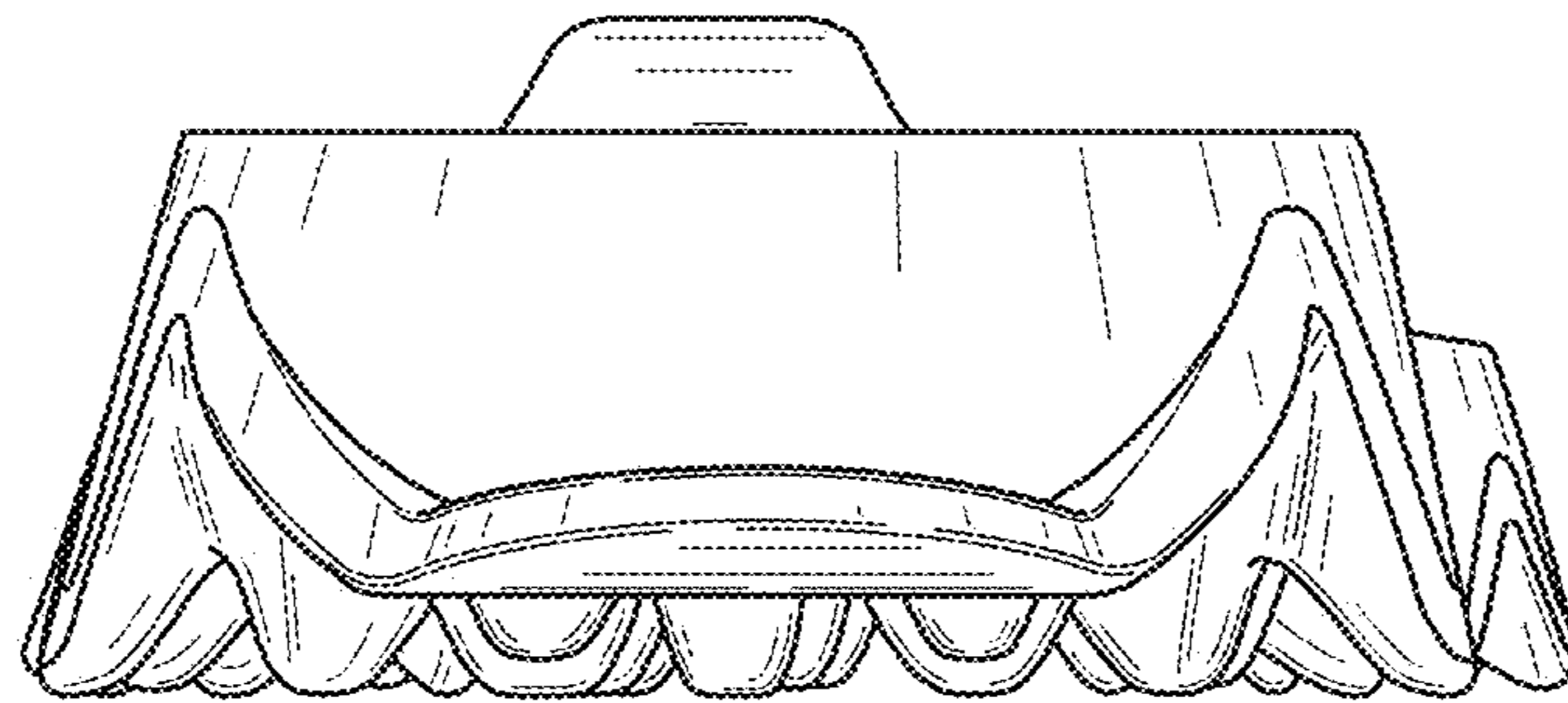

FIG. 3

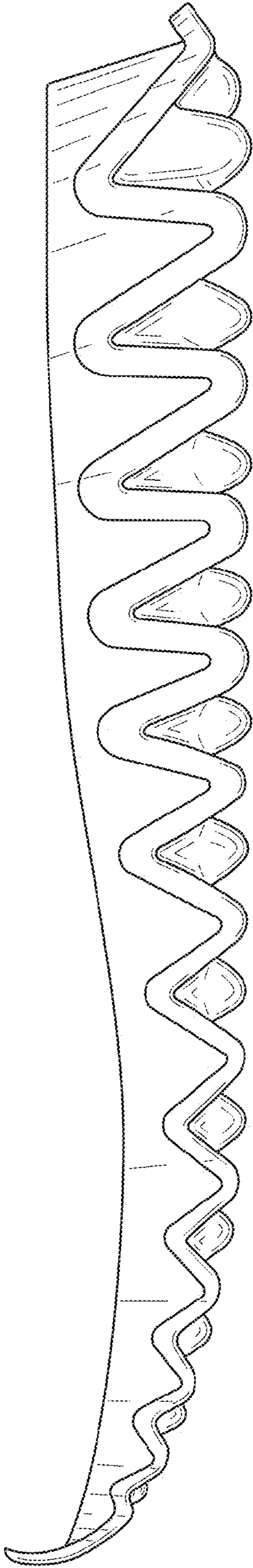

FIG. 4

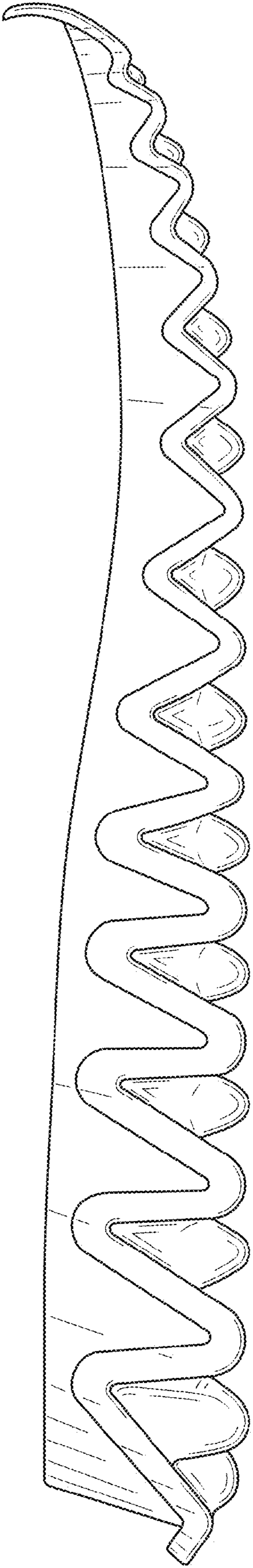

FIG. 5

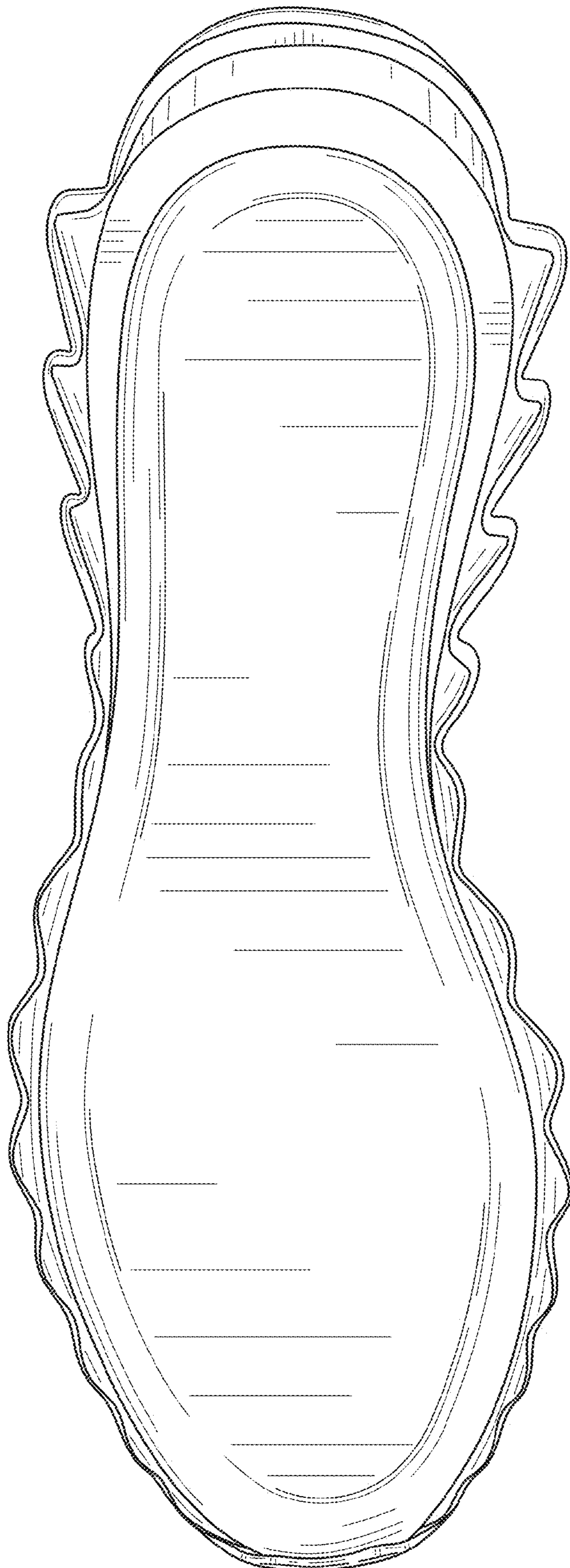

FIG. 6

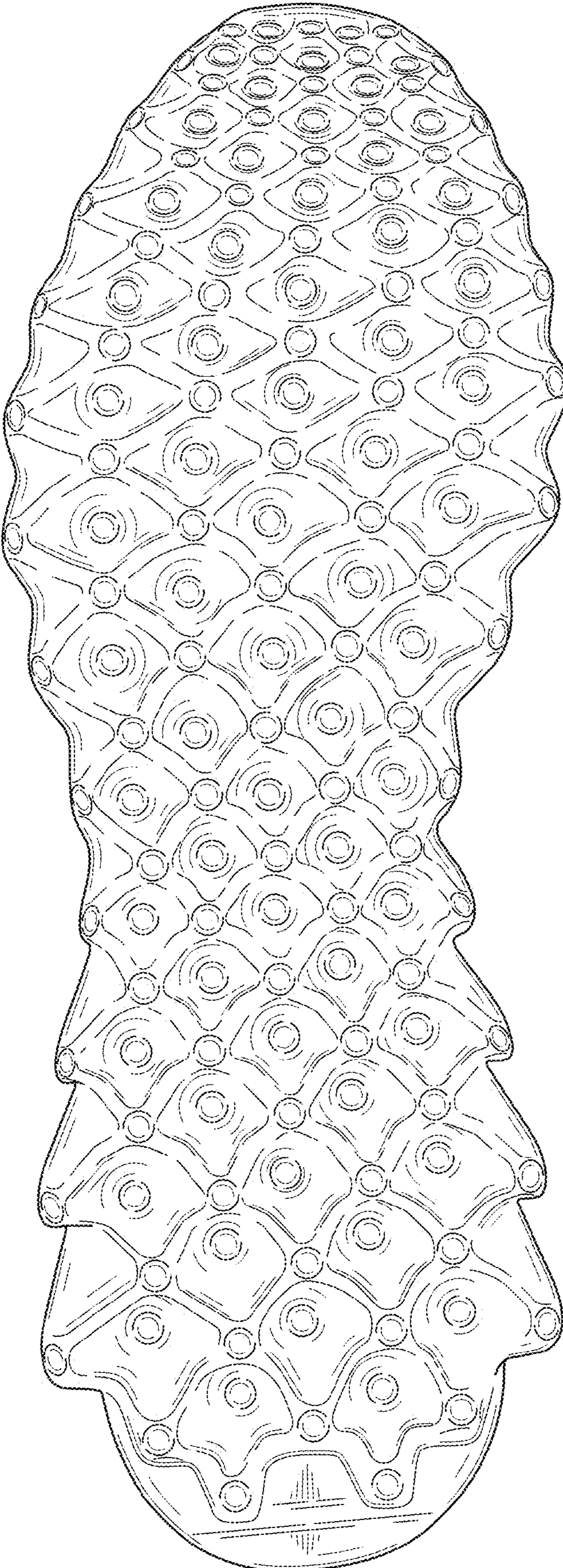

FIG. 7

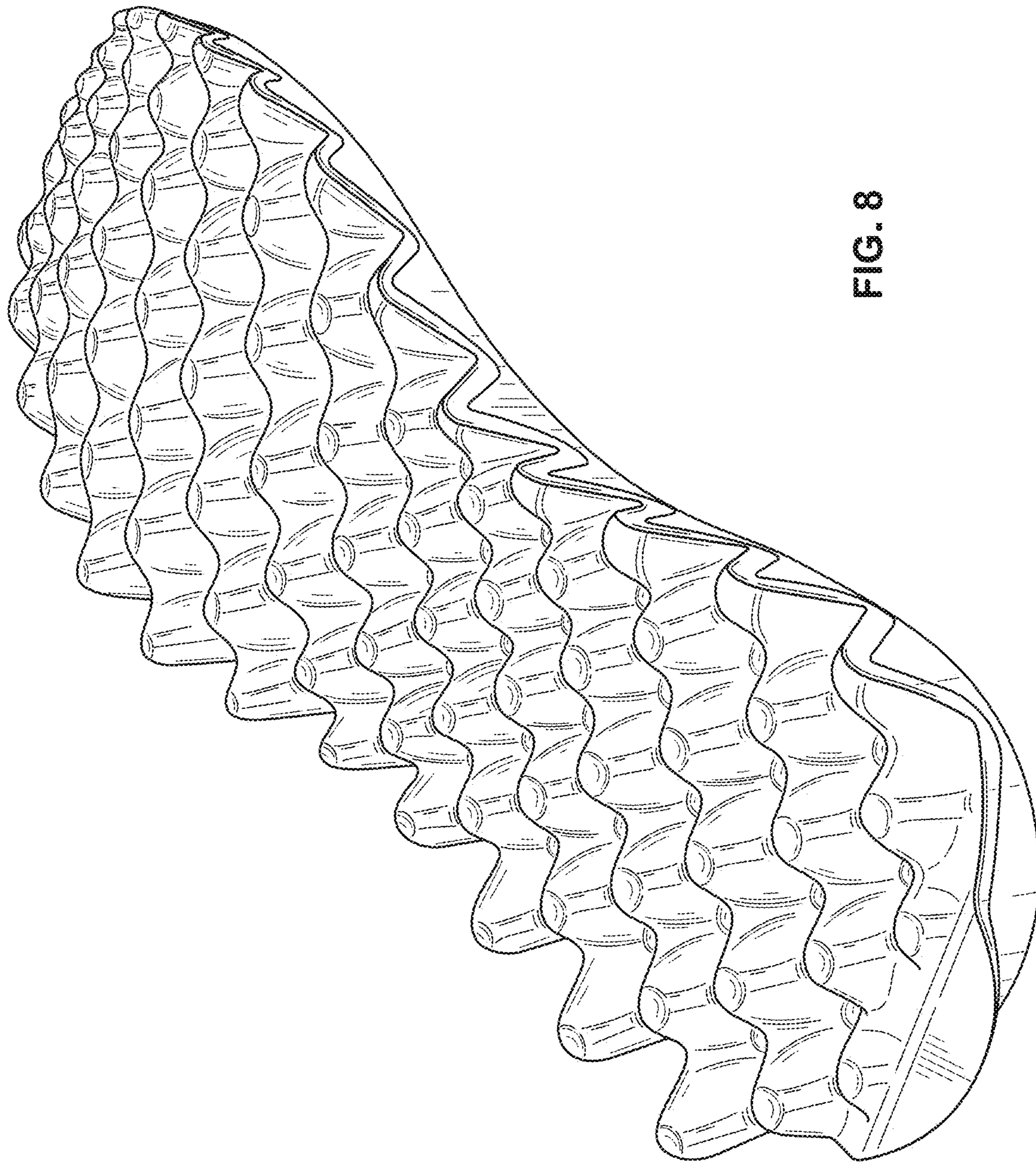

FIG. 8