

US00D934504S

(12) **United States Design Patent** (10) **Patent No.:** **US D934,504 S**
Huerta et al. (45) **Date of Patent:** **** Oct. 26, 2021**

(54) **COSMETICS CASE**

(71) Applicant: **Pinky Rose, Inc.**, Elk Grove, CA (US)

(72) Inventors: **Michelle Huerta**, Elk Grove, CA (US);
Gina Huerta, Elk Grove, CA (US)

(73) Assignee: **PINKY ROSE, INC.**, Elk Grove, CA (US)

(**) Term: **15 Years**

(21) Appl. No.: **29/701,009**

(22) Filed: **Aug. 7, 2019**

(51) **LOC (13) Cl.** **28-03**

(52) **U.S. Cl.**
USPC **D28/83**

(58) **Field of Classification Search**
USPC D28/36, 64.1, 76-84, 85-91, 99;
D9/430-433, 435, 503-505, 722, 737,
D9/756, 759, 529; D3/295; D19/103,
D19/106, 112; D15/90
CPC A45D 33/006; A45D 33/003; A45D
33/04-33; A45D 33/025; A45D 33/02;
A45D 33/20; A45D 33/22; A45D 33/24;
A45D 33/26; A45D 33/28; A45D 33/18;
(Continued)

(56) **References Cited**

U.S. PATENT DOCUMENTS

5,191,972 A * 3/1993 Helzer A47G 1/12
206/0.8
D386,615 S * 11/1997 Minami D3/284
(Continued)

OTHER PUBLICATIONS

Stormy Palette First Impression _ Pinky Rose Cosmetics X Riley
Rose—YouTube, published on Jan. 8, 2020, retrieved on Aug. 6,

2020, retrieved from the Internet URL: <https://www.youtube.com/watch?v=RhfAWDJZYZE>.*

(Continued)

Primary Examiner — Jennifer Rivard

Assistant Examiner — Alison M Ofstun

(74) *Attorney, Agent, or Firm* — SoCal IP Law Group
LLP; Jonathan Pearce

(57) **CLAIM**

The ornamental design of a cosmetic case, as shown and described.

DESCRIPTION

A portion of the disclosure of this patent document contains material which is subject to copyright protection. This patent document may show and/or describe matter which is or may become trade dress of the owner. The copyright and trade dress owner has no objection to the facsimile reproduction by anyone of the patent disclosure as it appears in the Patent and Trademark Office patent files or records, but otherwise reserves all copyright and trade dress rights whatsoever.

FIG. 1 is a front, top, and left perspective view of a first embodiment of a cosmetic case.

FIG. 2 is a front elevation view thereof;

FIG. 3 is a rear elevation view thereof;

FIG. 4 is a top plan view thereof;

FIG. 5 is a bottom plan view thereof;

FIG. 6 is a left side elevation view thereof;

FIG. 7 is a right side elevation view thereof;

FIG. 8 is a front, top, and left perspective view of a second embodiment of a cosmetics case;

FIG. 9 is a front elevation view thereof;

FIG. 10 is a rear elevation view thereof;

FIG. 11 is a top plan view thereof;

FIG. 12 is a bottom plan view thereof;

FIG. 13 is a left side elevation view thereof; and,

FIG. 14 is a right side elevation view thereof.

The broken lines are shown for the purpose of illustrating parts of the article that form not part of the claimed design.

1 Claim, 13 Drawing Sheets

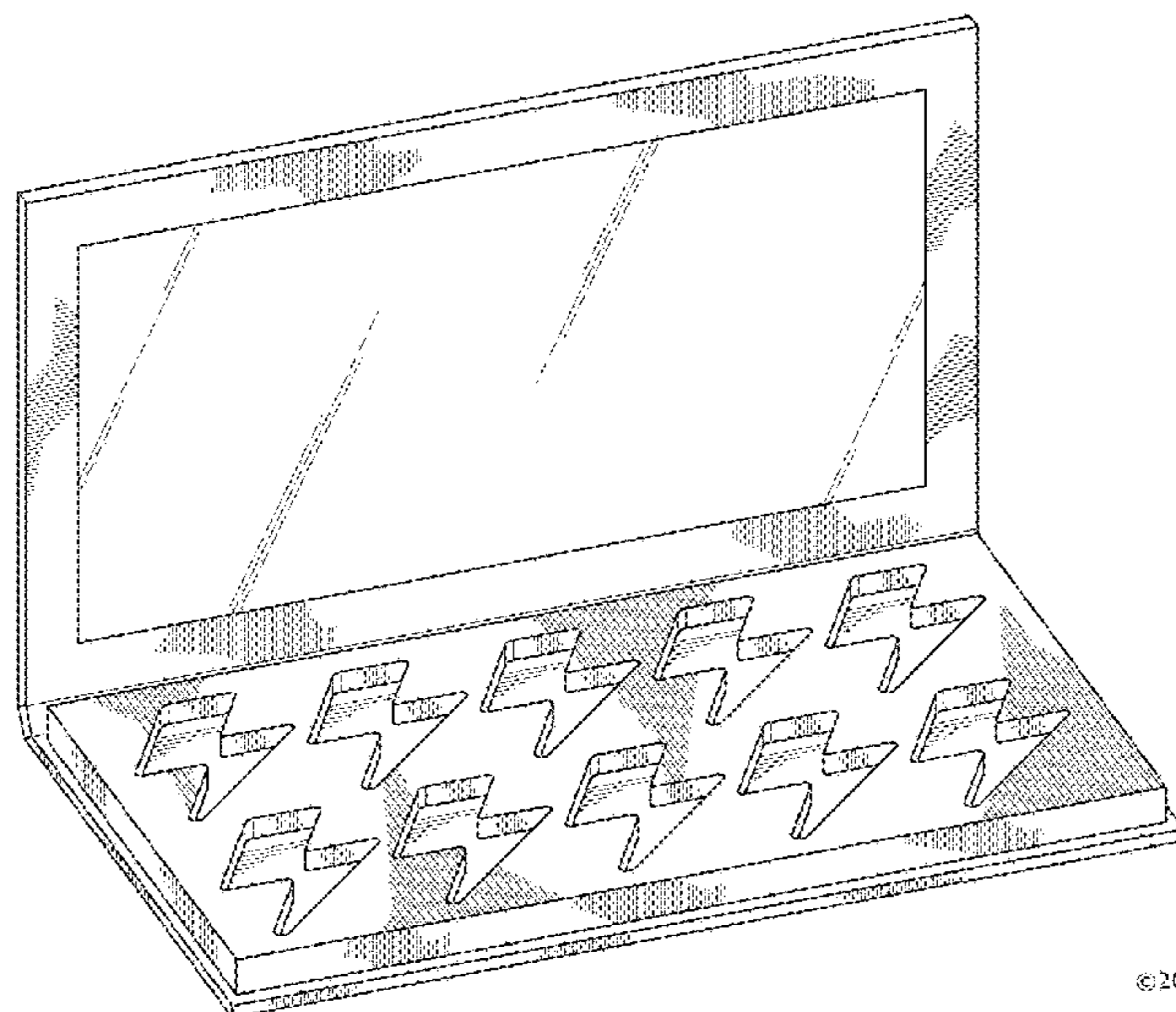

(58) **Field of Classification Search**
 CPC A45D 40/22; A45D 40/222; A45D 40/24;
 A41G 5/02
 See application file for complete search history.

(56) **References Cited**

U.S. PATENT DOCUMENTS

D642,743	S *	8/2011	Shteyssel	D28/83
D723,742	S *	3/2015	Shteyssel	D28/83
D830,637	S *	10/2018	Yoo	D28/83
D831,275	S *	10/2018	Maynard	D28/83
D837,453	S *	1/2019	Angles-D'Auriac	D28/83
2004/0003825	A1 *	1/2004	Kelly	A45D 33/008 132/301
2011/0253167	A1 *	10/2011	Shteyssel	A45D 40/24 132/314
2013/0133686	A1 *	5/2013	Shteyssel	A45D 40/24 132/314
2014/0224275	A1 *	8/2014	Peterson	A45D 40/24 132/314
2014/0299151	A1 *	10/2014	Stroud	A45D 33/20 132/315

OTHER PUBLICATIONS

Silicone Earring lightning bolt Stud Mold EM148, Make Me Mold Me, reviewed on Oct. 18, 2017, retrieved on Nov. 5, 2020, retrieved

from the Internet URL: <https://www.makememoldme.com/listing/387551954/12mm-silicone-thunder-bolt-lightning#reviews-module>.*

2018 new Novelty Christmas Weather Icons Cloudy Snowflake Lightning Dark Cloud Moon Star Sun Shape Ice Silicone Mold, retrieved on Nov. 5, 2020, retrieved from the Internet URL: <http://www.siliconekitchen-utensils.com/sale-11704634-2018-new-novelty-christmas-weather-icons-cloudy-snowflake-lightning-dark-cloud-moon-s>.*

Stormy Limited Edition Palette, Pinky Rose x Riley Rose, published on Jan. 3, 2020 on facebook.com, retrieved on Mar. 5, 2021, retrieved from the Internet URL: [https://www.facebook.com/pinkyrosecosmetics/?hc_ref=ARS3sd1aOTvGkKIWgRFaazsbRqzB4Z3vT-Gq1DZsYeslqWdiOIYDQfB5BgCirVt_Tbs&fref=nf&__xts__\[0\]=68.ARCJ9S2DALtboqYt_](https://www.facebook.com/pinkyrosecosmetics/?hc_ref=ARS3sd1aOTvGkKIWgRFaazsbRqzB4Z3vT-Gq1DZsYeslqWdiOIYDQfB5BgCirVt_Tbs&fref=nf&__xts__[0]=68.ARCJ9S2DALtboqYt_).*

Pinky Rose Cosmetics Palette—Stormy—Cosmetics Obsession, retrieved on Mar. 5, 2021, retrieved from the Internet URL: <https://cosmeticsobsession.com/en/products/pinky-rose-cosmetics-palette-stormy#description>.*

The Original Mermaid Glitter Eyeshadow Palette, Cleof, reviewed on Sep. 6, 2018 on amazon.com, retrieved on Mar. 5, 2021, retrieved from the Internet URL: <https://www.amazon.com/Original-Mermaid-Glitter-Eyeshadow-Palette/dp/B079J2CNCT>.*

* cited by examiner

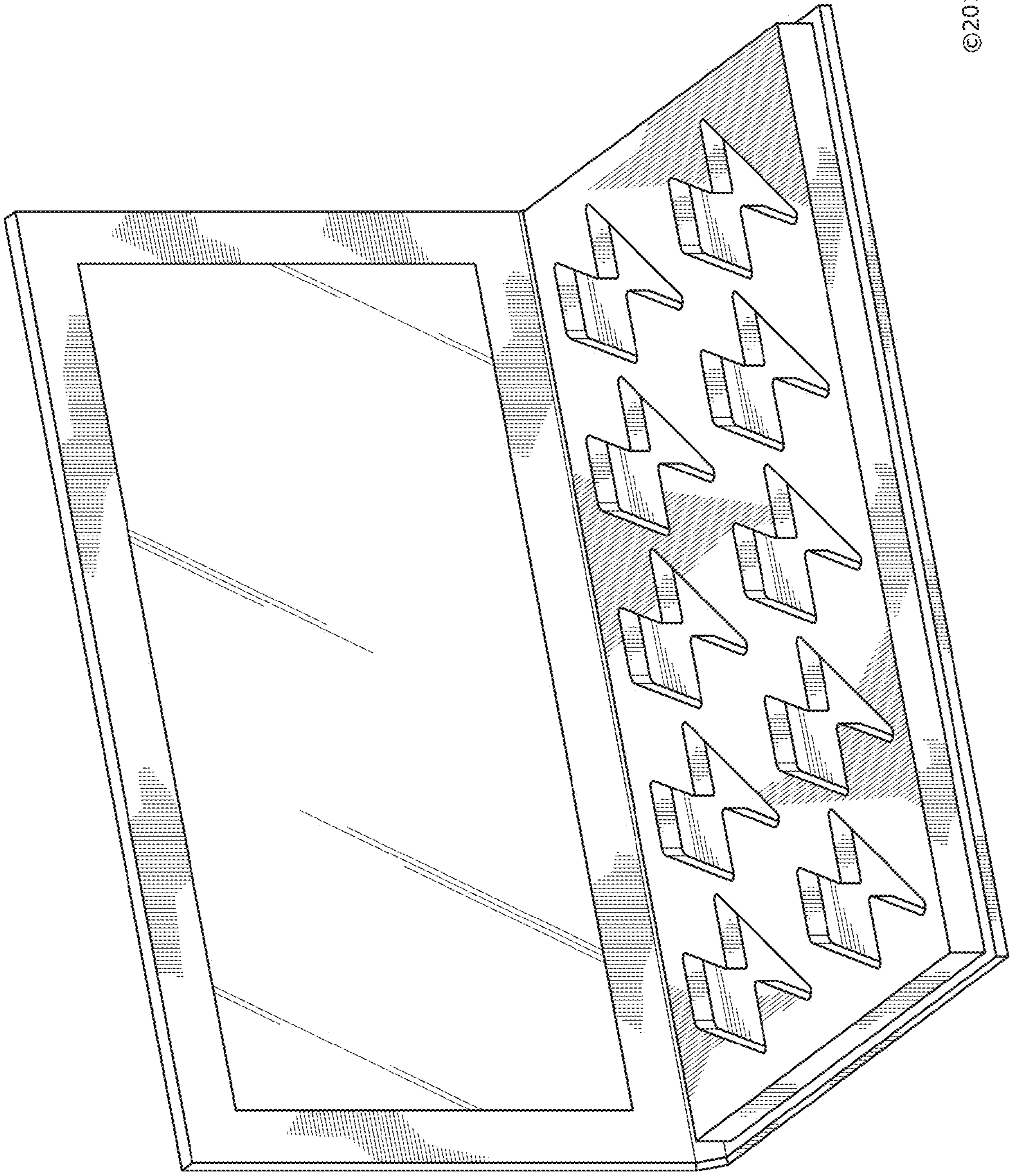

FIG. 1

©2019 Pinky Rose, Inc.

FIG. 2

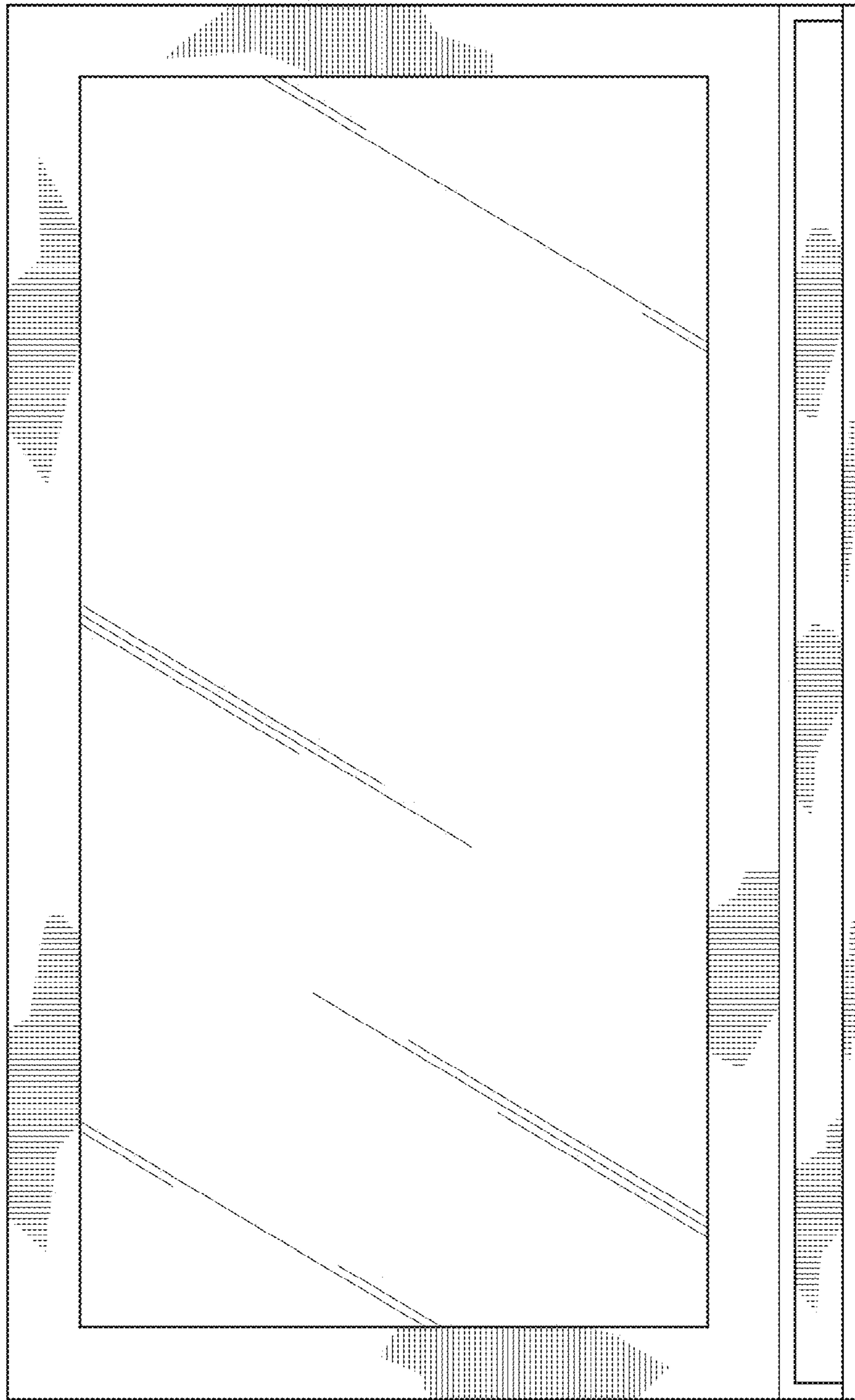

FIG. 3

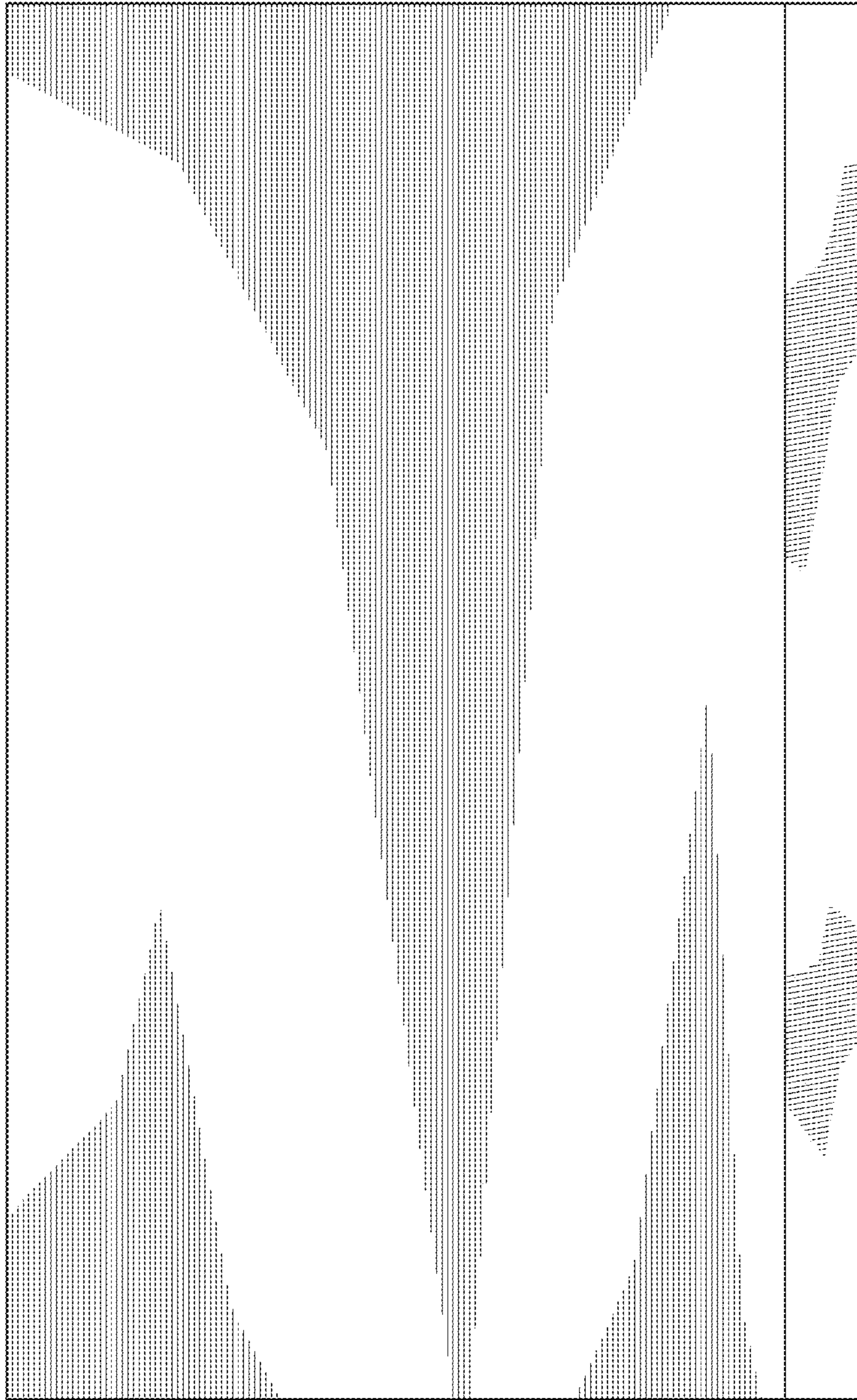

FIG. 4

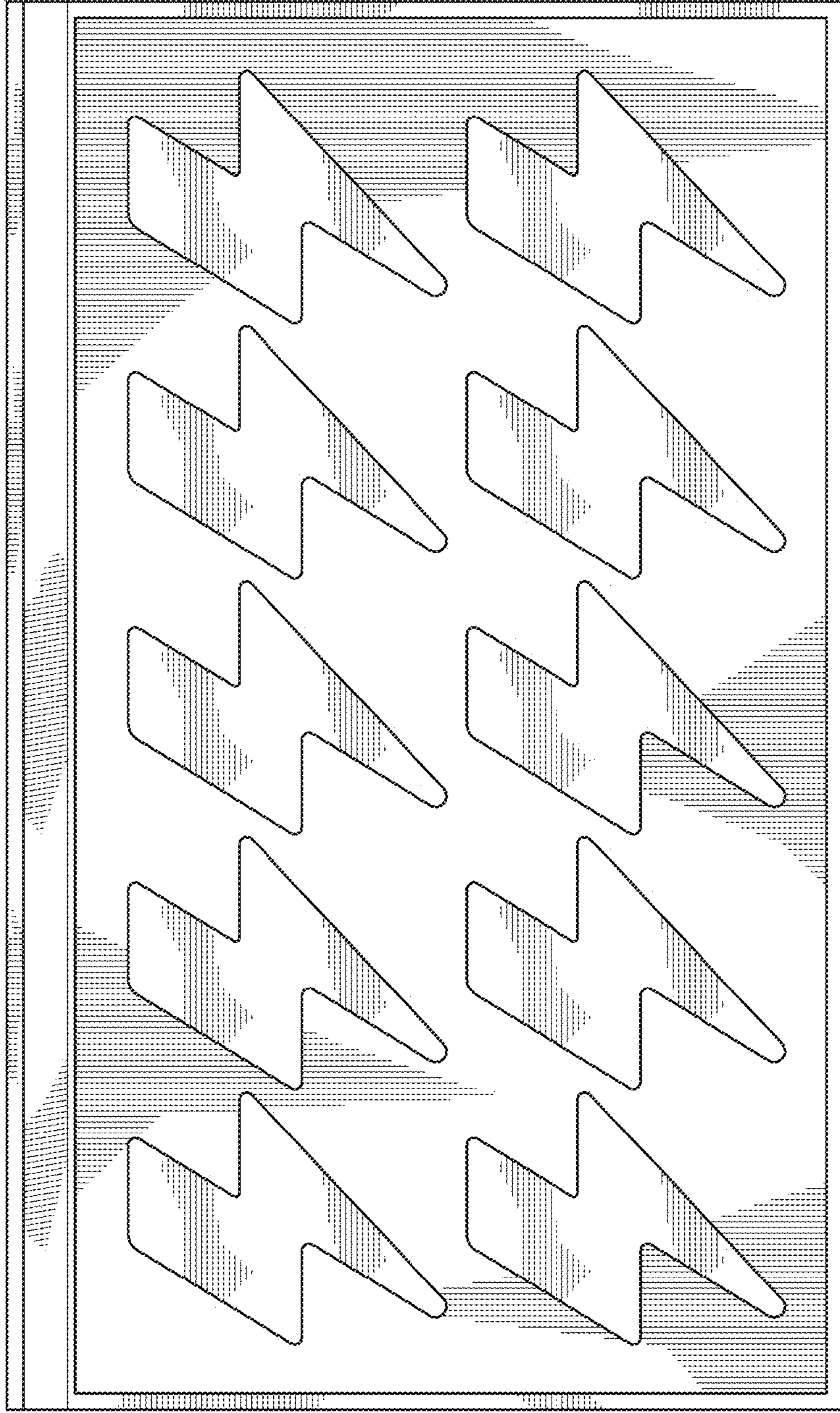

FIG. 5

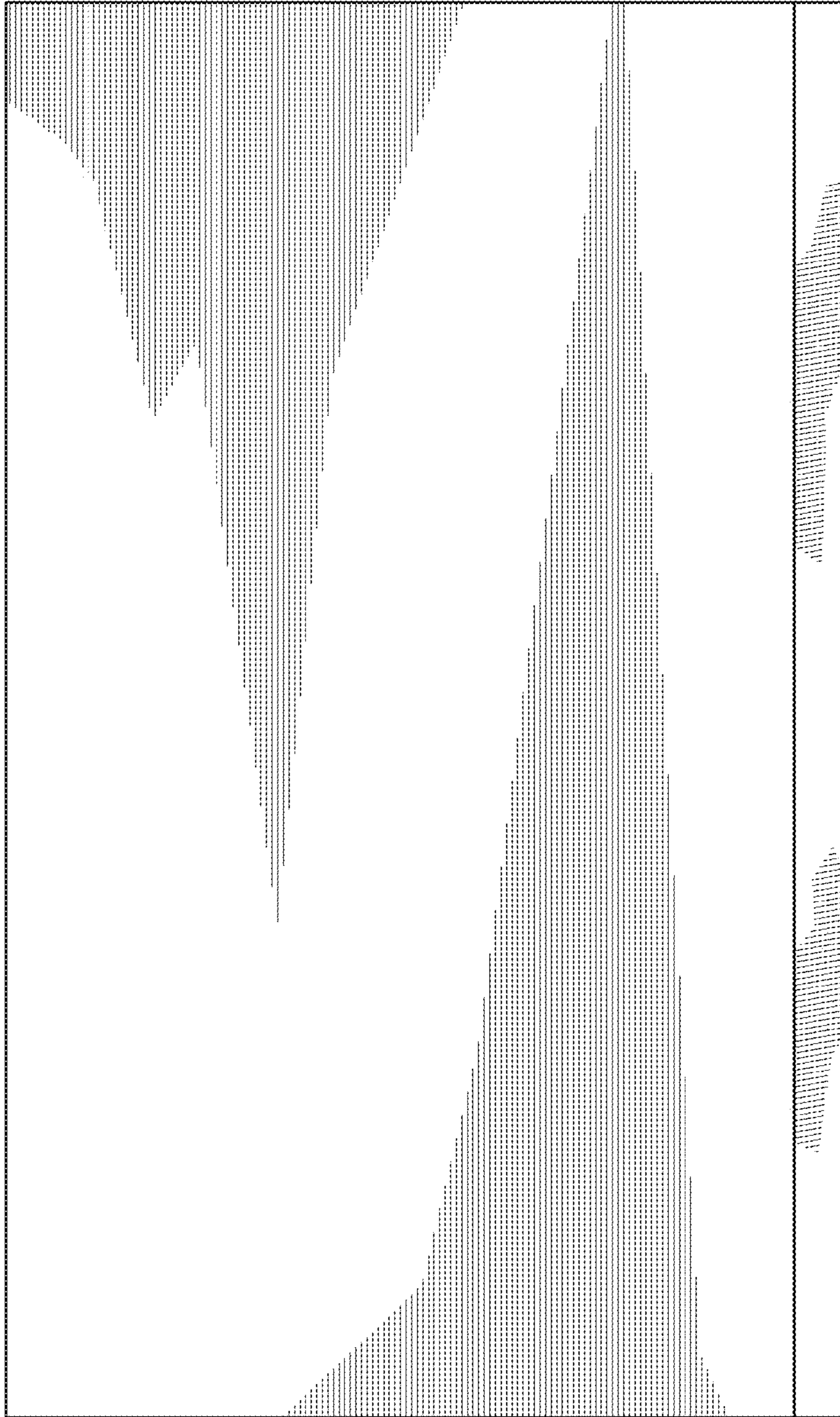
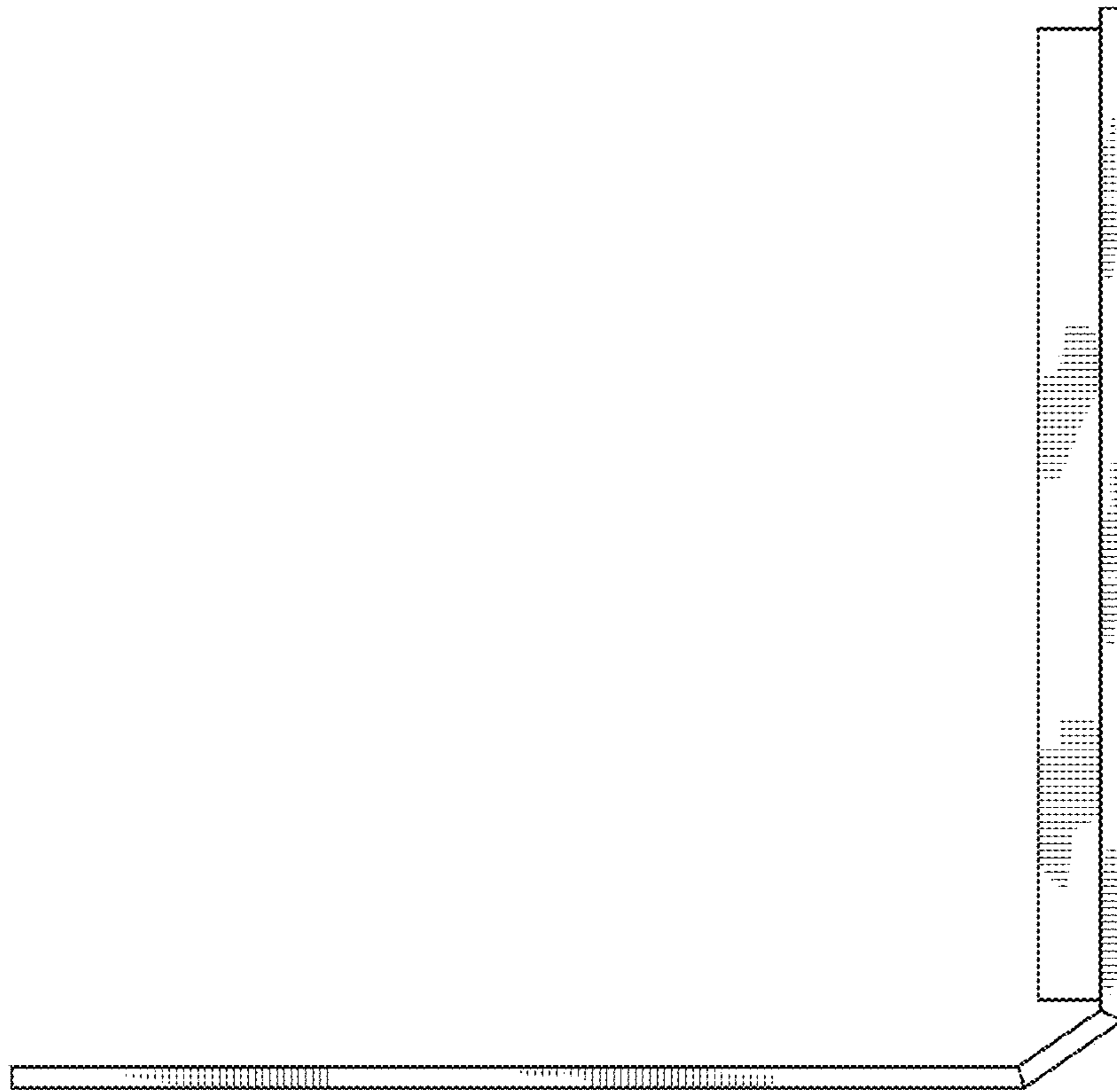
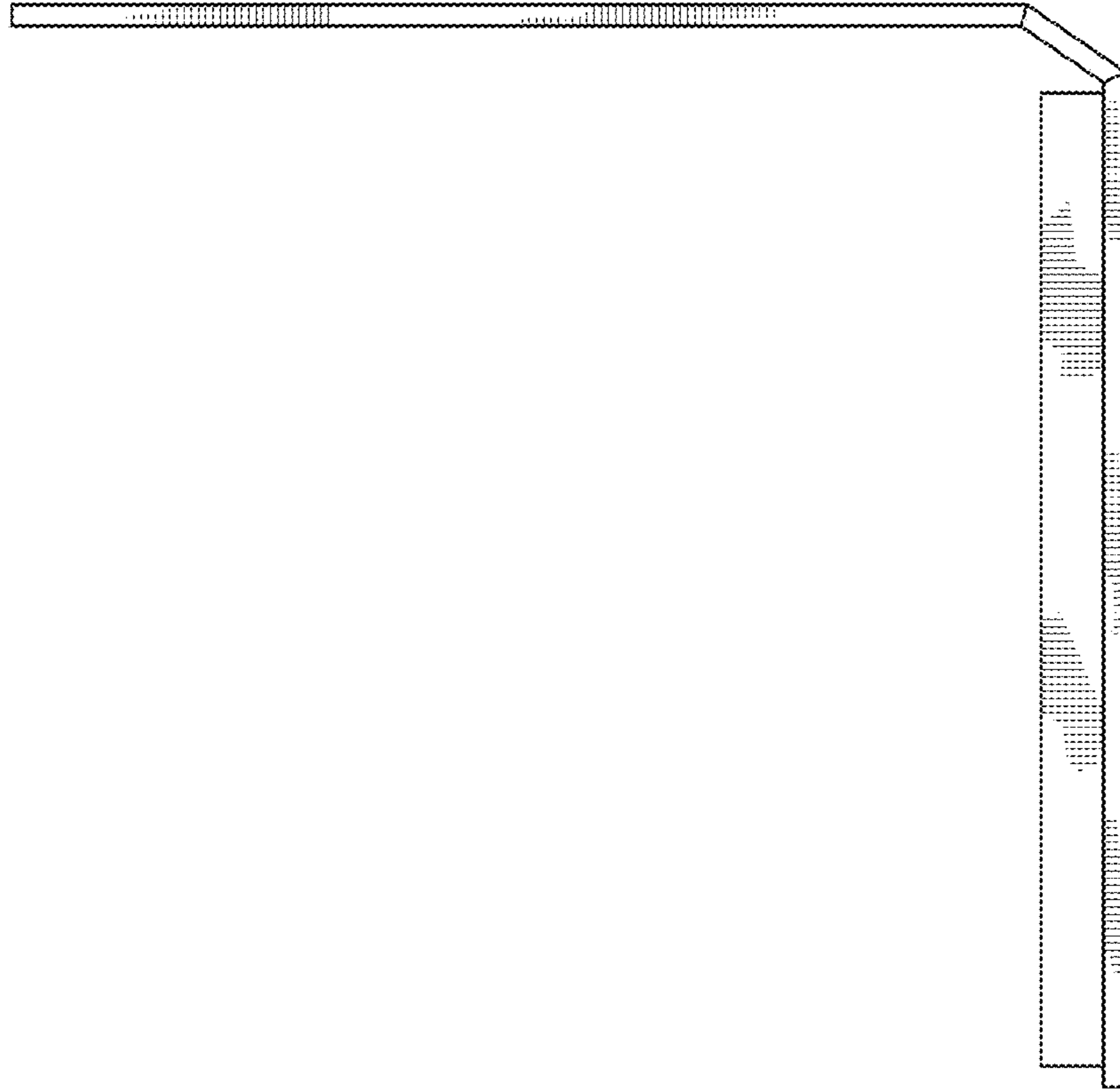

FIG. 6



©2019 Pinky Rose, Inc.

FIG. 7



©2019 Pinky Rose, Inc.

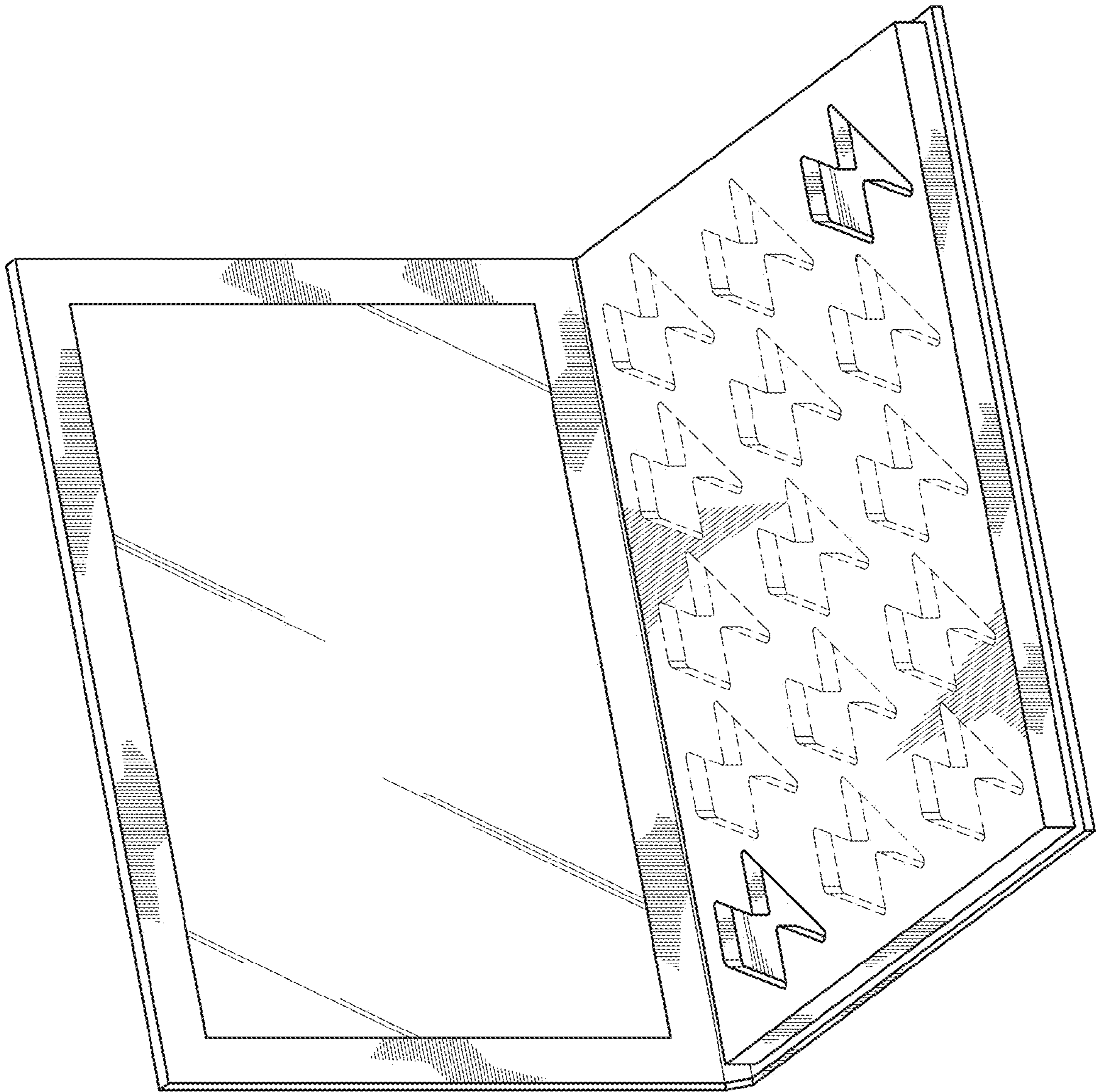

FIG. 8

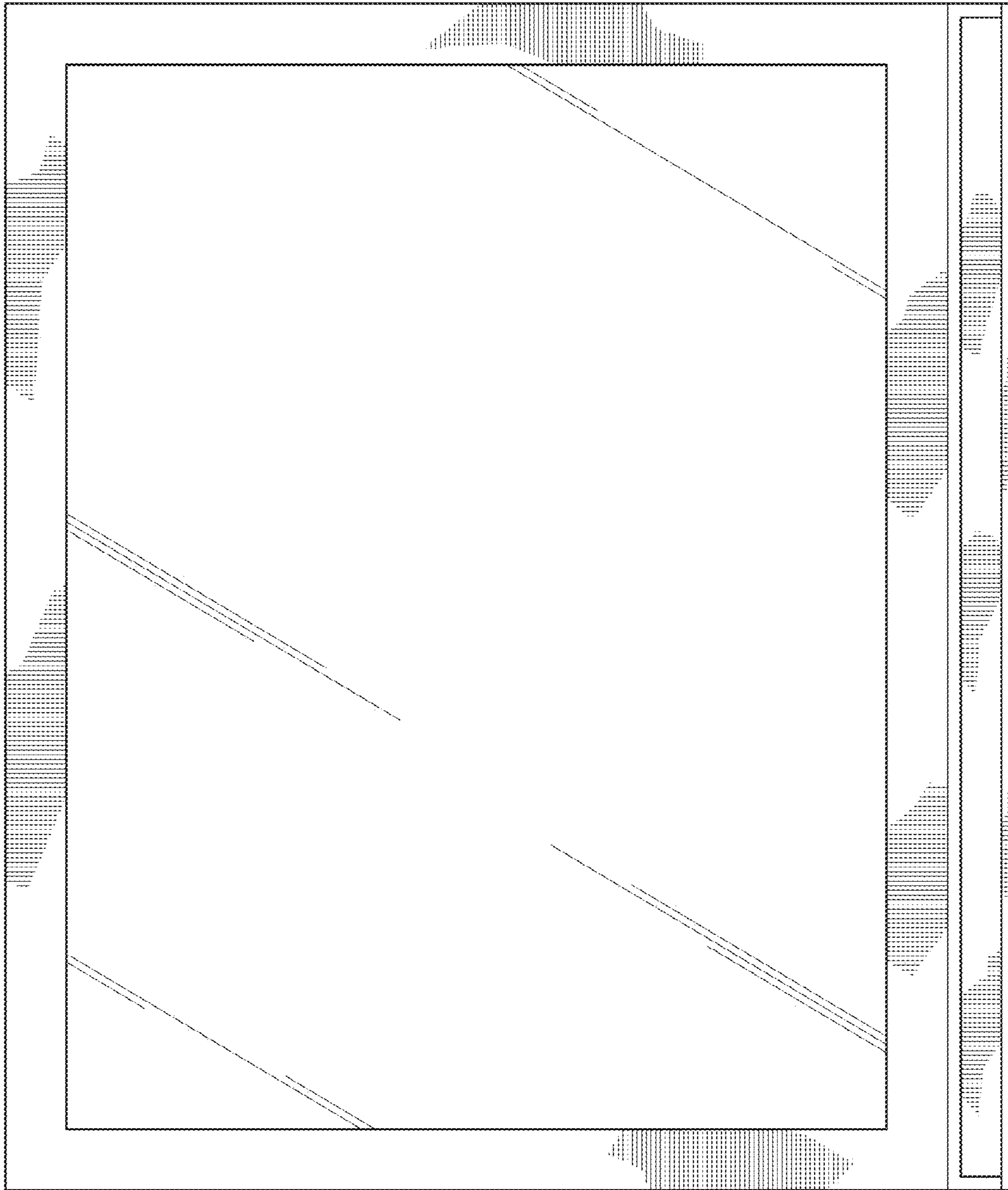

FIG. 9

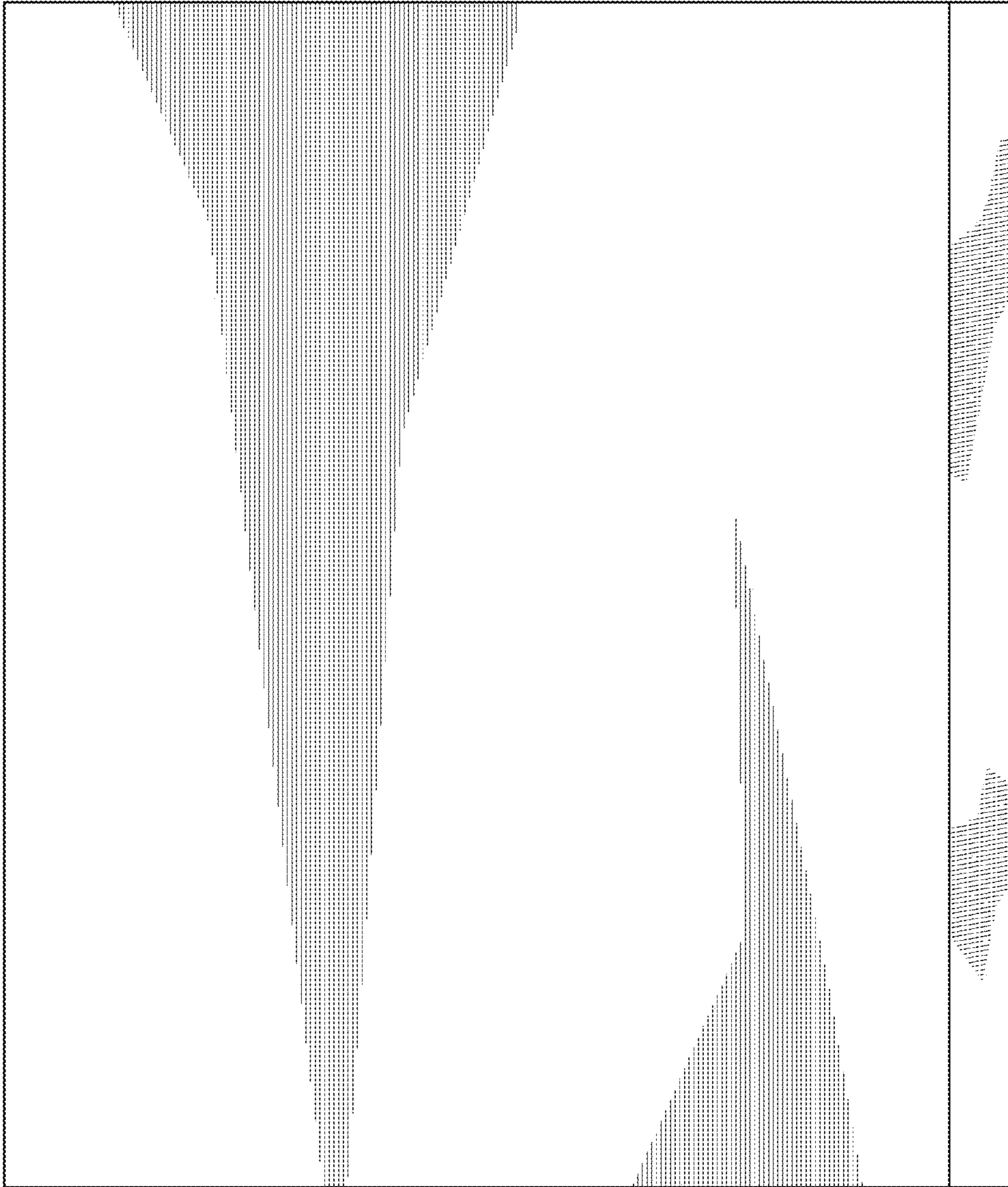

FIG. 10

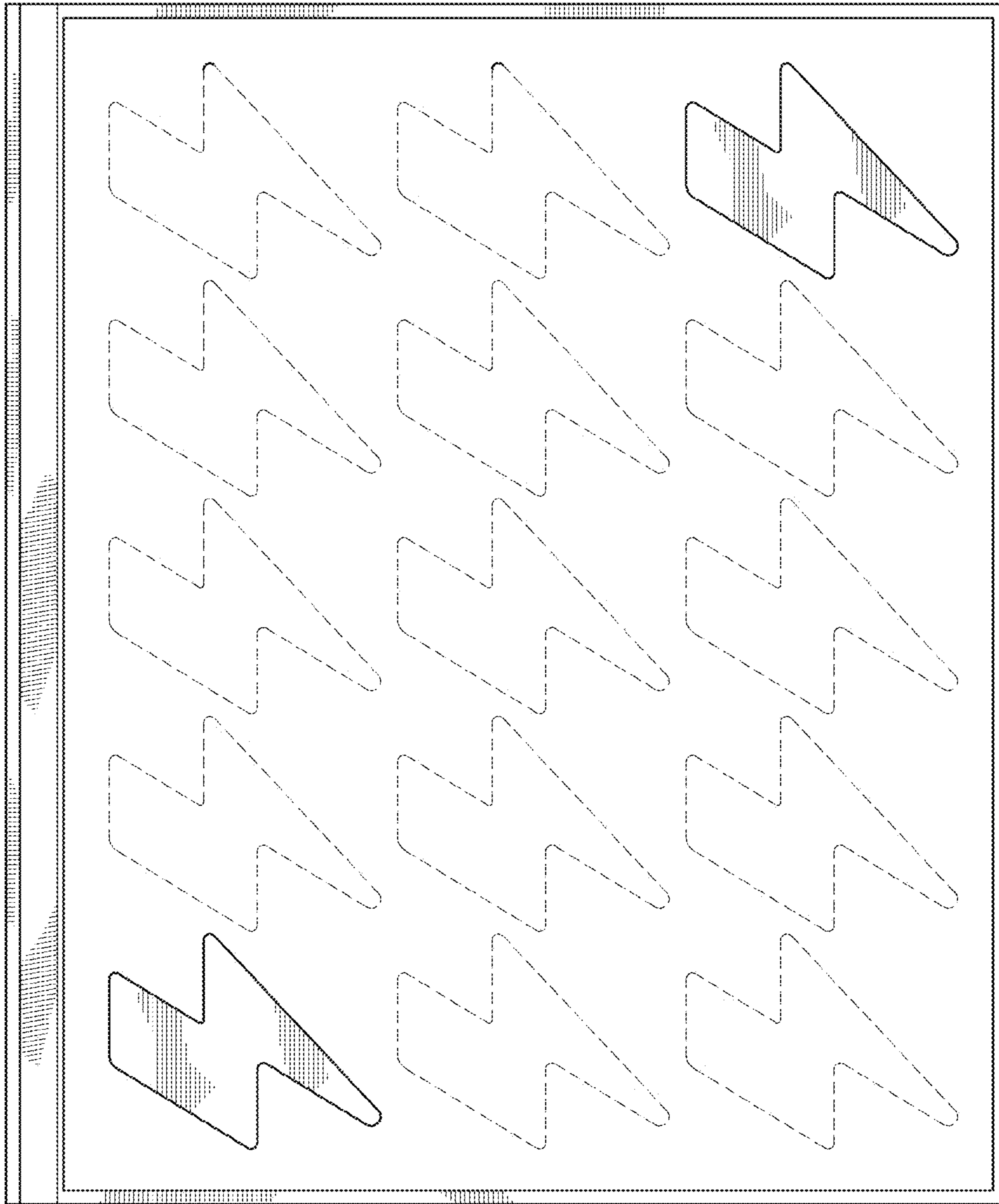

FIG. 11



©2019 Pinky Rose, Inc.

FIG. 12

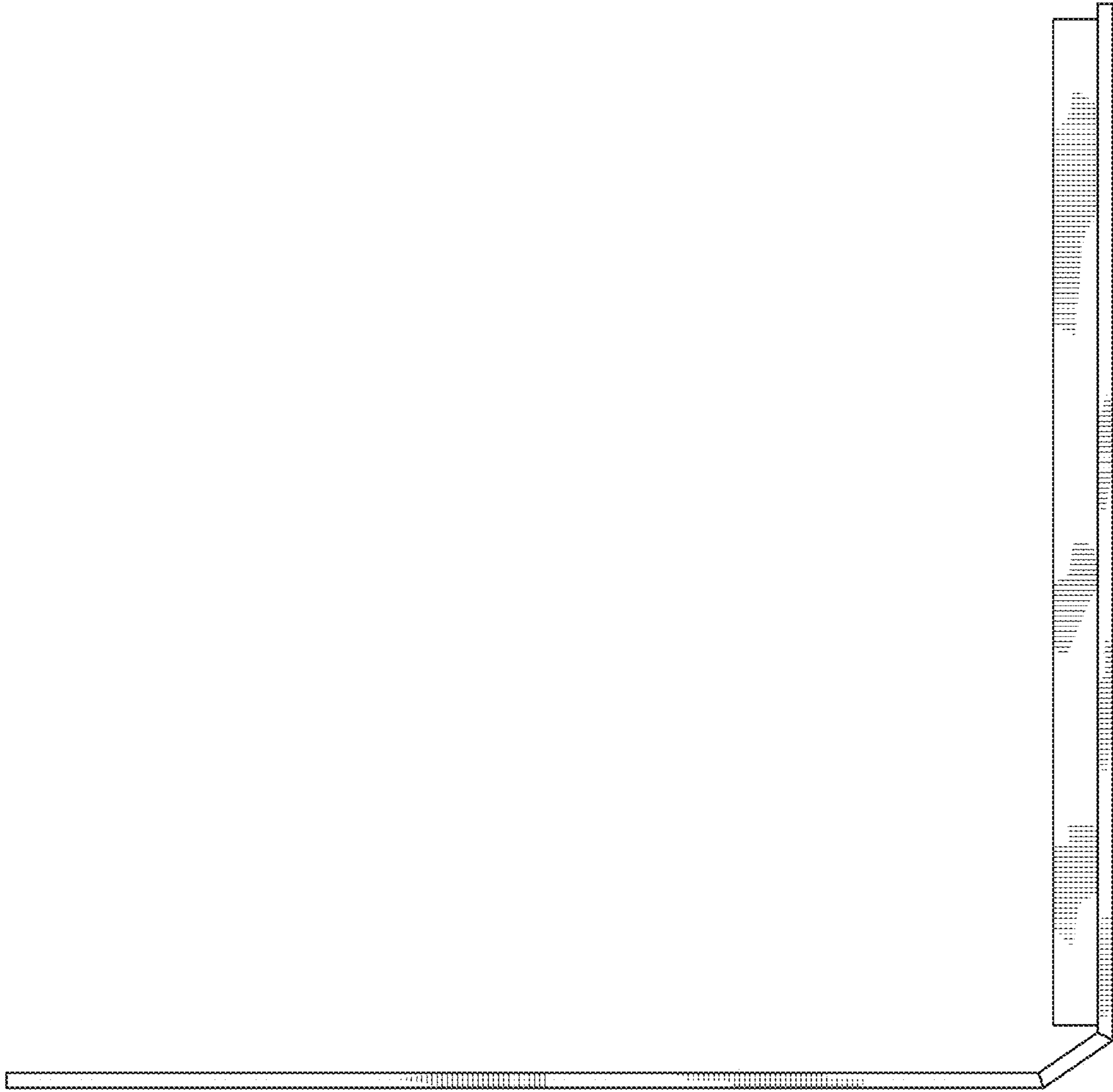
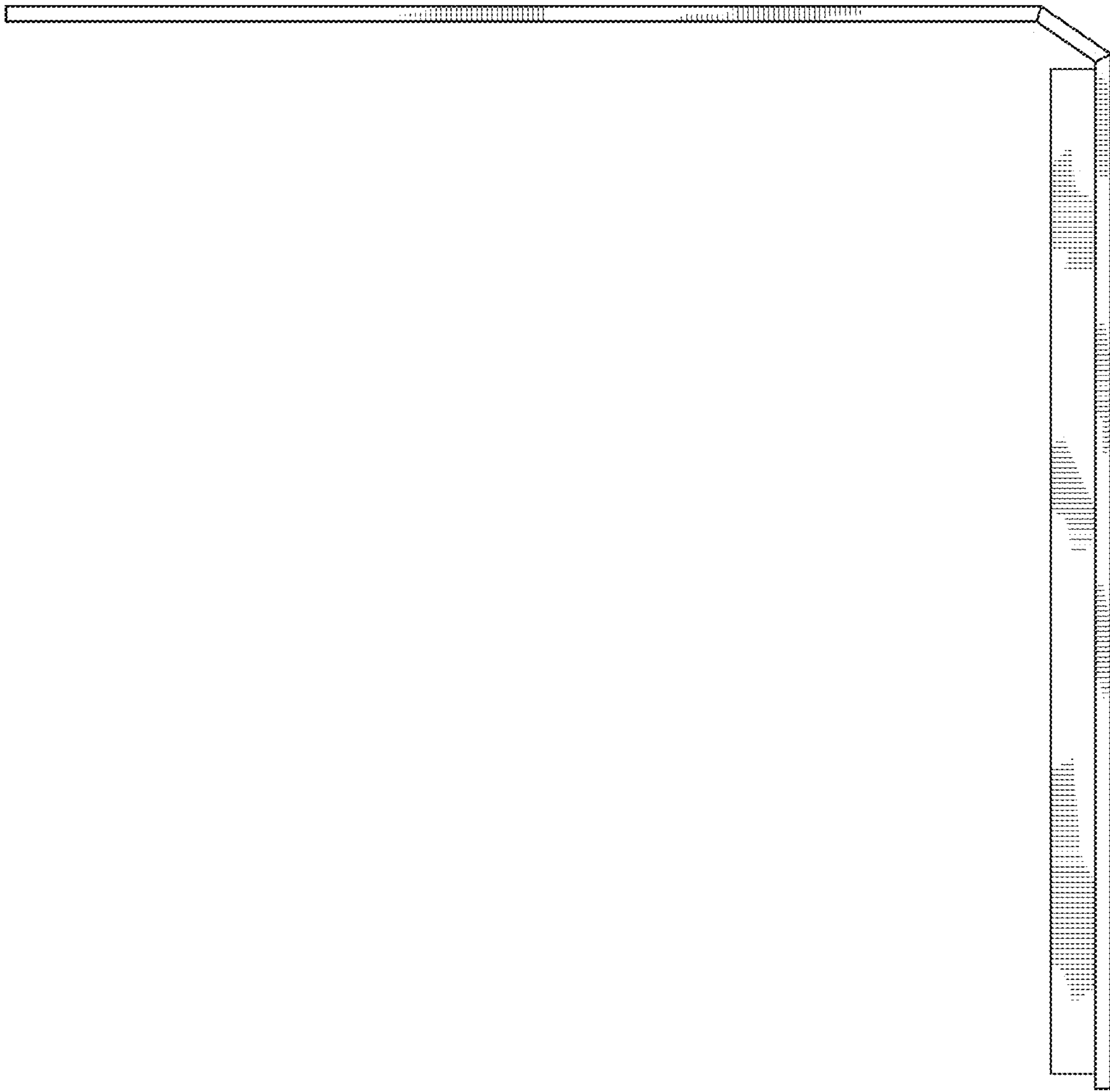

FIG. 13

©2019 Pinky Rose, Inc.



©2019 Pinky Rose, Inc.

FIG. 14