



US00D934500S

(12) **United States Design Patent** (10) **Patent No.:** **US D934,500 S**
Yang (45) **Date of Patent:** **** Oct. 26, 2021**

(54) **HAIR CURLER**
(71) Applicant: **SHENZHEN MERDA ELECTRONICS CO., LTD**, Shenzhen (CN)
(72) Inventor: **Xiao Ping Yang**, Shenzhen (CN)
(73) Assignee: **SHENZHEN MERDA ELECTRONICS CO., LTD**, Shenzhen (CN)

D899,687 S * 10/2020 Chen D28/35
D902,483 S * 11/2020 Fan D28/35
D905,333 S * 12/2020 Ng D28/35
D916,369 S * 4/2021 Huang D28/35
D919,886 S * 5/2021 Wang D28/35
D925,829 S * 7/2021 Zeng D28/35
2016/0037888 A1* 2/2016 Richmond A45D 6/02
132/211
2019/0328100 A1* 10/2019 Duan A45D 6/08
2020/0060405 A1* 2/2020 Wang A45D 1/04
2020/0196728 A1* 6/2020 Yong A45D 1/04

(**) Term: **15 Years**

* cited by examiner

Primary Examiner — Jennifer Rivard

(21) Appl. No.: **29/761,550**
(22) Filed: **Dec. 10, 2020**
(51) **LOC (13) Cl.** **28-03**
(52) **U.S. Cl.**
USPC **D28/35**
(58) **Field of Classification Search**
USPC D28/35
CPC ... A45D 1/00; A45D 1/02; A45D 1/04; A45D 1/06; A45D 1/14; A45D 1/18; A45D 1/28; A45D 2/001; A45D 2/002; A45D 2/36-2/367; A45D 6/02-6/04; A45D 2/02; A45D 2/12; A45D 2/122; A45D 2/14
See application file for complete search history.

(57) **CLAIM**

The ornamental design for a hair curler, as shown and described.

DESCRIPTION

FIG. 1 is a perspective view of a hair curler showing my new design;
FIG. 2 is another perspective view thereof;
FIG. 3 is a front elevational view thereof;
FIG. 4 is a rear elevational view thereof;
FIG. 5 is a left side elevational view thereof;
FIG. 6 is a right side elevational view thereof;
FIG. 7 is a top plan view thereof;
FIG. 8 is a bottom plan view thereof; and,
FIG. 9 is an enlarged bottom plan view of the FIG. 8.
The broken lines in the drawings depict portions of the hair curler that form no part of the claimed design.

(56) **References Cited**

U.S. PATENT DOCUMENTS

D884,968 S * 5/2020 Zhu D28/35
D892,405 S * 8/2020 Huang D28/35

1 Claim, 9 Drawing Sheets

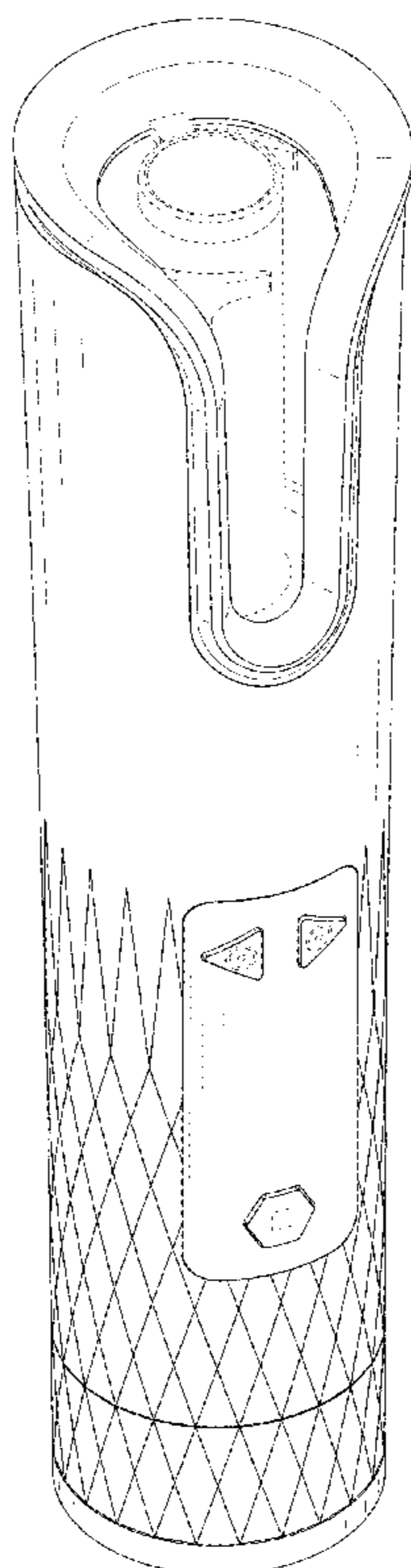

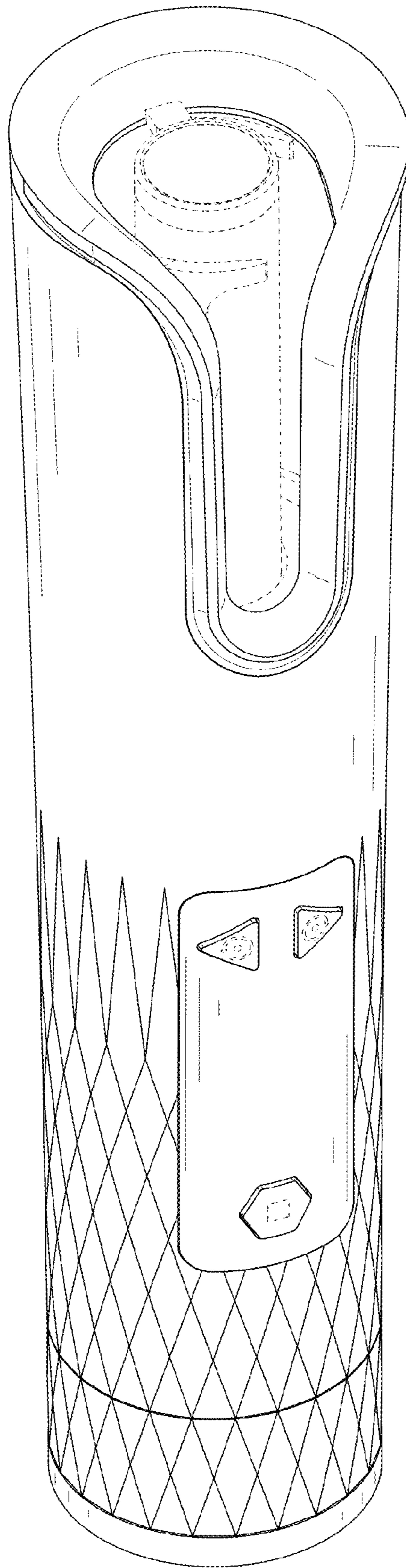

FIG. 1

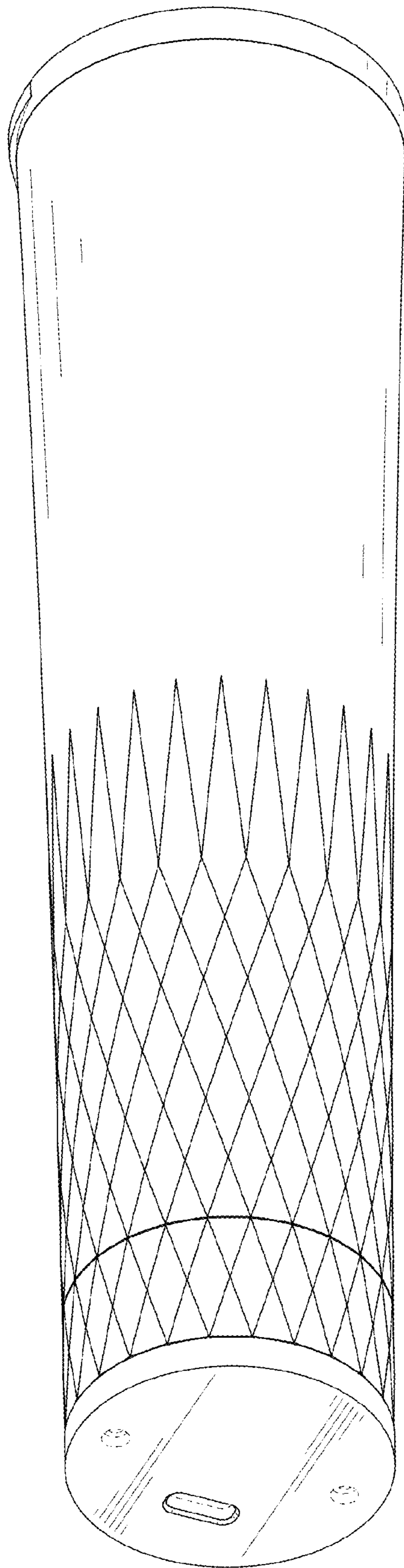

FIG. 2

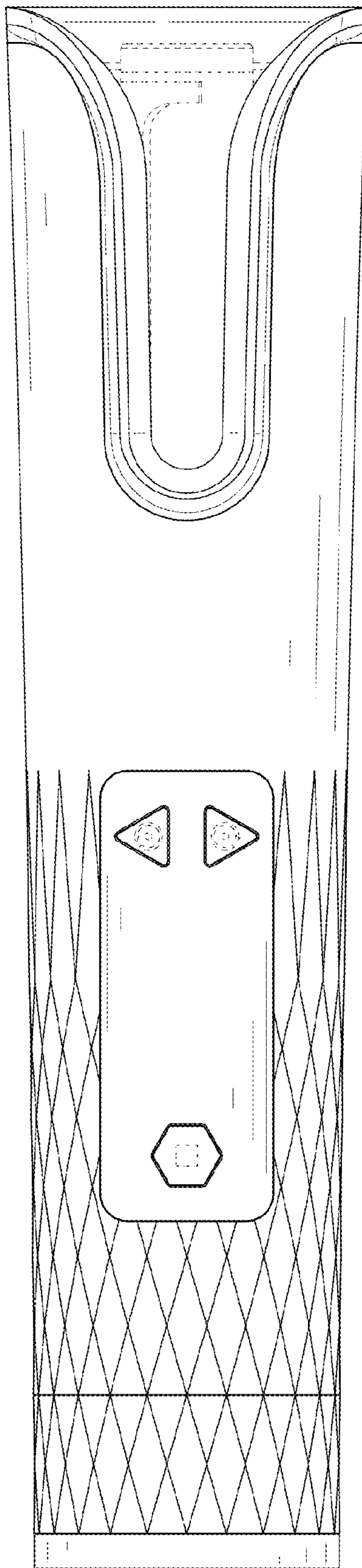

FIG. 3

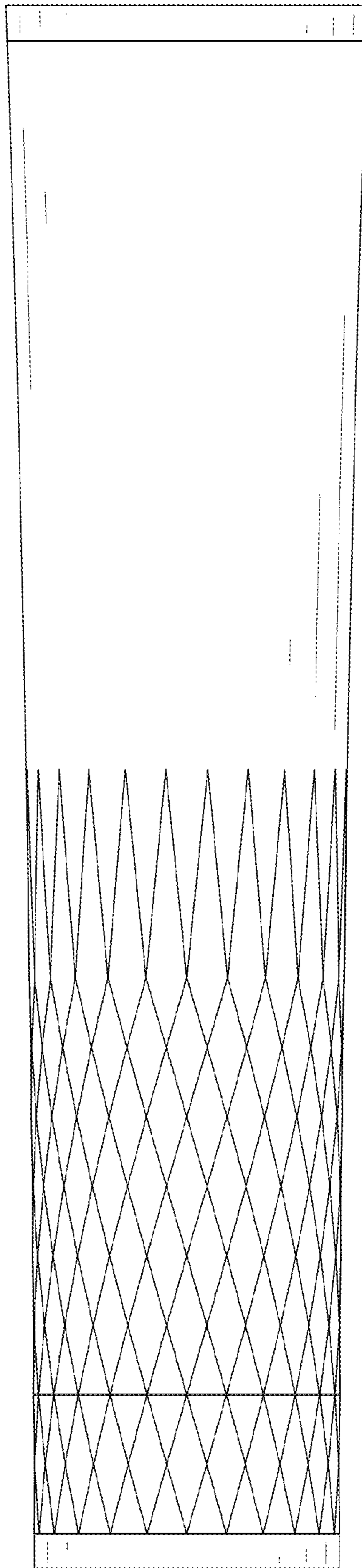

FIG. 4

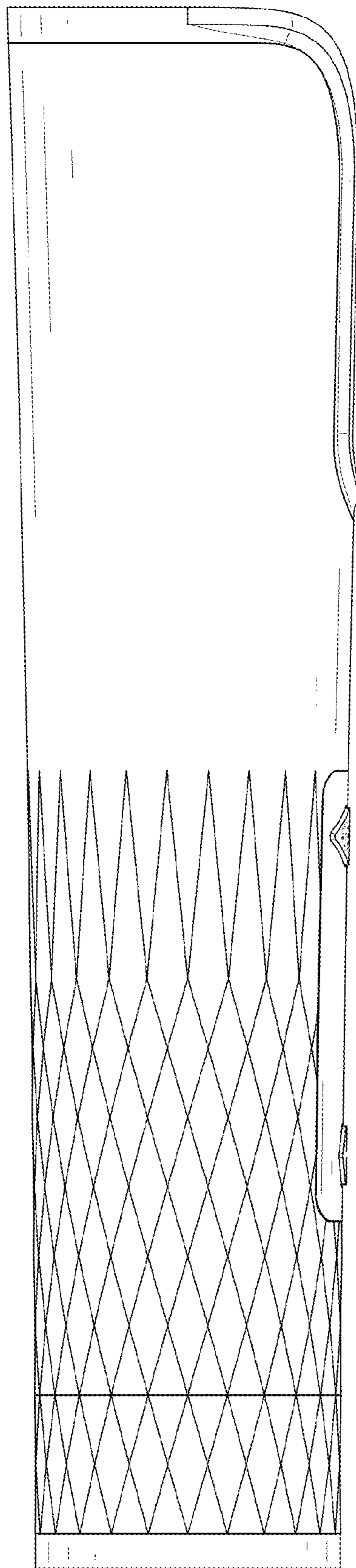

FIG. 5

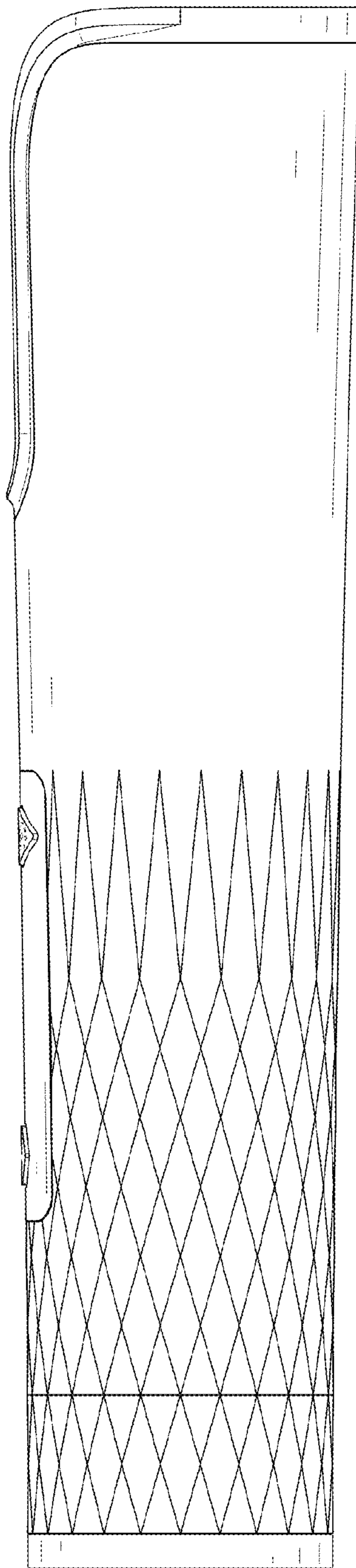

FIG. 6

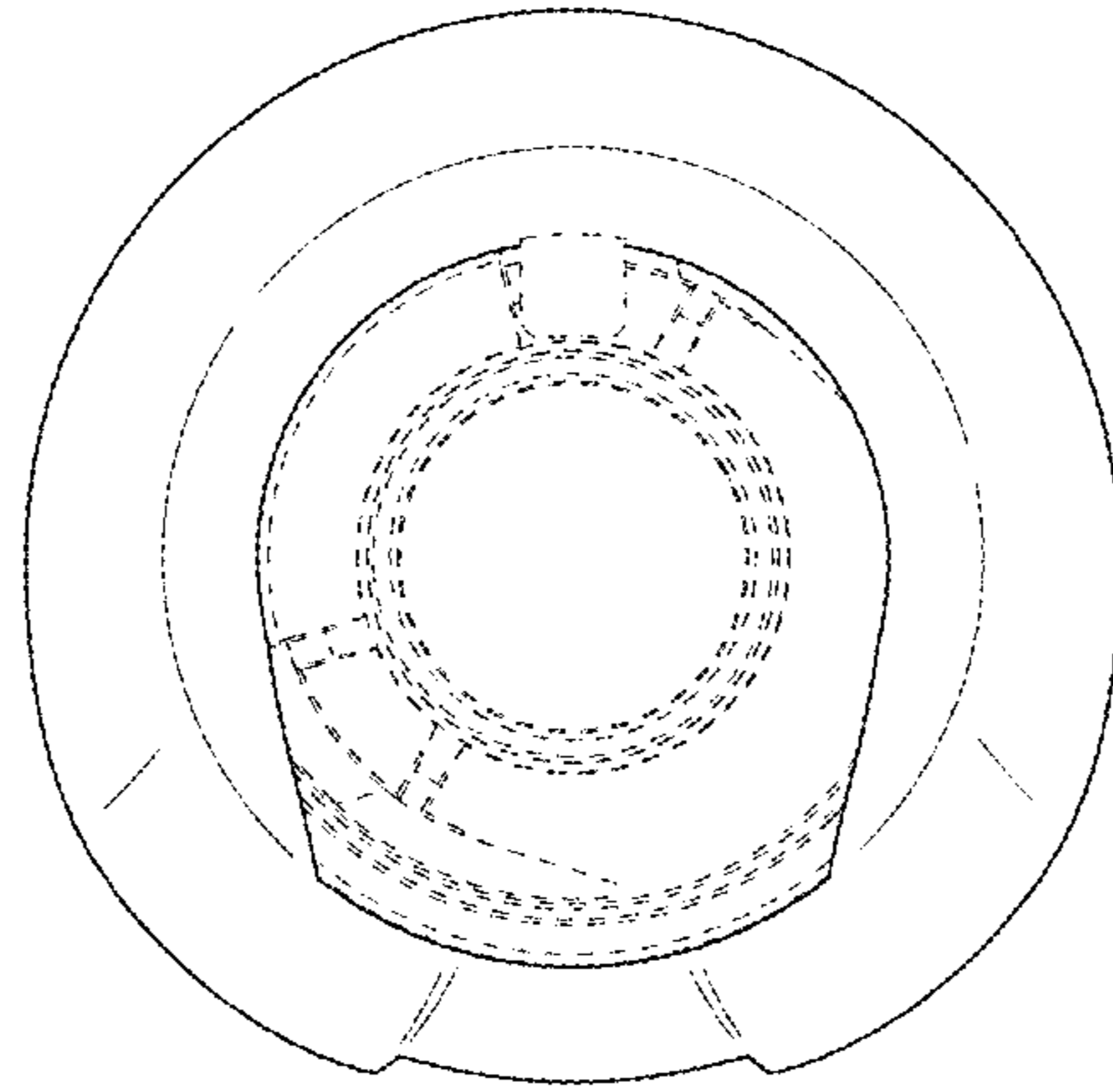

FIG. 7

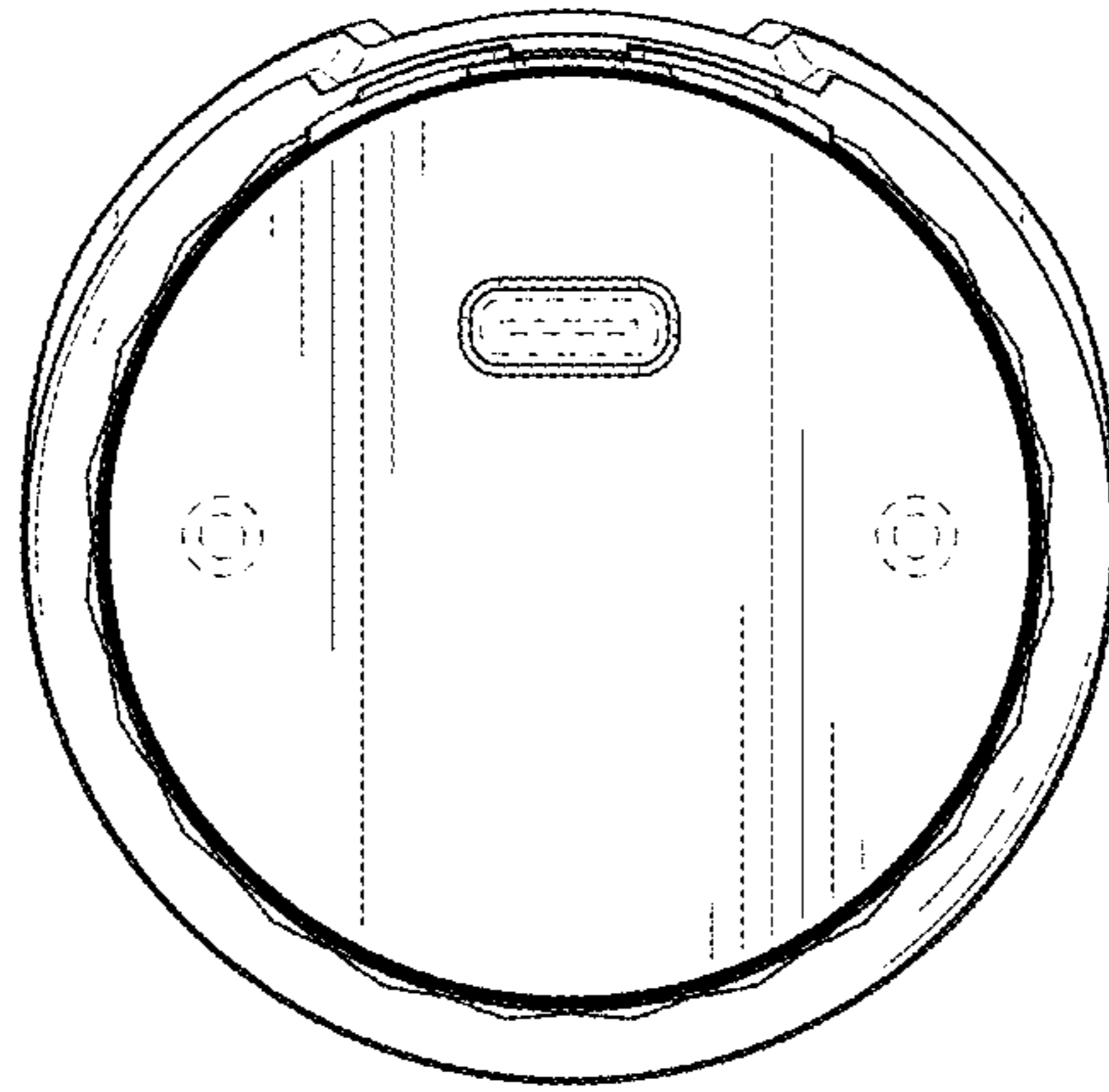

FIG. 8

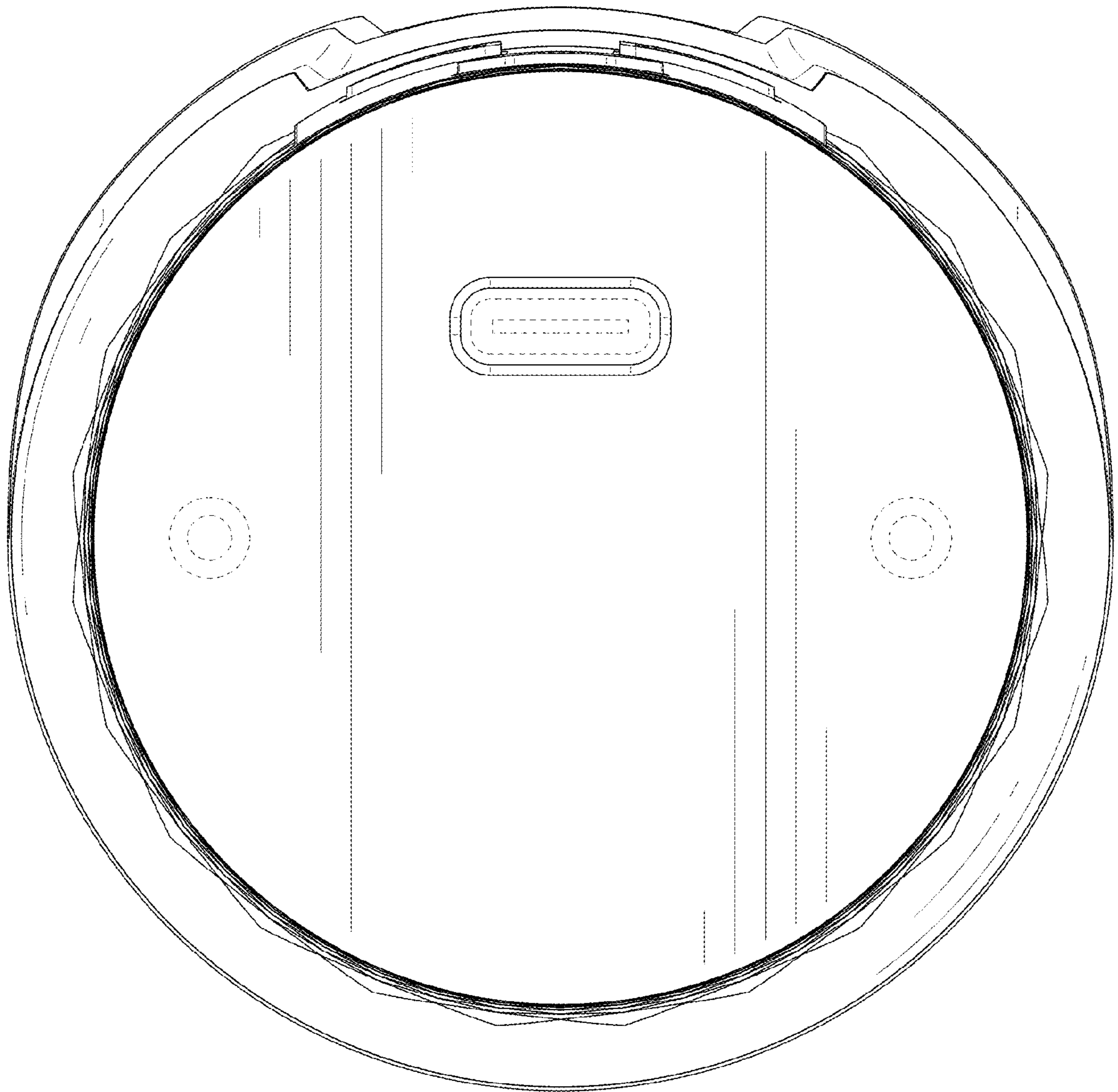

FIG. 9