



US00D934461S

(12) **United States Design Patent** (10) **Patent No.:** **US D934,461 S**
Bauer (45) **Date of Patent:** **** Oct. 26, 2021**

(54) **HEADLIGHT FOR A MOTOR VEHICLE**

(71) Applicant: **Dr. Ing. h.c. F. Porsche**
Aktiengesellschaft, Stuttgart (DE)

(72) Inventor: **Ulrich Bauer, Gerlingen (DE)**

(73) Assignee: **Dr. Ing. h.c. F. Porsche**
Aktiengesellschaft

(**) Term: **15 Years**

(21) Appl. No.: **29/716,792**

(22) Filed: **Dec. 12, 2019**

(30) **Foreign Application Priority Data**

Aug. 22, 2018 (DE) 402019100899.3

(51) **LOC (13) Cl.** **26-06**

(52) **U.S. Cl.**
USPC **D26/28**

(58) **Field of Classification Search**

USPC D26/28-36, 139

CPC F21S 48/00; F21S 48/10; F21S 48/115;

F21S 48/225; F21S 48/1233; F21S

48/1266; F21S 48/1388; F21S 48/2268;

F21V 21/04; F21V 29/004; B60Q 9/13;

B60Q 9/135; B60Q 9/1375

See application file for complete search history.

(56) **References Cited**

U.S. PATENT DOCUMENTS

D506,842 S * 6/2005 Nagura D26/28

D524,466 S * 7/2006 Essig D26/28

D542,442 S * 5/2007 Matsunami D26/28

D552,768 S * 10/2007 Leclercq D26/28

D570,007 S * 5/2008 Hsu D26/28

D863,623 S 10/2019 Bauer

D866,016 S 11/2019 Bauer

D868,304 S 11/2019 Bauer

* cited by examiner

Primary Examiner — Marcus A Jackson

(74) *Attorney, Agent, or Firm* — RatnerPrestia

(57) **CLAIM**

The ornamental design for a headlight for a motor vehicle, as shown and described.

DESCRIPTION

FIG. 1 is an isometric view of a headlight for a motor vehicle;

FIG. 2 is another front isometric view thereof;

FIG. 3 is a front elevation view thereof;

FIG. 4 is an elevation view thereof from the left side;

FIG. 5 is an elevation view thereof from the right side;

FIG. 6 is a top plan view thereof; and,

FIG. 7 is a bottom plan view thereof.

The portions of the headlight for a motor vehicle shown in broken lines are for illustrative and environmental purposes and form no part of the claimed design.

1 Claim, 7 Drawing Sheets

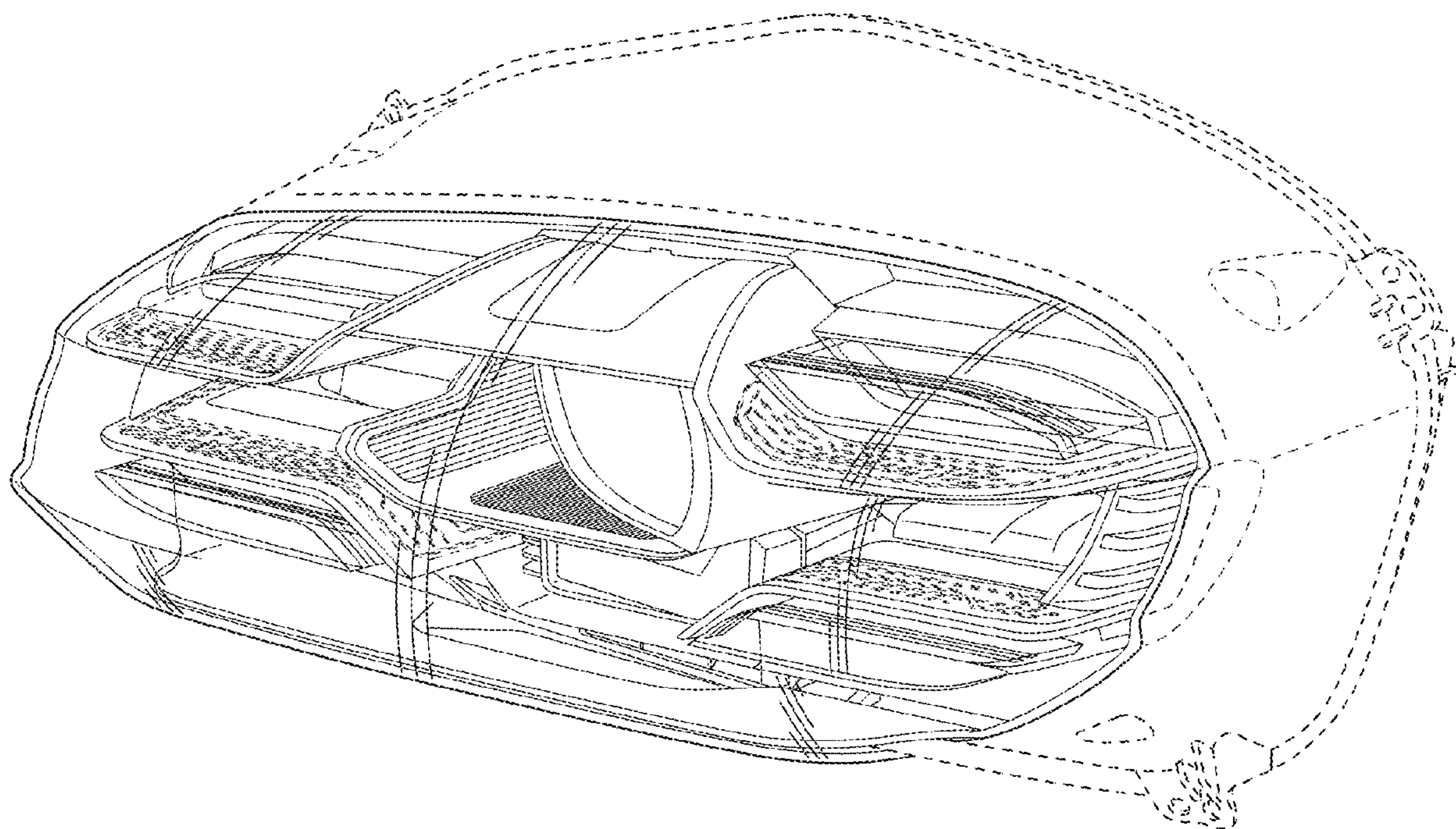

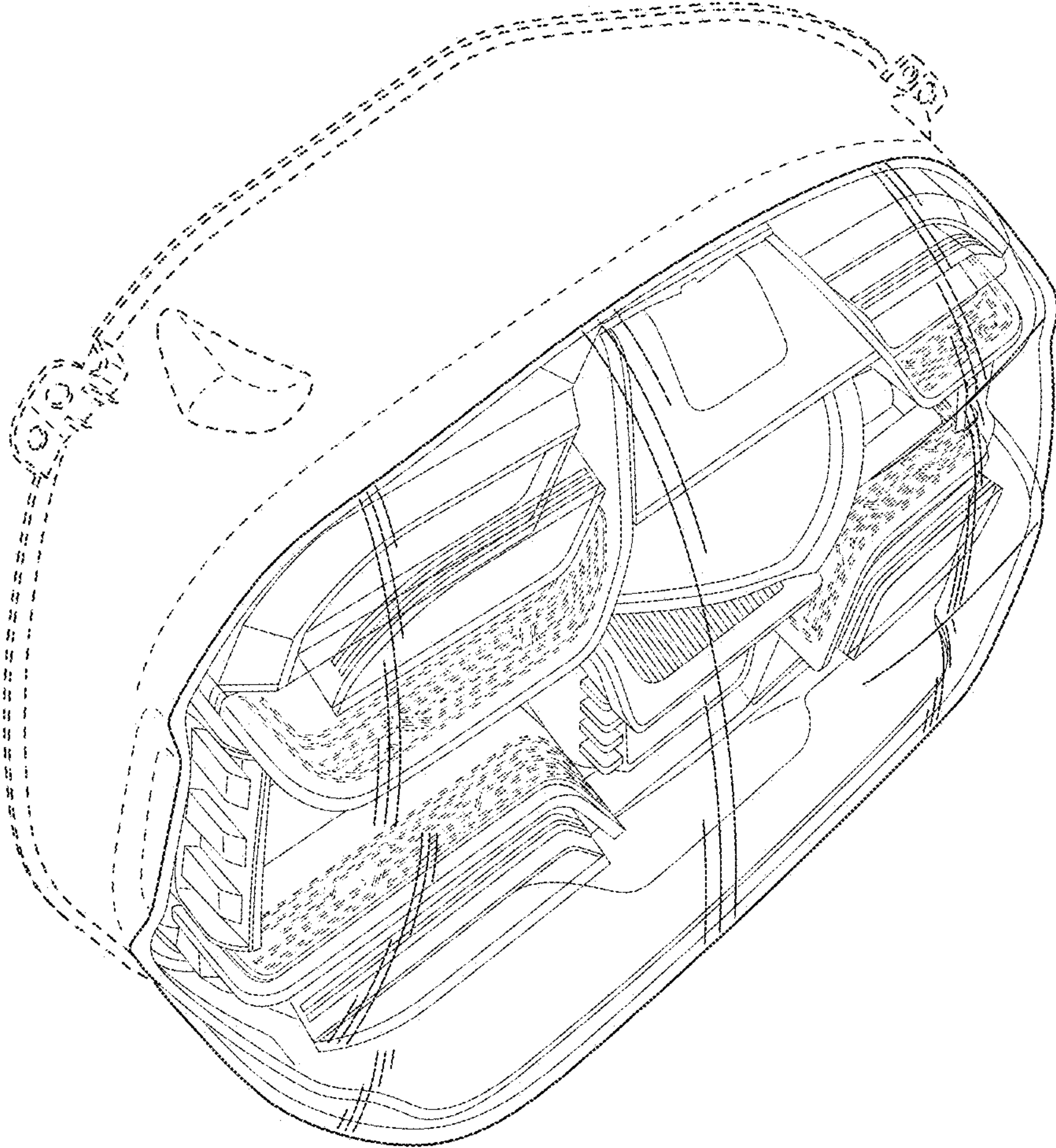

FIG. 1

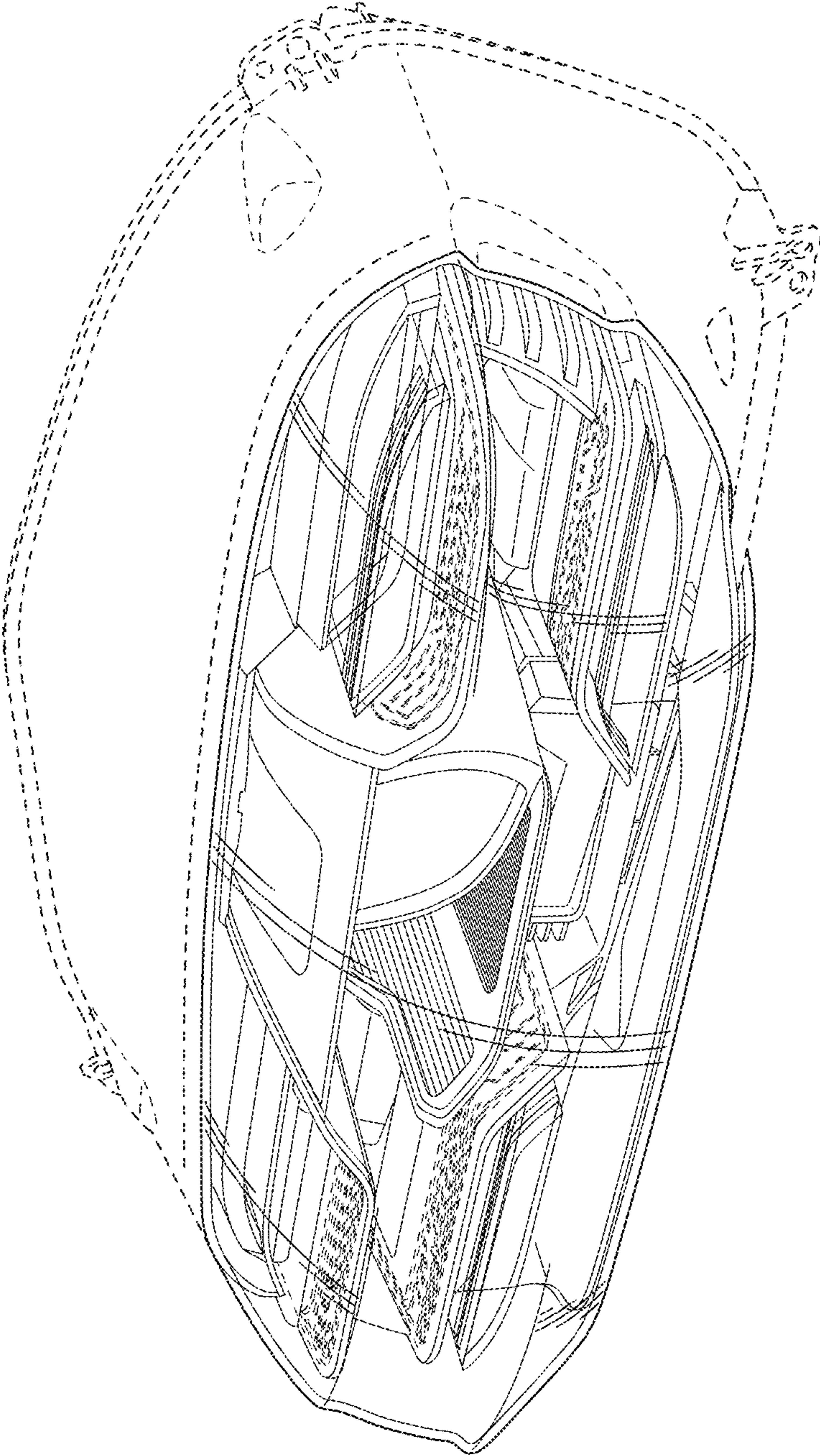

FIG. 2

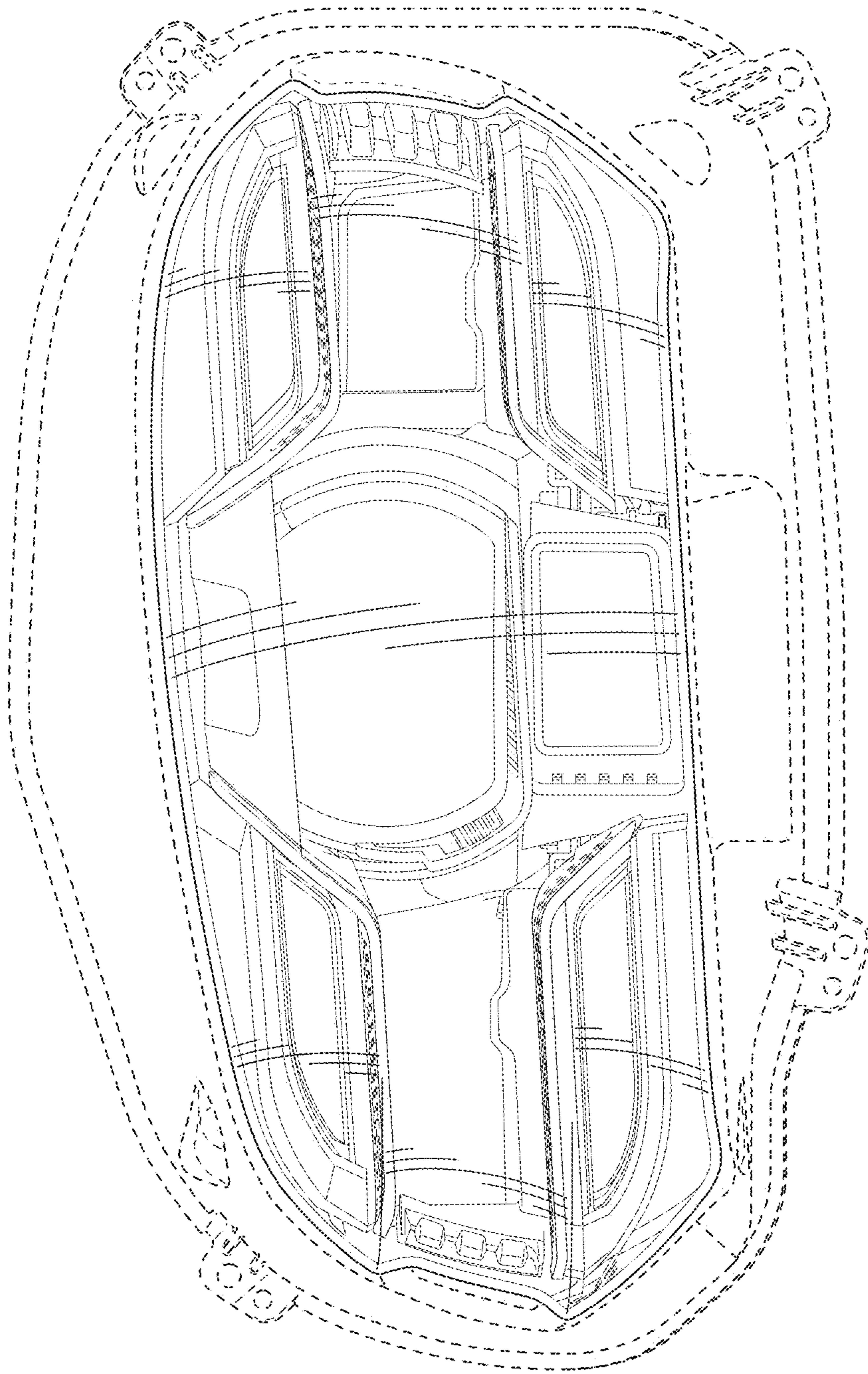

FIG. 3

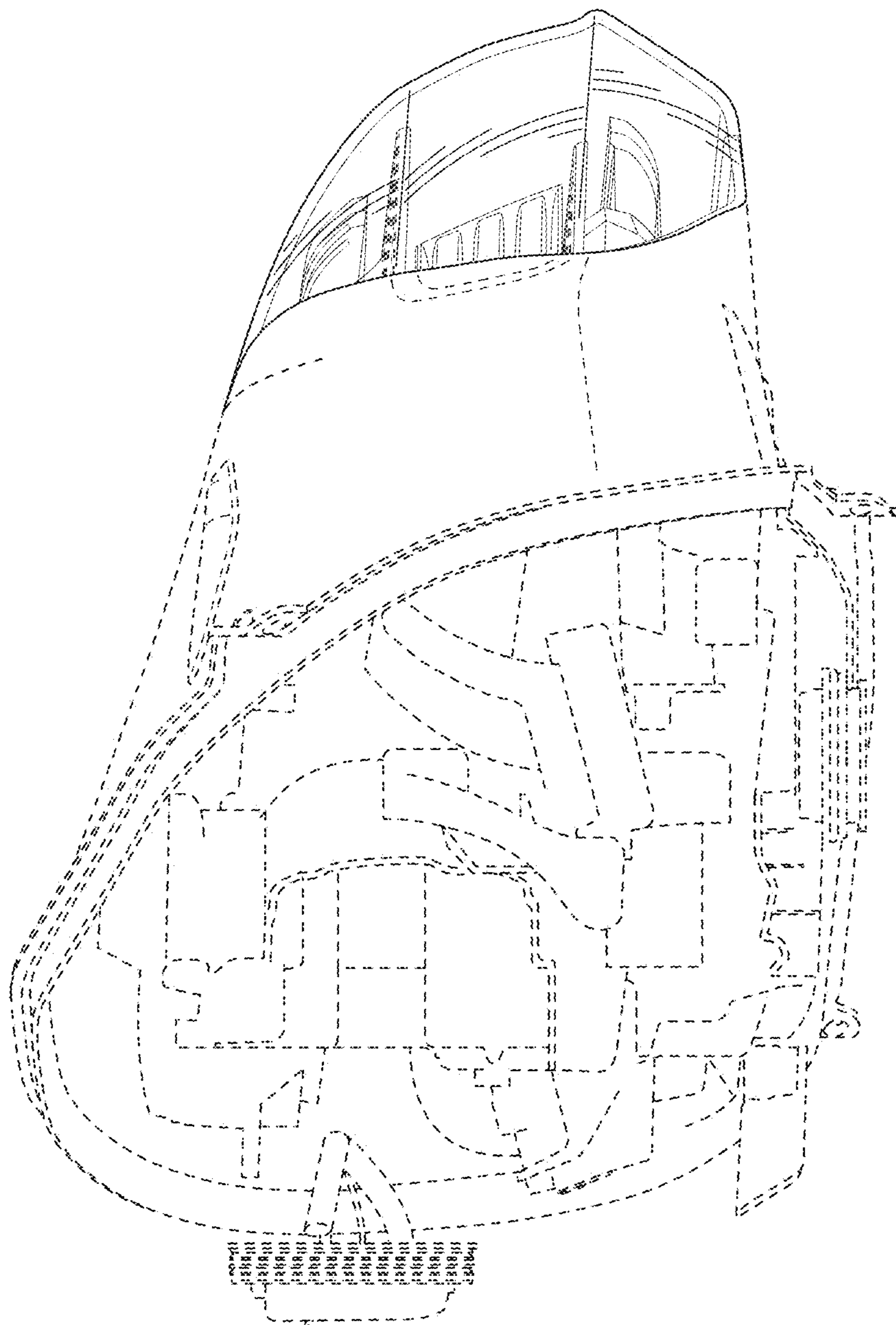

FIG. 4

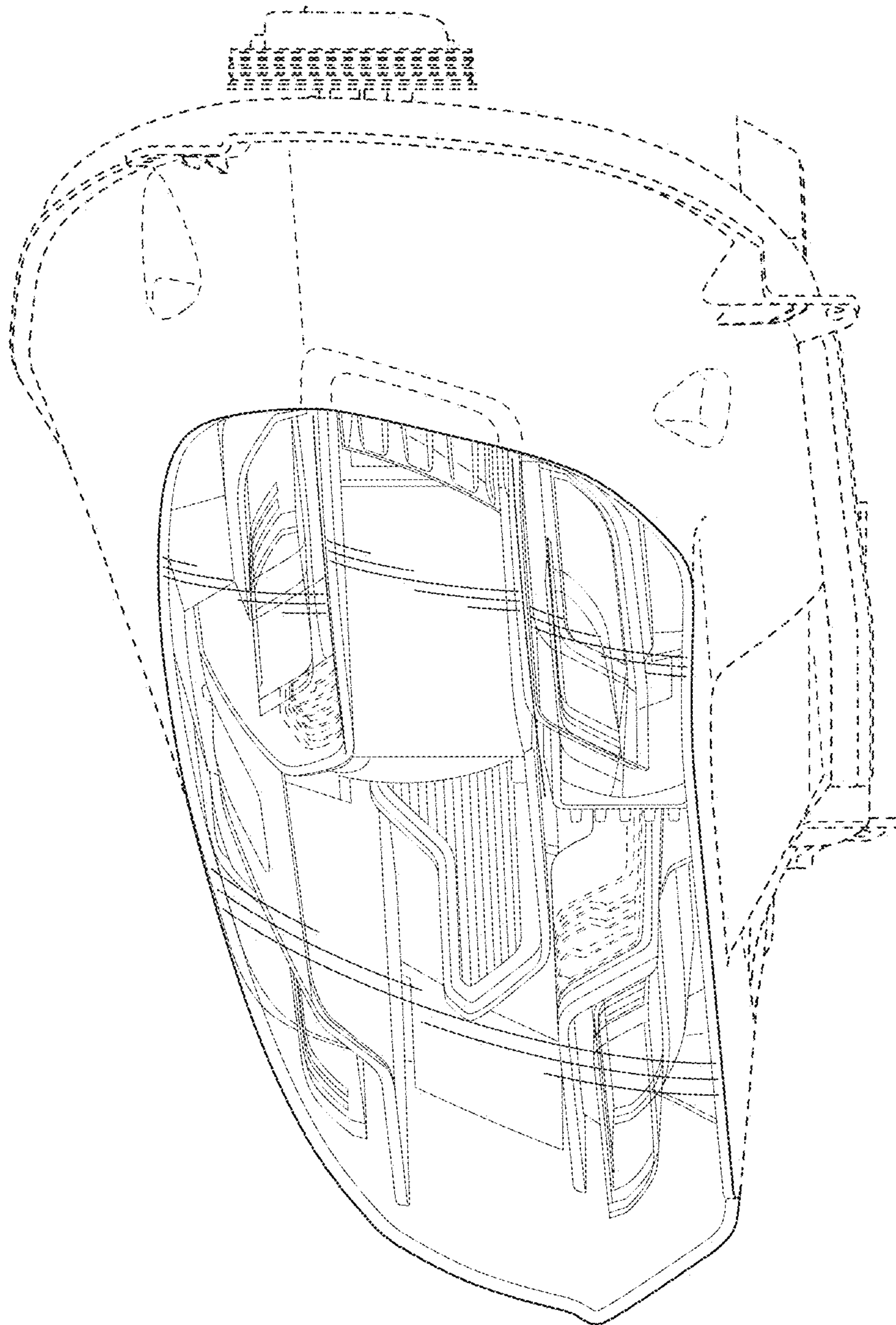

FIG. 5

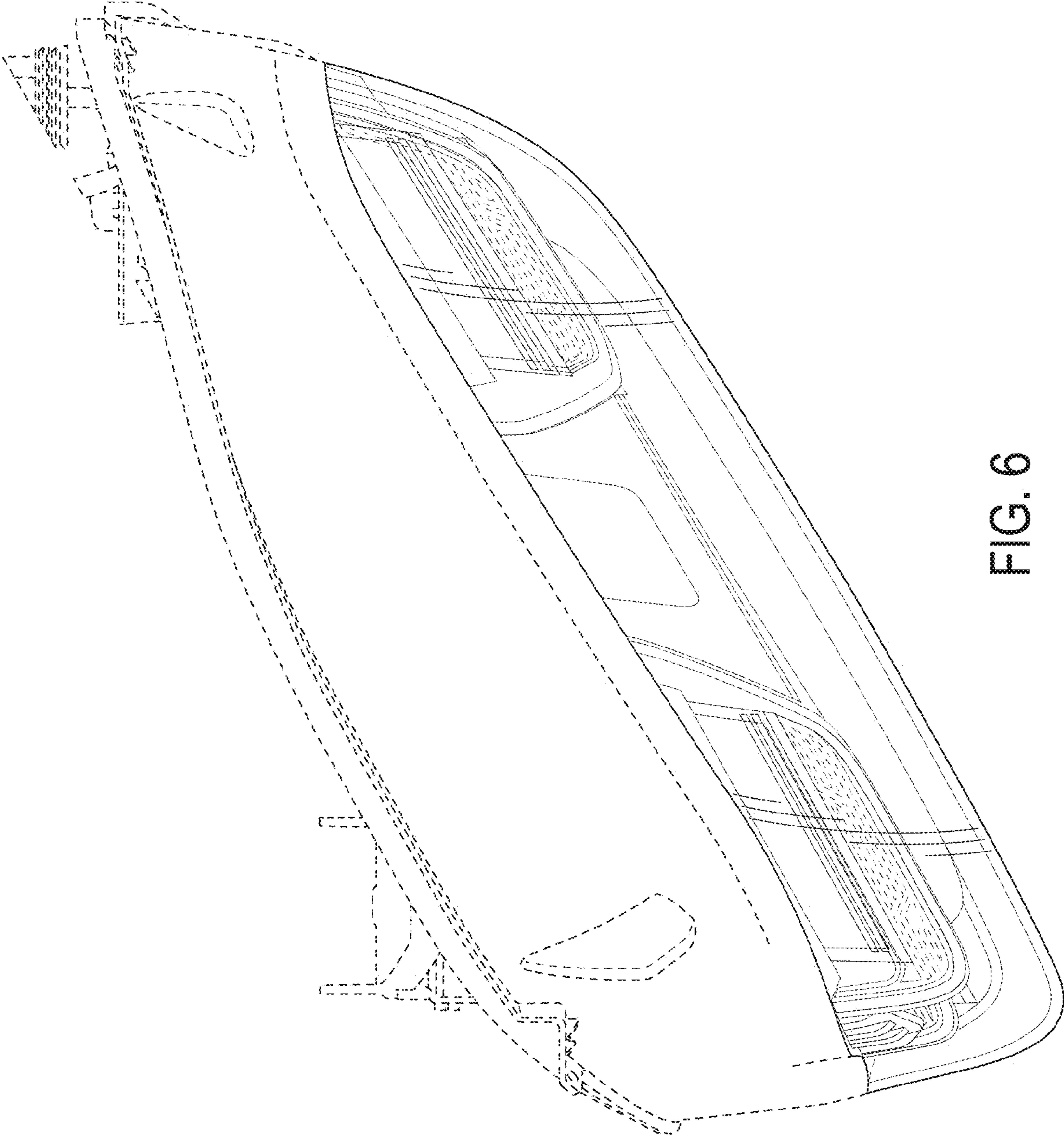

FIG. 6

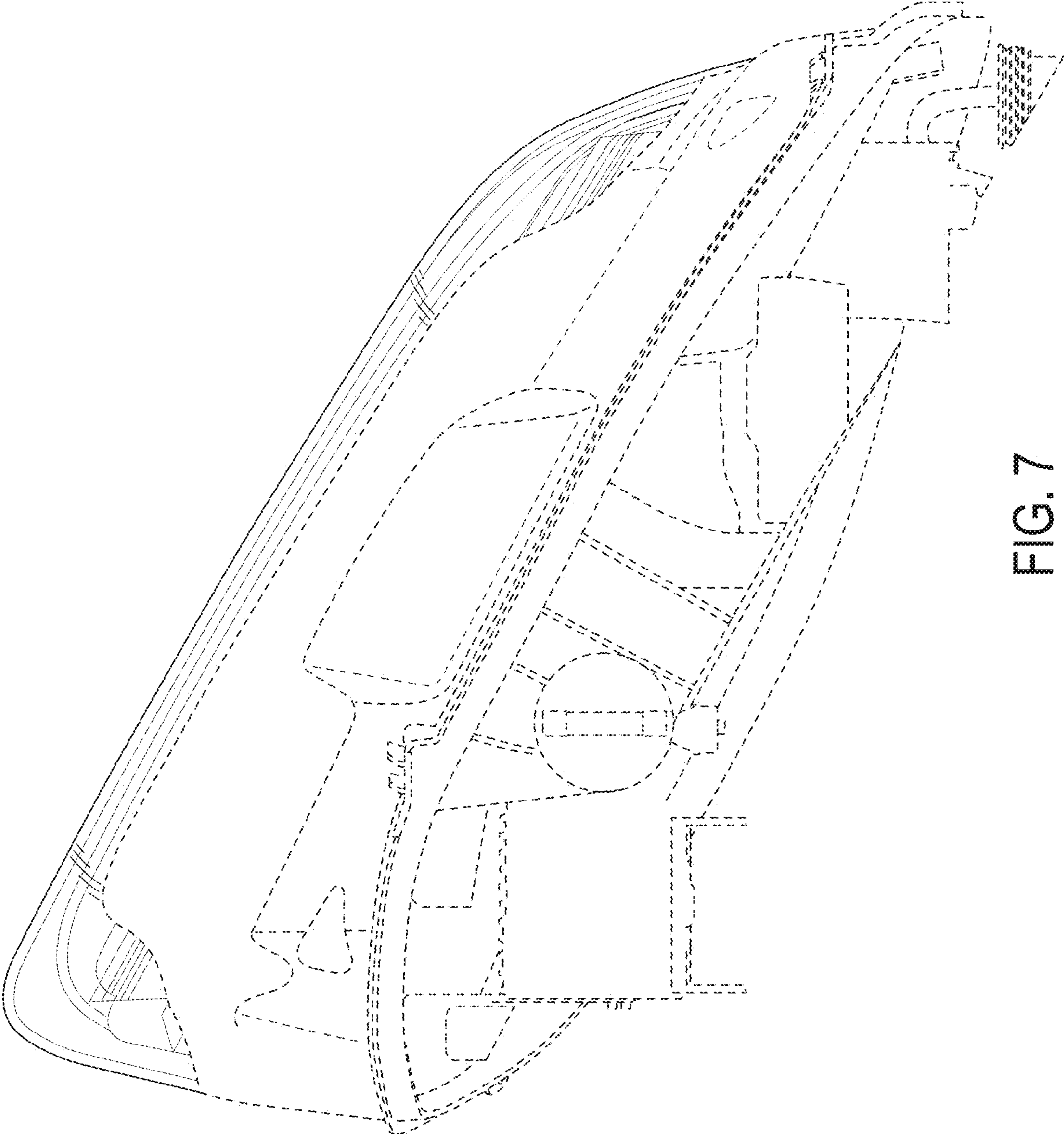

FIG. 7