



US00D934400S

(12) **United States Design Patent** (10) **Patent No.:** **US D934,400 S**
Eilmus et al. (45) **Date of Patent:** **** Oct. 26, 2021**

(54) **SINK**
(71) Applicant: **Kohler Co.**, Kohler, WI (US)
(72) Inventors: **Niels J. Eilmus**, Sheboygan, WI (US);
Christopher J. Santos, Sheboygan Falls, WI (US); **Erika Kovesdi**, Kohler, WI (US)
(73) Assignee: **KOHLER CO.**, Kohler, WI (US)
(**) Term: **15 Years**
(21) Appl. No.: **29/704,492**
(22) Filed: **Sep. 5, 2019**
(51) **LOC (13) Cl.** **23-02**
(52) **U.S. Cl.**
USPC **D23/308**
(58) **Field of Classification Search**
USPC D23/284, 286-287, 290, 292, 293.1, 308
(Continued)

(56) **References Cited**
U.S. PATENT DOCUMENTS
D353,652 S * 12/1994 Dannenberg D23/290
D607,979 S 1/2010 Jiang et al.
(Continued)

Primary Examiner — Robert A Delehanty
(74) *Attorney, Agent, or Firm* — Foley & Lardner LLP

(57) **CLAIM**
We claim the ornamental design for a sink, as shown and described.

DESCRIPTION

FIG. 1 is a perspective view of an embodiment of the claimed design;

FIG. 2 is a front view of the claimed design shown in FIG. 1;
FIG. 3 is a rear view of the claimed design shown in FIG. 1;
FIG. 4 is a side view of the claimed design shown in FIG. 1;
FIG. 5 is another side view of the claimed design shown in FIG. 1;
FIG. 6 is a top view of the claimed design shown in FIG. 1;
FIG. 7 is a bottom view of the claimed design shown in FIG. 1;
FIG. 8 is a perspective view of another embodiment of the claimed design;
FIG. 9 is a front view of the claimed design shown in FIG. 8;
FIG. 10 is a rear view of the claimed design shown in FIG. 8;
FIG. 11 is a side view of the claimed design shown in FIG. 8;
FIG. 12 is another side view of the claimed design shown in FIG. 8;
FIG. 13 is a top view of the claimed design shown in FIG. 8; and,
FIG. 14 is a bottom view of the claimed design shown in FIG. 8.

The ornamental design that is claimed is shown in the drawings as solid lines and surfaces having surface shading. The broken lines in the drawings are for illustrative purposes only and form no part of the claimed design. For example, broken lines formed by equal length dashes show unclaimed portions of the design. Broken lines formed of unequal length dashes (i.e., dash-dot) show boundaries between either claimed and unclaimed portions of the design or between unclaimed and unclaimed portions of the design. Break lines having a jagged element are not part of the claimed design. The appearance of any portion of the article between the break lines forms no part of the claimed design. Cross-hatching provided on cut surfaces is for illustrative purposes only and forms no part of the claimed design.

1 Claim, 8 Drawing Sheets

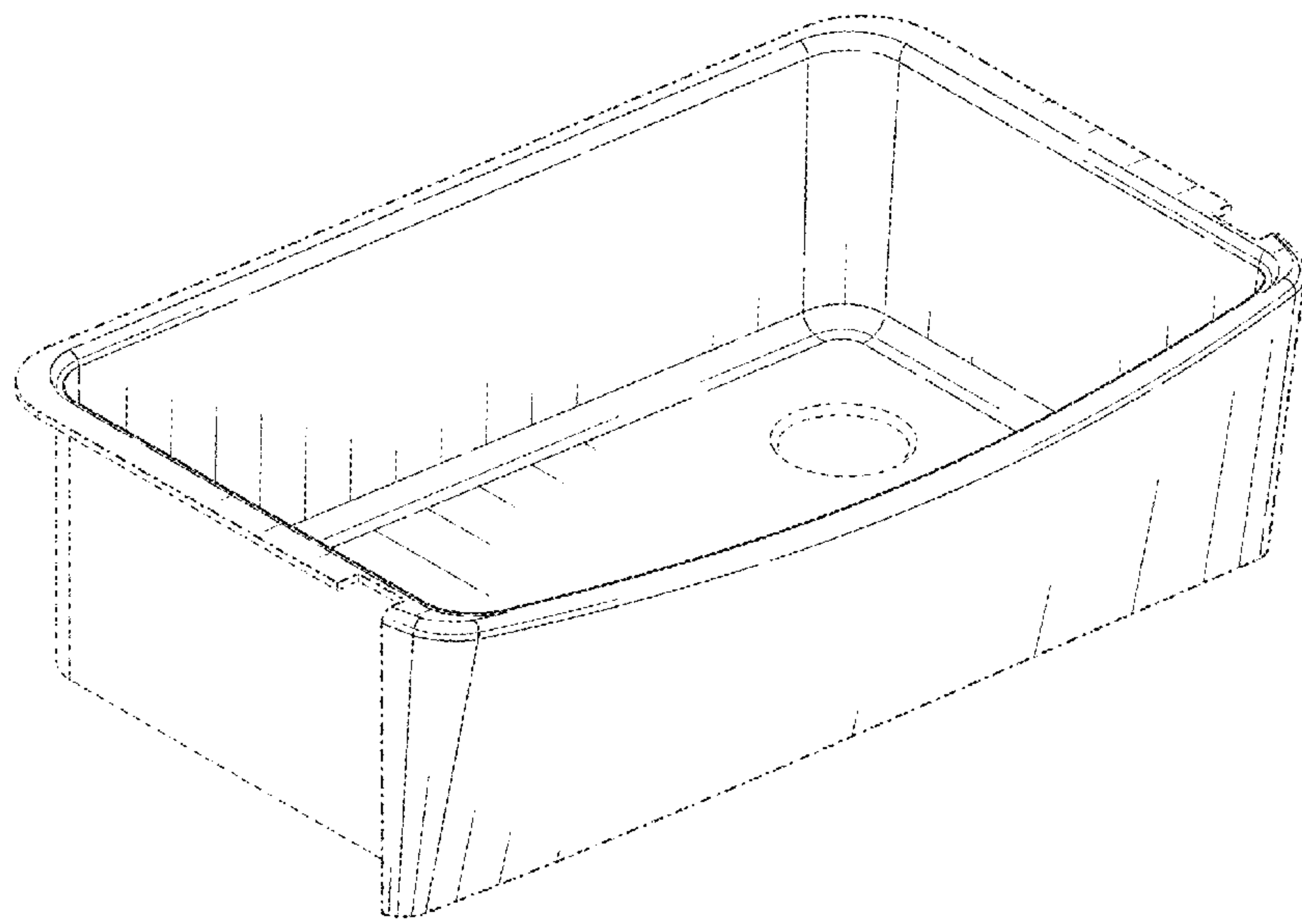

(58) **Field of Classification Search**

CPC A47K 1/04; A47B 77/06

See application file for complete search history.

(56) **References Cited**

U.S. PATENT DOCUMENTS

D651,699 S	1/2012	Booth et al.	
D662,574 S	6/2012	Booth et al.	
D670,366 S	11/2012	Booth et al.	
D692,113 S	10/2013	Eilmus	
D722,145 S	2/2015	Morales et al.	
D725,757 S	3/2015	Morales et al.	
10,130,172 B2	11/2018	Booth et al.	
10,130,173 B2	11/2018	Booth et al.	
10,151,085 B2 *	12/2018	Chong	E03C 1/18
D838,352 S	1/2019	Lilly et al.	
D857,182 S	8/2019	Lilly et al.	
D869,618 S *	12/2019	Walther	D23/284
2021/0112978 A1 *	4/2021	Miller	E03C 1/18

* cited by examiner

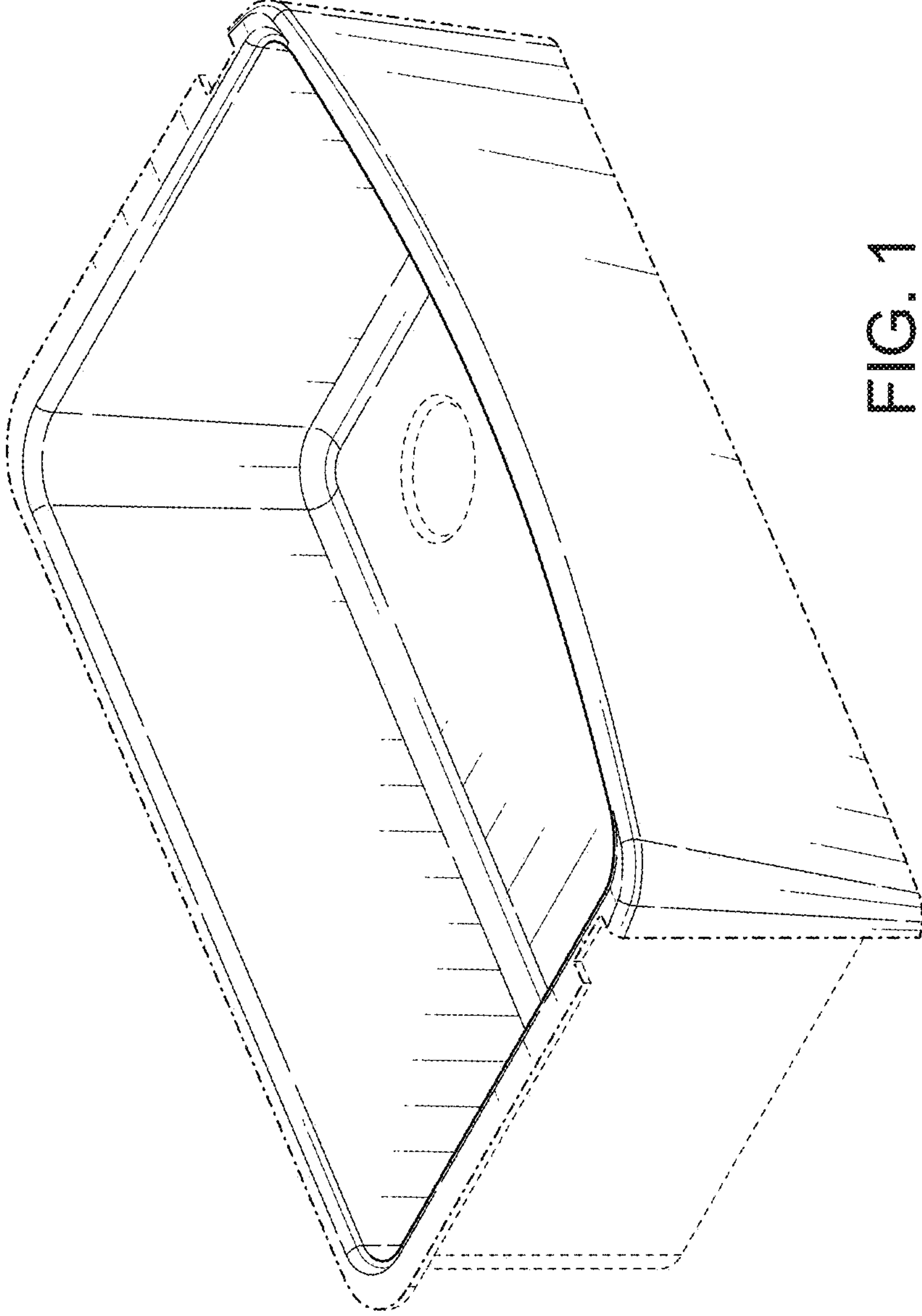

FIG. 1

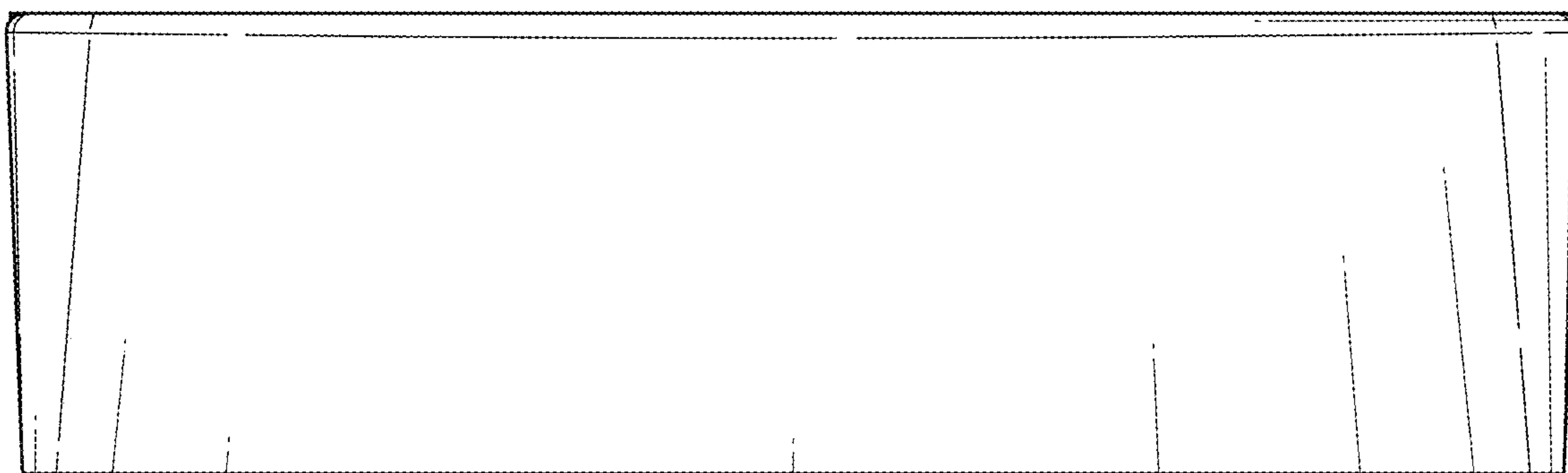

FIG. 2

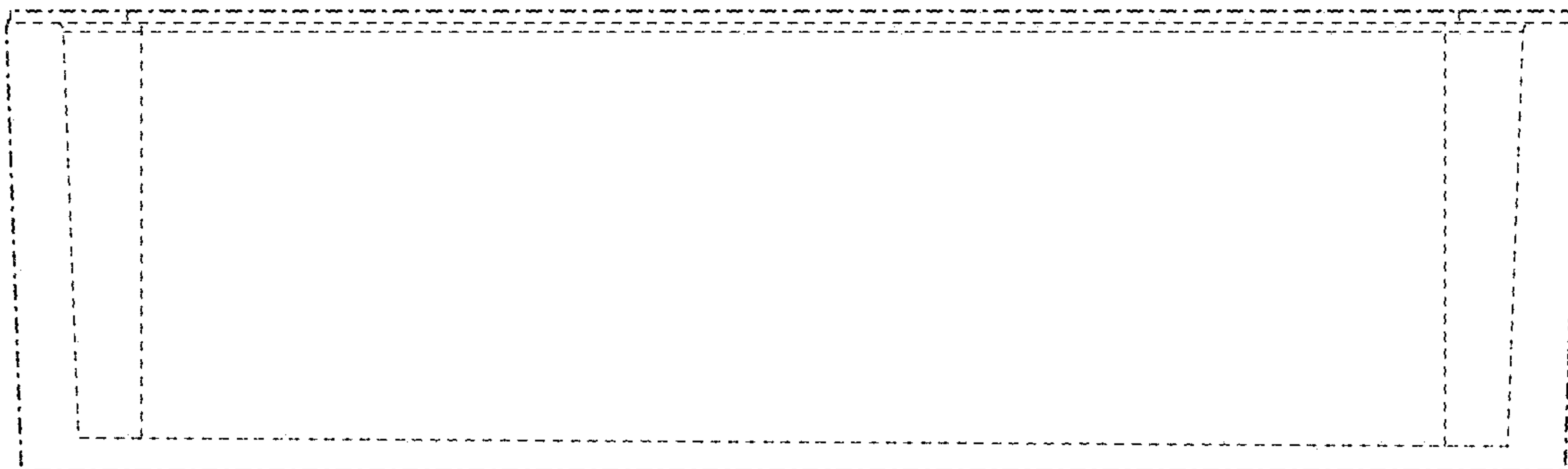

FIG. 3

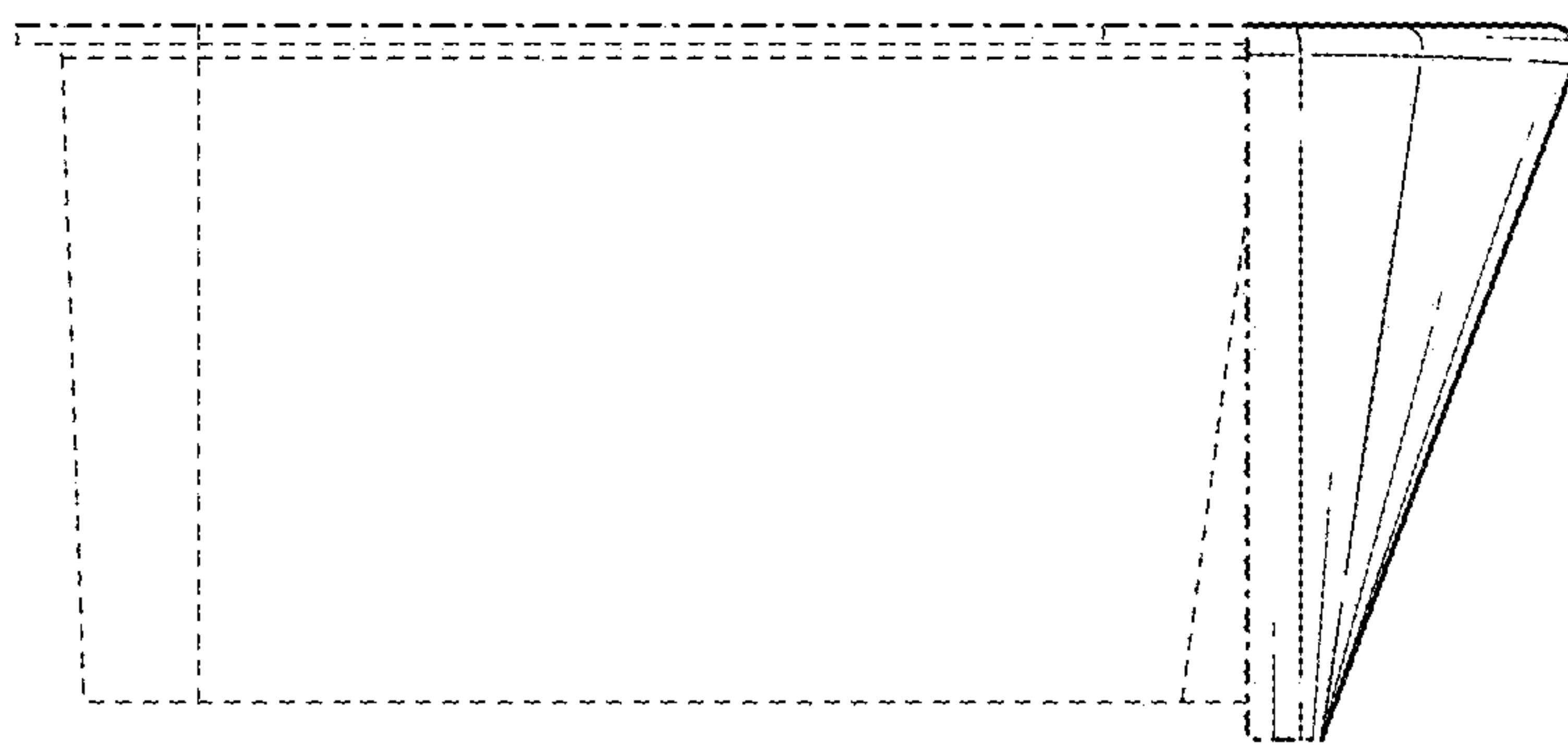

FIG. 4

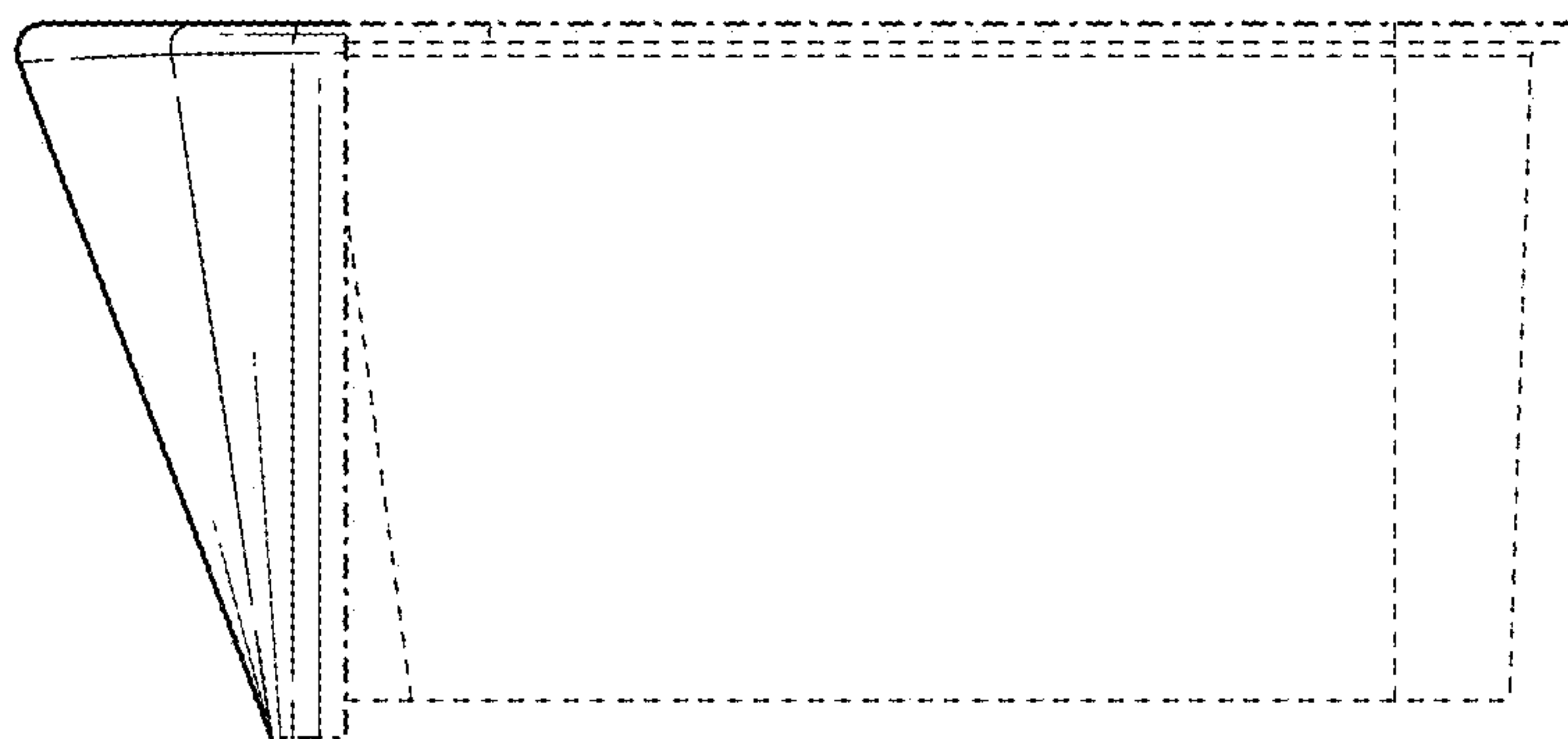

FIG. 5

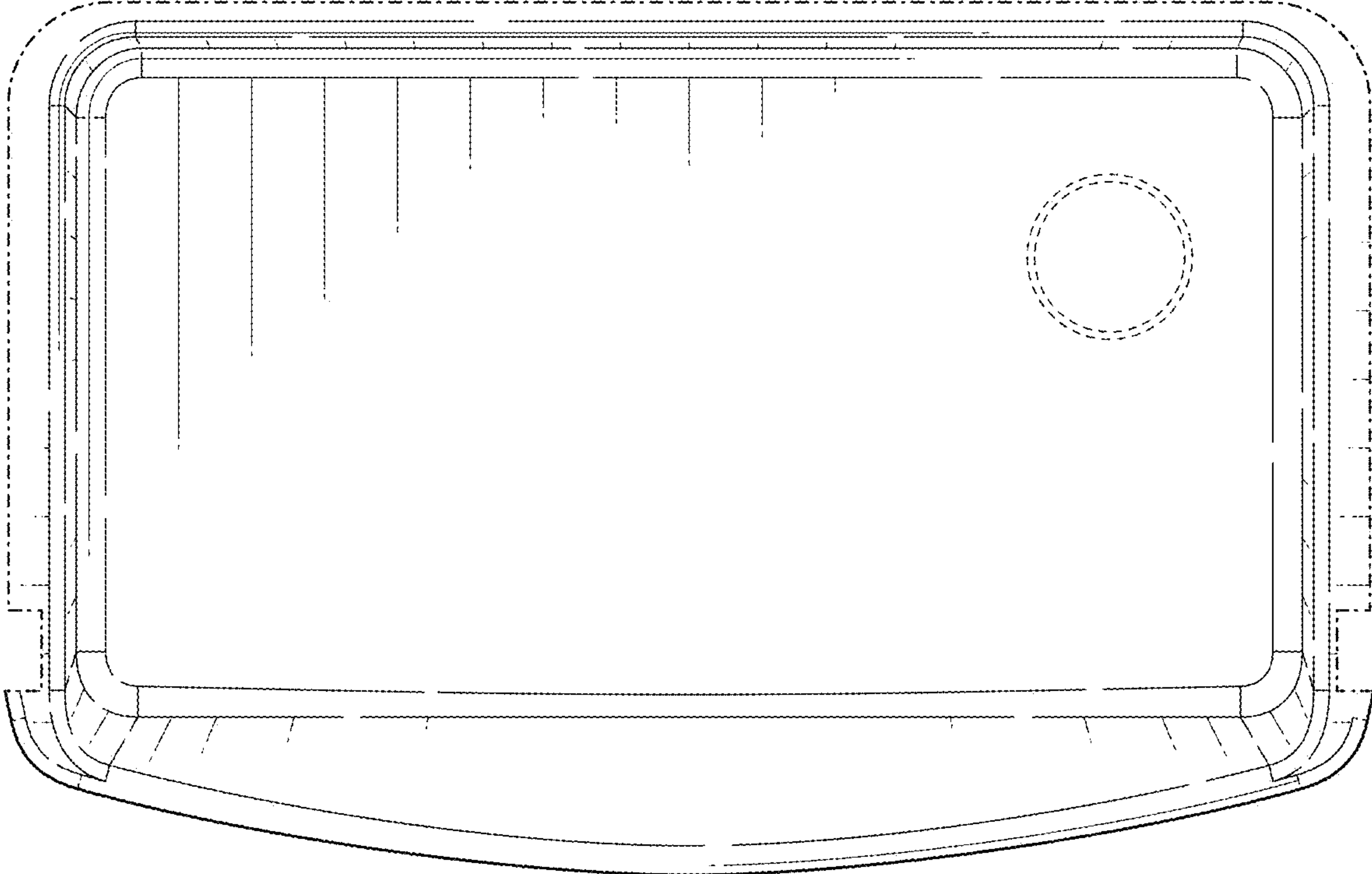

FIG. 6

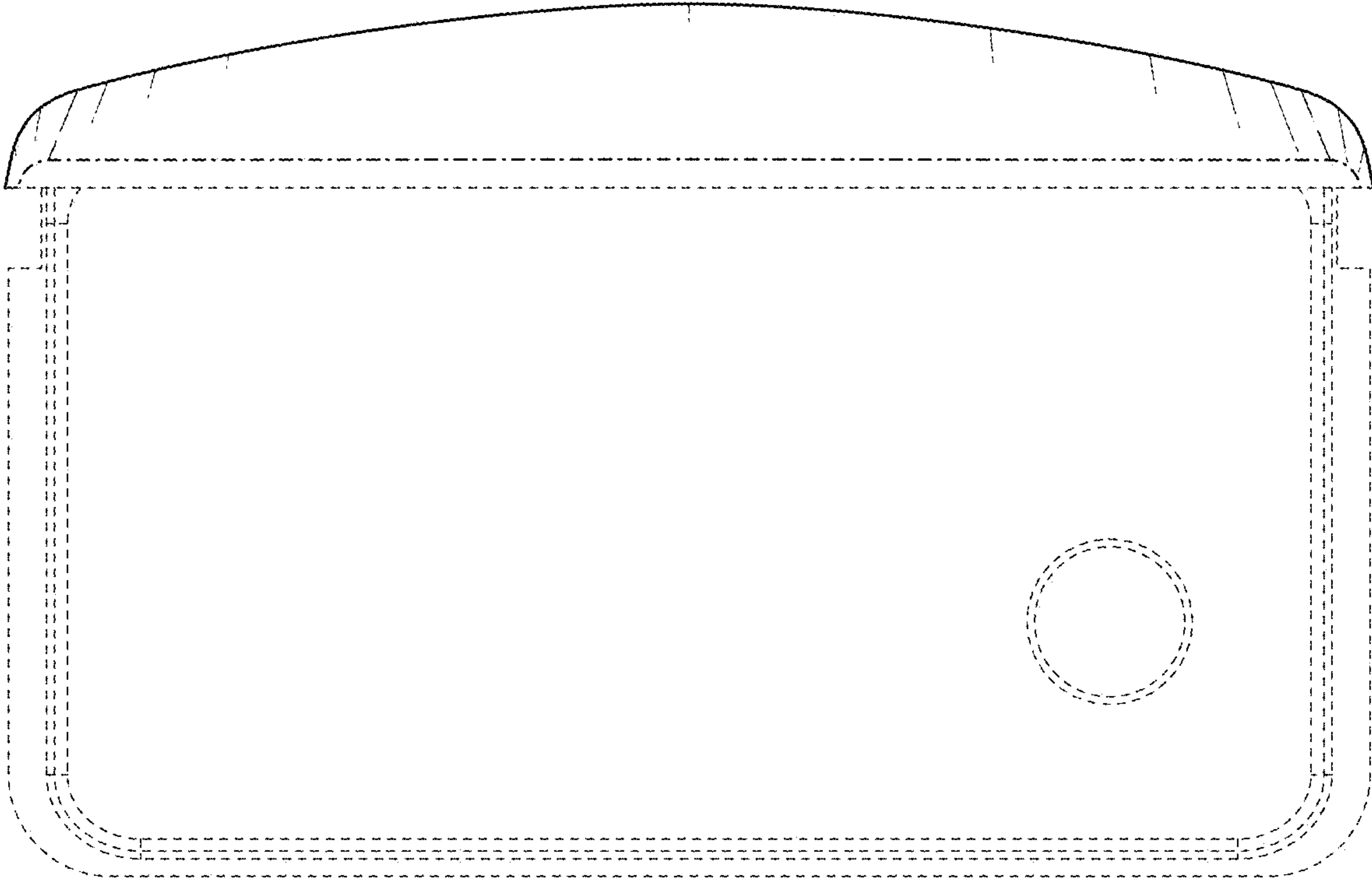

FIG. 7

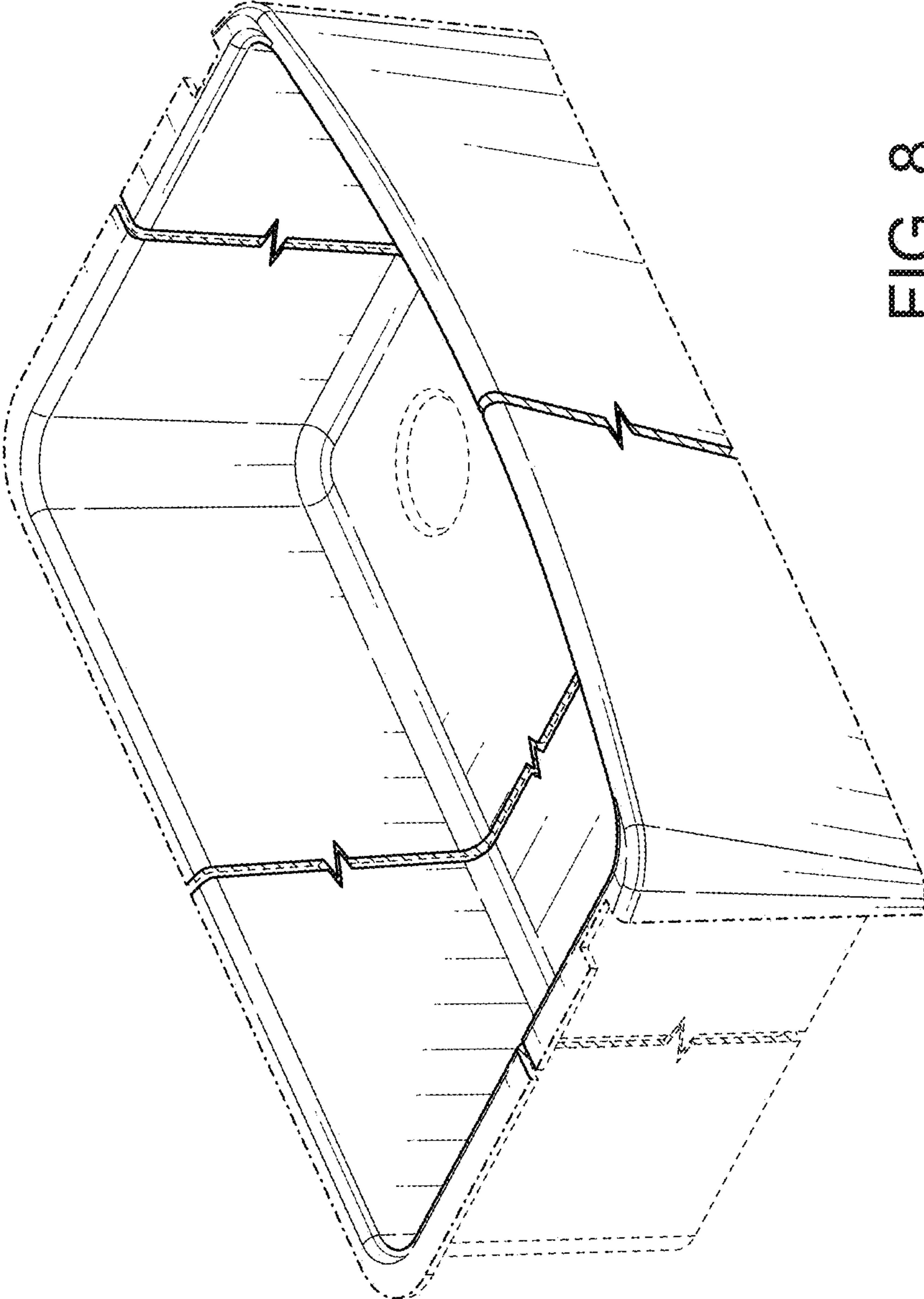

FIG. 8

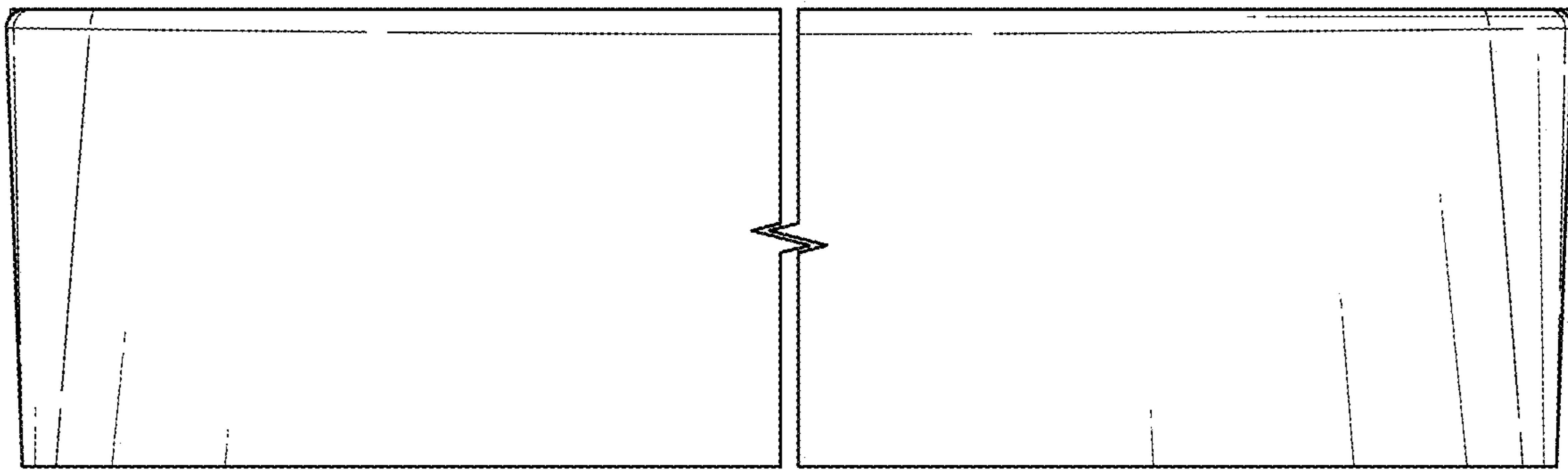

FIG. 9

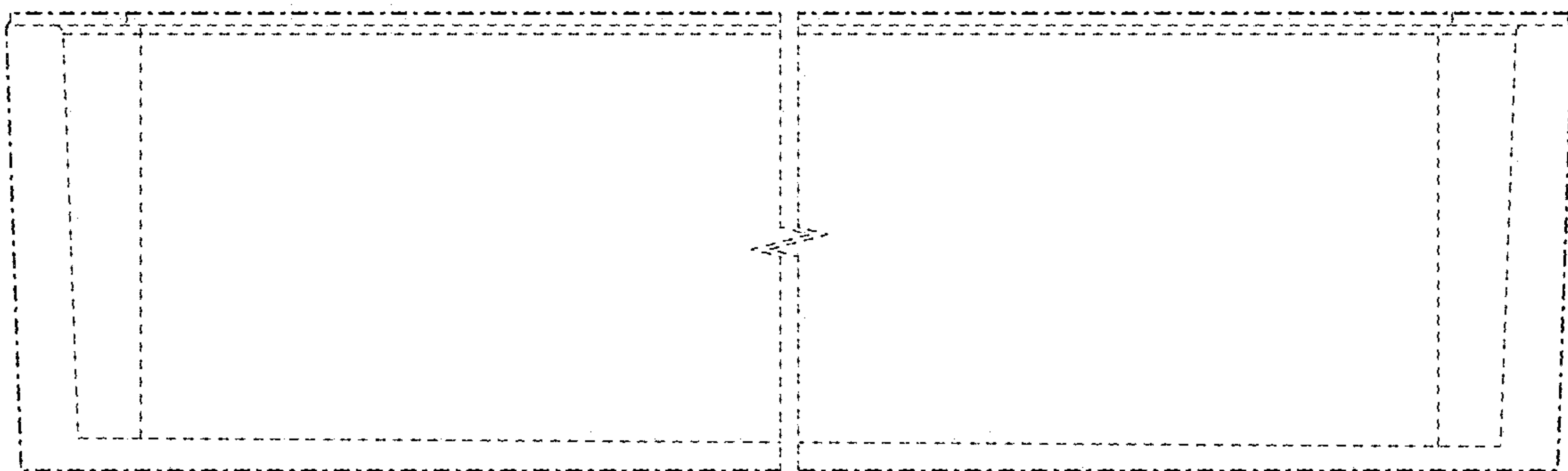

FIG. 10

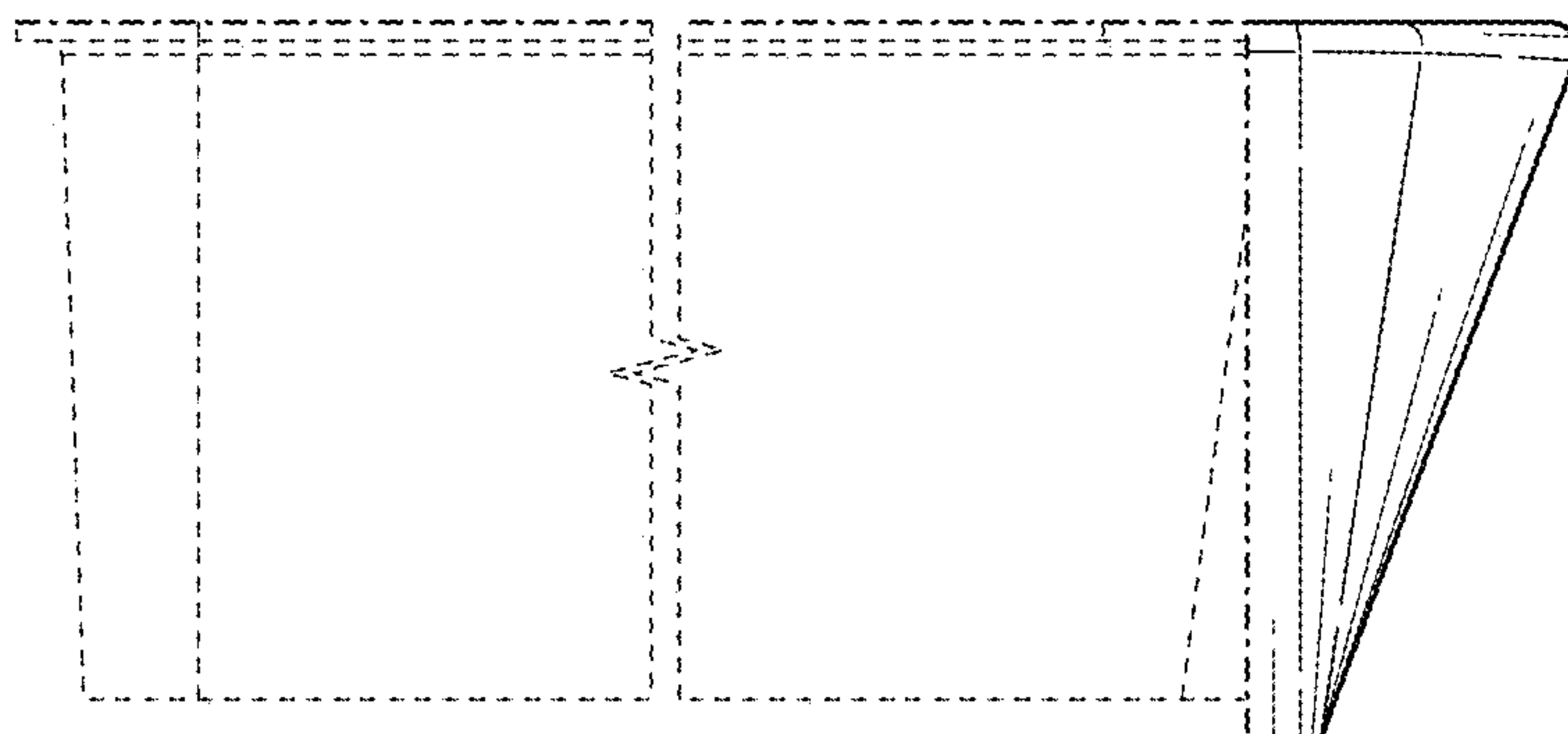

FIG. 11

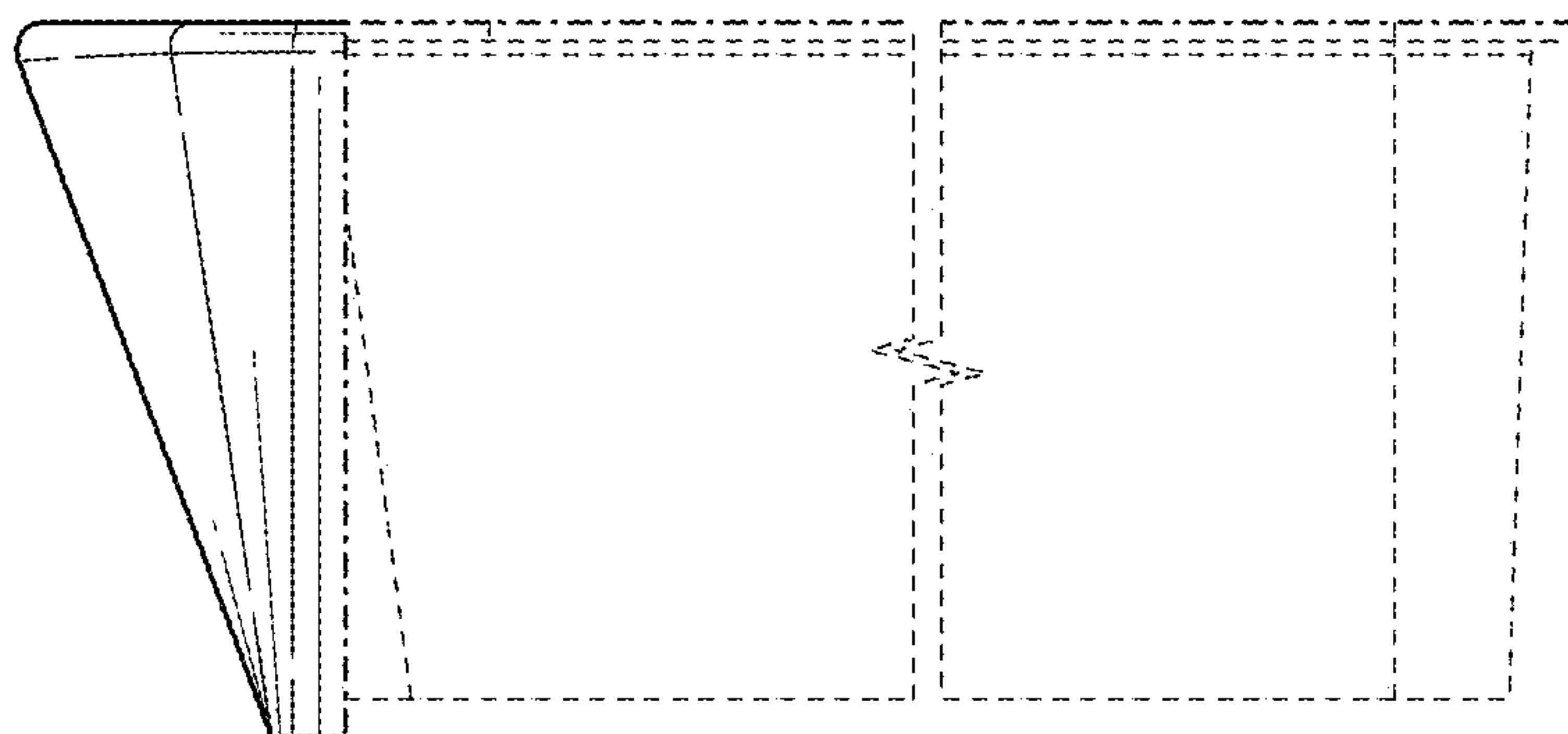

FIG. 12

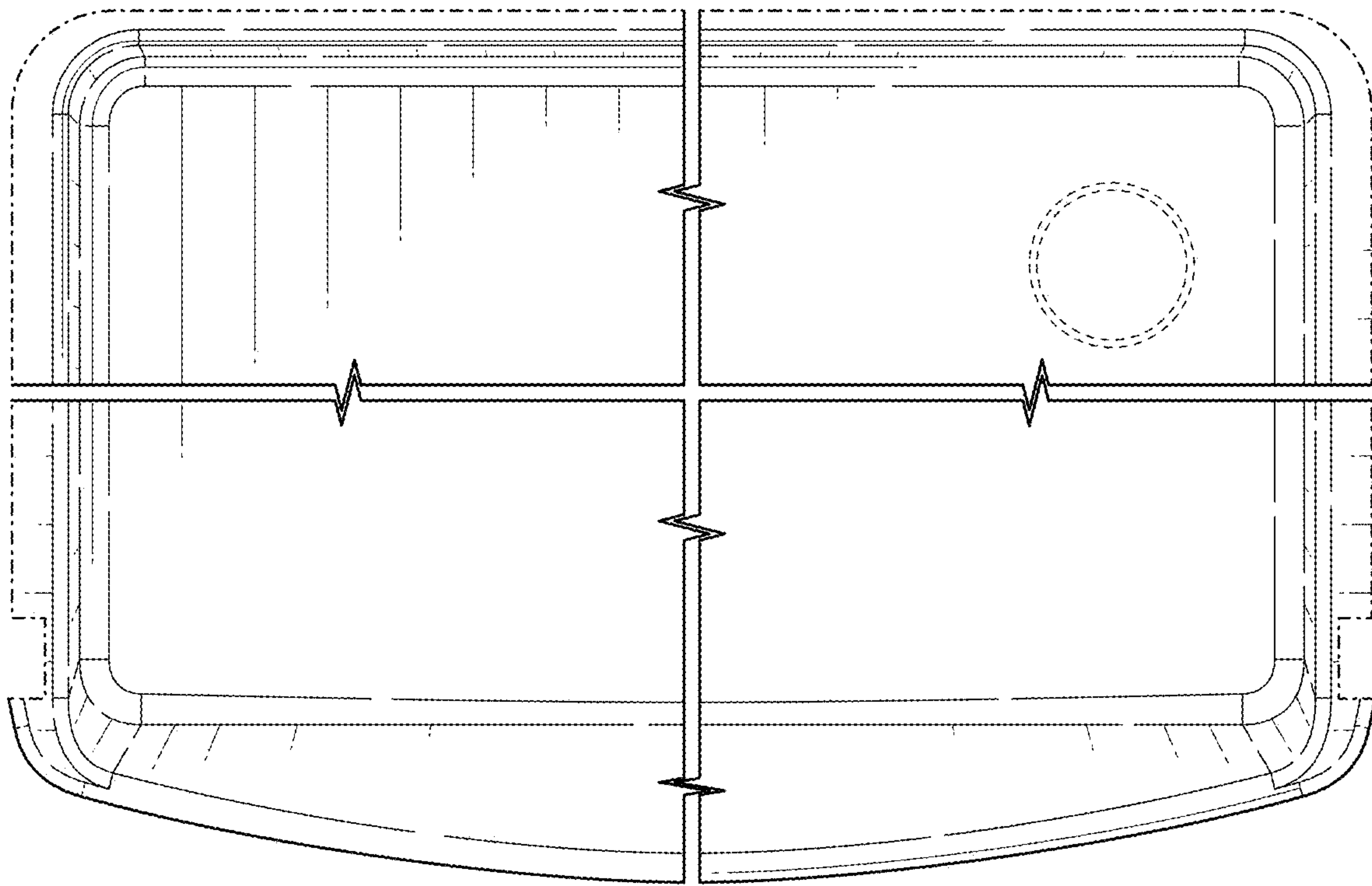

FIG. 13

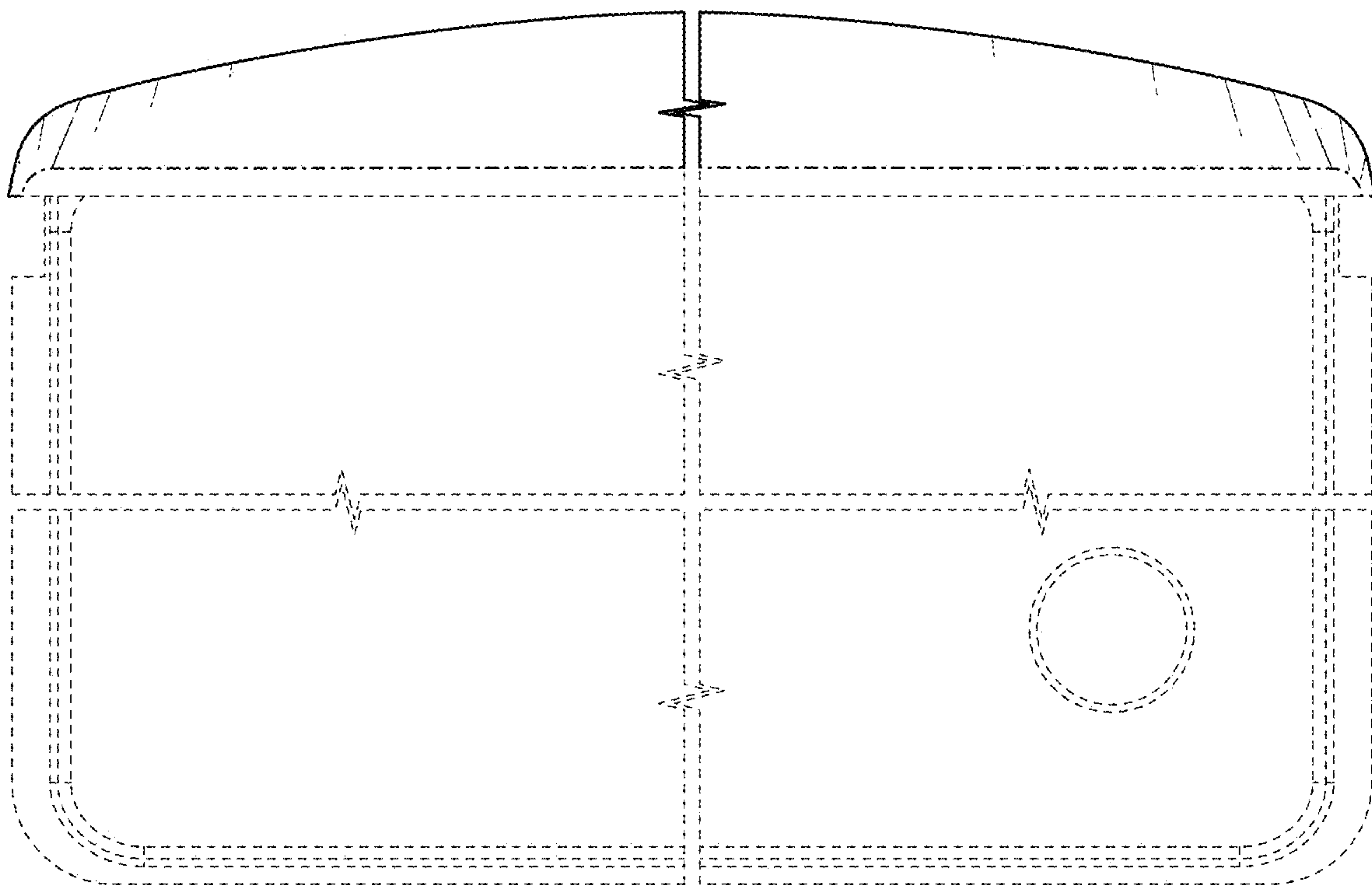

FIG. 14