



US00D934357S

(12) **United States Design Patent**
Corres et al.

(10) **Patent No.:** **US D934,357 S**
(45) **Date of Patent:** **** Oct. 26, 2021**

(54) **YOGA WHEEL**

(74) *Attorney, Agent, or Firm* — Lee & Hayes, P.C.

(71) Applicant: **BarSpout, LLC**, Las Vegas, NV (US)

(57) **CLAIM**

(72) Inventors: **Justin Corres**, Las Vegas, NV (US);
Marvin Lee, Las Vegas, NV (US)

The ornamental design for a yoga wheel, as shown and described.

(73) Assignee: **BARSPOUT, LLC**, Las Vegas, NV (US)

DESCRIPTION

(**) Term: **15 Years**

FIG. 1 is a perspective view of a first embodiment of a yoga wheel, taken from the front.

(21) Appl. No.: **29/716,453**

FIG. 2 is a front view of the first embodiment of the yoga wheel of FIG. 1;

(22) Filed: **Dec. 10, 2019**

FIG. 3 is a back view of the first embodiment of the yoga wheel of FIG. 1;

(51) **LOC (13) Cl.** **21-02**

(52) **U.S. Cl.**
USPC **D21/686**

FIG. 4 is a left-side view of the first embodiment of the yoga wheel of FIG. 1.

(58) **Field of Classification Search**
USPC D21/686, 691, 662, 713, 687, 797, 688,
D21/484, 671; D24/190, 191, 192, 183,
D24/186

FIG. 5 is a right-side view of the first embodiment of the yoga wheel of FIG. 1.

(Continued)

FIG. 6 is a top view of the first embodiment of the yoga wheel of FIG. 1.

(56) **References Cited**

FIG. 7 is a bottom view of the first embodiment of the yoga wheel of FIG. 1.

U.S. PATENT DOCUMENTS

FIG. 8 is a top perspective view of a second embodiment of yoga wheel, take from the side;

2,270,553 A * 1/1942 Potito A63B 41/08
473/596
5,125,361 A * 6/1992 Rowlands A01K 15/027
119/700

FIG. 9 is a front view of the second embodiment of the yoga wheel of FIG. 8;

(Continued)

FIG. 10 is a back view of the second embodiment of the yoga wheel of FIG. 8;

OTHER PUBLICATIONS

Risefit yoga wheel, announced 2016 [online], [site visited Jul. 8, 2021]. Available on internet, URL:<https://www.amazon.com/Yoga-Wheel-Comfortable-Stretching-Flexibility/dp/B01DB9JNLI?th=1> (Year: 2016).*

FIG. 11 is a left-side view of the second embodiment of the yoga wheel of FIG. 8;

(Continued)

FIG. 12 is a right-side view of the second embodiment of the yoga wheel of FIG. 8;

Primary Examiner — Khawaja Anwar
Assistant Examiner — Julice Seung Eun Oum

FIG. 13 is a top view of the second embodiment of the yoga wheel of FIG. 8;

FIG. 14 is a bottom view of the second embodiment of the yoga wheel of FIG. 8; and,

FIG. 15 is an exploded view of the pattern on the exterior surface of the second embodiment of the yoga wheel of FIG. 8.

The dashed broken lines depict portions of the yoga wheel which form no part of the claimed design. The dot-dashed

(Continued)

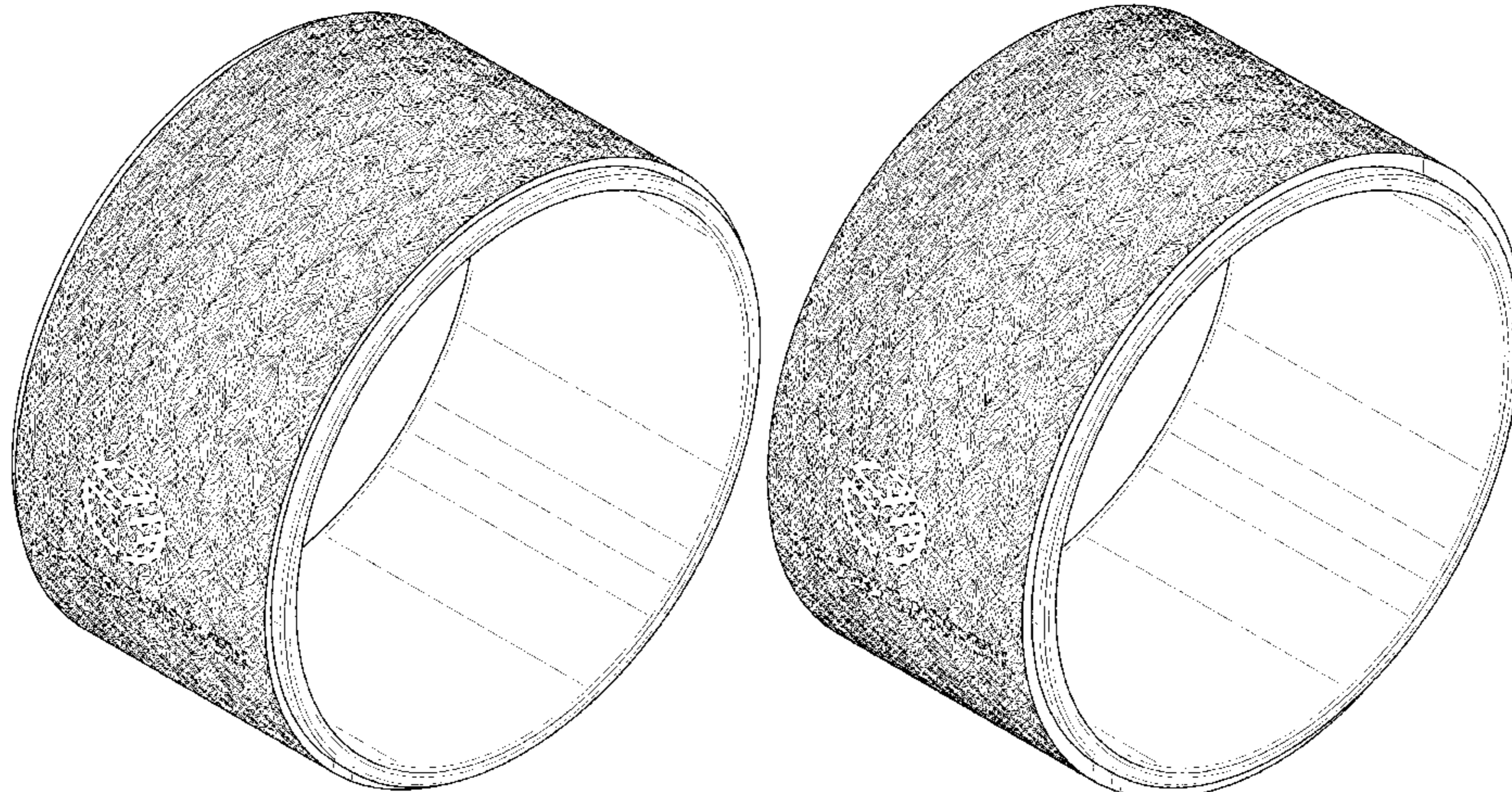

broken lines represent boundaries of the claimed yoga wheel and form no part of the claimed design.

1 Claim, 15 Drawing Sheets

(58) Field of Classification Search

CPC A01K 15/02; F21V 33/00
See application file for complete search history.

(56) References Cited

U.S. PATENT DOCUMENTS

D657,011 S * 4/2012 Lederman D21/707
9,694,226 B1 * 7/2017 Vargas A63B 21/4039
D819,149 S * 5/2018 Zhang D21/691
D904,626 S * 12/2020 Wilgus-Hansen D24/190
2019/0191667 A1 * 6/2019 Harada A01K 15/027
2020/0275636 A1 * 9/2020 Kim A01K 15/027

OTHER PUBLICATIONS

Petes choice yoga wheel, announced 2019 [online], [site visited Jul. 8, 2021]. Available on internet, URL:https://www.amazon.com/Yoga-Wheel-Pack-Improve-Posture/dp/B08LLBB1HR/ref=sr_1_73_sspa?dchild=1&keywords=yoga%2Bwheel&qid=1623894955&s=sporting-goods&sr=1-73-spons&spLa=ZW5jenlwdGVkUXVhbGlmaWVyPUEzSkFZWUZMNzFLMzBVJmVuY3J5cHRIZEIkPUEwNTczNTI1R0pXTEICT1pJMk85JmVuY3J5cHRIZEFkSWQ9QTA3ODM0NTgzTUdFRU9GUThaVEQ5JndpZGdldE5hbWU9c3BfYXRmX25leHQmYWN0aW9uPWNsaWNrUmVkaXJlY3QmZG9Ob3Rmb2dDbGljaz10cnVI&th=1 (Year: 2019).*

* cited by examiner

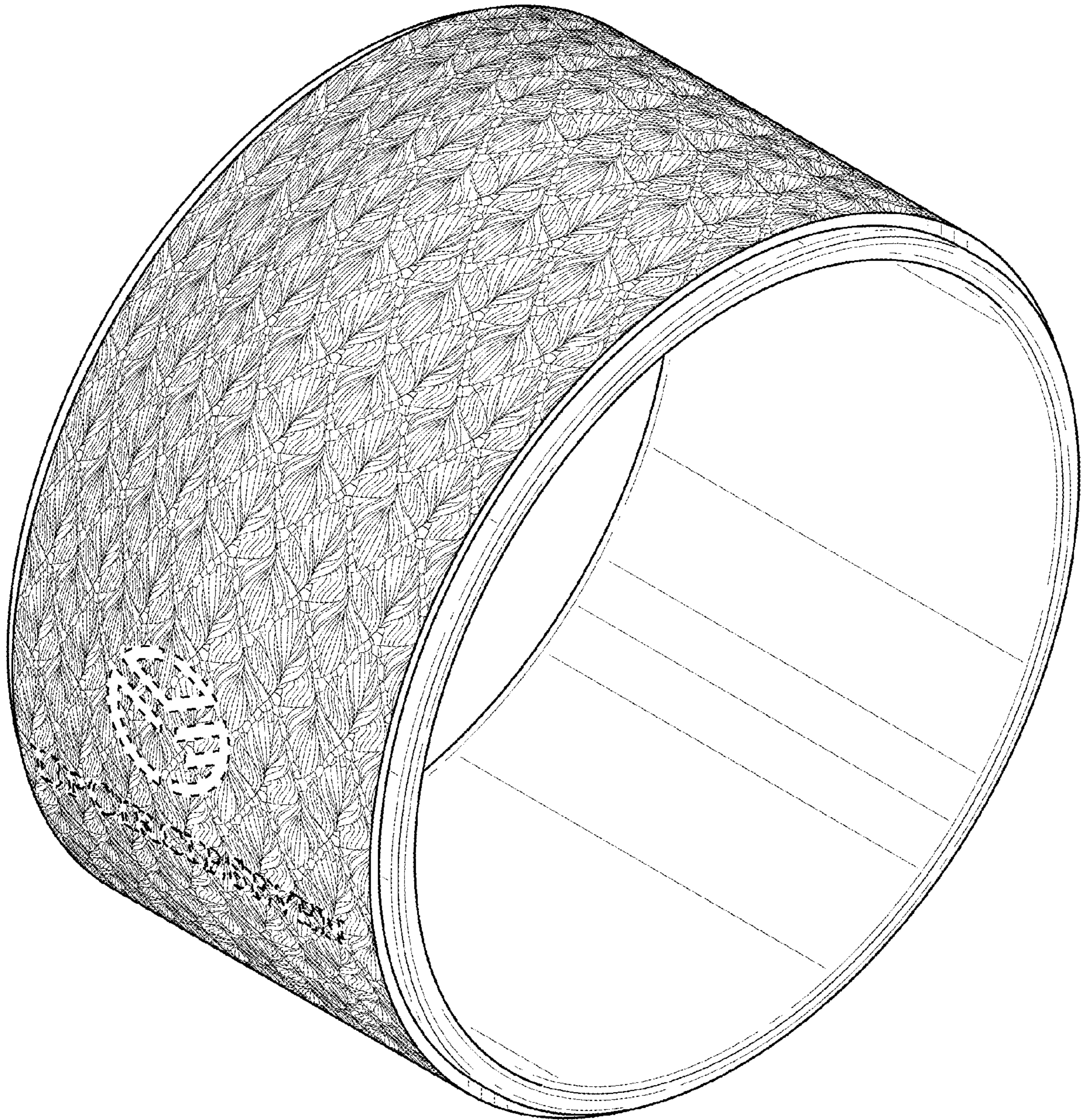

FIG. 1

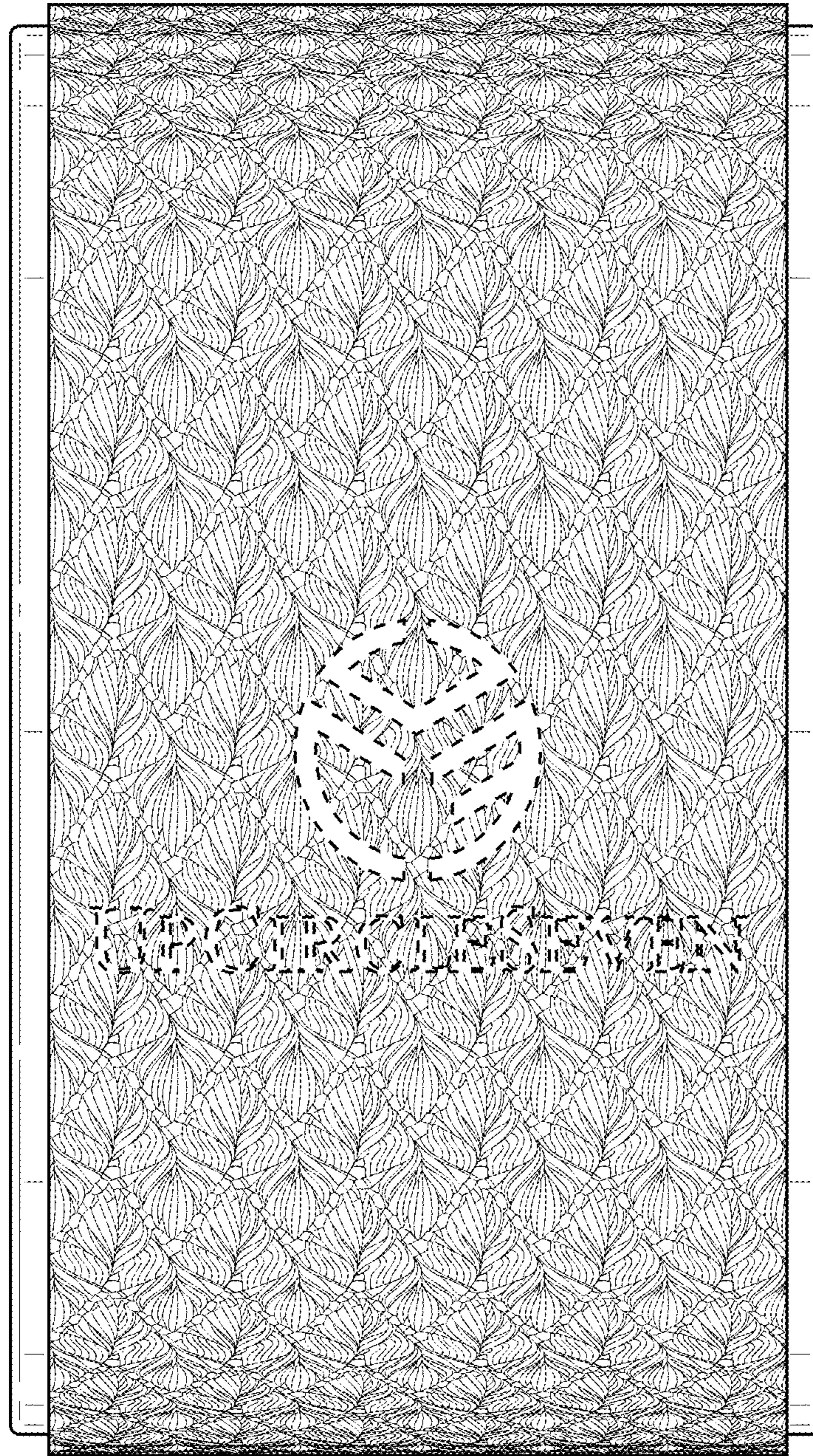

FIG. 2

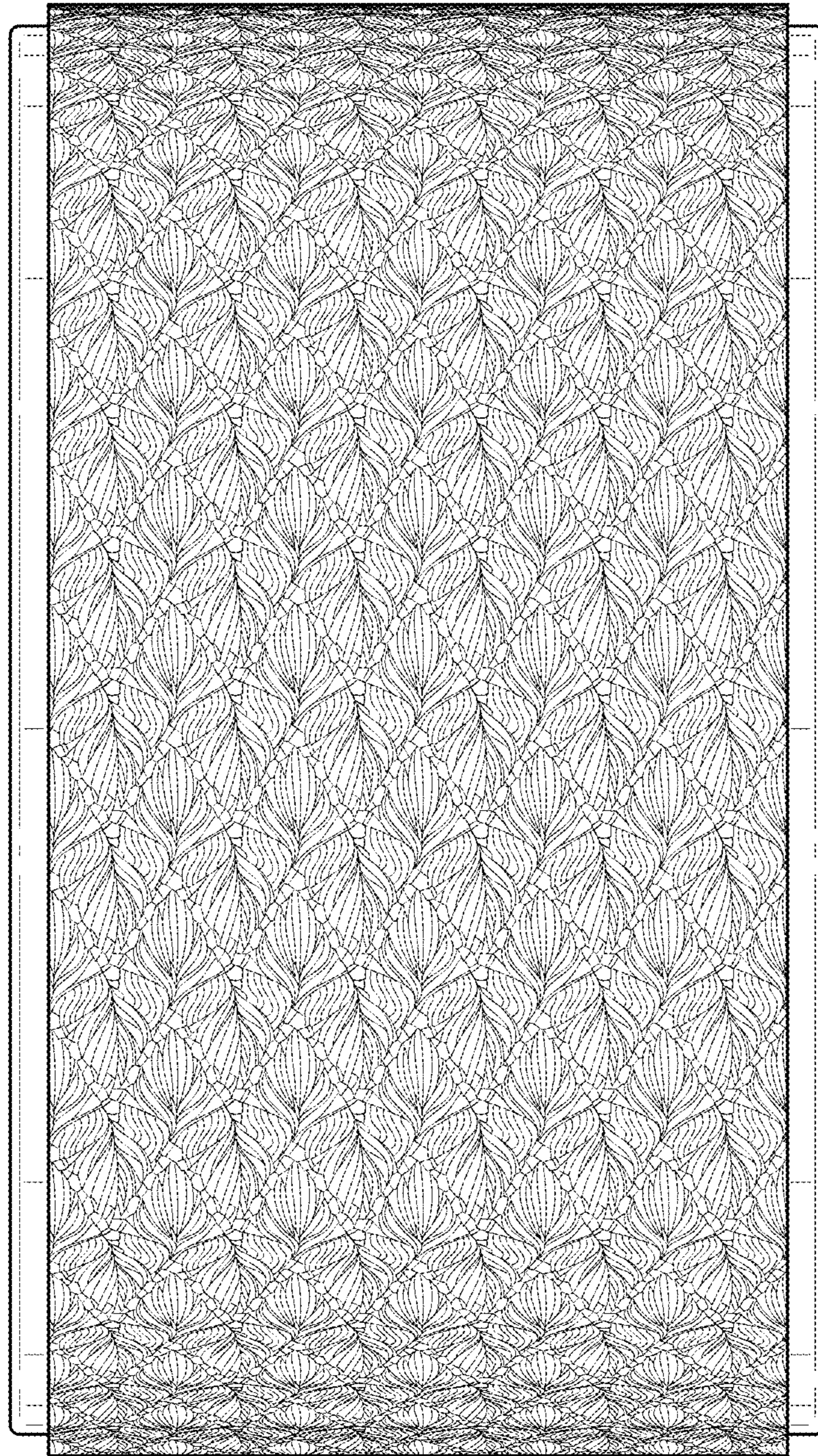

FIG. 3

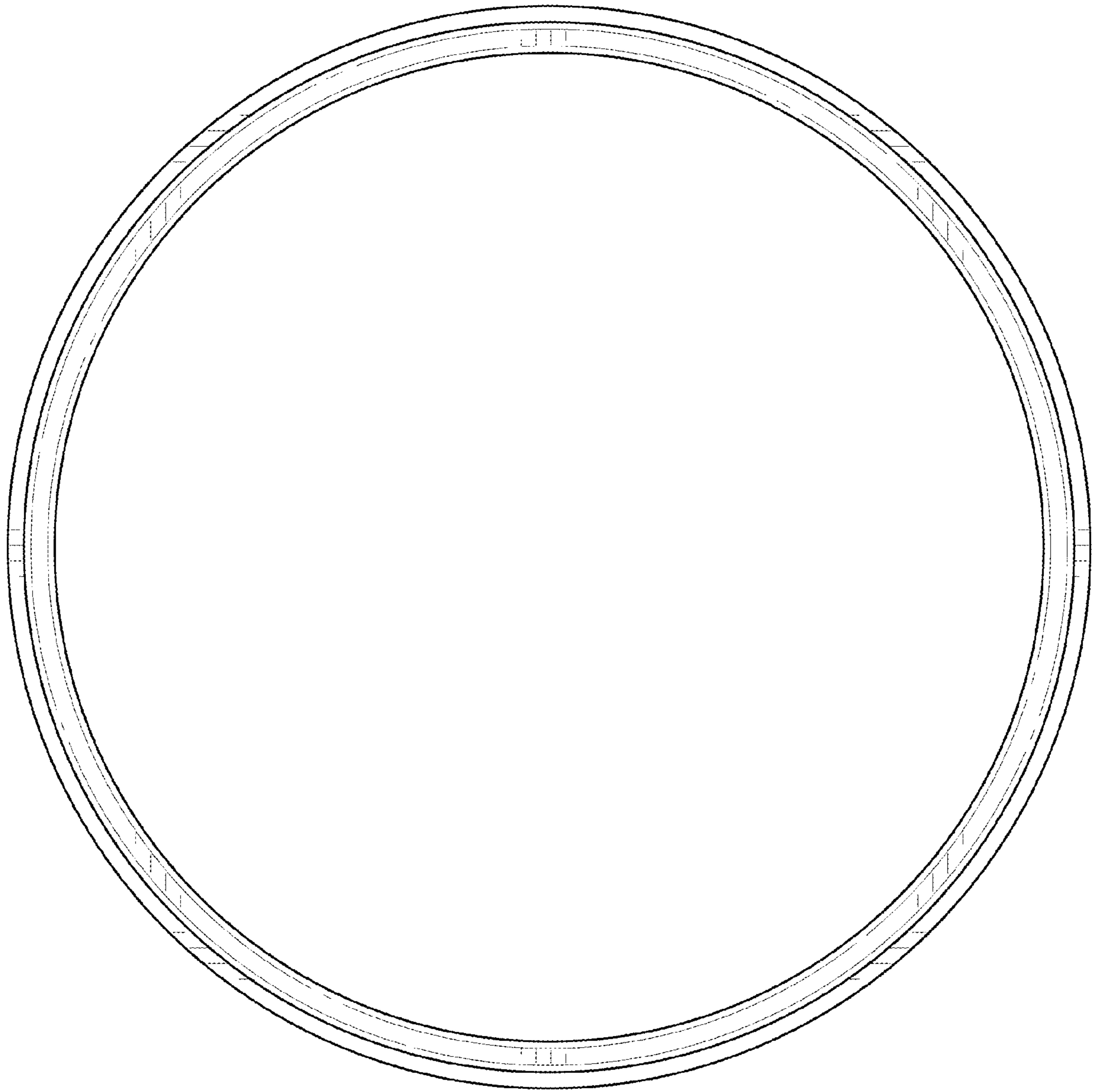

FIG. 4

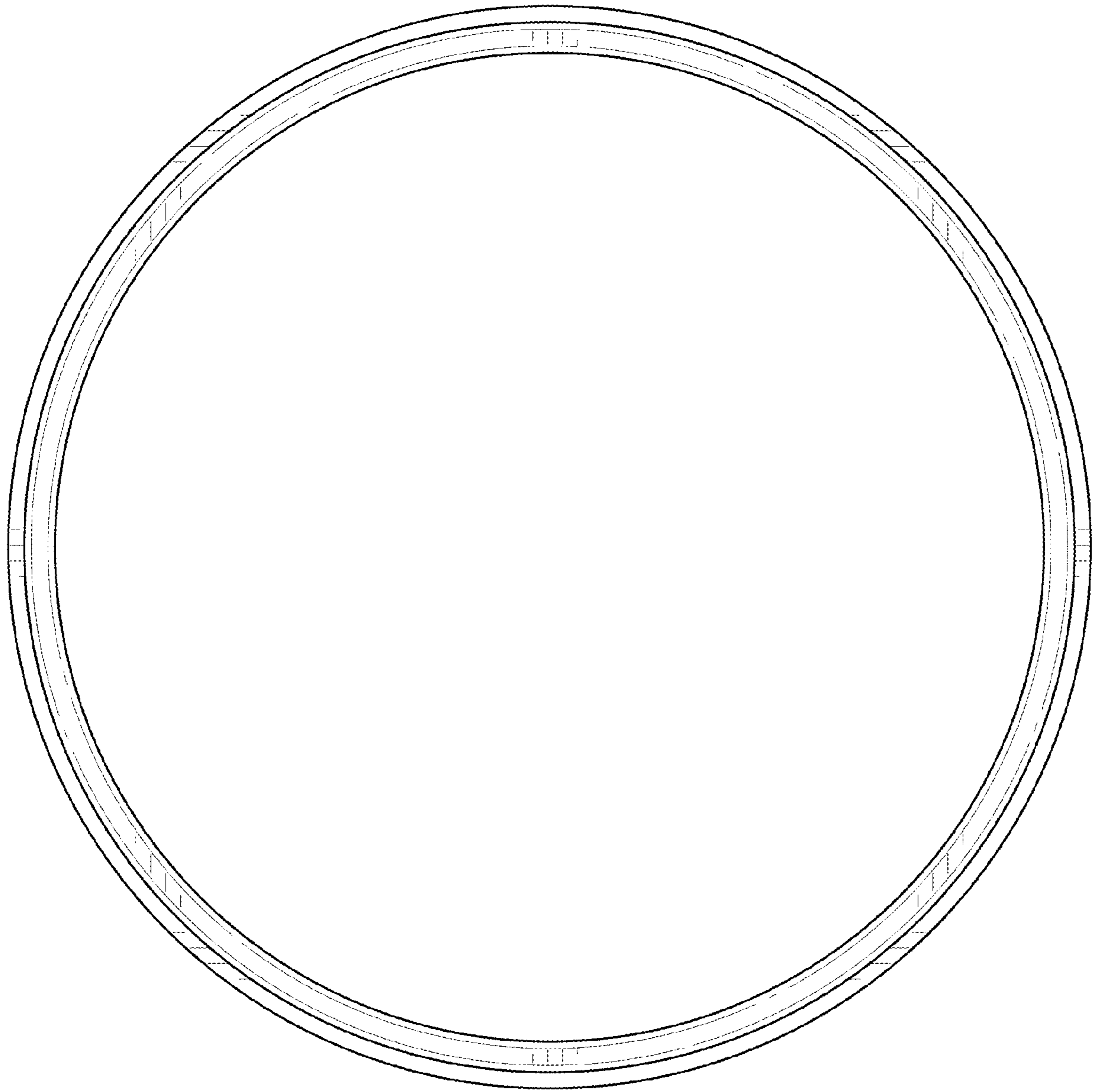

FIG. 5

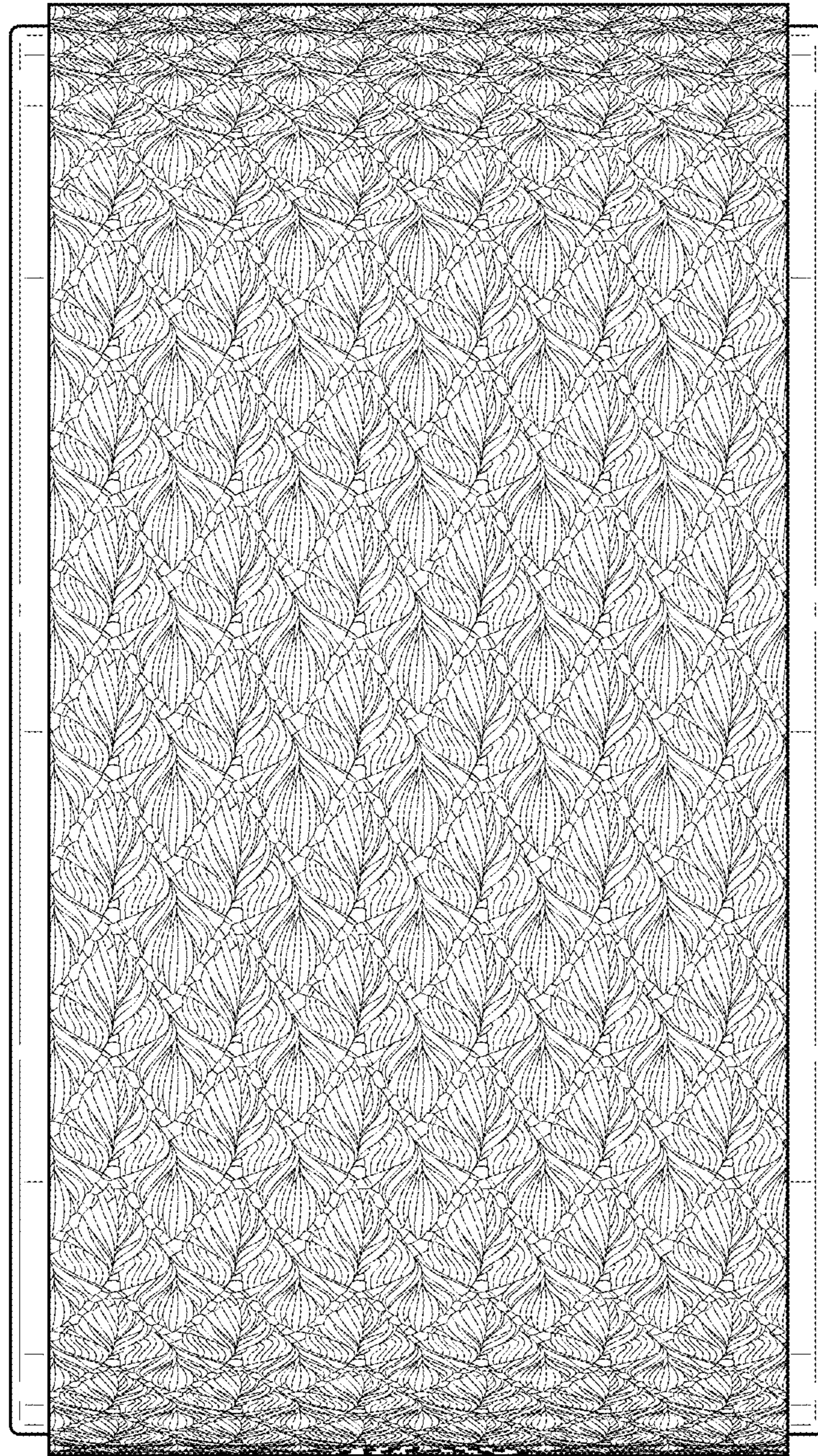

FIG. 6

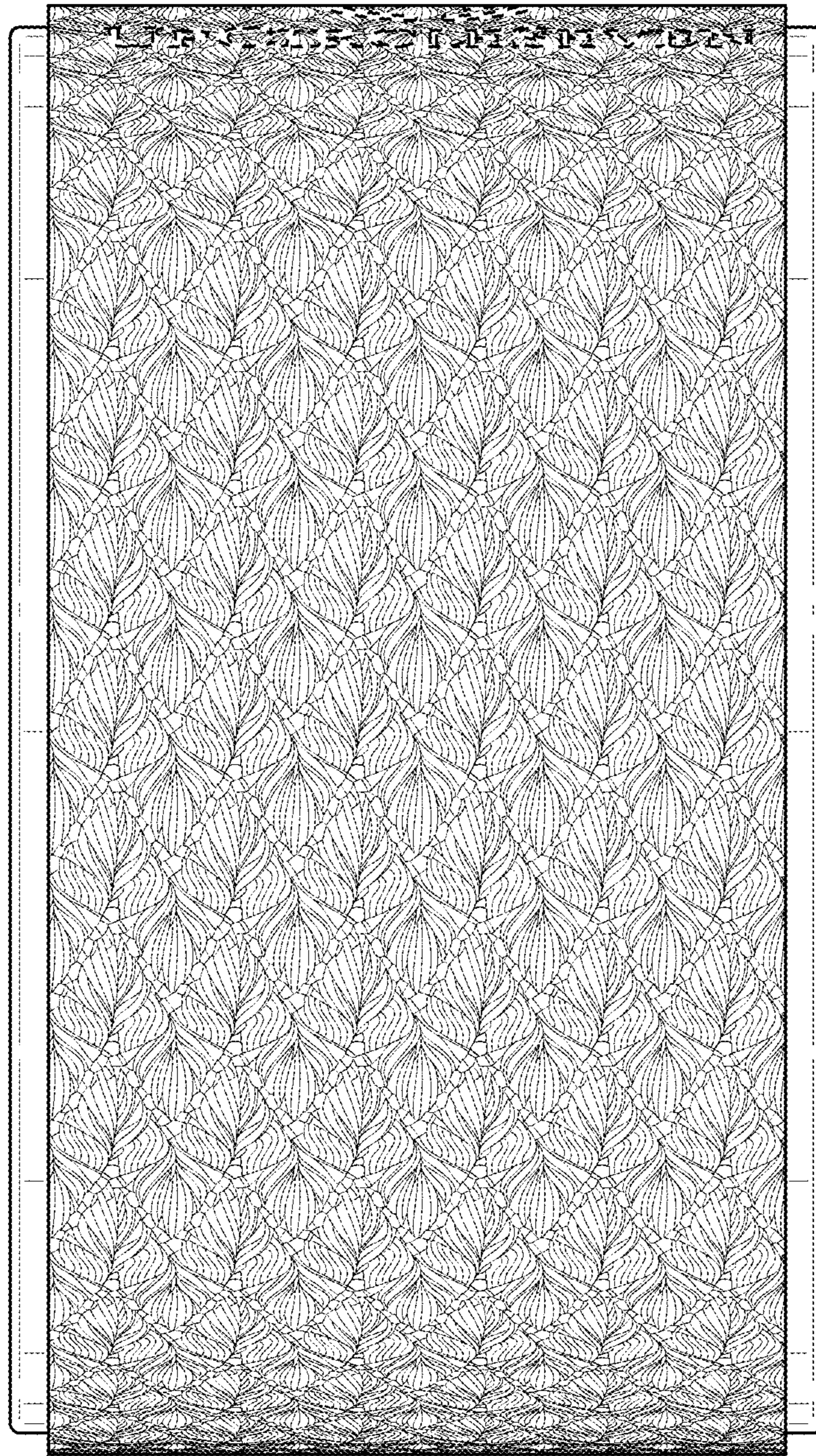

FIG. 7

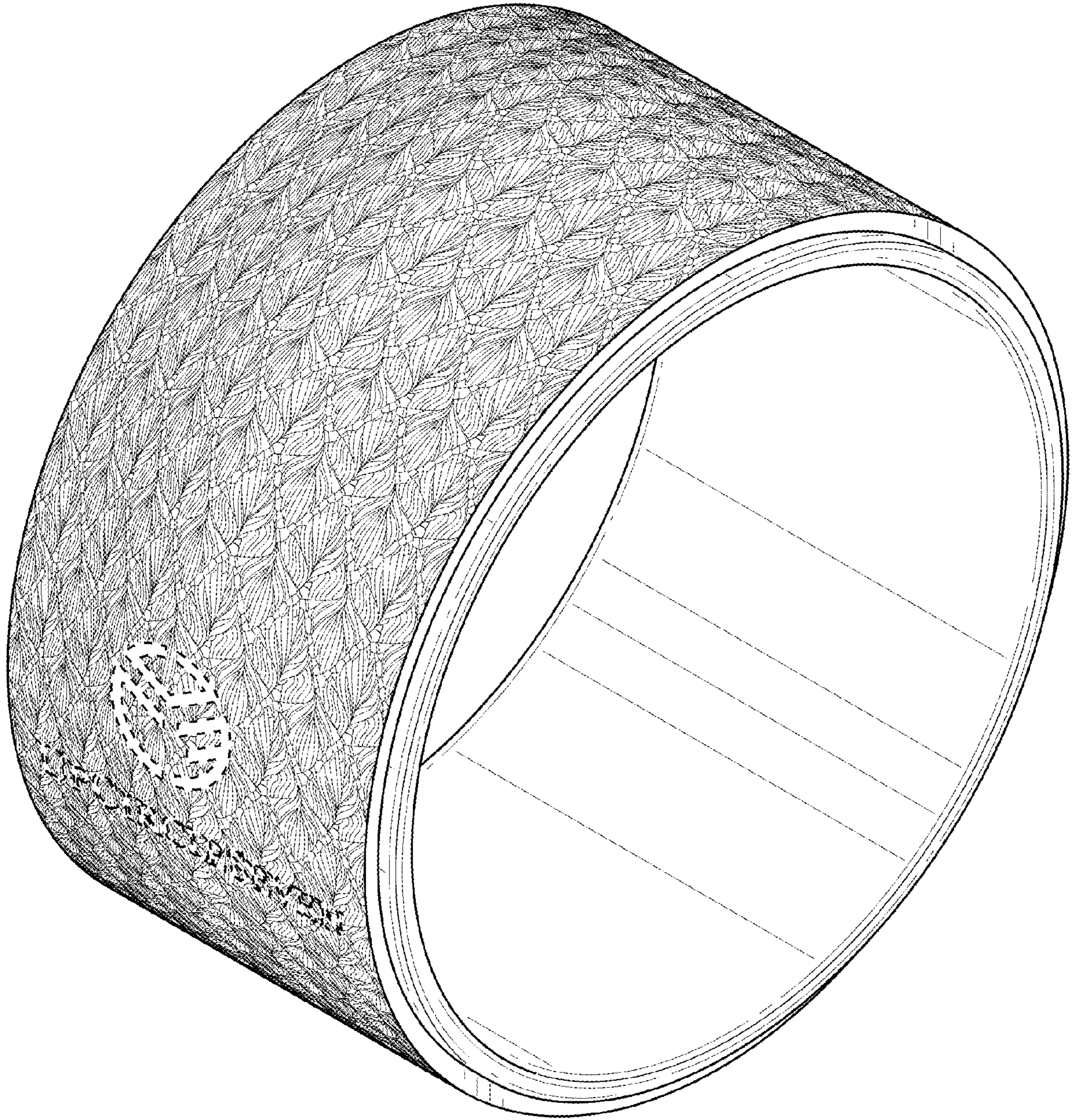

FIG. 8

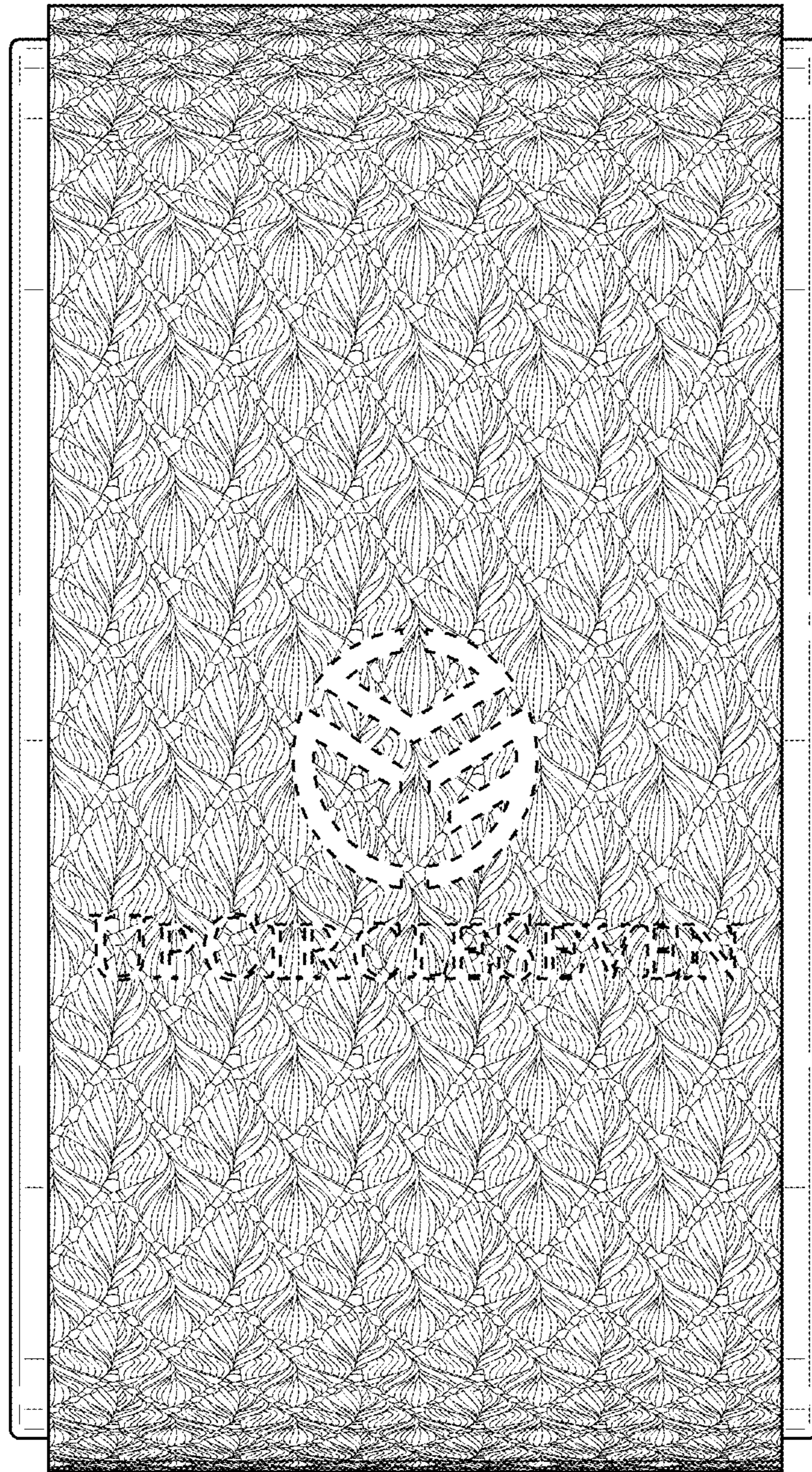

FIG. 9

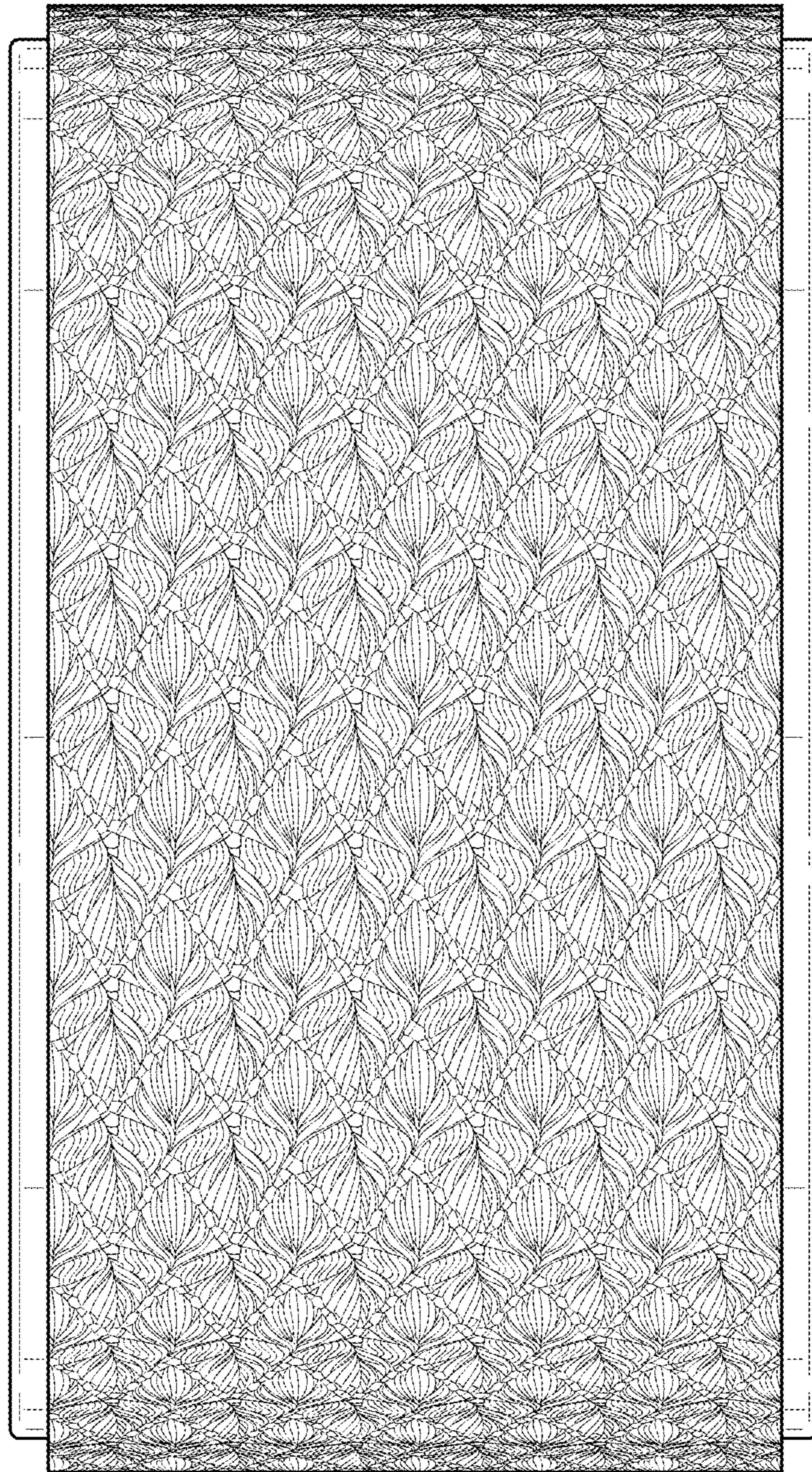

FIG. 10

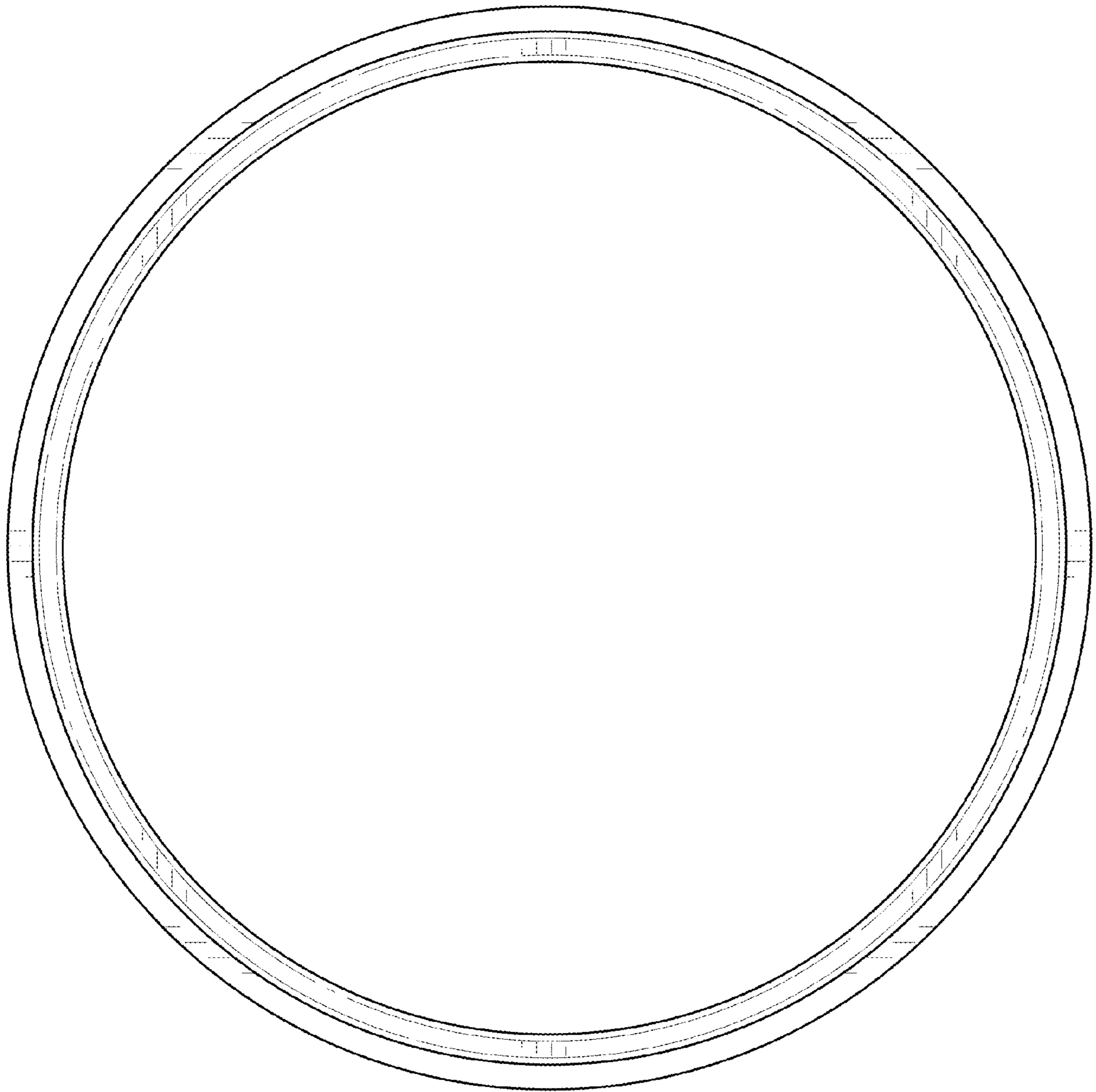

FIG. 11

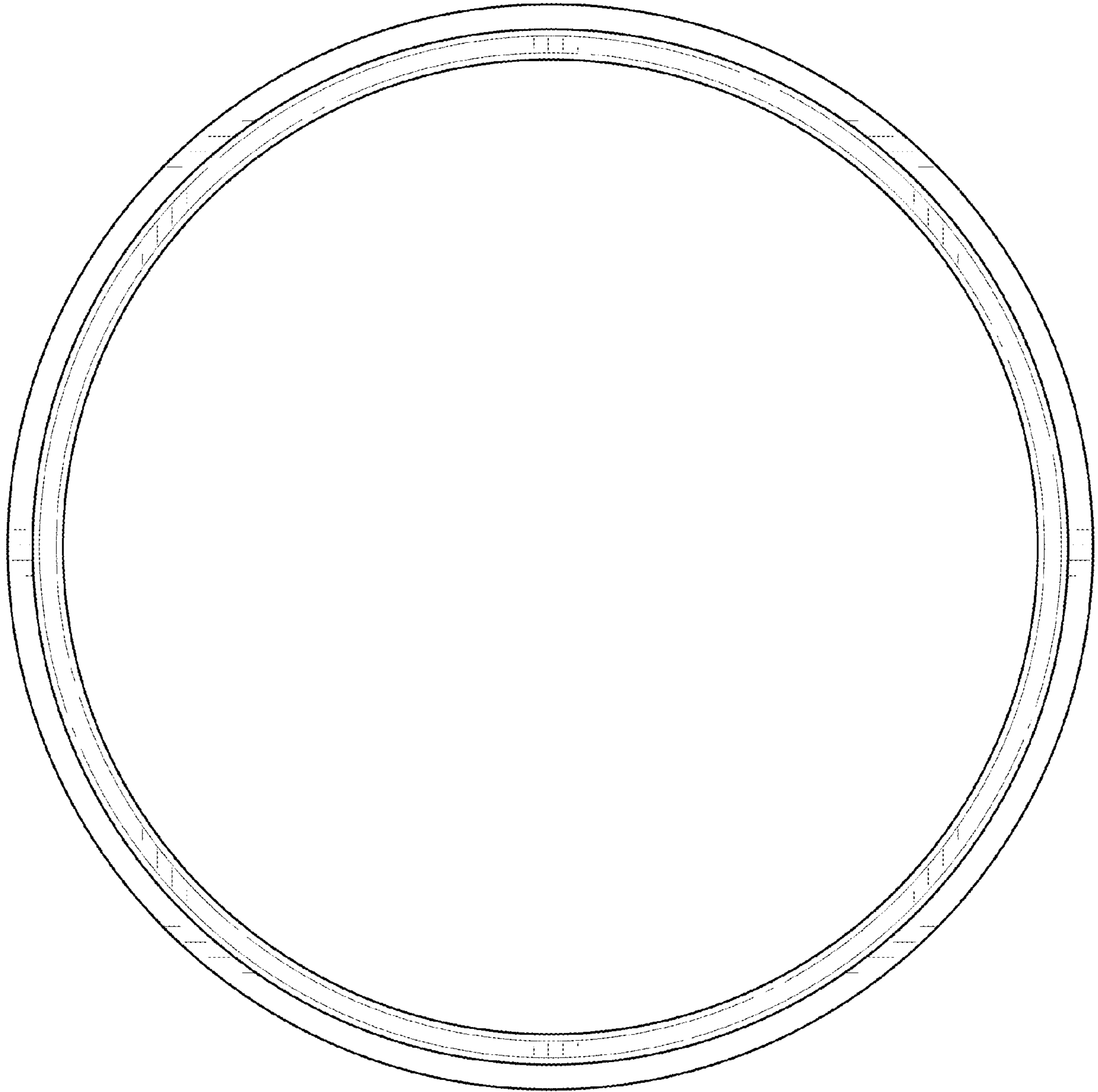

FIG. 12

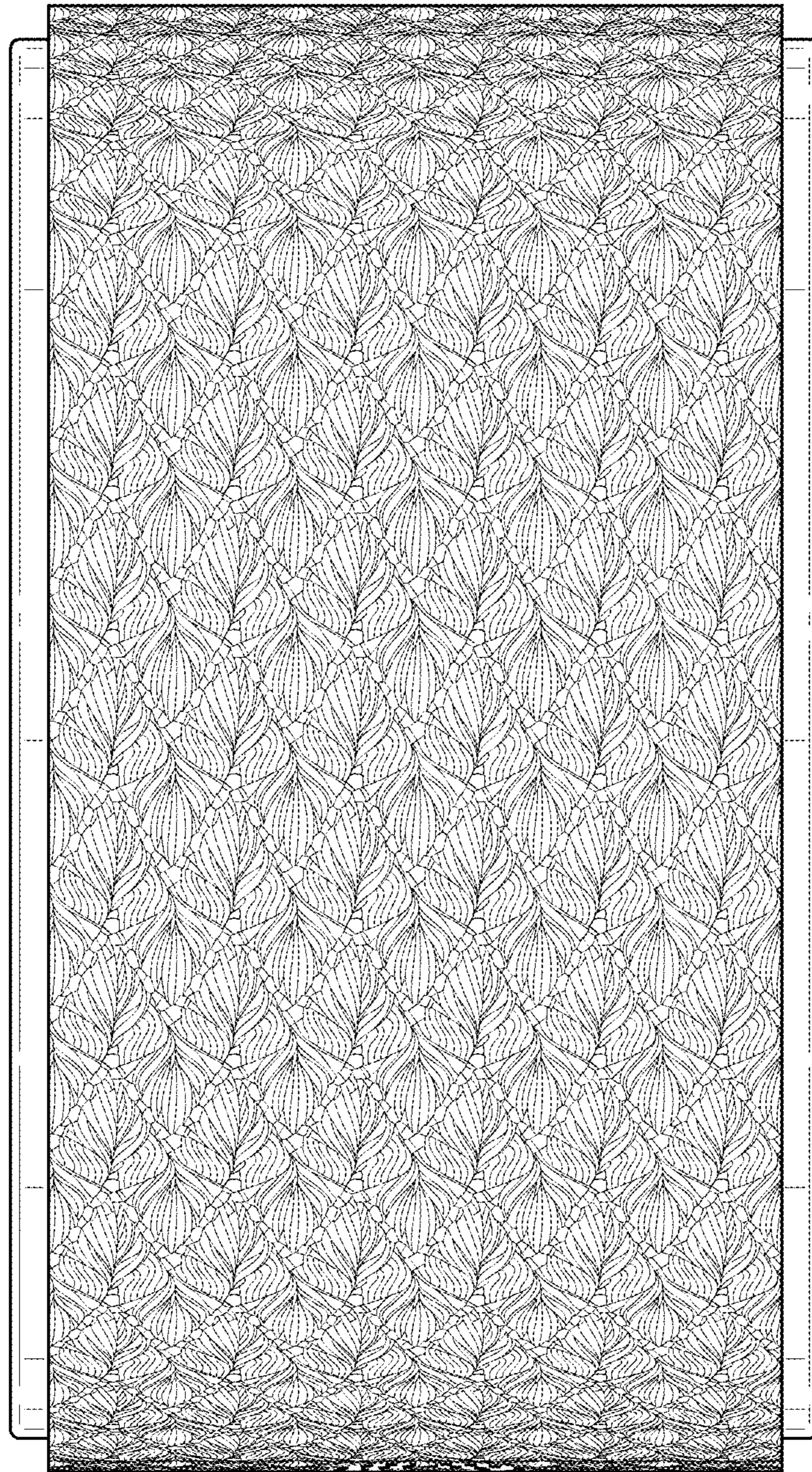

FIG. 13

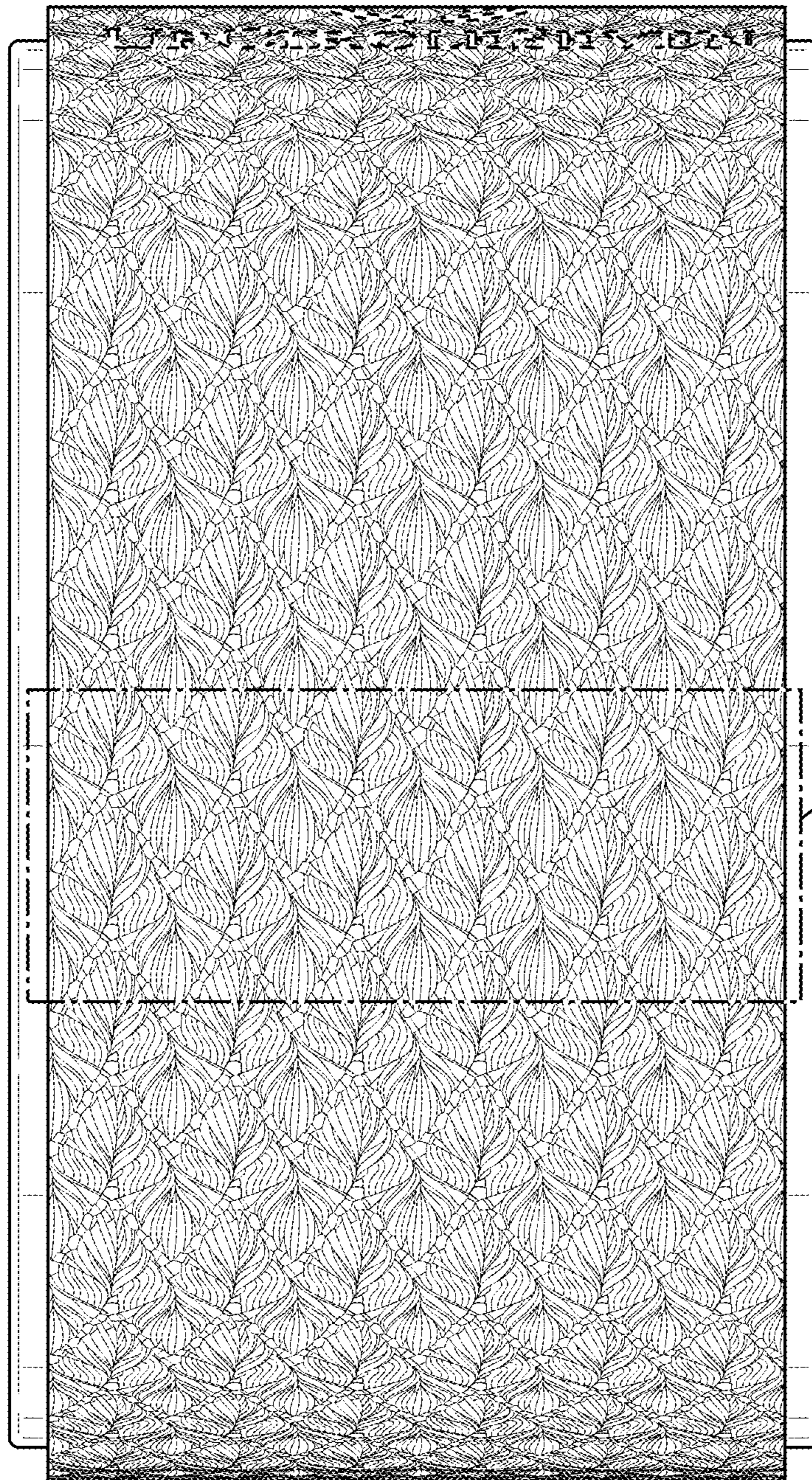

FIG. 15

FIG. 14

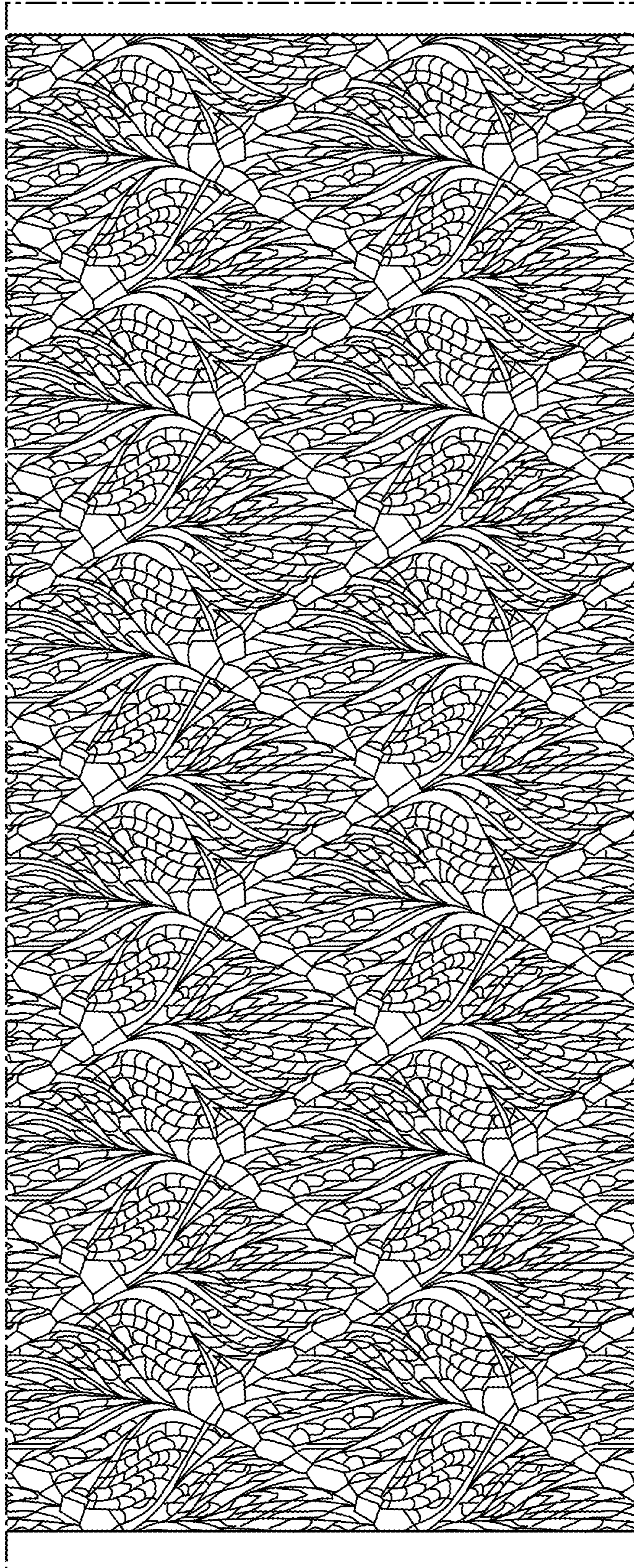

FIG. 15